

General-purpose filter

- current ratings from 1 to 60A
 - general-purpose filtering performance
 - optional medical versions (B types)
 - optional safety versions (A types)
-
- Nennströme von 1 bis 60A
 - Filterleistung für Universaleinsatz
 - Optionale medizinische Versionen (Typ B)
 - Optionale Sicherheitsversionen (Typ A)
-
- courants de service de 1 à 60A
 - filtrage universel
 - en option version pour appareils médicaux (type B)
 - en option version pour la sécurité (type A)



Filter selection table

Choose the filter FN xxxx-x with the required current rating and features, and add /?? to determine input/output (line/load) connection style. Example: FN 2010-10/06 is a 10A filter with fast-on connections.

Approvals



Filter	Connections			Current ratings at 40°C (25°) A	Inductance L mH	Capacitance		Resistance R MΩ	Housing	Weight g
	/06	/07	/08			Cx μF	Cy nF			
FN 2010-1 /??	/06	/07	-	1 (1.15)	12	0.1	4.7	1	F3	65
FN 2010-3 /??	/06	/07	-	3 (3.45)	2.5	0.1	4.7	1	F3	65
FN 2010-6 /??	/06	/07	-	6 (6.9)	1	0.1	4.7	1	F3	65
FN 2010-10 /??	/06	/07	-	10 (11.5)	0.8	0.1	4.7	1	F2	85
FN 2010-12 /??	/06	/07	-	12 (13.8)	0.7	0.1	4.7	1	F2	85
FN 2010-16 /??	/06	/07	-	16 (18.4)	0.65	0.1	4.7	1	H2	140
FN 2010-20 /??	/06	/07	/08	20 (23)	0.6	0.1	4.7	1	K1	210
FN 2010-30 /??	-	-	/08	30 (34.5)	0.67	0.47	10	1	P	470
FN 2010-60 /??	-	-	/24	60 (69)	1	1.5	10	0.33	L2	1100

Additional specifications

Filter type	Maximum operating voltage		Operating frequency Hz	Hipot test voltage		MTBF Per Mil-HB-217F at 40°C 230V hours	Maximum leakage mA/phase
	VAC	Hz		PN→E VAC	P→N VDC		
Standard types	250	50/60	DC to 400	2000	1700	800 000	0.4*
B medical types (no Y capacitors)	250	50/60	DC to 400	2500	1700	800 000	0.002
A safety types (lower capacitance)	250	50/60	DC to 400	2500	1700	800 000	0.040

* 1mA for 30A and 60A versions

Electrical schematic

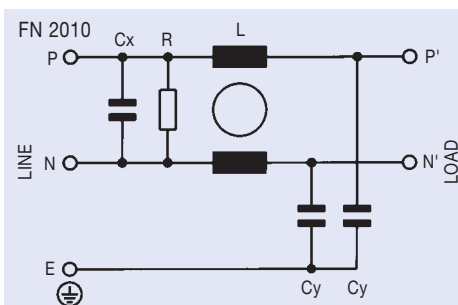

See tables for component values.

FN 2010 insertion loss

Per CISPR 17; A = 50Ω/50Ω sym, B = 50Ω/50Ω asym, C = 0.1Ω/100Ω sym, D = 100Ω/0.1Ω sym

1A types

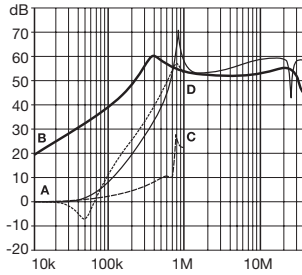

3A types

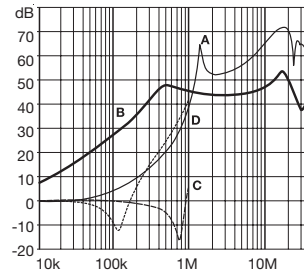

6A types

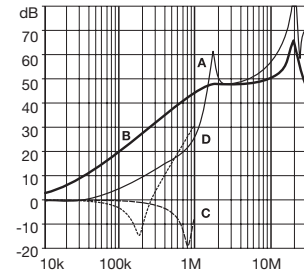

10A types (12A*)

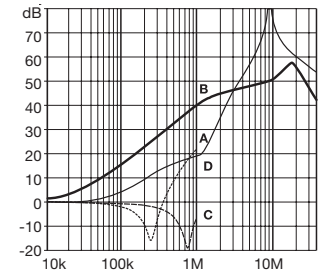

16A types

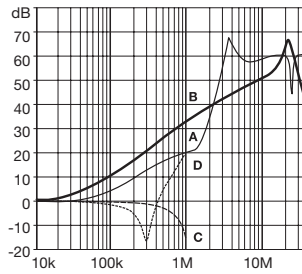

20A types

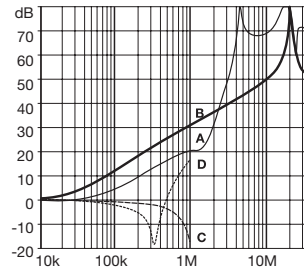

30A types

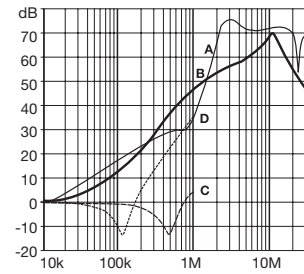

60A types

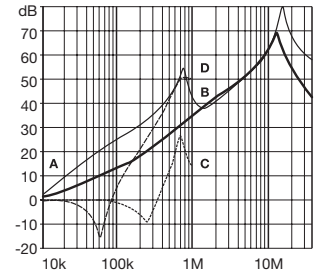

* attenuation performance of the 12A version is similar to the 10A component.

Mechanical data

Housing style	F2	F3	H2	K1	Tol.* ± mm
A	64 ± 0.3		71	85	± 0.5
B	35		46.6	54	± 0.5
C	29.3	24.3	29.3	30.3	± 0.5
D	43.5		50.5	64.8	± 0.5
F	54		61	75	± 0.3
J	21			27	± 0.2
K	8.3 [§] /9.3		10.8/8.3 [§]	12.3	± 0.5
L	15.3		19.3	20.8	± 0.5
M			5.3		± 0.1
N			6.3		± 0.1
P			0.7		± 0.1
S			20.1/30.5 [§]	19.9/21.4 ^{†§}	± 0.5

§ with /07 connections
 † with /08 connections
 wire length of /07: 140 +5 mm

* Measurements share this common tolerance unless otherwise stated.

Housing style	P	L2	Tol.* ± mm
A	113.5	105 ± 0.5	± 1
B	57.5	99.5	± 1
C	45.4 ± 1.2	57.6	± 1
D	94	84.5	± 1
F	103	95	± 0.3
J	25	40	± 0.2
K	12.4	10.1	± 0.5
L	32.4	20	± 0.5
M	4.4		± 0.1
N	6		± 0.1
P	0.9	79	± 0.1
R			± 0.2
S	15.5		± 0.5

* Measurements share this common tolerance unless otherwise stated.

FRONT

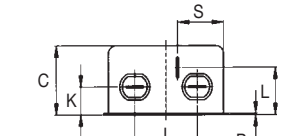
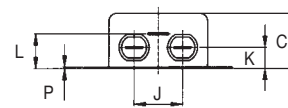

TOP

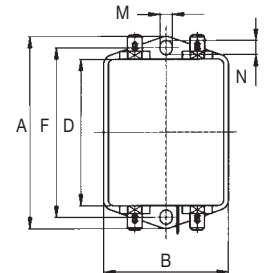
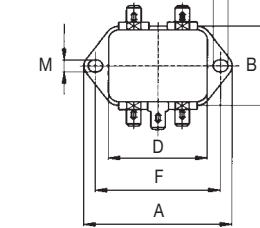

Housings F2, F3

Housings H2, K1

FRONT

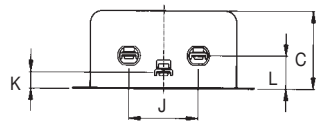
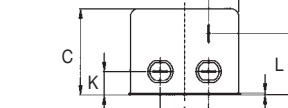

TOP

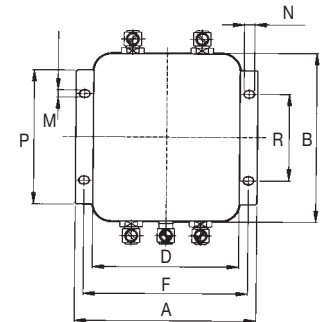
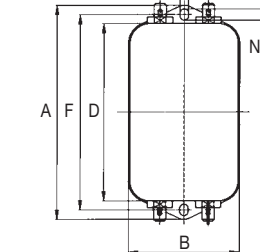

Housing P

Housing L2

All dimensions in mm; 1 inch = 25.4 mm