

Ultrasonic sensor UC2000-30GM-E6R2-V15



Features

- Parameterisation interface for the application-specific adjustment of the sensor setting via the service program ULTRA 2001
- 2 switch outputs freely adjustable
- Hysteresis mode selectable
- Window function can be selected
- Synchronisation options
- Adjustable acoustic power and sensitivity
- Temperature compensation

Electrical connection

Standard symbol/Connection:
(version E6, pnp)

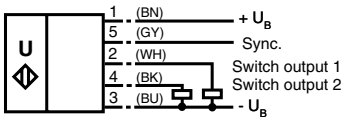

Core colours in accordance with EN 60947-5-2.

Connector V15



Dimensions

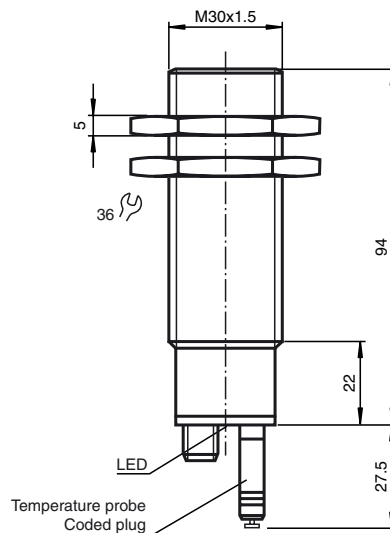

Technical data



General specifications

Sensing range	80 ... 2000 mm
Adjustment range	120 ... 2000 mm
Unusable area	0 ... 80 mm
Standard target plate	100 mm x 100 mm
Transducer frequency	approx. 180 kHz
Response delay	65 ms minimum 195 ms factory setting

Indicators/operating means

LED green	permanent: Power-on flashing: Standby mode or TEACH-IN function object detected
LED yellow 1	permanent: switching state switch output 1 flashing: TEACH-IN function
LED yellow 2	permanent: switching state switch output 2 flashing: TEACH-IN function
LED red	permanent: temperature/TEACH-IN plug not connected flashing: fault or TEACH-IN function object not detected
Temperature/TEACH-IN connector	temperature compensation, TEACH-IN of the switch points, output function setting

Electrical specifications

Operating voltage	10 ... 30 V DC, ripple 10 % _{SS}
No-load supply current I ₀	≤ 50 mA

Interface

Interface type	RS 232, 9600 Bit/s, no parity, 8 data bits, 1 stop bit
----------------	--

Input/Output

Synchronisation	bi-directional 0 level: -U _B ...+1 V 1 level: +4 V...+U _B input impedance: > 12 KOhm synchronisation pulse: ≥ 100 μs, synchronisation interpulse period: ≥ 2 ms
-----------------	---

Synchronisation frequency

Common mode operation	≤ 30 Hz
Multiplex operation	≤ 30/n Hz, n = number of sensors

Output

Output type	2 switch outputs pnp, NO/NC, parameterisable
Repeat accuracy	≤ 0,1 % of full-scale value
Rated operational current I _o	200 mA, short-circuit/overload protected
Voltage drop U _d	≤ 2,5 V
Switching frequency f	≤ 2,5 Hz
Range hysteresis H	1 % of the adjusted operating range (default settings), programmable
Temperature influence	≤ 2 % from full-scale value (with temperature compensation) ≤ 0.2 %/K (without temperature compensation)

Standard conformity

Standards	EN 60947-5-2
-----------	--------------

Ambient conditions

Ambient temperature	-25 ... 70 °C (248 ... 343 K)
Storage temperature	-40 ... 85 °C (233 ... 358 K)

Mechanical specifications

Protection degree	IP65
Connection	connector V15 (M12 x 1), 5 pin
Material	
Housing	stainless steel 1.4303 plastic parts PBT
Transducer	epoxy resin/hollow glass sphere mixture; polyurethane foam
Mass	140 g

Description of the sensor functions

This ultrasonic sensor features a four-pole temperature/TEACH-IN plug, that can be connected in four different positions. These have the following significance.

Plug position	Meaning
A1	TEACH-IN switching point A1
A2	TEACH-IN switching point A2
E2/E3	Switching: 2 independent switching points/window mode/hysteresis mode
T	Temperature compensation

Description of the TEACH-IN procedure

TEACH-IN of switching points 1 or 2

- Cut supply voltage
- Remove TEACH-IN plug
- Restore supply voltage (Reset)
- Set object to desired switching point
- Plug and remove the TEACH-IN plug in pos. A1 or A2. Switching point A1 or A2 is taught.

Caution: Removing the temperature/TEACH-IN plug, the values of the object position will be adopted.

- The TEACH-IN procedure is controlled with the LED. The green LED flashes, when object is detected, the red LED flashes when no object is detected.
- Connect TEACH-IN plug in pos. T. The TEACH-IN procedure is completed, the sensor is working in normal mode.

TEACH-IN of switching function

- Cut supply voltage
- Remove TEACH-IN plug
- Restore supply voltage (Reset)
- Connect TEACH-IN plug in pos. E2/E3. By multiple plugging, three different modes of operation can be set in cyclical sequence:
 - switching point mode, LED A1 is flashing,
 - window mode, LED A2 is flashing
 - hysteresis mode, LED A1 and A2 are flashing
- Connect TEACH-IN plug in pos. T. The TEACH-IN procedure is completed, the sensor is working in normal mode.

Note: If the temperature/TEACH-IN plug has not been plugged in within 5 minutes in position T, the sensor will return to normal mode (with the latest permanent stored values) without temperature compensation.

Synchronisation

The sensor features a synchronisation input for the suppression of mutual interference. If this input is not used, the sensor will operate using an internally generated clock rate. It can be synchronised by applying a square wave voltage. A falling edge leads to the transmission of a single ultrasonic pulse. A low level ≥ 1 s or an open synchronisation input will result in the normal operation of the sensor.

A high level > 1 s will result in the standby mode of the sensor (indicator green LED). The outputs pause in the latest status.

Synchronisation cannot be performed during TEACH-IN and vice versa.

Multiple operating modes are possible

- Two to five sensors can be synchronised by interconnecting their synchronisation inputs. In this case, the sensors alternately transmit ultrasonic pulses.
- Multiple sensors can be controlled by the same synchronisation signal. The sensors are synchronised.
- The synchronisation pulses are sent cyclically to individual sensors. The sensors operate in multiplex mode.
- A high level at the synchronisation input disables the sensor.

The response time increases when the sensor is synchronised, because the synchronisation increases the measurement cycle time.

Note:

If the option for synchronisation is not used, the synchronisation input has to be connected to ground (0V) or the sensor has to be operated via a V1 cable connector (4-pin).

Default setting

- A1: unusable area
A2: nominal sensing range

UC2000-30GM-E6R2-V15

Characteristic curves/additional information

Characteristic response curve

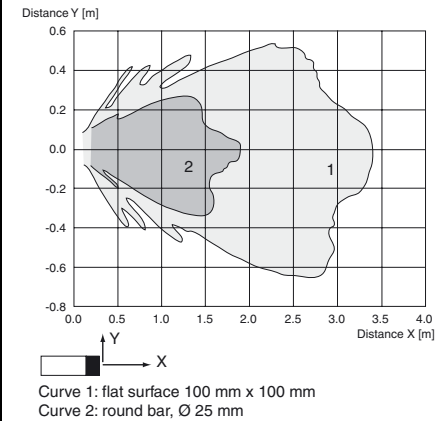

Possible operating modes

1. Switch point mode

When $A1 < A2$, both switch outputs are activated as N.O. contacts.

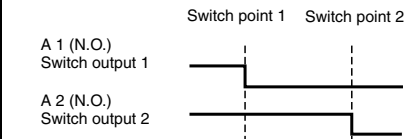

When $A1 > A2$, both switch outputs are activated as N.C. contacts.

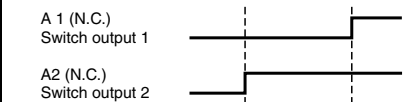

2. Window mode

To exchange the switching distances is of no effect.

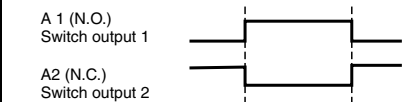

3. Hysteresis mode

To exchange the switching distances is of no effect.

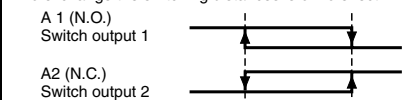

LED Displays

Displays in dependence on operating mode	Dual LED green	LED red	LED yellow A1	LED yellow A2
TEACH-IN of switching point A1 object detected no object detected	flashing off	off flashing	flashing flashing	off off
TEACH-IN switching point A2 object detected no object detected	flashing off	off flashing	off off	flashing flashing
TEACH-IN mode of operation (E2/E3) two independent switching points window mode Hysteresis mode	on on on	off off off	flashing off flashing	off flashing flashing
Normal mode temperature compensated plug pulled or shorted	on off	off on	switching state A1 switching state A1	switching state A2 switching state A2
Interference (e.g. compressed air)	off	flashing	last or defined condition	last or defined condition
Standby	flashes	off	previous state	previous state

LED ON indicates closed switch output.

LED-Window

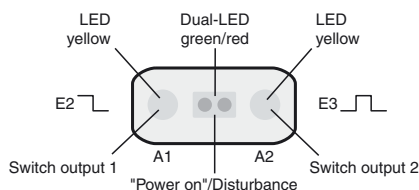

RS 232-connection

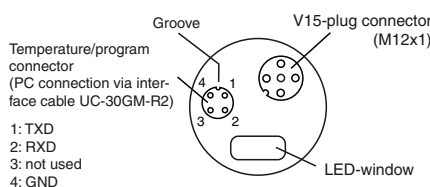

Note on communication with the UC-30GM-R2 interface cable

The UC-30GM-R2 interface cable allows for communication with the ultrasonic sensor using the ULTRA 2001 service program. The cable creates a connection between the PC-internal RS 232 interface and the plug-in connection for the temperature/program plug on the sensor. When setting up the connection on the sensor, make certain the plug is lined up correctly; otherwise no communication will be possible. The protrusion of the round plug must be inserted into the groove of the plug connection on the sensor side and **not** into the arrow symbol on the sensor.

Adjustable parameter with service program ULTRA 2001

- Switching point 1 and 2
- NO/NC function
- Mode of operation
- Sonic speed
- Temperature offset (The inherent temperature-rise of the sensor can be considered in the temperature compensation)
- Expansion of the unusable area (for suppression of unusable area echoes)
- Reduction of the detection range (for suppression of remote range echoes)
- Time of measuring cycle
- Acoustic power (interference of the burst duration)
- Sensitivity
- Behaviour of the sensor in case of echo loss
- Behaviour of the sensor in case of a fault
- Average formation via an allowed number of measuring cycles
- On/off-delay
- Switching hysteresis
- Selection of the parameter set, RS 232 or manually.

Accessories

Mounting aids

- BF30
- BF30F
- BF5-30
- M-105

Sound deflectors

UVW90-M30

UVW90-K30

External temperature probe

UC-30GM-TEMP

Extension cable

UC-30GM-PROG

Programming tools

Service program ULTRA 2001

Interface cable UC-30GM-R2

Cable sockets *)

V15-G-2M-PVC

V15-W-2M-PUR

*) For additional cable sockets see section „Accessories“.

Mounting conditions

If the sensor is installed in places where the operating temperature can fall below 0 °C, the BF30, BF30-F or BF 5-30 fixing clamp must be used.