

# EMI

CATALOG

www.lairdtech.com



# ABOUT LAIRD

Laird is a global technology business focused on enabling wireless communication and smart systems, and providing components and systems that protect electronics. Laird operates through two divisions, Wireless Systems and Performance Materials. Wireless Systems solutions include antenna systems, embedded wireless modules, telematics products and wireless automation and control solutions. Performance Materials solutions include electromagnetic interference shielding, thermal management and signal integrity products. As a leader in the design, supply and support of innovative technology, our products allow people, organisations, machines and applications to connect effectively, helping to build a world where smart technology transforms the way of life. Custom products are supplied to major sectors of the electronics industry including the handset, telecommunications, IT, automotive, public safety, consumer, medical, rail, mining and industrial markets. Providing value and differentiation to our customers through innovation, reliable fulfilment and speed, Laird PLC is listed and headquartered in London, and employs over 9,000 people in more than 58 facilities located in 18 countries.



# TABLE OF CONTENTS

<b>EMI INTRODUCTION</b>	2	Fiber Optic Shield	40
<b>EMI SUMMARY</b>	3	GBIC Fiber Optic Shield	40
<b>BOARD LEVEL SHIELDS</b>	6	"D" Connector Shielding / Slotted "D"	41
Product Selection Guide	6	Precision Stamped Metals	42
Introduction	8	Contacts	42
Standard Design Shields	9	Custom Design	44
EZ Peel™	11	Metals Galvanic Compatibility Chart	46
Rigid Corner	11	<b>VENT PANELS</b>	48
ReCovr™	12	MaxAir™	49
ReMovl	12	Electro-Air™	50
Overview	13	Electrovent™	51
<b>FINGERSTOCK</b>	14	<b>FABRIC-OVER FOAM</b>	52
Product Selection Guide	14	Product Selection Guide	52
Introduction	15	Introduction	54
Mounting Methods	16	EcoGreen™	56
Ordering Information	17	I/O / Gasket Selection Guide	57
UltraSoft® Series	18	Profile Selection Guide	58
Recyclable Clean Copper	18	I/O Selection Guide	62
Slot Mount Series	19	Knitted Conductive Gaskets	65
Dual Slot Series	21	Visual Part Reference Guide	66
Teardrop Series	21	Part Number Cross Reference	67
Compact PCI Symmetrical Mount	22	Ultraflex®	68
Alternate Slot Series	22	All Mesh	69
Variable Slot Mount	23	Elastomer Core	70
Symmetrical (S <sup>3</sup> ) Slotted Shielding	24	Electroground® EMI Washers	72
Solid Top (S <sup>3</sup> ) Symmetrical Slotted Shielding	25	Electromesh® Tape	75
Clip-On Symmetrical Shielding	26	Conductive Fabric	76
No Snag Gasket	27	MRI "A" Fabric	77
All-Purpose Series	28	Conductive Tape	78
Clip-On Series	29	<b>ELECTRICALLY CONDUCTIVE ELASTOMERS</b>	79
Low Profile Hook-On Gasket	31	Introduction	79
Low Profile Gasket	31	Product Selection Guide	80
Large Enclosure Series	32	Case Study	81
Double-Sided Contact Series	32	Visual Part Reference Guide	85
Foldover Series	33	Electroseal™ Conductive Elastomer	86
Stainless Steel I/O Shielding	33	Extrusions Guide	87
Flexible Low Compression Series	34	Gemini™ Coextrusions	93
Clip-On Twist Series	34	Fabricated Components Guide	95
Twist Series	35	Metal Impregnated Materials	99
Divider Edge Shielding	35	Specialty Products	102
Card Guide Clip-On	36	Automated Form-In-Place Gaskets	103
Clip-On Perpendicular Shielding	36	<b>MICROWAVE ABSORBERS</b>	105
Clip-On Perpendicular Grounding Strip	37	Product Selection Guide	105
Clip-On Longitudinal Grounding Strip	37	Design Guide	106
Mini-Longitudinal Grounding Gasket	38	Q-Zorb® 2000 HF	109
Longitudinal Grounding Series	38	Q-Zorb® 3000 HP	110
Custom Stamping	39	RFRET 4000	111
Contact Strips / Contact Rings	39	RFLS 5000	112
IEEE 1394 Horizontal Connector Gasket	39	Analysis, Test and Prototype Development	113
DIN Connector Series	39		
USB Connector	40		

# TABLE OF CONTENTS

<b>EMI INTRODUCTION</b>	2	Fiber Optic Shield	40
<b>EMI SUMMARY</b>	3	GBIC Fiber Optic Shield	40
<b>BOARD LEVEL SHIELDS</b>	6	"D" Connector Shielding / Slotted "D"	41
Product Selection Guide	6	Precision Stamped Metals	42
Introduction	8	Contacts	42
Standard Design Shields	9	Custom Design	44
EZ Peel™	11	Metals Galvanic Compatibility Chart	46
Rigid Corner	11	<b>VENT PANELS</b>	48
ReCovr™	12	MaxAir™	49
ReMovl	12	Electro-Air™	50
Overview	13	Electrovent™	51
<b>FINGERSTOCK</b>	14	<b>FABRIC-OVER FOAM</b>	52
Product Selection Guide	14	Product Selection Guide	52
Introduction	15	Introduction	54
Mounting Methods	16	EcoGreen™	56
Ordering Information	17	I/O / Gasket Selection Guide	57
UltraSoft® Series	18	Profile Selection Guide	58
Recyclable Clean Copper	18	I/O Selection Guide	62
Slot Mount Series	19	Knitted Conductive Gaskets	65
Dual Slot Series	21	Visual Part Reference Guide	66
Teardrop Series	21	Part Number Cross Reference	67
Compact PCI Symmetrical Mount	22	Ultraflex®	68
Alternate Slot Series	22	All Mesh	69
Variable Slot Mount	23	Elastomer Core	70
Symmetrical (S <sup>3</sup> ) Slotted Shielding	24	Electroground® EMI Washers	72
Solid Top (S <sup>3</sup> ) Symmetrical Slotted Shielding	25	Electromesh® Tape	75
Clip-On Symmetrical Shielding	26	Conductive Fabric	76
No Snag Gasket	27	MRI "A" Fabric	77
All-Purpose Series	28	Conductive Tape	78
Clip-On Series	29	<b>ELECTRICALLY CONDUCTIVE ELASTOMERS</b>	79
Low Profile Hook-On Gasket	31	Introduction	79
Low Profile Gasket	31	Product Selection Guide	80
Large Enclosure Series	32	Case Study	81
Double-Sided Contact Series	32	Visual Part Reference Guide	85
Foldover Series	33	Electroseal™ Conductive Elastomer	86
Stainless Steel I/O Shielding	33	Extrusions Guide	87
Flexible Low Compression Series	34	Gemini™ Coextrusions	93
Clip-On Twist Series	34	Fabricated Components Guide	95
Twist Series	35	Metal Impregnated Materials	99
Divider Edge Shielding	35	Specialty Products	102
Card Guide Clip-On	36	Automated Form-In-Place Gaskets	103
Clip-On Perpendicular Shielding	36	<b>MICROWAVE ABSORBERS</b>	105
Clip-On Perpendicular Grounding Strip	37	Product Selection Guide	105
Clip-On Longitudinal Grounding Strip	37	Design Guide	106
Mini-Longitudinal Grounding Gasket	38	Q-Zorb® 2000 HF	109
Longitudinal Grounding Series	38	Q-Zorb® 3000 HP	110
Custom Stamping	39	RFRET 4000	111
Contact Strips / Contact Rings	39	RFLS 5000	112
IEEE 1394 Horizontal Connector Gasket	39	Analysis, Test and Prototype Development	113
DIN Connector Series	39		
USB Connector	40		

# EMI INTRODUCTION

## Overview of EMC/RFI Issues

The phenomenon of electromagnetic interference (EMI) is familiar to virtually everyone, even if they do not understand the underlying principles. Most people have witnessed firsthand the effects of interference. To control EMI, government organizations, such as the FCC, CSA, and EEC, mandate that manufacturers may not design, produce or sell electronic equipment that jams the public broadcast services. In other instances, however, EMI can constitute more than a mere nuisance. The military and medical communities, for example, require trouble-free operation of their electronic equipment in adverse electromagnetic environments since malfunctions could jeopardize missions and personnel. The European Union's EMC directive also mandates that "the apparatus has an adequate level of intrinsic immunity to electromagnetic disturbance to enable it to operate as intended".

## EMC Design of High Speed Systems

The interference and susceptibility (immunity) effects of electronic apparatus are created by time-variant electromagnetic fields which may be propagated along a conducting medium or by radiation through space. Because the source of the conducted and radiated interference energy levels may be related, a coordinated systems design effort is required to reduce these effects.

A design program for an equipment item that must meet both an emission and an immunity requirement consists of:

- Suppression: Reducing the interference at its source.
- Isolation: Isolating the offending circuits by filtering, grounding and shielding.
- Desensitization: Increasing the immunity of any susceptible circuits.

These three steps should be carried on throughout the entire equipment design and implemented as early as possible within the design program.

## Effects of Logic Speed

The trend in today's electronic devices is faster, smaller, and digital rather than analog. Most equipment (95%) of today contains digital circuits. Today's digital designer must create a circuit board that has the lowest possible EMI, combined with the highest possible operating/processing speeds. Design of the PCB is the most critical EMC influencing factor for any system, since virtually all active devices are located on the board. It is the changing current (accelerated electron movement) produced by the active devices that result in EMI.

## Design Approaches

There are two approaches that can be used to reduce the emission from the PC board. The first approach is to operate the circuit at the slowest speeds consistent with the functionality of the system, lay out the PCB with the smallest possible loop areas (especially the high speed devices), and insert suppression components such as filters, ferrite beads, and bypass capacitors into the circuit to reduce its bandwidth. These techniques will result in a desired decrease in the high frequency harmonic amplitudes and circuit bandwidth and a corresponding undesired decrease in both the operating speed and system reliability. The use of slower speeds with reduced bandwidth will help to desensitize the circuit to external susceptibility fields.

The second is to use shielding. Shielding is the only non-invasive suppression technique. Since the shielding is not inserted into the circuit, it does not affect the high frequency operating speed of the system, nor does it affect the operation of the system should changes be made to the design in the future. In addition, shielding does not create timing problems and waveform distortion; it does not decrease system reliability; and it reduces crosstalk. Plus, shielding works for both emission suppression as well as susceptibility (immunity) problems.

Even with the overall advantages of shielding, the most cost-effective approach is to use a combination of circuit suppression/hardening and shielding.

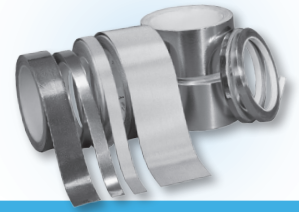
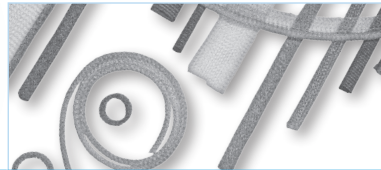
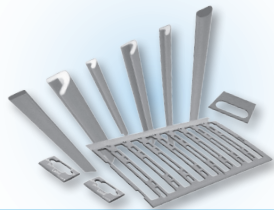

	Fabric-Over-Foam and Conductive Foam	Wire Mesh	Tape
<b>Applications</b>	<ul style="list-style-type: none"> <li>Shielding or grounding of computer and telecommunication equipment seams and apertures</li> </ul>	<ul style="list-style-type: none"> <li>Covers opened infrequently for servicing (6-12 times per year)</li> <li>Long lasting resiliency is ideal for highly sensitive components in permanent or semi-permanent enclosures</li> <li>Consistent point-to-point contact for high shielding effectiveness over the life of the gasket</li> </ul>	<ul style="list-style-type: none"> <li>Design flexibility provides grounding and shielding solutions for I/O shielding panels, disk drive insulators, ground planes or circuit boards, electromedical devices, keyboard devices</li> <li>Mask-and-peel tape for painted electronic enclosures</li> <li>Cable and wire harness wrapping</li> </ul>
<b>Features and Benefits</b> Product Highlights	<ul style="list-style-type: none"> <li>UL 94VO and HB flame retardant</li> <li>Ideal for applications requiring low pressure force</li> <li>Self-terminating cut-to lengths</li> <li>High conductivity and shielding attenuation</li> <li>Galvanically-compatible with most mating surfaces</li> <li>High abrasion and shear resistance</li> </ul>	<ul style="list-style-type: none"> <li>Most economical gasket for low-cycling applications</li> <li>High shielding effectiveness over broad frequency range</li> <li>Available in wide variety of sizes and shapes</li> <li>Knit construction for long lasting resiliency</li> <li>Versatile mounting options</li> <li>Available with elastomer gasket for moisture and dust sealing</li> </ul>	<ul style="list-style-type: none"> <li>Simple installation</li> <li>Ideally suited for thin or low-profile applications</li> <li>Conductive foil tape with release mask for painted enclosures</li> <li>Tin copper cloth and nickel copper cloth versions provide easy-to-handle alternatives to foils</li> </ul>
<b>Electrical Shielding Effectiveness</b> Transfer Impedance (500 MHz)	>85 dB	90 - 105 dB	—
H-field (200 MHz) Modified Mil 285	30 - 45 dB	55 - 65 dB	—
Plane Wave (2 GHz) Modified Mil 285	90 - 100 dB	80 - 115 dB	85 - 95 dB
Surface Resistivity	<0.07 ohms/square	N/A	Low surface resistivity based on material selection
Volume Resistivity	N/A	0.0004 - 0.114 ohm-cm	N/A
<b>Mechanical</b> Available Size Range	Height: 0.015 - 0.945 (0,038 - 24,0)	Height: 0.062 - 0.500 (1,57 - 12,7)	Width: 0.025 - 2.00 (6,4 - 50,8) Thickness: 0.003 - 0.007 (0,08 - 0,18)
Deflection Operating Range	20 - 75% deflection	20 - 70% deflection	N/A
Compression Force (based on shape selection)	3 - 10 lbs/in. ft. (4,5 - 15,0 Kg/m) @ 20% deflection (dependent on foam selection and shape)	From 6 - 50 lbs/in. ft. (8,8 - 74 Kg/m) round	N/A
Compression Set	<4 - 20% @ 50% deflection	10% @ 20% compression	N/A
Joint Unevenness Accommodation	0.020 - 0.050 (0,51 - 1,27)	0.010 - 0.300 (0,25 - 7,6)	N/A
Compound/Material Availability	Cover: Flame retardant metallized Ni/Cu, Tin/Cu and silver woven or non-woven textile. Core: Flame retardant urethane, TPE	BeCu, Monel, aluminum, tin-plated steel, tin-plated brass, Enviroseal version with neoprene or silicone	Tin-plated copper, copper foil, nickel copper cloth tape
Temperature Range	-40 - 158°F (-40 - 70°C)	Enviroseal -103 - 500°F (-75 - 260°C)	50 - 500°F (10 - 260°C) based on material selection
Available Profiles	Round, rectangular, square "D", "C", "J", "P", "U", clip-on, knife edge	Round, rectangular, square, single-round with fin, double-round with fin	Rolls
Mounting Methods	Groove, PSA, clip-on, dart	Groove, pressure-sensitive adhesive, mechanical fasteners, channel mount	Pressure-sensitive adhesive, conductive or non-conductive
Custom Shapes Available	Cut-to lengths, mitered and spliced corners, kiss-cut, other profiles	Cut-to lengths, mitered corners, flat tape, and EMI washers	Die-cut shapes
<b>Environmental</b> Fluid Seal	N/A	Enviroseal product only: moisture, rain	N/A
Air/Dust	Provides barrier against dust	Enviroseal product only	N/A
Galvanic Compatibility	Compatible with a wide variety of mating surfaces—zinc, aluminum, stainless steel, etc.	Variety of platings to ensure galvanic compatibility with mating surface	Wide variety of materials available to meet galvanic compatibility requirements

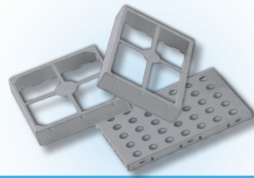
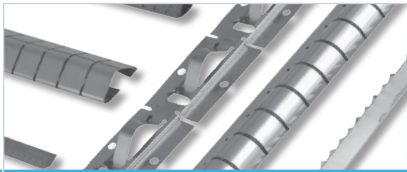

	Fingerstock	Board-Level Shields	Vent Panels and Filters
Applications	<ul style="list-style-type: none"> <li>• Ideal for high-cycling applications requiring frequent access</li> <li>• Ideal in wiping applications when gasket needs to be engaged from either the top or side</li> <li>• Wide variety of profiles and mounting methods accommodating applications from small hand-held devices to room-size enclosures</li> </ul>	<ul style="list-style-type: none"> <li>• All applications that require shielding of board-level components</li> <li>• Low height down to 0.04 (1,0) accommodating mother/daughter board configurations</li> <li>• Secure cover design ideal for applications subject to shock and vibration such as mobile military vehicles, commercial aircraft, and wireless electronics</li> </ul>	<ul style="list-style-type: none"> <li>• Provides air flow for component cooling and a barrier to reduce RF leakage</li> <li>• Sizes range from small muffin fans on desktops to large room-size facilities</li> <li>• Available in commercial and military grade materials</li> </ul>
Features and Benefits Product Highlights	<ul style="list-style-type: none"> <li>• Large selection of sizes and shapes</li> <li>• Wide mechanical operating range</li> <li>• Superior performance at elevated temperatures</li> <li>• High shielding effectiveness levels</li> <li>• Ideal for high-cycle applications</li> <li>• Good design flexibility with either wiping action or in compression</li> <li>• For use in a wide variety of slotted and grounding contact applications</li> </ul>	<ul style="list-style-type: none"> <li>• Custom shapes available</li> <li>• Provides isolation of board-level components</li> <li>• Minimizes crosstalk and susceptibility without impacting system speed</li> <li>• Available in tape-and-reel for automated pick-and-place applications</li> <li>• ReCovr/ReMovl features available for convenient component access.</li> </ul>	<ul style="list-style-type: none"> <li>• Available in a wide range of materials and platings that meet a broad range of shielding effectiveness requirements</li> <li>• Varied mounting configurations meeting environmental space criteria</li> <li>• Available protective grille for high traffic areas</li> <li>• Provides cooling of electronic equipment while maintaining EMI integrity of enclosure</li> <li>• MaxAir vent panels offer 10-20% additional airflow over frames Al vent panels</li> </ul>
<b>Electrical Shielding Effectiveness</b> Transfer Impedance (500 MHz)	80 - 100 dB	—	—
H-field (200 MHz) Modified Mil 285	60 - 70 dB	48 dB	40 - 70 dB
Plane Wave (2 GHz) Modified Mil 285	75 - 120 dB	40 - 60 dB	45 - 115 dB
Surface Resistivity	N/A	N/A	N/A
Volume Resistivity	N/A	N/A	N/A
<b>Mechanical</b> Available Size Range	Selection of various sizes and configurations to accommodate gaps from 0.010 - 0.400 (0,25 - 10,2)	Fence and lid: 0.130 - 1.00 (3,3 - 25,4) height 6.000 (152,4) width One-piece construction: 0.04 - 0.25 (1,0 - 6,4) height, 0.250 - 0.375 (6,35 - 9,53) width	Thickness: 0.25 - 0.500 (6,35 - 12,7)
Deflection Operating Range	20 - 80% deflection, Maximum deflection is dependent on the part profile	N/A	N/A
Compression Force (based on shape selection)	UltraSoft® 98 Series: 1.6 lbs/in. ft. (2,4 Kg/m) to 41 lbs/in. ft. (61 Kg/m) Standard 97 Series: 3.1 lbs/in. ft. (4.6 Kg/m) to 118 lbs/in. ft. (176 Kg/m)	N/A	N/A
Compression Set	None within operating range	N/A	N/A
Joint Unevenness Accommodation	0.003 - 0.350 (0,08 - 8,89) maximum	N/A	N/A
Compound/Material Availability	Standard material is Beryllium Copper, other beryllium free variants on request	Tin-plated phosphor bronze, tin-coated steel, stainless steel, brass, BeCu, and nickel silver; other materials also available	Gasket material: Monel, tin/copper/steel, BeCu, metallized fabric-over-foam Fingerstock frame: aluminum alloy, steel, brass Honeycomb material: aluminum, steel, brass, metallized polymeric
Temperature Range	Continuous operation @ 250°F (121°C)	Withstands reflow and solder temperature	N/A
Available Profiles	Over 350 standard shapes available, as well as cut-to lengths and modified standards that include finger removal, notches, punch holes, etc.	Squares, rectangles, L-shapes, 90° inside corners, and other custom shapes	N/A
Mounting Methods	Clip-on, Sticky Fingers® (pressure-sensitive adhesive tape), rivet, weld, solder, and slot mount	Surface mount/thru-hole, various pin styles available	Captive fastener thru-holes
Custom Shapes Available	Custom designs to meet specific applications	Flexible fence with flat lid, photo etched flat blanks for hand forming, solid can construction, supplied with dividers to provide isolation	Available in circular configurations and custom shapes
<b>Environmental</b> Fluid Seal	None	N/A	Drip-proof versions available
Air/Dust	Limited to twist series with Poron seal	N/A	95% open area for minimal pressure drop
Galvanic Compatibility	Over 20 plating finishes available to ensure galvanic compatibility with mating surface	Compatible with all solder materials	Gasket materials compatible with wide variety of plated surfaces

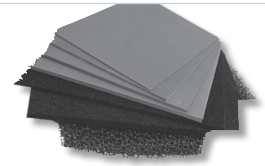
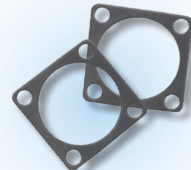
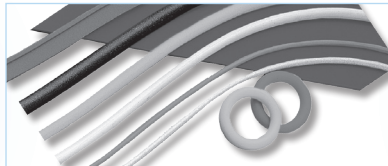
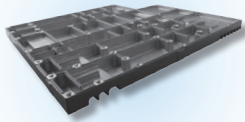







Form-In-Place	Electrically Conductive Elastomers	Oriented Wire	Microwave Absorbers
<ul style="list-style-type: none"> <li>• Ideal for applications with miniature electrical housings, thin wall construction, and intricate multi-components (i.e., cell phones, hand-held devices, medical instrumentation and equipment)</li> </ul>	<ul style="list-style-type: none"> <li>• EMI and environmental sealing applications where flat or groove mounting surface requires a complex molded or extruded shape</li> </ul>	<ul style="list-style-type: none"> <li>• Providing both EMI shielding and an environmental seal on cast or machined surfaces</li> <li>• Vulcanized frame configurations can be used with pre-cast housings, vent panels, and computer terminal window frames</li> <li>• Die-cut wall widths as low as 0.090 (2,27) for circular military connectors and D-sub connectors</li> </ul>	<ul style="list-style-type: none"> <li>• Antenna sidelobe reduction</li> <li>• Surface current suppression</li> <li>• Applied directly to the top of high-speed CPUs, LSIs, and ICs</li> <li>• Crosstalk suppression</li> <li>• Improves antenna gain in RFID applications</li> <li>• Radar cross-section reduction</li> </ul>
<ul style="list-style-type: none"> <li>• Automated process offers cost savings on raw material, labor and assembly time</li> <li>• Small dimension which provide critical packaging space for board level components</li> <li>• Fast prototyping and turn over to mass production</li> <li>• Various bead size and cross section shape available</li> <li>• Dispense on metal or plastics</li> </ul>	<ul style="list-style-type: none"> <li>• Meets military and commercial standards</li> <li>• Provides EMI and environmental shielding</li> <li>• Extruded shapes ideal for extremely narrow mounting surfaces</li> <li>• Custom die-cut and molding available</li> <li>• Wide variety of material compounds for galvanic compatibility to mounting surfaces</li> <li>• High corrosion-resistant compounds available</li> </ul>	<ul style="list-style-type: none"> <li>• Provides both EMI and moisture seal</li> <li>• Available in sponge or solid silicone with Monel or aluminum wire</li> <li>• Can be die-cut in complex shapes</li> <li>• Monel wire bonded into the silicone provides multiple spring effect with each contact point resulting in low compression set</li> </ul>	<ul style="list-style-type: none"> <li>• Higher frequency use than traditional shielding</li> <li>• Frequency range extended used with other shielding</li> <li>• Variety of types for custom solutions</li> <li>• Easy installation into noisy cavities with pressure-sensitive adhesive</li> <li>• EMI and radar cross-section reduction</li> <li>• Internal EMI and cavity resonance reduction, used in conjunction with board-level shielding</li> </ul>
85 - 120 dB	40 - 105 dB	60 - 100 dB	N/A
50 - 70 dB	30 - 75 dB	25 - 60 dB	N/A
70 - 100 dB	40 - 120 dB	30 - 95 dB	N/A
N/A	N/A	N/A	N/A
0.002 - 0.03 ohm-cm	0.002 - 5 ohm-cm	0.006 ohm-cm	N/A
Height: 0.014 - 0.090 (0,36 - 2,3) Width: 0.020 - 0.125 (0,5 - 3,1)	Sheet: 0.020 (0,51) - 0.125 (3,17) thick O-strip: 0.040 (1,02) - 0.250 (6,35) dia. O-tubing: 0.090 (2,28) O.D. x 0.050 (1,27) I.D. to 0.4371 (11,10) O.D. x 0.250 (6,35) I.D.	Thickness: 0.032 - 0.250 (0,81 - 6,35)	Offered in sheets as a die-cut or kiss-cut component
15 - 20% deflection	Sheet: 10% deflection Solid extrusions: 10 - 25% deflection Hollow extrusions: 20 - 50% deflection	10 - 20% deflection	N/A
1.5 lbs/in. ft. (0,27 Kg/cm) @ 0.222 (0,56) height @ 20% deflection	Sheet: 75 - 100 PSI (516,7 - 689 kPa)	25 - 100 PSI (125 - 689 KPa)	N/A
<20% @ 50% deflection	15 - 50% @ 50% deflection	2 - 5% @ 50 PSI (344,5 KPa)	N/A
0.002 - 0.006 (0,05 - 0,15)	Sheet: 0.005 - 0.010 (0,13 - 0,25) Tubing: 0.005 - 0.300 (0,13 - 7,6)	0.005 - 0.015 (0,13 - 0,38)	N/A
Elastomer silicone fillers: Ag/Al, Ag/Cu, Ag/Ni, Ni/graphite	Compounds that meet MIL-G-83528: Elastomers: silicone, fluorosilicone, EPDM Fillers: Ag, Ag/Cu, Ag/Al, Ag/Ni, Ag/GI, CAR, Ni/graphite. Available in NASA-specified ES75 compounds for outgassing	Elastomer: solid or sponge silicone Wire: Monel, aluminum	Microwave absorbing elastomers (Q-Zorb) are offered in silicone; microwave absorber foam is urethane-based, open-celled foam
-58 - 212°F (-50 - 100°C)	-67 to 302°F (-55 to 150°C)	80 - 500°F (26 - 260°C)	Q-Zorb: -85 - 350°F (-65 - 175°C) RF foam: -85 - 250°F (-65 - 120°C)
"D" shape bead	Solid extrusions: rectangular, round, "D", and U-channel Hollow extrusions: square, round, "D", "P", modified standards, cut-to length sheets	Rectangular, strip, flat sheets; die-cut shapes	Q-Zorb thickness: 0.006 - 0.375 (0,15 - 9,53) RF Foam thickness: 0.125 - 0.250 (3,18 - 6,35)
Directly applied to mounting surface	Groove, pressure-sensitive adhesive, channel clip-on, mechanical fastening	Groove, pressure-sensitive adhesive	Pressure-sensitive adhesive
Infinite variety of patterns and larger custom bead sizes	Large variation on extruded shapes, complex die-cuts, and molded parts	Complex die-cut shapes, bonded or vulcanized	Infinite die-cut shapes and molded parts
Moisture, rain seal	Moisture, rain, jet fuel, and nuclear biological chemical (NBC) UL compounds	Moisture and rain	Moisture, rain, jet fuel, and nuclear biological chemical (NBC) UL compounds
In limited applications	Excellent sealing against air and dust	Provides barrier against dust	Available in limited applications
Available in four compounds to provide galvanic compatibility with most mating materials	21 standard variations	Monel and aluminum wire are compatible with a broad range of mating surfaces	Moisture, rain, jet fuel, and nuclear biological chemical (NBC) UL compounds

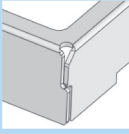

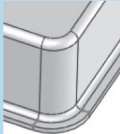

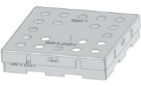
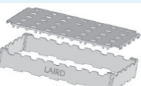
# BOARD LEVEL SHIELDS

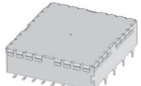
## PRODUCT SELECTION GUIDE

BLS Design Type / Features	Key Attributes & Application Consideration	Corner Feature				
		Traditional Folded	Rigid Corner	Full Drawn w/ Flange	Full Drawn Zero Flange	
						
			Improves Flatness by increasing torsional rigidity	Most mechanically rigid, but depth attainable is material and configuration dependent	Similar to Full Drawn, Tooling more complex.	
<b>SINGLE PIECE</b>						
Single Piece	 Simple low cost BLS Solution	Opt	Std	Opt (height/matl limits)	Opt	
<b>TWO PIECE</b>						
<b>Traditional</b>	 Post Reflow Component Access for inspect, test, cleaning, etc. Various cover retention features available to address rattling, EMI, and shock/vibration concerns. Optional pre-assembled deliverable					
Frame		Opt	Std	Opt (height/matl limits)	Low Height Option	
Cover		Std	Opt	Opt (height/matl limits)	N/A	
<b>ReCovr</b>	 Lower total cost 2 piece solution. Eaveless side wall for maximum component access.	N/A	Req'd	N/A	N/A	
<b>EZ Peel</b>	 Support for legacy products. ReCovr can often be a more reliable alternative. EZ Peel can utilize a separate replacement cover if desired.	Std	N/A	Opt		
<b>97-2000</b>	 Large BLS Applications. Can accommodate internal walls for EMI compartmentation.					
Frame		N/A	N/A	N/A	N/A	
Cover		Std	N/A	N/A	N/A	

### BLS MATERIALS MATRIX

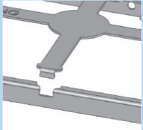
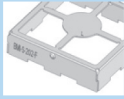
Material Type	Description / Specs	Comments
CRS, Tin Plated	1010 / 1008 CRS	High Permeability Material for low Freq Applications, Very Good Solderability, Mitigation options for Tin Whisker Growth, Pre-plated, Bare stamped edges
Nickel Silver	CA770, CA752	Environmental Performance & Aesthetic Quality, Good Mechanical / Strength Properties, Good Solderability, Active Flux may be required
Stainless Steel	Typical 301 and 316 Series	Environmental Performance, Good option for the cover of 2 piece designs
Copper Alloys	Phosphor Bronze, Beryllium Copper, Brass	Can be chosen for unique requirements that integrate spring contacts, Typically Plated for Solderability and/or corrosion resistance

Unique Product Features	Mounting Features			Size & Shape					
	ReMovl Pick & Place Bridge	SMT Castellations	Thru Hole Loc Pins	Pins, Tabs, Etc.	Interior Walls	Typical Material Thickness	Low Height (less than 2 mm)	Typical Length & Width	Flatness (Size Dep)
 Easy removal of pick and place bridge for post reflow inspection									
N/A	Std	Opt	Opt	No	0.2	Yes	10- 75 mm	0.08	
Opt	Std	Opt	Opt	Opt	0.2	Yes	10- 75 mm	0.08	
N/A	N/A	N/A	N/A	N/A	0.15	Yes	10- 75 mm	0.15	
N/A	Std	N/A	Opt	No	0.3	No	10-40 mm	0.1	
N/A	Std	N/A	Opt	No	0.12	Yes	10-30 mm	0.1	
N/A	Std	Opt	Opt	Opt	0.4	No	50-300 mm	0.2	
N/A	N/A	N/A	N/A	0.25	0.25	No	50-300 mm	0.2	

Cost Position	Applications
Best	Most common BLS solutions
Good	Hi Performance BLS solutions (Mechanical & Environmental)
Better	BLS Covers, Specialty Military
Good	Specialty BLS applications Integrated Spring Contacts

# BOARD LEVEL SHIELDS

Whether it's a one-piece shield, multi-compartmental shield or precision contact, each solution Laird delivers is designed to provide maximum performance within a minimum timeline. Laird produces metal electronic components for surface mount applications in a variety of industries. Laird expertise in a number of key areas ensures that the part provided not only performs, but also optimizes applications. After determining the right board level shield or contact design for an application, Laird experts use the latest systems to develop part designs in just hours.

Laird experienced engineers and technical specialists look beyond the component to the total application.

They work with you to engineer the ideal finished product at the best value.

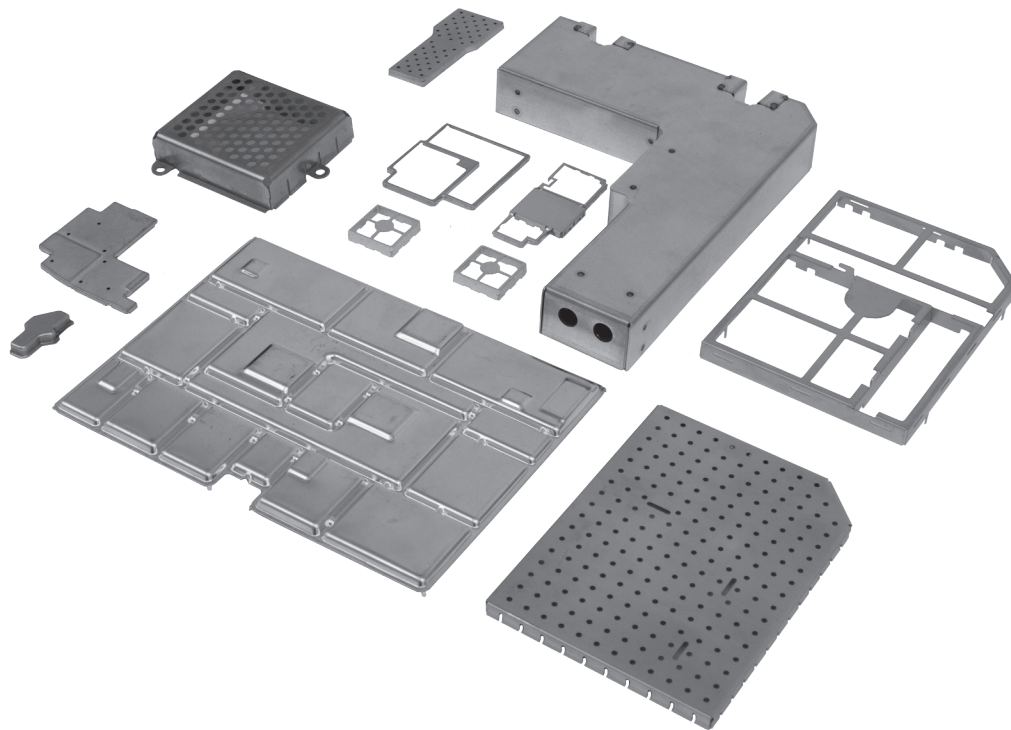

# BOARD LEVEL SHIELDS

## STANDARD DESIGN SHIELDS

### STANDARD SURFACE MOUNT SHIELDS —

#### ONE-PIECE

#### Off the Shelf, On Spec and On Budget

Standard surface mount shields are available in both one-piece and two-piece designs. One-piece shields offer six sides of protection, with the sixth side being the board itself. One-piece designs offer economical shielding protection where access to covered components is not necessary. There are no tooling costs associated with either the one and/or two-piece standard design.

### TYPICAL PROPERTIES AND PERFORMANCE

#### ALL PART NUMBERS

PROPERTY	TEST METHOD	RESULT
Co-planarity	LTWI-1119	< 0.10 mm
Solderability	ANSI/JSTD-002	>99%
Solderability	MIL-STD-202 Method 208	>99%
Surface mount solderability	ANSI/EIA 638	Passes
Appearance	LTIES-125	Passes
Adhesion	ASTM B-571	Passes
3 Axis mechanical shock	LTES-461	Passes

#### Features and Benefits:

- Available in both one-piece and two-piece designs
- One-piece designs offer economical shielding protection
- No tooling costs associated with one or two-piece standard designs

### STANDARD ONE-PIECE BOARD LEVEL SHIELDS

PART NUMBER	MAXIMUM OVERALL LENGTH in (mm)	MAXIMUM OVERALL WIDTH in (mm)	MAXIMUM OVERALL HEIGHT in (mm)	PARTS PER REEL
BMI-S-101	.538 (13,66)	.476 (12,10)	.100 (2,54)	1000
BMI-S-102	.650 (16,50)	.650 (16,50)	.142 (3,60)	700
BMI-S-103	1.032 (26,21)	1.032 (26,21)	.200 (5,08)	300
BMI-S-104	1.260 (32,00)	1.260 (32,00)	.236 (6,00)	225
BMI-S-105	1.500 (38,10)	1.000 (25,40)	.236 (6,00)	250
BMI-S-106	1.450 (36,83)	1.326 (33,68)	.200 (5,08)	300
BMI-S-107	1.747 (44,37)	1.747 (44,37)	.384 (9,75)	120
BMI-S-111	1.032 (26,21)	1.032 (26,21)	.079 (2,00)	625

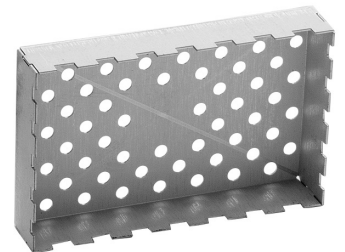
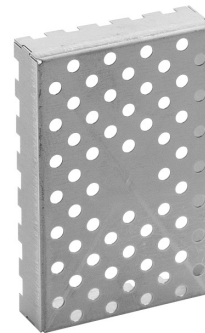

# BOARD LEVEL SHIELDS

## STANDARD DESIGN SHIELDS

### STANDARD SURFACE MOUNT SHIELDS — TWO-PIECE

#### Reduce Board Damage From Inspection and Repairs

Two-piece board level shields offer users the flexibility to inspect or repair shielded components without having to risk board damage by removing the entire shield or incur any tooling costs. Covers snap on and off with ease, which makes repair of the component under the shield quicker and easier and reduces board re-work. Two-piece shields are available unassembled\*, and are designed to survive drop, shock and no-rattle tests.

\*Pre-assembly is an option. Consult sales

### STANDARD TWO-PIECE BOARD LEVEL SHIELDS

PART NUMBER	OVERALL LENGTH in (mm)	OVERALL WIDTH in (mm)	OVERALL HEIGHT in (mm)	PARTS PER REEL
BMI-S-201-F	.538 (13,66)	.476 (12,10)	.100 (2,54)	1000
BMI-S-202-F	.650 (16,50)	.650 (16,50)	.142 (3,60)	700
BMI-S-203-F	1.032 (26,21)	1.032 (26,21)	.200 (5,08)	300
BMI-S-204-F	1.260 (32,00)	1.260 (32,00)	.236 (6,00)	225
BMI-S-205-F	1.500 (38,10)	1.000 (25,40)	.236 (6,00)	250
BMI-S-206-F	1.450 (36,83)	1.326 (33,68)	.200 (5,08)	300
BMI-S-207-F	1.747 (44,37)	1.747 (44,37)	.384 (9,75)	120
BMI-S-209-F	1.156 (29,36)	0.728 (18,50)	.275 (7,00)	400
BMI-S-210-F	1.732 (44,02)	1.201 (30,50)	.118 (3,00)	370
BMI-S-230-F	1.500 (38,10)	2.000 (50,80)	.200 (5,08)	250
BMI-S-230-F-R	1.500 (38,10)	2.000 (50,80)	.200 (5,08)	250
BMI-S-305	1.500 (38,10)	1.000 (25,40)	.236 (6,00)	250

#### Features and Benefits:

- Offers flexibility to inspect or repair shield components without risking board damage
- Covers snap on and off with ease

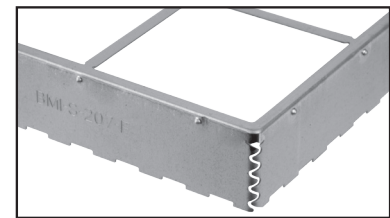
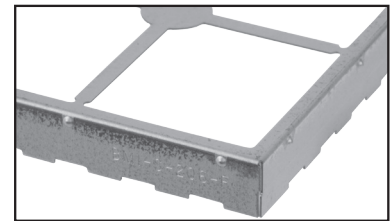

### DESIGN PARAMETERS – ALL PART NUMBERS

PICK-UP SPOT DIAMETER MATERIAL	MATERIAL	THICKNESS CARRIER TAPE	MATERIAL
6 mm or greater 0,20 mm	CRS Tin, Nickel Silver, 300 Series SS	0,20 mm	LTIMS-LCB
COVER TAPE	MATERIAL	REEL	DIAMETER
LTIMS-PSA	330 mm (101, 102, 103, 104, 201, 202, 203, 204) 381 mm (105, 106, 107, 205, 206, 207)	Plastic	EIA-481

# BOARD LEVEL SHIELDS

## EZ PEEL™

### PATENTED SHIELDS ARE SCORED TO ALLOW PEEL-OFF WHEN ACCESS IS NEEDED

These patented shields have a solid top, scored to allow peel-off when access to board level components within the shield is required.

The peel-off feature prevents damage to the board and components by eliminating the need for labor intensive de-soldering, which can often result in increased scrap. Peeling off the cover is accomplished by using a small starter hole for simple removal. This hand operation requires minimal force using a hook scribe or tweezers.

After repair, replacement or adjustment of internal components, the shield can be resealed using a replacement cover. Laird offers two replacement cover options: a snap-in cover and a dish cover.

The snap-in cover utilizes a lance and hole design. The replacement cover snaps into place and locks into a lance feature on the frame of the original shield.

The other option is a dish cover that gets soldered into place on the board. The dish shape allows for self-location of the cover for soldering.

EZ Peel board level shields can be packaged in tape and reel formats for easy SMT installation using conventional pick-and-place equipment. The four standard sizes are also available without the EZ Peel (scored) feature.

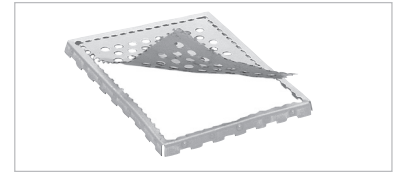

### Features and Benefits:

- Easy removal of scored cover area
- Only requires 1.5 lbs force for cover removal
- Simple replacement technique for cover
- Use on surface mount or through-hole applications
- Shield retains all physical properties after PCMCIA/JEIDA testing for shock, bending, torque, drop and vibration
- CRS 1008/1010 (tin plated) for solderability

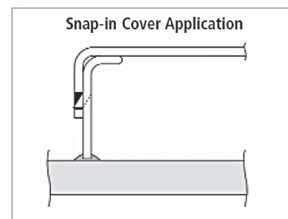
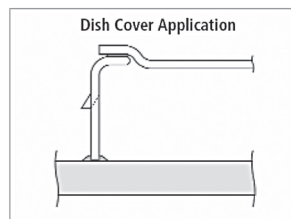
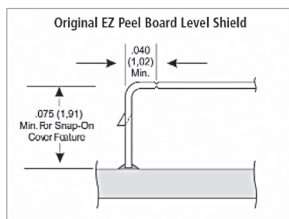

## RIGID CORNER

The rigid corner board-level shield incorporates a corner design that optimizes component rigidity for increased part and printed circuit board (PCB) firmness. As PCB designers are increasingly using thinner substrates, a rigid frame reinforces the assembly, thereby improving overall ruggedness and performance. The shield has improved solder joint reliability and resistance to solder joint fracture, especially in drop testing performance with thin PCBs. Several standard Laird EMI style parts including single-piece, two-piece, and multi-compartmental board-level shields use this new rigid corner design, along with availability in custom sizes as well.

The rigid corner shield is stronger and more robust than traditional formed shields, which results in coplanarity improvement of the solder castellations. The shield can tolerate more deflection (i.e., more handling) without plastic deformation. Elimination of drawn flange reduces the space needed on the PCB for shielding trace width by potentially ~0.3 mm, allowing for the shield to be more closely placed on the PCB. Elimination of draft allows for more undershield space and improved component clearance.

The partially drawn corner is located near the top portion the shield, resulting in improved torsional rigidity with no drawn lip and no draft. For parts over 2 mm, the corner is both drawn and formed with an interlocking multi-radius corner, which provides superior EMI shielding effectiveness. The interlocking corner can be meshed and closed in during the forming and drawing process for additional improved rigidity for parts taller than 2 mm. For parts under 2 mm, the entire corner is drawn without an interlocking corner.

### FEATURES

- Corner openings are reduced, improving shielding performance
- Partially drawn corner located near the top portion of the corner combined with 90° straight forming of wall sections for improved torsional rigidity.
- U.S. Patent No. 7,488,902

### MARKETS

- Computing
- Telecommunications
- Data Transfer and Information Technology
- Automotive
- Consumer Electronics
- Aerospace / Defense
- Medical
- Portability
- Industrial & Instrumentation
- Public Utilities

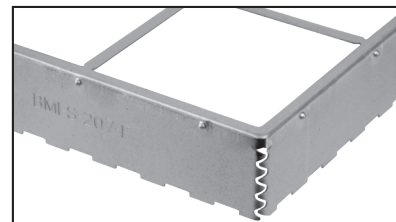

# BOARD LEVEL SHIELDS

## RECOVR™

The proprietary and patented ReCovr™ product line incorporates the functionality of a two-piece shield without the need for a separate frame and cover. The shield is specially designed with a locking mechanism that allows for easy removal of the shield cover when access to board-level components is required. The locking mechanism makes repair of components under the shield quick and easy by eliminating the need for removing the entire shield and reducing board re-work. The removable top shield also integrates Laird patented rigid corner board-level shield technology, which incorporates a new corner design that optimizes component rigidity for increased part and printed circuit board (PCB) firmness.

### FEATURES

- Single-piece board-level shield with a removable top cover
- Eave-less side walls when the cover is removed
- SMT or through-hole pin configurations available
- U.S. Patent No. 7504592
- Other characteristics typical to one-piece shields: vent hole patterns, castellations, trace clearance notches, etc.

### BENEFITS

- Eliminates need for replacement covers
- Offered as an assembled product only: tape and reel, tray pack, or layer pack
- Excellent for periodic testing or rework applications.
- Limited footprint configurations (L-shapes, etc)
- Available in select Laird standard board-level sizes or custom configurations

### MARKETS OR APPLICATIONS

- Computing
- Telecommunications / Datacom
- Automotive
- Consumer Electronics
- SMART Metering
- Aerospace / Defense
- Medical
- Industrial & Instrumentation

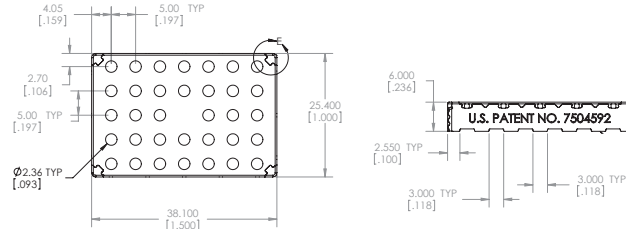
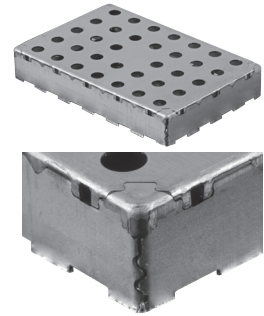

## REMOVL™

The ReMovl feature incorporates the ReCovr attachment mechanism applied to the pickup bridge of a BLS frame to allow for easy, tool less detachment of the bridge after the frame is soldered to the PCB. Ease of detachment along with reliable and consistent separation force will allow for automated detachment.

### FEATURES

- Detachment is permanent – cannot be replaced like ReCovr
- Min Height: 2.0 mm (.080") Lower heights required Product Development Review
- Top Flange Width: 1.8 mm (.071")
- Flatness: Part Size Dependent, but typical to other Frame BLS parts
- Configurations Min 4 legs/branches required (see BLS Style options)
- Limitations: Must be folded or rigid corner type BLS. (No fully drawn parts.)
- Pull Force (Typ) 0.5 – 1.0 lbs

### MARKETS

- Ideal for customer manufacturing processes where post reflow detachment of the pickup bridge is required or desired. Applications that often require the bridge to be detached include:
  - Inspection
  - Rework
  - TIM Assembly into cover
  - Cover with contact fingers to chip, etc.
  - Noise / Vibration concerns of bridge to cover

**Note:** Due to delicate nature of the attachment of the pickup bridge, there will be some risk to the bridge separating during pick and place operations depending on customer manufacturing processes. Pick and place head depth tolerance (z axis) -.020"



# BOARD LEVEL SHIELDS

## INTRODUCTION

The complexities of today's electronics pose several design challenges. Resolving EMI needs to be balanced with space, weight and production restraints. When designing a custom shielding solution, beginning in the earliest stages of the application design allows effective elimination of EMI while meeting all specifications.

Laird board level shielding experts work through all phases of development. From design, rapid prototyping and pre-production through production and automated packaging, Laird has the experience to help speed a product to market and stay within budget.

To increase manufacturing throughout and reduce costs, Laird has developed a proprietary in-line production process that includes part formation, wash, assembly, inspection and automated packaging.

By integrating quality processes, board level shield quality and performance is ensured from design stage through final packaging. One process is the automated co-planarity inspection system. Laird replicates the customer application by measuring shields in the same plane as the printed circuit board. This is accomplished without "securing" or "touching" shields, which could throw off measurement and/or deform parts. Laird measures shields immediately prior to placement into carrier tape at speeds that match automation packing. Shield base materials include our exclusive Shield-Lite™, CRS 1008/1010, beryllium copper alloys, nickel-silver alloys, copper-based alloys and spring steels. All shields are fully solderable.

## ONE-PIECE SHIELD DESIGN LOW COST/EXCELLENT EFFECTIVENESS

Custom surface mount shields are available in both one-piece and two-piece designs. One-piece shields provide six sides of protection, with the sixth side being the board itself. One-piece designs offer economical shielding alternatives where access to covered components for repair is not necessary.

## TWO-PIECE SHIELD DESIGN QUICK, EASY REPAIR AND INSPECTION OF COVERED COMPONENTS

Two-piece board level shields offer users the flexibility to inspect or repair shielded components without having to risk board damage by removing the entire shield. Covers snap on and off with ease, making repairs quicker and easier, and reducing board re-work. Two-piece shields are available pre-assembled or unassembled. Large locking dimples snap into slots on covers to provide mechanical retention force. Smaller grounding dimples provide electrical grounding for proper shielding and to prevent rattle. Two-piece shields survive drop, shock and no-rattle tests. Here are critical test results:

- Able to withstand acceleration of 4g from 10 Hz to 2000 Hz for three hours in each of three planes as per SAE J1455
- Pass EN 50 155 for railway electrical equipment including vibration test of 30g from 5 Hz to 200 Hz in 3 directions and a shock test with 500 m/s for 11/ms
- Pass standard telecommunications drop tests [6 faces, dropped 1 meter onto concrete floor]

Notice: The data set forth in all text, tables, charts, graphs and figures herein are based on samples tested and are not guaranteed for all samples or applications. Such data are intended as guides and do not reflect product specification for any specific part. Material properties are for reference only. Product testing by purchaser is recommended to confirm. Laird assumes no liability for product failure unless specifically stated in writing.

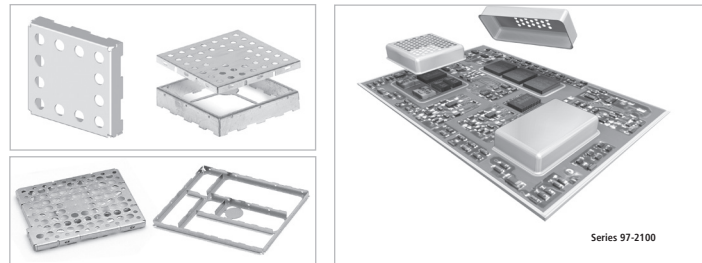

## MULTI-COMPARTMENTAL SHIELD DESIGN SHIELD MULTIPLE CIRCUIT GROUPS SAVE PCB SPACE AND PRODUCTION TIME

Multi-compartmental shields feature internal dividing walls of one material thickness and meet all on-board shield requirements for FCC, VDE, CISPR and CE. These shields are available in two-piece designs, either assembled or unassembled. Our unassembled versions allow for automatic optical inspection prior to cover placement. As in all our shielding offerings, Laird proprietary process for 100% automatic optical inspection verifies co-planarity including inner walls.

## DRAWN BOARD LEVEL SHIELDS SEAMLESS CORNERS ADDRESS HIGH-FREQUENCY LEAKAGE

As microprocessor speeds continue to increase, so does the potential for EMI leakage through the smallest apertures in board level shields. Laird drawn board level shields are designed to provide additional near-field and far-field circuit isolation (attenuation) at higher frequencies by eliminating the apertures found in the corners of traditional board level solutions. Drawn board level shields utilize small ground trace sizes, thereby preserving space on the circuit board.

- Solid corner designs when additional circuit isolation (attenuation) is required at higher frequencies
- Available in custom heights up to .250" (6,4 mm) with length and width dimensions from .300" (7,6 mm) to 2.0" (50,8 mm)
- Tape and reel packaging provides an economical and automated SMT attachment method
- Available in cold rolled steel, brass, stainless steel and nickel silver
- Molded Compartment Shields and Form-In-Place elastomers can be combined with drawn board level shields to achieve shielding of multiple components with a single part
- Available with an EZ Peel scored cover feature; allows for easy top section removal for component repair and re-sealing
- Ventilation holes as needed for solder outgassing.
- Online shielding effectiveness calculator

## SURFACE MOUNT SHIELDS MATERIAL VARIATIONS

RAW MATERIAL*	THICKNESS in (mm)	COMMENTS
Cold Rolled Steel 1008/1010	0.005 to 0.090 (0,127 to 2,286)	Pre-plated Tin
Nickel-silver alloys	0.004 to 0.016 (0,102 to 0,406)	No plating required for SMT solderability
Phosphor Bronze alloys	0.004 to 0.020 (0,100 to 0,510)	Pre-tempered & Preplated

\*Other materials may be available, please consult sales.

Note: Co-planarity dependant on design



# FINGERSTOCK

## PRODUCT SELECTION GUIDE

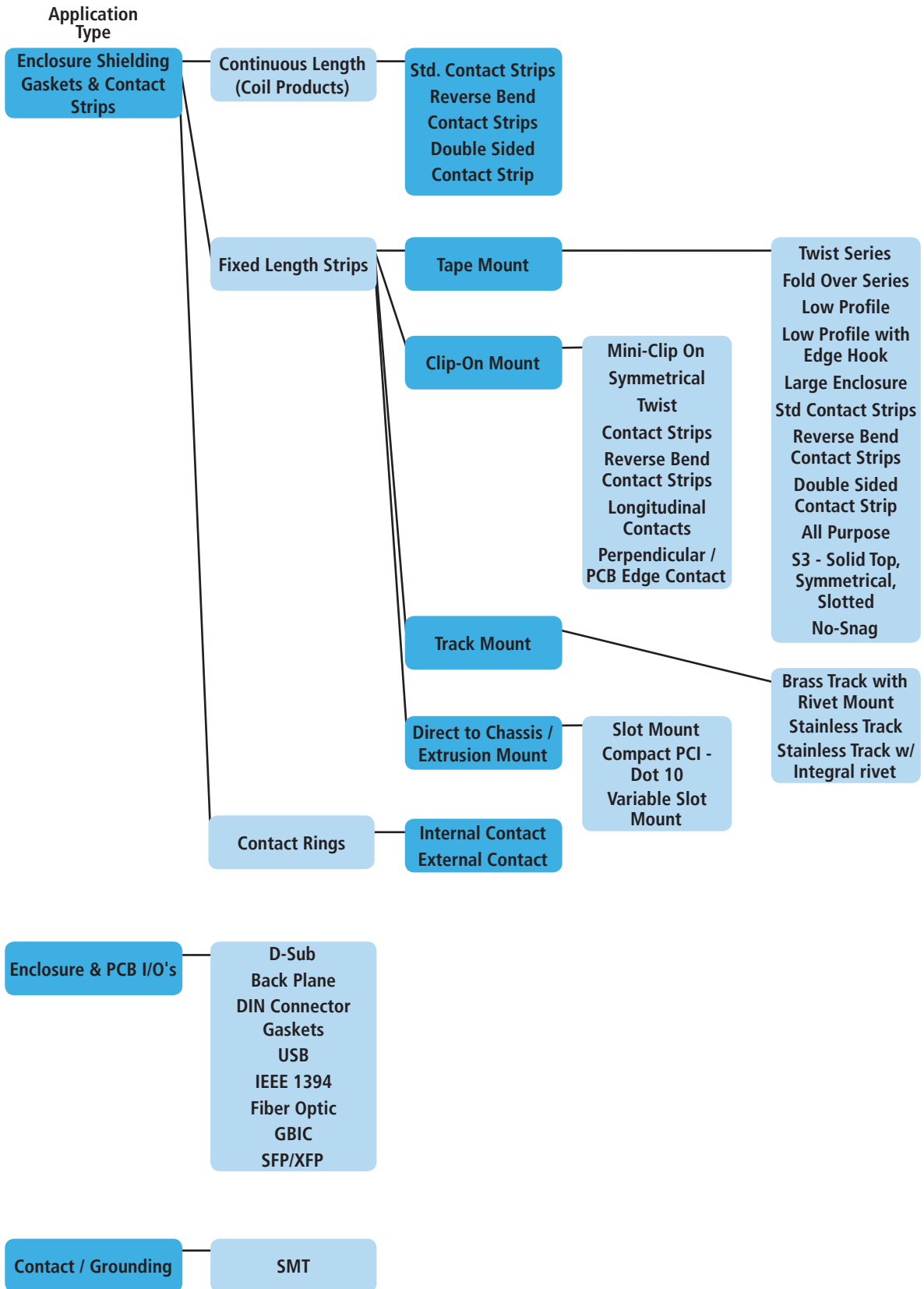

# FINGERSTOCK

Engineered metal Fingerstock solutions from Laird dates from 1938. Laird specializes in designing miniature parts of thin strip metal in quantities ranging from thousands of pieces to millions of pieces. With over 3,400 standard parts, Laird probably already has an off-the-shelf solution that meets your application's requirements.

When custom designs are needed, Laird engineering staff helps construct efficiencies in performance, cost and manufacturability from the very beginning stages of the application.

Laird specialized capabilities:

- Assembly • Heat staking (both hand and automatic)
- Heat treating • In-house die and fixture manufacturing
- Multislid equipment • Photoetching
- Plating • Progressive die stamping
- Prototype fabrication • Resistance welding
- Riveting • Secondary fabrication
- Wire EDM

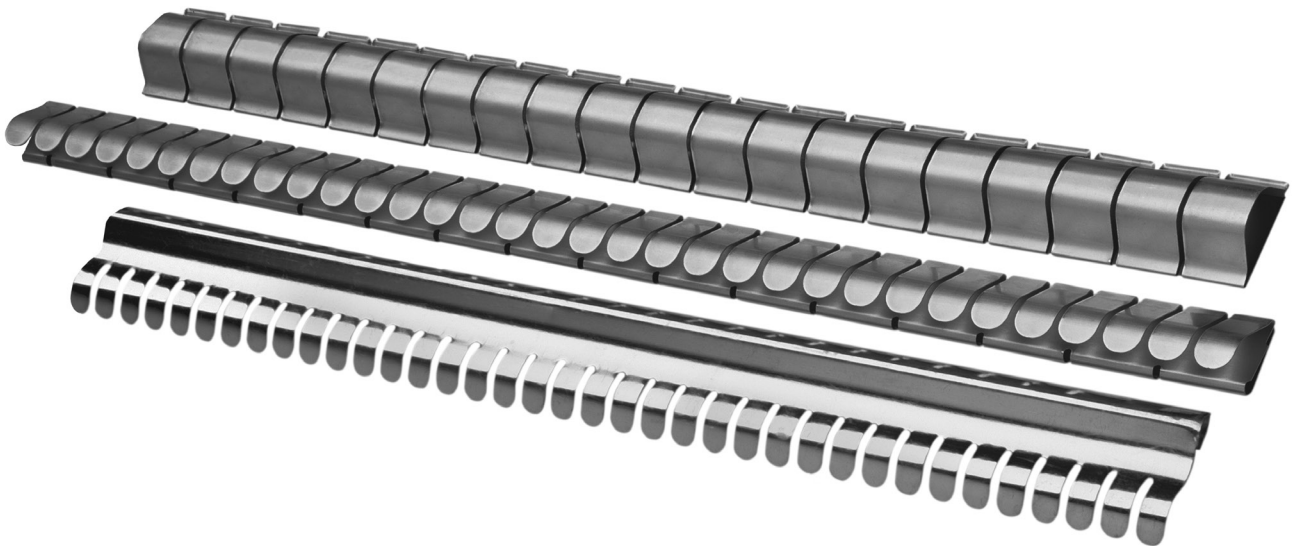

# FINGERSTOCK MOUNTING METHODS

## UNIVERSAL MOUNTING

A stainless steel mounting track is available for use with our full line of gasketing materials. Its unique design offers a secure mounting option versatile enough for use with fingerstock, ElectroNit<sup>®</sup> mesh, ElectroSeal elastomers, UltraSoft<sup>®</sup> Knit and fabric-over-foam products.

PART NUMBER	WIDTH
0095-X996-00	0.310 (7.874)
0095-X997-00	0.430 (10.922)
0095-X998-00	0.600 (15.240)

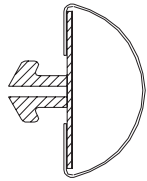

Universal Mount

MATERIAL THICKNESS
A = 0.030 (0.762)
B = 0.045 (1.143)
C = 0.060 (1.524)
D = 0.090 (2.286)
E = 0.150 (3.810)

To identify proper mounting track, select width and corresponding part number from the above chart. Replace the "X" with required material thickness.

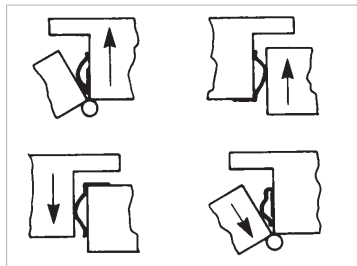
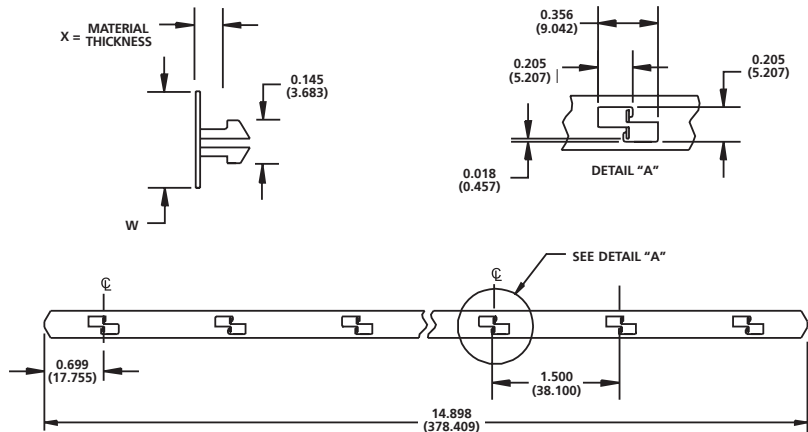

^ Shielding gaskets may be mounted for either wiping or compression closing applications. Proper positioning of the shielding gasket must take into consideration the closing design and the configuration of the mounting surface.

Laird shielding devices may be mounted quickly and easily using any of several different methods. Each installation method is described in the text that follows. However, if you should run into a unique situation not resolved by any of these methods, give us a call. More than likely we can provide the exact answer you need.

### RIVET MOUNT

Riveting produces a tight, long-lasting installation. Either plastic or metal rivets may be used.

### SLOT MOUNT

Slot mounted parts are easily installed using slots where bi-directional movement is required. Simply install part into one slot and snap it into the second slot or over the edge of the frame.

### ADHESIVE MOUNTING

Sticky Fingers<sup>®</sup> is an instant, pressure-sensitive adhesive bonding system, ideal for all-purpose contact strips for metal cabinets and electronic enclosures, and is unaffected by temperatures from -67 to +250°F (-55 to +121°C).

Simply follow these four easy steps:

1. Remove all grease and oily residue with solvent. Smooth the mounting surface with emery cloth.
2. Peel off protective paper backing.
3. Place gasket in correct position. (See mounting methods diagrams A through E.) Press firmly to ensure a good adhesive bond. Avoid repositioning, which might impair the effectiveness of the adhesive or may bend or kink the strip.

NOTE: On items where fingers cover the solid portion of the gasket, pressure may be applied by inserting a mandrel in the strip and pressing down. For contact strips with Magnefil<sup>®</sup> insert, simply press down on the fingers.

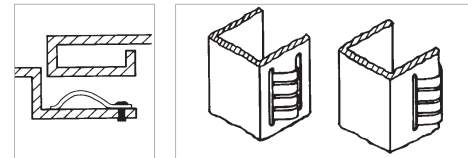

Rivet Mount

Slot Mount

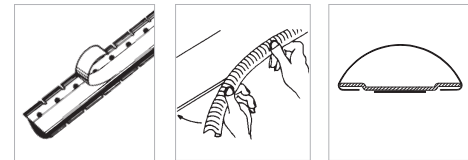

Sticky Fingers<sup>®</sup>

Clip-On Mounting

Tape Track Mounting

4. Allow 24 hours minimum curing time.

Standard parts are supplied with nonconductive tape. For rough surface applications, such as flame-sprayed surfaces, 0.010 in. (0.254 mm) thick nonconductive tape is recommended. Optional conductive tape is also available. Contact a sales department representative for additional ordering information.

### CLIP-ON MOUNTING

Clip-on gaskets hold firmly in place due to their own spring characteristics. Simply push the strips onto the edge or flange of the door or enclosure. Also available are clip-on gaskets with either "T" or "D" lances.

### TAPE TRACK MOUNTING

Stainless Steel mounting track with PSA (pressure sensitive adhesive) is available on the Symmetrical Slotted Series and Slot Mount Series.

### WELDING

Welded mounting requires simple, traditional welding techniques.

### SOLDERING

Solder mounting requires normal low temperature soldering techniques, including cleaning and fluxing of parts with common copper flux materials.

# FINGERSTOCK

## ORDERING INFORMATION

### Part Number Format

Example:  
 Stock Item — Unique Part No. — Finish I.D.  
 0097 — 0520 — 02

- In the above example, Laird part number 0097-0520-02 is a 97-520 RFI/EMI shielding gasket with a bright finish
- When ordering UltraSoft® items, the stock item prefix will be 0098 or 0078. The above example in UltraSoft would be 0098-0520-02.
- When ordering coil, the prefix 0C should precede the stock item number; for example: 0C97, 0C98, 0C77 or 0C78
- When ordering stainless steel items, the stock item prefix will be 0095
- Standard plating finish is 0.0001 in. (0.0025 mm) min. [gold 0.00005 in. (0.0013 mm) min.] but can be varied to meet your custom needs
- Modifications to standard parts are specified by an X (following finish I.D.) for quoting only. Upon ordering, a specific part number will be assigned.
- For tape options, see Adhesive Mounting — Sticky Fingers® on page 16
- Use the catalog number for the unique part number and refer to the following chart for finish I.D.

### Plating Finishes

Finish Designation	Finishes for Fingerstock Products (BeCu and RCC)	Laird ID	Specifications	Specification Details*
Unplated	Bright Finish	02	Laird Designation	Unplated, Bright or Ultrasoft surface
	Solderable Unplated	21	Laird Designation	Solderable bright finish
Gold	Gold	03	ASTM B 488 / SAE AMS 2422	Type I & II, grade C, 1.27 - 2.5 µm thick
	Gold/Nickel Underplate	10	ASTM B 488 / SAE AMS 2403	Type I & II, grade C, 1.27 - 2.5 µm thick
Silver	Silver (matte)	04	ASTM B 700 / QQ-S-305	Type II, grade A, 2.5 - 7.6 µm thick
Cadmium**	Cadmium + Yellow Chromate	05	ASTM B 766 / AMS QQ P 416	Type II, class 5, min 5 µm thick
	Cadmium + Clear Chromate	06	ASTM B 766 / AMS QQ P 416	Type III, class 5, min 5 µm thick
Tin Lead**	Tin Lead [60/40] Solder	07	ASTM B 579 / SAE AMS P 81728	7.6 - 12.7 µm thick
Nickel	Dull Nickel	09	ASTM B 689 / SAE AMS 2403 (QQ-N-290)	2.5 - 7.6 µm thick*
	Bright Nickel	19	ASTM B 689 / SAE AMS 2403 (QQ-N-290)	2.5 - 7.6 µm thick*
	Sulfamate Nickel	24	ASTM B 689 / SAE AMS 2424	2.5 - 7.6 µm thick (1.27 - 2.5 µm underplate)
Electroless Nickel	Electroless Nickel	18	ASTM B 733 / SAE AMS C 26074	2.5 - 7.6 µm thick
Tin	Satin / Matte Tin	08	ASTM B 545 / MIL-T-10727C	Type I, 2.5 - 7.6 µm thick
	Bright Tin	17	ASTM B 545 / MIL-T-10727C	Type I, 2.5 - 7.6 µm thick
Zinc***	Zinc + Yellow Chromate	16	SAE AMS 2402 / ASTM B 633	Type II, 2.5 - 7.6 µm thick
	Zinc + Clear Chromate	15	SAE AMS 2402 / ASTM B 633	Type III, 2.5 - 7.6 µm thick

#### Notes:

- Laird standard plating codes are defined according to the above specifications. Any non-standard requirements (different classes or types within a specification) must be clearly identified on the production prints.
- The plating thickness indicates the thickness measured on the primary out-surface of fingerstock products.

\* Class 1, Grade G in QQ-N-290

\*\* Outsourced process

\*\*\* Laird provides RoHS compliant Trivalent Chromate

# FINGERSTOCK

## ULTRASOFT® SERIES

Series UltraSoft® fingers have been designed for communications, computers and electronic systems designers concerned with EMI compliance and lightweight enclosure designs. Available in the same full range of standard configurations, UltraSoft fingers offer designers greater flexibility and versatility than ever before—permitting more extensive use of lighter, thinner construction materials to help cut costs and/or enhance system performance.

The unique advantages of UltraSoft (98-Series) fingers include:

- The lowest compression forces in the industry
- Shielding effectiveness comparable to similarly configured standard 97-Series parts
- Wide selection of sizes and configurations
- Low compression force version available for virtually every standard shielding product

UltraSoft (98-Series) products are available in the same lengths as the standard (97-Series) products. Please refer to the appropriate standard product pages for specific information. All UltraSoft products are also available in your choice of finishes.

### Shielding Effectiveness Comparison

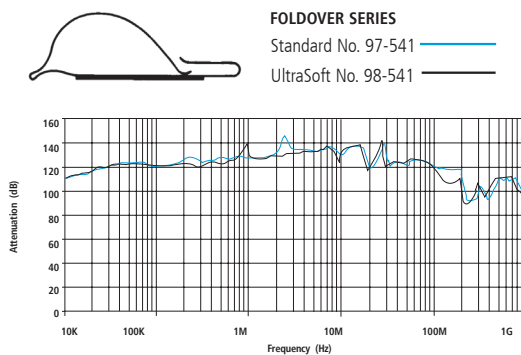

### Compression Force Comparison

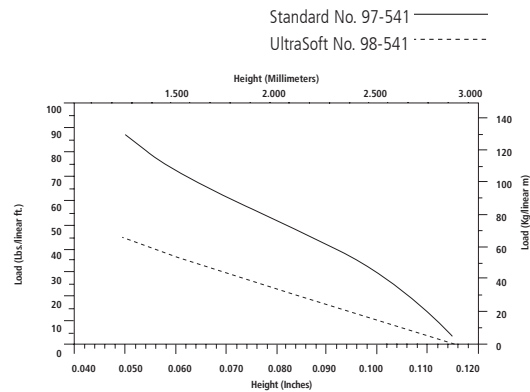

## RECYCLABLE CLEAN COPPER™

Recyclable Clean Copper products meld strong stability and tensile strength with high levels of thermal and electrical conductivity making it suitable for utilization in both grounding and shielding applications at a cost that is comparable with traditional metal EMI shields. Shielding effectiveness is similar to other copper alloys with values over 100 dB shielding effectiveness readily achieved.

Recyclable Clean Copper is fully compliant to EU Directive 2002/95/EC and alleviates the environmental, safety and segregation concerns associated with the traditional use and recycling of beryllium-based copper alloys.

This alternative material exhibits excellent corrosion resistance, platability, solderability and stress relaxation properties.

The product is targeted at high volume designs. Custom stampings are available upon customer request. As with all of Laird metal fingerstock gaskets, Recyclable Clean Copper is completely flameproof.

For mounting methods and other specific product information, please see Laird catalog "Fingerstock, Gaskets and Metal Grounding Products".

To find out more about this exciting new product available from Laird please contact sales for assistance or visit us at [www.lairdtech.com](http://www.lairdtech.com).

Recyclable Clean Copper (RCC) beryllium-free EMI shielding offers customers an excellent alternative to beryllium containing alloys (BeCu) in a wide range of slotted applications. The conversion of part number (Stock Item) of BeCu to RCC:

BeCu	RCC
0077-	0067-
0c77-	0c67-
0097-	0087-
0c97-	0c87-
0078-	0068-
0c78-	0c68-
0098-	0088-
0c98-	0c88-

# FINGERSTOCK SLOT MOUNT SERIES

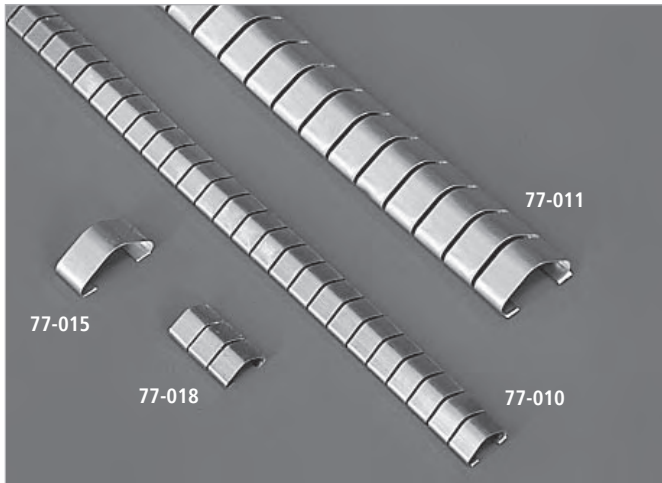

Laird Slot Mount Series of beryllium copper shielding gaskets is designed for use in a wide variety of slotted applications. This economical product line is ideal for both grounding and shielding applications.

- Minimal slot fabrication cost
- Easy and cost-effective installation since fasteners and adhesives are not required
- Bi-directional wiping and compression action to accommodate a wide variety of designs
- Ideal for grounding and shielding in the following electronic enclosure applications:
  - Front panel handles
  - Chassis covers
  - Plug-in units
  - Backplanes
  - Subrack assemblies
- Standard (77-Series) and UltraSoft® (78-Series low compression versions) are also supplied in 25.0 ft. (7.6 m) coils

The Slot Mount Series is available in your choice of finishes, see page 17.

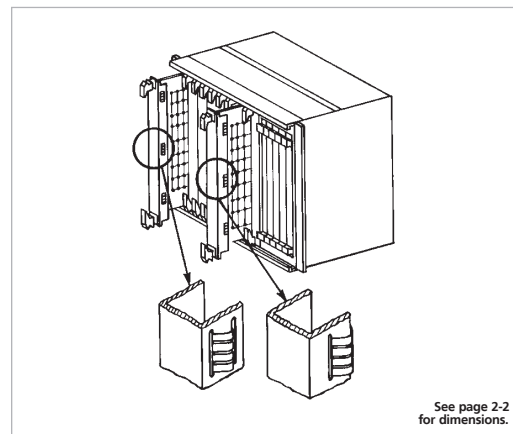
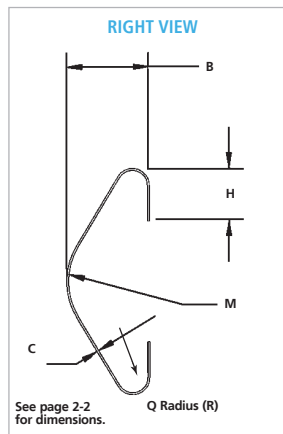
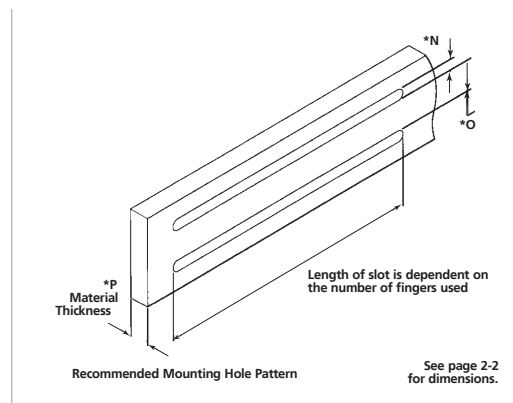
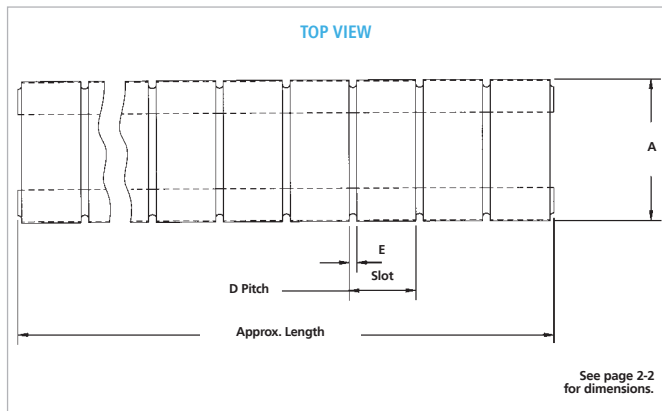

Slot Mount Series are available with Universal and Tape Track mounting options, see page 1-9, 1-10.



# FINGERSTOCK DUAL SLOT SERIES



Part No. 77-075, 77-093, 77-110

Dual slot mount parts are available for a variety of slotted applications. The dual slot feature optimizes the compression force and provides a good operating range. This product is ideal for both shielding and grounding applications. The bi-directional wiping and compression action accommodates a wide variety of designs. Ideal for use in the grounding and shielding of front panel handles, sub rack assemblies, plug-in units, back planes and other electronic enclosure applications.

### DUAL SLOT SERIES DIMENSIONS

SERIES	A	B	C	D	E	H	M	N	O	P	Q	LENGTH # OF		
												APPROX.	FING.	
77-075	0.325 (8.255)	0.100 (2.54)	0.003 (0.076)	0.187 (4.750)	0.018 (0.457)	0.085 (2.159)	0.110 (2.794)	0.090 (2.286)	0.260 (6.604)	0.040 (1.016)	0.020 (0.508)	16.000 (406.400)	86	—
77-093	0.325 (8.255)	0.140 (3.556)	0.003 (0.076)	0.187 (4.750)	0.018 (0.457)	0.085 (2.159)	0.110 (2.794)	0.090 (2.286)	0.260 (6.604)	0.040 (1.016)	0.020 (0.508)	16.000 (406.400)	86	—
77-110	0.325 (8.255)	0.125 (3.175)	0.003 (0.076)	0.187 (4.750)	0.018 (0.457)	0.085 (2.159)	0.110 (2.794)	0.090 (2.286)	0.260 (6.604)	0.040 (1.016)	0.020 (0.508)	16.000 (406.400)	86	—

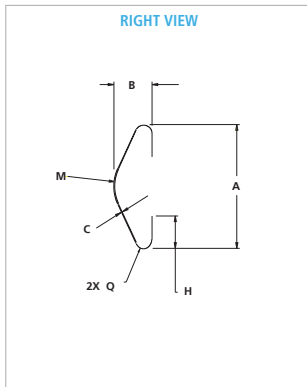
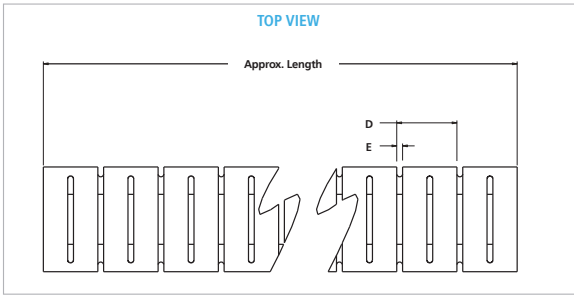

All dimensions shown are in inches (millimeters) unless otherwise specified.

# TEARDROP SERIES

Teardrop slot fingerstock gaskets include a shaped cut developed to optimally distribute the mechanical stresses when the part is compressed, and to avoid excessive insertion forces on a stack of rack mounted modules. Please contact a Laird technical resource to review current applications that might benefit from incorporating this feature into existing gaskets where minimal insertion force is desired. Patent # 7,112,740

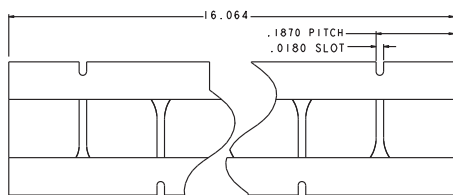

0097-0987

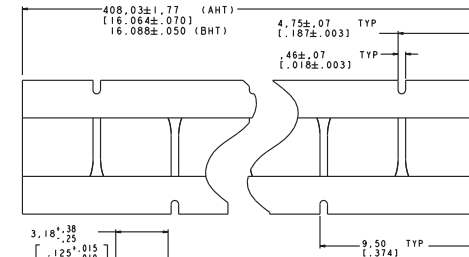
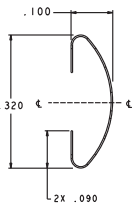

0097-0988



# FINGERSTOCK

## COMPACT PCI SYMMETRICAL MOUNT

Laird offers a unique product designed to shield the front panels of IEEE standard 1101.10 card cages, commonly referred to as Dot-10, called the Compact PCI gasket.

This front panel shielding has been designed to shield between the front panels on sub racks and plug-in units. This is a beryllium copper solid top symmetrical slotted fingerstock strip pre-plated in sulfamate nickel. It is designed to mount on the "T" shape on a front panel extrusion (see below). Specially designed for wiping applications, this configuration allows total symmetrical compression action with bi-directional engagement.

Standard size shown is based on the 9.5" (241.300) length per the Dot-10 standard. Other lengths and plating finishes are available for your specific application.

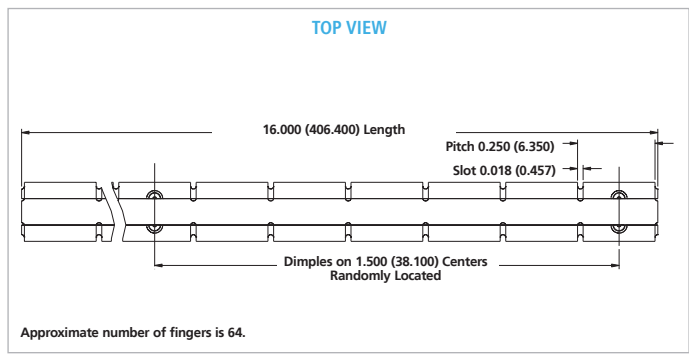
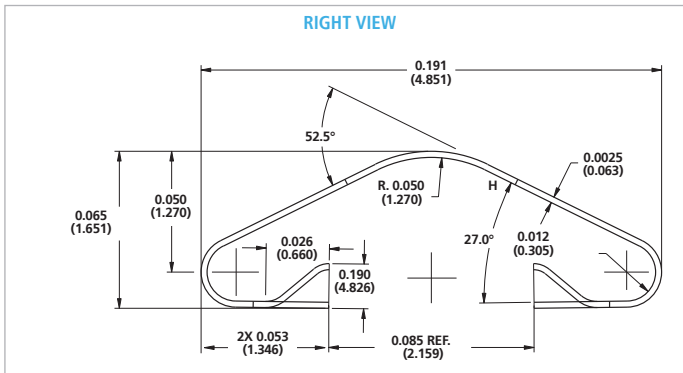
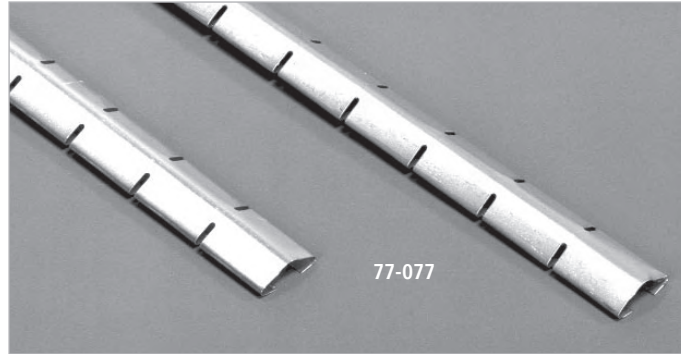

## ALTERNATE SLOT SERIES

Laird alternating slot/cut design is designed for use in a wide variety of slotted applications, such as front panel handles, plug-in units, subrack assemblies, chassis covers and backplanes.

Available in a wide variety of plating finishes to meet galvanic compatibility requirements.

Available in UltraSoft™, low compression series (-078).

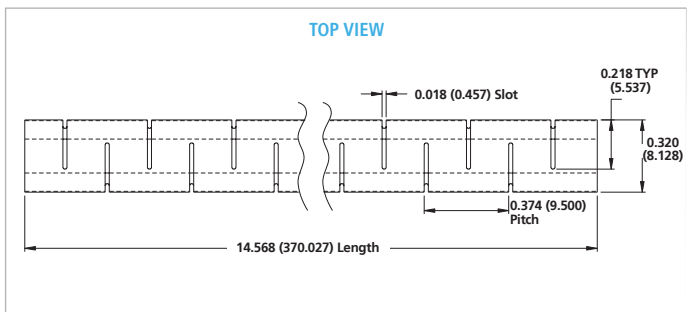
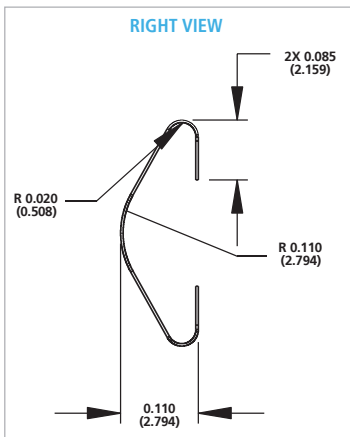
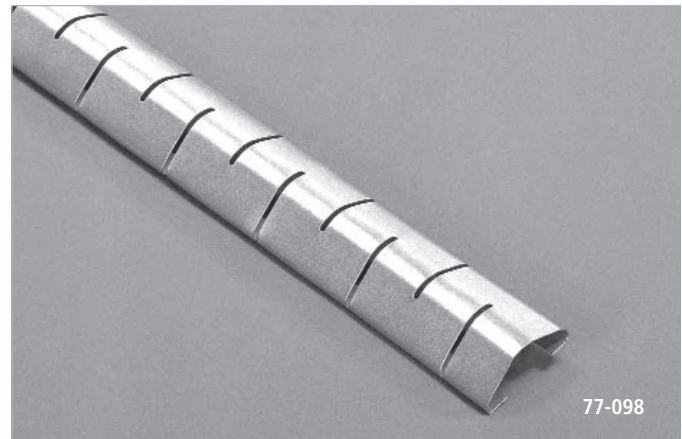

# FINGERSTOCK

## VARIABLE SLOT MOUNT

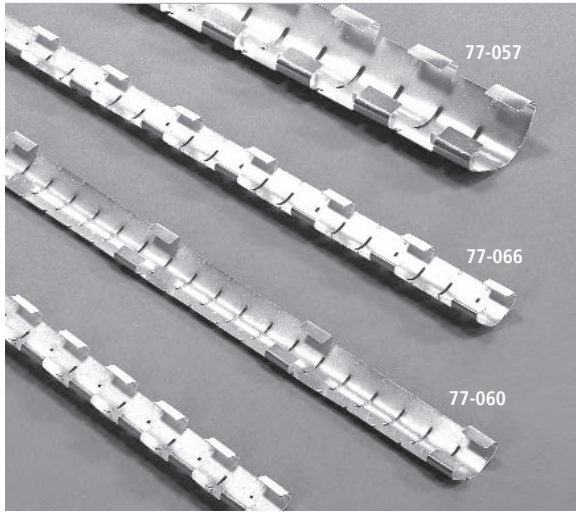

Laird introduces Variable Slot Mount shielding, which eliminates the use of long slots while still utilizing the easy installation method of slot mount shielding. Fingers are removed from the strip in areas where a mounting slot is not present. The Variable Slot Mount shielding strips can be customized to any patterned series of slots.

- Easy and cost-effective installation since fasteners and adhesives are not required
- Improved shielding effectiveness compared to traditional slot mount series through elimination of long slots in host material
- Slot mounting feature can be varied to accommodate different lengths and hole mounting patterns (see figure 2)
- Three and five pitch segments ideal for grounding applications
- Bi-directional wiping and compression action to accommodate a wide variety of designs
- Available in standard (77-Series) and UltraSoft® (78-Series low compression versions)
- Ability to retrofit equipment when higher clock speeds limit current slot mount product without changing slot size or location
- One piece construction eliminates handling individual pieces, thereby shortening installation time
- Ideal for grounding and shielding in the following electronic enclosure applications:
  - Front panel handles
  - Chassis covers
  - Backplanes
  - Plug-in units
  - Subrack assemblies

FIGURE 1: REPEATING FINGER PATTERN

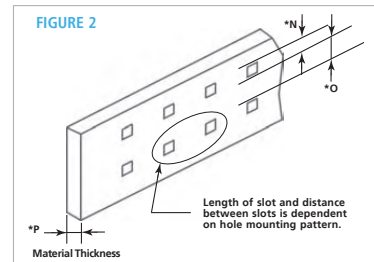
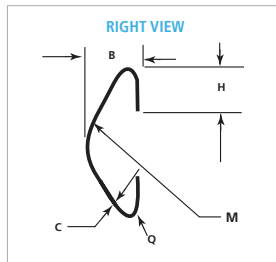
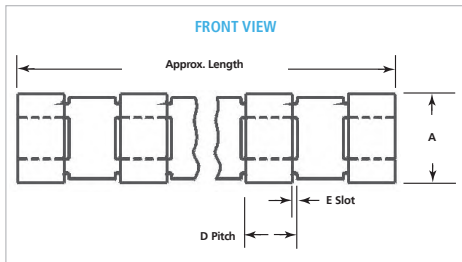
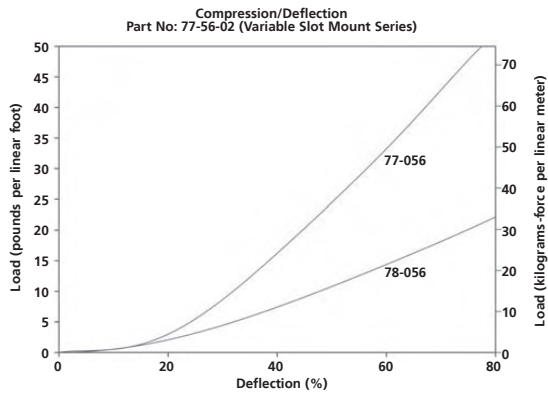
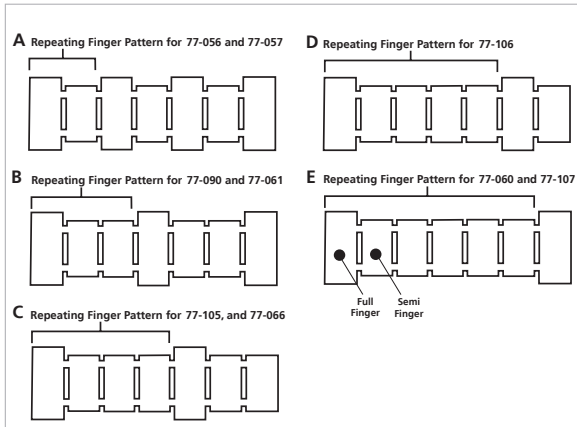

VARIABLE SLOT MOUNT DIMENSIONS

SERIES VIEW**	A	B	C	D	E	H	M	*N	*O	*P	Q (R)	LENGTH APPROX.	# OF FING.
77-056	0.320	0.110	0.004	0.187	0.018	0.085	0.110	0.090	0.260	0.040	0.020	16,000	86
A	(8.128)	(2.794)	(0.102)	(4.750)	(0.457)	(2.159)	(2.794)	(2.286)	(6.604)	(1.016)	(0.508)	(406.400)	—
77-057	0.600	0.220	0.005	0.282	0.032	0.130	0.180	0.140	0.520	0.070	0.040	16,000	57
A	(15.240)	(5.588)	(0.127)	(7.163)	(0.813)	(3.302)	(4.572)	(3.556)	(13.208)	(1.778)	(1.016)	(406.400)	—
77-060	0.320	0.110	0.003	0.187	0.018	0.085	0.110	0.090	0.260	0.040	0.020	16,000	86
A	(8.128)	(2.794)	(0.076)	(4.750)	(0.457)	(2.159)	(2.794)	(2.286)	(6.604)	(1.016)	(0.508)	(406.400)	—
77-061	0.320	0.110	0.003	0.187	0.018	0.085	0.110	0.090	0.260	0.040	0.020	16,000	86
B	(8.128)	(2.794)	(0.076)	(4.750)	(0.457)	(2.159)	(2.794)	(2.286)	(6.604)	(1.016)	(0.508)	(406.400)	—
77-066	0.320	0.110	0.003	0.187	0.018	0.085	0.110	0.090	0.260	0.040	0.020	16,000	86
C	(8.128)	(2.794)	(0.076)	(4.750)	(0.457)	(2.159)	(2.794)	(2.286)	(6.604)	(1.016)	(0.508)	(406.400)	—

SERIES VIEW**	A	B	C	D	E	H	M	*N	*O	*P	Q (R)	LENGTH APPROX.	# OF FING.
77-090	0.600	0.220	0.005	0.282	0.032	0.140	0.180	0.140	0.520	0.070	0.040	16,000	57
B	(15.240)	(5.588)	(0.127)	(7.163)	(0.813)	(3.556)	(4.572)	(3.556)	(13.208)	(1.778)	(1.016)	(406.400)	—
77-105	0.600	0.220	0.005	0.282	0.032	0.140	0.180	0.140	0.520	0.070	0.040	16,000	57
C	(15.240)	(5.588)	(0.127)	(7.163)	(0.813)	(3.556)	(4.572)	(3.556)	(13.208)	(1.778)	(1.016)	(406.400)	—
77-106	0.600	0.220	0.005	0.282	0.032	0.140	0.180	0.140	0.520	0.070	0.040	16,000	57
D	(15.240)	(5.588)	(0.127)	(7.163)	(0.813)	(3.556)	(4.572)	(3.556)	(13.208)	(1.778)	(1.016)	(406.400)	—
77-107	0.600	0.220	0.005	0.282	0.032	0.140	0.180	0.140	0.520	0.070	0.040	16,000	57
E	(15.240)	(5.588)	(0.127)	(7.163)	(0.813)	(3.556)	(4.572)	(3.556)	(13.208)	(1.778)	(1.016)	(406.400)	—

\* May vary depending upon application.  
 \*\* See Figure 1 for finger patterns.

# FINGERSTOCK

## SYMMETRICAL (S<sup>3</sup>) SLOTTED SHIELDING

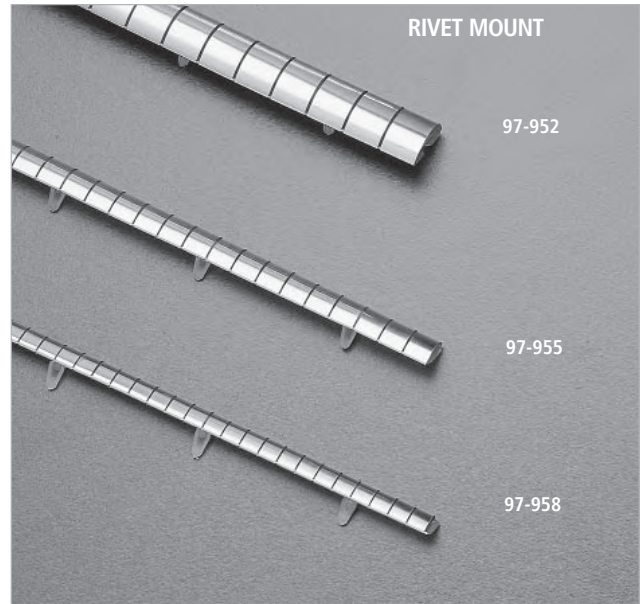
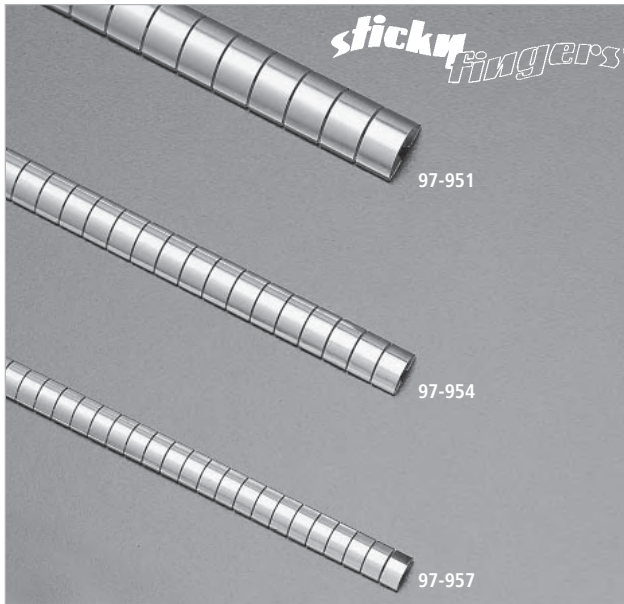

Strips with Sticky Fingers® and Rivet Mounts exhibit typical attenuation >100 dB for a 100 MHz plane wave.

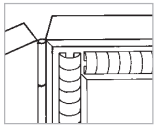

### WITH STICKY FINGERS

Series 97-951/954/957 are low compression, adhesive-mounted beryllium copper shielding strips. Designed as a continuous band, the strip is slotted to permit spring contact throughout its length. A wide radius profile creates

the greatest contact for maximum conductivity with minimum compression requirements. As with all Sticky Fingers shielding strips, a self-adhesive tape makes mounting easy and secure. All are available in your choice of finishes, see page 17.

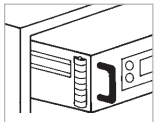

### WITH BI-DIRECTIONAL RIVET MOUNT

Series 97-952/955/958 are as described above, but with the addition of an integral pierced brass track to provide plastic push rivet mounting in a 0.125 in. (3.175 mm) diameter hole.

Designed especially for slide applications, this configuration allows total symmetrical compression action with bi-directional engagement. It is recommended for high temperature and/or extremely high side load situations, such as PC board connections and electronic drawers. All are available in your choice of finishes, see page 17. Both are available in UltraSoft® low compression force 98-Series.

### S<sup>3</sup> SERIES

SERIES	A	B	C	D
95-901	0.284 (7.214)	0.030 (0.762)	0.010 (0.254)	0.068 (1.727)
95-902	0.325 (8.255)	0.030 (0.762)	0.010 (0.254)	0.080 (2.032)

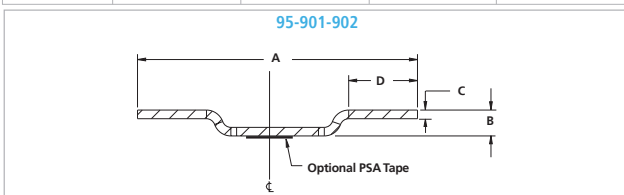

### S<sup>3</sup> SERIES — STICKY FINGERS

SERIES	A MIN.	B	C	D	E	K	L	APPROX. LENGTH
97-951	0.620 (15.748)	0.220 (5.588)	0.004 (0.102)	0.375 (9.525)	0.030 (0.762)	0.760 (19.304)	0.100 (2.540)	15.000 (381.000)
97-954	0.450 (11.430)	0.140 (3.556)	0.003 (0.076)	0.250 (6.350)	0.022 (0.559)	0.510 (12.954)	0.070 (1.778)	15.000 (381.000)
97-957	0.350 (8.890)	0.110 (2.794)	0.003 (0.076)	0.187 (4.750)	0.018 (0.457)	0.380 (9.652)	0.055 (1.397)	15.000 (381.000)

### S<sup>3</sup> SERIES — RIVET MOUNT

SERIES	A	B MIN.	C	D	E	K	L	APPROX. LENGTH	M	N	NO. OF RIVETS
97-952	0.620 (15.748)	0.220 (5.588)	0.004 (0.102)	0.375 (9.525)	0.030 (0.762)	0.760 (19.304)	0.100 (2.540)	15.000 (381.000)	0.560 (14.224)	0.940 (23.876)	10 —
97-955	0.450 (11.430)	0.140 (3.556)	0.003 (0.076)	0.250 (6.350)	0.022 (0.559)	0.510 (12.954)	0.070 (1.778)	15.000 (381.000)	0.630 (16.002)	0.880 (22.352)	10 —
97-958	0.350 (8.890)	0.110 (2.794)	0.003 (0.076)	0.187 (4.750)	0.018 (0.457)	0.380 (9.652)	0.070 (1.778)	15.000 (381.000)	0.660 (16.764)	0.840 (21.336)	10 —

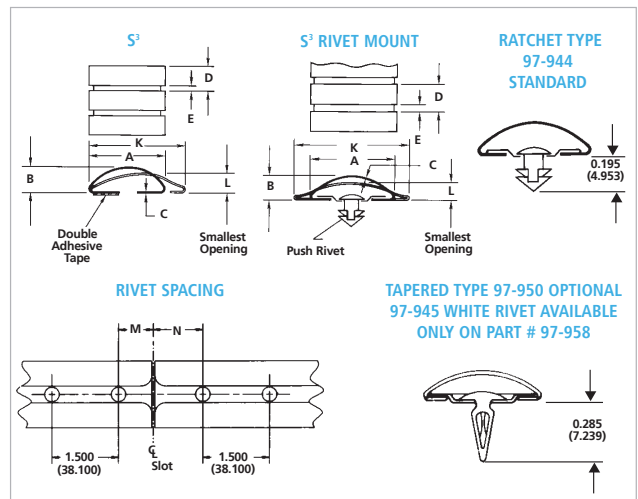

2 rivet types are available. Consult sales for more information.

# FINGERSTOCK SOLID TOP (S<sup>3</sup>) SYMMETRICAL SLOTTED SHIELDING GASKET

Laird offers their Solid Top Symmetrical Slotted Shielding Gaskets. This product is uniquely designed for those applications where a lid or cover is closed using a sliding motion to complete the closure. The solid top design allows the cover to slide either perpendicularly or parallel to the fingerstock without snagging or damaging the gasket.

- Solid top provides an additional 10 dB of shielding effectiveness
- Offered in both rivet mount and tape mount versions
- Available with two types of rivets
- Generous radii provide maximum conductivity with minimum compression forces
- Parts can be modified and/or cut to any specific length
- For longitudinal sliding applications, a retention clip is recommended for secure mounting
- Available in standard or UltraSoft<sup>®</sup> (part numbers beginning with -98) versions

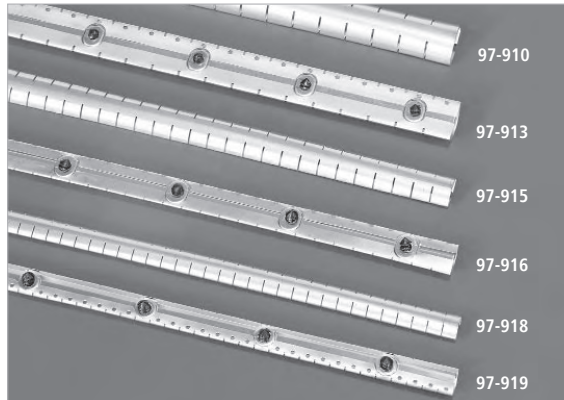

### SOLID TOP S<sup>3</sup> SERIES - STICKY FINGERS

SERIES	A MIN.	B	C	D	E	K	L	APPROX. LENGTH
97-910	0.620 (15.748)	0.220 (5.588)	0.004 (0.102)	0.375 (9.525)	0.030 (0.762)	0.760 (19.304)	0.100 (2.540)	15.000 (381.000)
97-915	0.450 (11.430)	0.140 (3.556)	0.003 (0.076)	0.250 (6.350)	0.022 (0.559)	0.510 (12.954)	0.070 (1.778)	15.000 (381.000)
97-918	0.350 (8.890)	0.110 (2.794)	0.003 (0.076)	0.187 (4.750)	0.018 (0.457)	0.380 (9.652)	0.070 (1.778)	15.000 (381.000)

### SOLID TOP S<sup>3</sup> SERIES - RIVET MOUNT

SERIES	A MIN.	B	C	D	E	K	L	APPROX. LENGTH	M	N	NO. OF RIVETS
97-913	0.620 (15.748)	0.220 (5.588)	0.004 (0.102)	0.375 (9.525)	0.030 (0.762)	0.760 (19.304)	0.100 (2.540)	15.000 (381.000)	0.560 (14.224)	0.940 (23.876)	10 —
97-916	0.450 (11.430)	0.140 (3.556)	0.003 (0.076)	0.250 (6.350)	0.022 (0.559)	0.510 (12.954)	0.070 (1.778)	15.000 (381.000)	0.630 (16.002)	0.880 (22.352)	10 —
97-919	0.350 (8.890)	0.110 (2.794)	0.003 (0.076)	0.187 (4.750)	0.018 (0.457)	0.380 (9.652)	0.070 (1.778)	15.000 (381.000)	0.660 (16.764)	0.840 (21.336)	10

RETENTION CLIP	PART NO.	RIVET MOUNT PART NO.
97-964	Used On	97-919
97-965	Used On	97-916
97-966	Used On	97-913

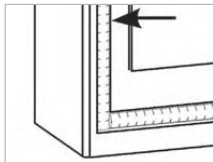

View A - Computer tower side panel is moved sideways during the first step of installation.

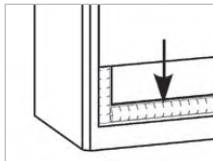

View B - Next, the panel is moved downwards, sliding longitudinally on the vertical finger gasket.

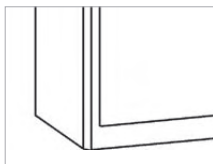

View C - Fully installed panel is now compressing both finger gaskets.

### SOLID TOP S<sup>3</sup> TRANSFER IMPEDANCE

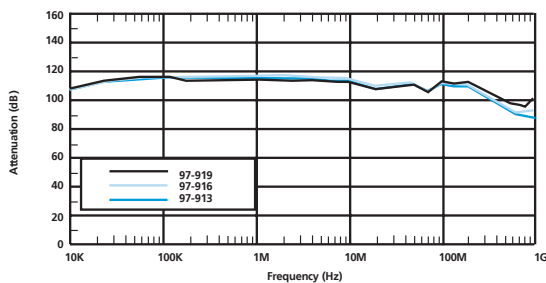

All dimensions shown are in inches (millimeters) unless otherwise specified.

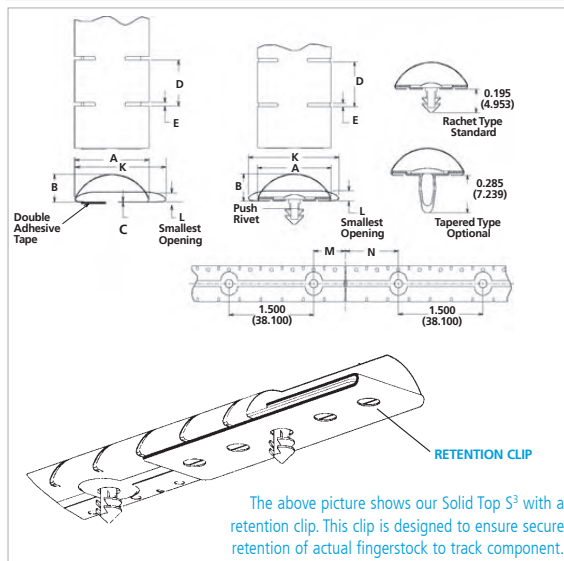

The above picture shows our Solid Top S<sup>3</sup> with a retention clip. This clip is designed to ensure secure retention of actual fingerstock to track component.

# FINGERSTOCK

## CLIP-ON SYMMETRICAL SHIELDING

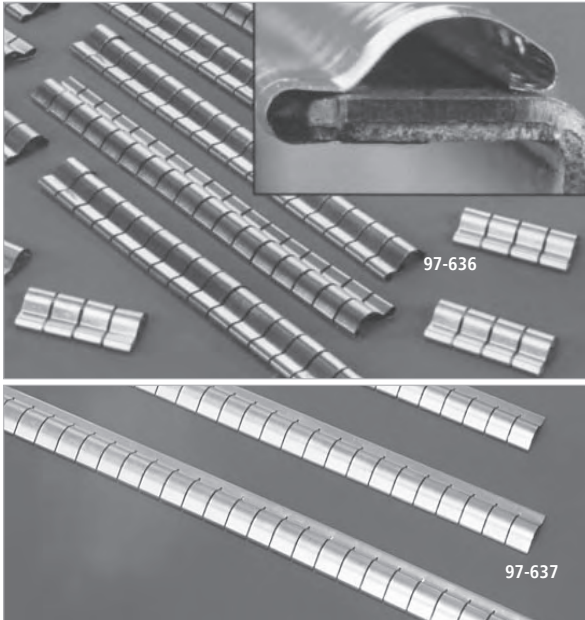

The 97-636 and 97-637 Clip-On Symmetrical Shielding Gaskets have been designed to function equally well in applications requiring sliding movement or direct compression.

- Supplied with standard "D" lance ensuring secure holding power when snapped into a prefabricated hole
- "D" lance provides both multi-directional grip and excellent conductivity
- Wide radius profile allows for maximum contact with minimum compression force
- Clip-On feature allows part to be used in high temperature (above 250°F) applications where adhesives will not function
- Available in our UltraSoft<sup>®</sup>, 98-Series low force version
- Ideally suited for cardcage handles, PC board grounding or any other application requiring clip-on feature and wiping action
- Shielding effectiveness of 100 dB @ 100 MHz
- Available in a wide variety of plating finishes, see page 17

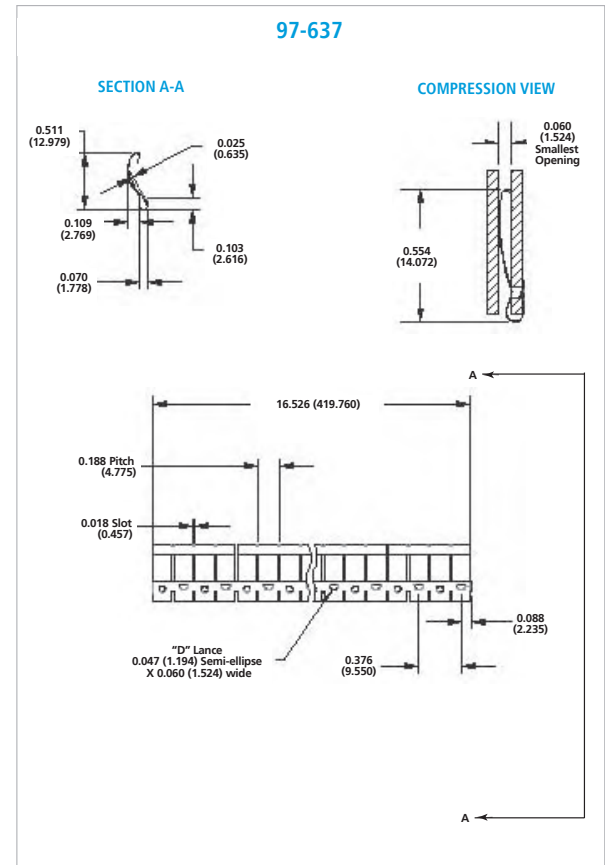
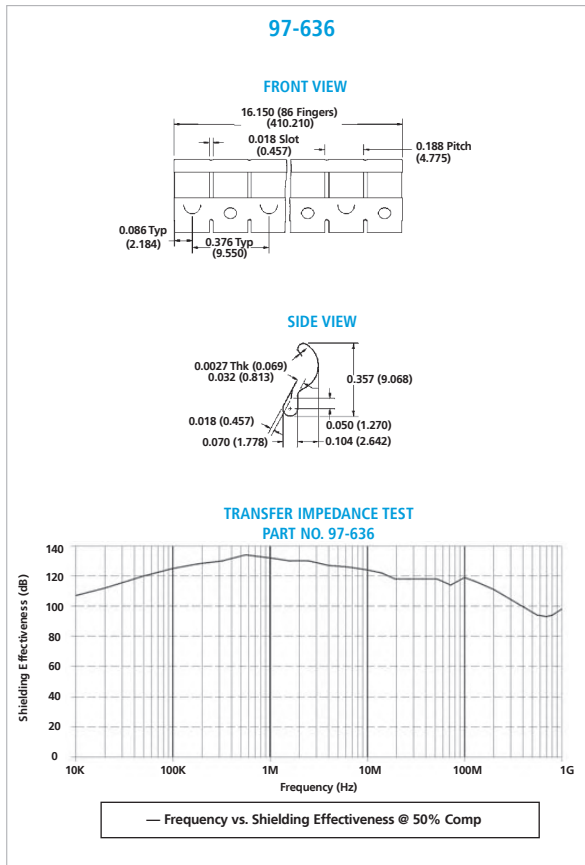

All dimensions shown are in inches (millimeters) unless otherwise specified.

# FINGERSTOCK NO SNAG GASKET

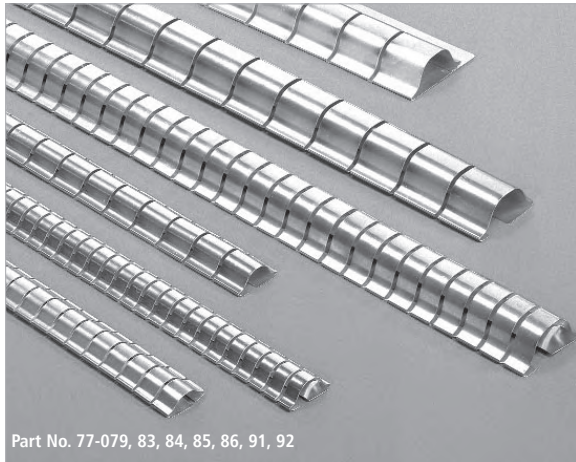

Part No. 77-079, 83, 84, 85, 86, 91, 92

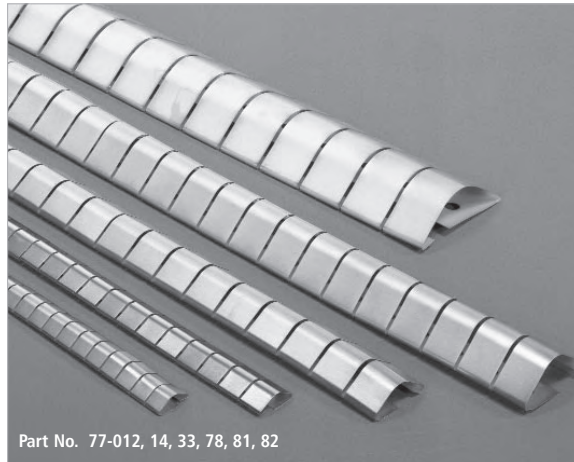

Part No. 77-012, 14, 33, 78, 81, 82

Laird No Snag Series shielding gaskets offer the designer a low compression, no snag design. Provided with Sticky Fingers® self-adhesive tape, these beryllium copper shielding gaskets provide easy and secure mounting.

- Shielding effectiveness of > 100 dB (77-012) and 80 dB (77-014) for a 100 MHz plane wave
- Easy, cost-effective installation since fasteners are not required
- Ideal as an all-purpose contact strip for metal cabinets and electronic enclosures
- Available in a wide variety of plated finishes, see page 17
- Supplied in standard 24.000 in. (609.600 mm) lengths or other specified lengths

### NO SNAG GASKET DIMENSIONS

SERIES	A	B	C	D	E	H	M	RADIUS	APPROX. LENGTH
77-012	0.320 (8.128)	0.110 (2.794)	0.002 (0.051)	0.187 (4.750)	0.018 (0.457)	0.210 (5.334)	0.110 (2.794)		24.000 (609.600)
* 77-014	0.600 (15.240)	0.220 (5.588)	0.004 (0.102)	0.375 (9.525)	0.032 (0.813)	0.280 (7.112)	0.180 (4.572)		24.000 (609.600)
77-033	0.370 (9.398)	0.130 (3.302)	0.002 (0.051)	0.250 (6.350)	0.025 (0.635)	0.210 (5.334)	0.110 (2.794)		16.000 (406.400)
* 77-078	0.800 (20.320)	0.320 (8.128)	0.004 (0.102)	0.375 (9.525)	0.032 (0.813)	0.440 (11.176)	0.190 (4.826)		24.000 (609.600)
* 77-079	0.320 (8.128)	0.100 (2.540)	0.035 (0.889)	0.156 (3.962)	0.018 (0.457)	0.210 (5.334)	0.100 (2.540)		16.000 (406.400)
77-081	0.280 (7.112)	0.110 (2.794)	0.002 (0.051)	0.187 (4.750)	0.018 (0.457)	0.180 (4.572)	0.100 (2.540)		24.000 (609.600)
* 77-082	1.100 (27.940)	0.400 (10.160)	0.005 (0.127)	0.500 (12.700)	0.040 (1.016)	0.780 (19.812)	0.420 (10.668)		24.000 (609.600)
* 77-083	0.370 (9.398)	0.130 (3.302)	0.004 (0.102)	0.125 (3.175)	0.025 (0.635)	0.100 (2.540)	0.202 (5.131)		16.000 (406.400)
* 77-084	0.370 (9.398)	0.130 (3.302)	0.004 (0.102)	0.250 (6.350)	0.025 (0.635)	0.100 (2.540)	0.202 (5.131)		16.000 (406.400)
* 77-085	0.600 (15.240)	0.220 (5.588)	0.004 (0.102)	0.375 (9.525)	0.032 (0.813)	0.150 (3.810)	0.295 (7.493)		18.000 (457.200)
* 77-086	0.320 (8.128)	0.090 (2.286)	0.003 (0.762)	0.187 (4.750)	0.018 (0.457)	0.210 (5.334)	0.100 (2.540)		16.000 (406.400)
* 77-091	0.600 (15.240)	0.220 (5.588)	0.004 (0.102)	0.375 (9.525)	0.032 (0.813)	0.780 (19.812)	0.150 (3.810)		18.000 (457.200)
* 77-092	0.600 (15.240)	0.220 (5.588)	0.004 (0.102)	0.187 (4.750)	0.032 (0.813)	0.295 (7.493)	0.150 (3.810)		18.000 (457.200)

\* Available in UltraSoft® low compression version as -78.

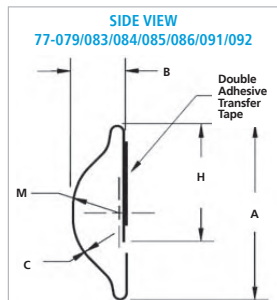
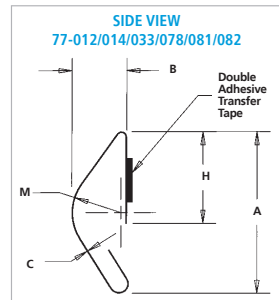
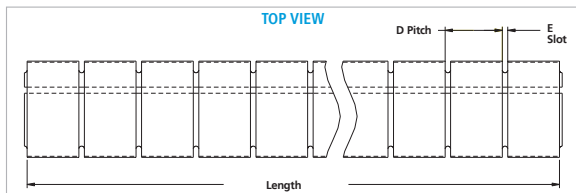

All dimensions shown are in inches (millimeters) unless otherwise specified.

# FINGERSTOCK

## ALL-PURPOSE SERIES

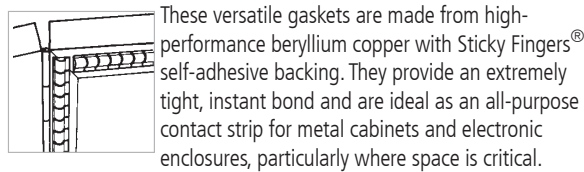

These versatile gaskets are made from high-performance beryllium copper with Sticky Fingers® self-adhesive backing. They provide an extremely tight, instant bond and are ideal as an all-purpose contact strip for metal cabinets and electronic enclosures, particularly where space is critical.

Magnetic field shielding effectiveness of these strips has been proven to be > 46 dB for a 14 kHz plane wave and 108 dB for a 10 GHz plane wave. When tested per MIL-STD-285 for electromagnetic shielding, these strips showed superior performance under minimum compression. They proved to be especially effective where variations exist in the space to be shielded and in applications that require high shielding performance despite frequent opening and closing of the cabinet.

Strips 97-500 and 97-538 are furnished in standard lengths of 24.000 in. (609.600 mm) and in continuous 25.0 ft. (7.6 m) coils. Series 97-520 and 97-540 are supplied in standard 16.000 in. (406.400 mm) lengths and in 25.0 ft. (7.6 m) coils. Strips 97-537, 97-535 and 97-545 are supplied in 12.000 in. (304.800 mm) lengths. All are available in your choice of finishes, see page 17.

Please note that designated strips are available with Magnefil®, a rubber strip filled with magnetic absorbing particles and inserted within the curve of the fingers. Magnefil provides increased magnetic field shielding.

These 97-Series products are also available in UltraSoft® low compression force 98-Series.

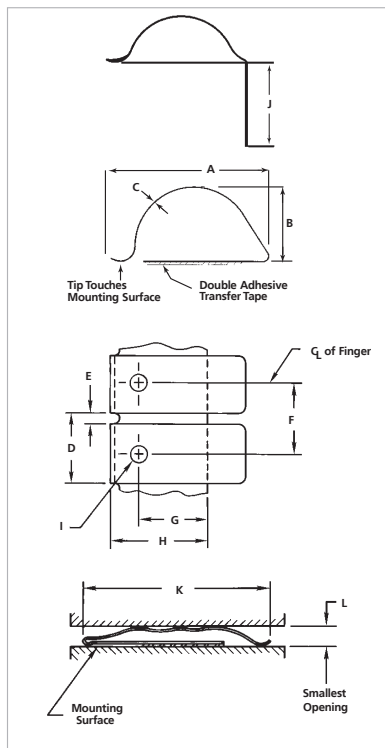

All dimensions shown are in inches (millimeters) unless otherwise specified.

### ALL-PURPOSE SERIES

SERIES	A MIN.	B	C	D	E	F	G	H	I	J	K	L	APPROX. LENGTH	APPROX. COIL FT (M)
97-500	0.600 (15.240)	0.230 (5.842)	0.004 (0.102)	0.375 (9.525)	0.032 (0.813)	0.380 (9.652)	0.310 (7.874)	0.500 (12.700)	0.080 (2.032)	N/A	0.770 (19.558)	0.040 (1.016)	24.000 (609.600)	25.0 (7.6)
97-505	0.600 (15.240)	0.230 (5.842)	0.004 (0.102)	0.375 (9.525)	0.032 (0.813)	0.380 (9.652)	0.310 (7.874)	N/A	0.080 (2.032)	0.500 (12.700)	0.770 (19.558)	0.040 (1.016)	24.000 (609.600)	25.0 (7.6)
97-510	0.600 (15.240)	0.230 (5.842)	0.004 (0.102)	0.375 (9.525)	0.032 (0.813)	0.380 (9.652)	0.310 (7.874)	0.500 (12.700)	0.080 (2.032)	N/A	0.770 (19.558)	0.040 (1.016)	24.000 (609.600)	25.0 (7.6)
97-520	0.370 (9.398)	0.140 (3.556)	0.003 (0.076)	0.250 (6.350)	0.022 (0.559)	0.250 (6.350)	0.090 (2.286)	0.310 (7.874)	0.060 (1.524)	N/A	0.500 (12.700)	0.070 (1.778)	16.000 (406.400)	25.0 (7.6)
97-525	0.370 (9.398)	0.140 (3.556)	0.003 (0.076)	0.250 (6.350)	0.022 (0.559)	0.250 (6.350)	0.090 (2.286)	N/A	0.060 (1.524)	0.320 (8.128)	0.500 (12.700)	0.070 (1.778)	16.000 (406.400)	25.0 (7.6)
97-527	0.280 (7.112)	0.055 (1.397)	0.002 (0.051)	0.125 (3.175)	0.025 (0.635)	N/A	N/A	0.183 (4.648)	N/A	N/A	0.300 (7.620)	0.040 (1.016)	16.000 (406.400)	N/A
97-535	0.780 (19.812)	0.250 (6.350)	0.005 (0.127)	0.375 (9.525)	0.040 (1.016)	0.380 (9.652)	0.380 (9.652)	N/A	0.140 (3.556)	0.480 (12.192)	0.940 (23.876)	0.080 (2.032)	12.000 (304.800)	25.0 (7.6)
97-536	0.670 (17.018)	0.310 (7.874)	0.004 (0.102)	0.375 (9.525)	0.040 (1.016)	0.380 (9.652)	0.380 (9.652)	0.530 (13.462)	0.140 (3.556)	N/A	0.940 (23.876)	0.140 (3.556)	24.000 (609.600)	25.0 (7.6)
97-537	1.130 (28.702)	0.410 (10.414)	0.007 (0.178)	0.500 (12.700)	0.040 (1.016)	0.500 (12.700)	0.560 (14.224)	0.780 (19.812)	0.140 (3.556)	N/A	1.940 (49.276)	0.100 (2.540)	12.000 (304.800)	N/A
97-538	0.780 (19.812)	0.250 (6.350)	0.005 (0.127)	0.375 (9.525)	0.040 (1.016)	0.380 (9.652)	0.380 (9.652)	0.530 (13.462)	0.140 (3.556)	N/A	0.940 (23.876)	0.080 (2.032)	24.000 (609.600)	25.0 (7.6)
97-540	0.280 (7.112)	0.110 (2.794)	0.003 (0.076)	0.188 (4.775)	0.018 (0.457)	0.190 (4.826)	0.080 (2.032)	0.230 (5.842)	0.060 (1.524)	N/A	0.370 (9.398)	0.065 (1.651)	16.000 (406.400)	25.0 (7.6)
97-544	0.260 (6.604)	0.110 (2.794)	0.003 (0.076)	0.188 (4.775)	0.018 (0.457)	0.190 (4.826)	0.080 (2.032)	N/A	0.060 (1.524)	0.240 (6.096)	0.370 (9.398)	0.065 (1.651)	16.000 (406.400)	25.0 (7.6)
97-545	1.130 (28.702)	0.410 (10.414)	0.007 (0.178)	0.500 (12.700)	0.040 (1.016)	0.500 (12.700)	0.560 (14.224)	N/A	0.140 (3.556)	0.750 (19.050)	1.940 (49.276)	0.100 (2.540)	12.000 (304.800)	N/A
97-548	0.780 (19.812)	0.250 (6.350)	0.005 (0.127)	0.375 (9.525)	0.040 (1.016)	0.380 (9.652)	0.380 (9.652)	0.530 (13.462)	0.140 (3.556)	N/A	0.940 (23.876)	0.080 (2.032)	24.000 (609.600)	25.0 (7.6)

# FINGERSTOCK CLIP-ON SERIES

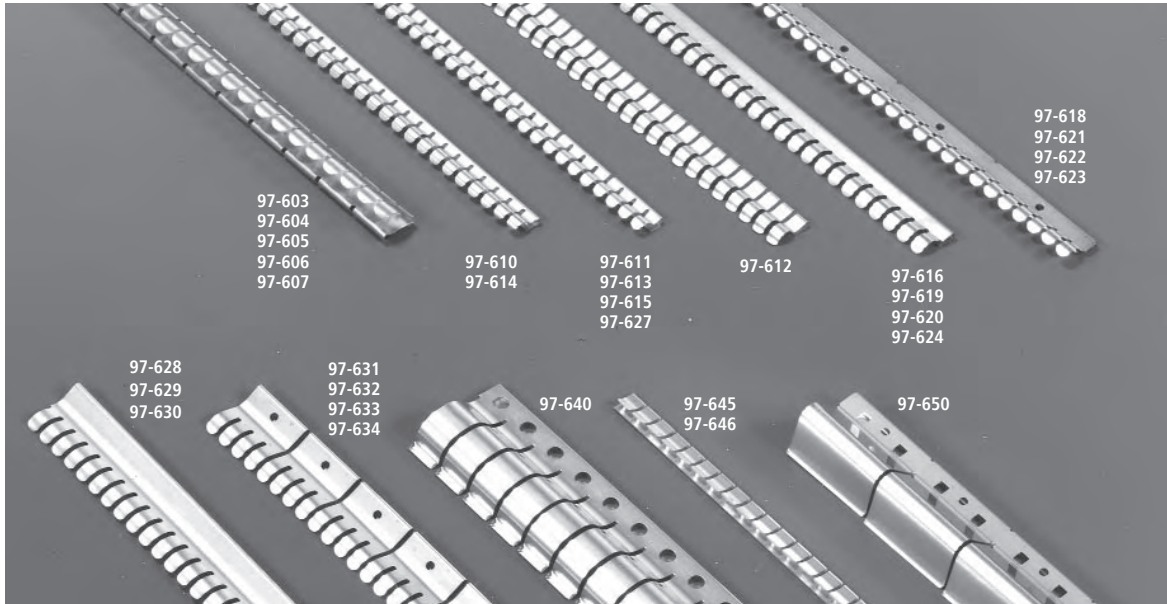

97-603  
97-604  
97-605  
97-606  
97-607

97-610  
97-614

97-611  
97-613  
97-615  
97-627

97-612

97-616  
97-619  
97-620  
97-624

97-618  
97-621  
97-622  
97-623

97-628  
97-629  
97-630

97-631  
97-632  
97-633  
97-634

97-640

97-645  
97-646

97-650

This series from Laird is designed for use where high temperature or other design considerations preclude the use of adhesive-mounted gasketing. Yet it provides the same shielding characteristics and effectiveness as on Sticky Fingers® mounted series. Clip-On Gaskets offer shielding effectiveness >100 dB for 100 MHz plane wave. All are available in your choice of finishes, see page 17. These 97-Series products are also available in UltraSoft® low compression force 98-Series.

### SNAP-TITE® WITH "D" LANCE

This configuration has been designed specifically to provide outstanding holding power. "D" lances snap into drilled or punched holes in the mounting surface to create a strong omnidirectional grip with excellent conductivity.

### GRIP-TITE® WITH "T" LANCE

Ideal for use with softer materials, such as aluminum or plated plastic. "T" lances bite into the mounting surface and preserve electrical conductivity.

### MINI CLIP-ON

Laird Mini Clip-On (97-645/646) Gaskets are designed for use on today's thinner, lighter materials.

- Lowest compression force available in clip-on configuration
- Virtually no compression set – 100% recovery of original height at up to 60% compression
- "D" lance for extra holding power
- Optimum conductivity and mechanical properties of beryllium copper
- High cycle life – 50,000 cycles without fracture, wear, or compression set

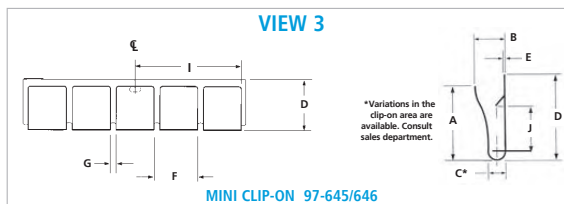
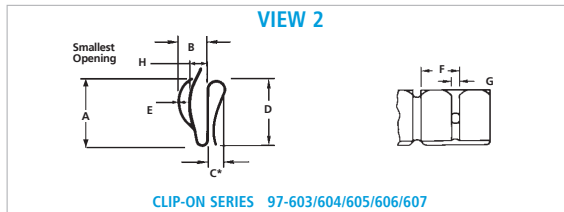
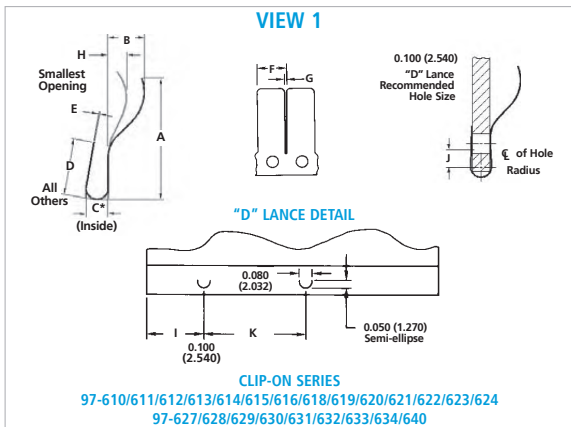

All dimensions shown are in inches (millimeters) unless otherwise specified.



# FINGERSTOCK CLIP-ON SERIES

## CLIP-ON SERIES DIMENSIONS

VIEW	SERIES	A	B	C	D	E	F	G	H	APPROX. LENGTH	NO LANCE	SQUARE LANCE SQ	GRIP-TITE™ "T" LANCE GT	SNAP-TITE™ "D" LANCE ST	LANCE LOCATIONS DIMENSIONS		LANCE TO LANCE DIMS. K	BODY STYLE	
											NL				I	J		SLOT	SOL
2	97-603	0.380 (9.652)	0.200 (5.080)	0.100 (2.540)	0.330 (8.382)	0.005 (0.127)	0.250 (6.350)	0.040 (1.016)	0.060 (1.524)	16.000 (406.400)	—	—	—	X	0.250 (6.350)	0.099 (2.515)	0.500 (12.700)	X	—
2	97-604	0.330 (8.382)	0.280 (7.112)	0.070 (1.778)	0.380 (9.652)	0.005 (0.127)	0.250 (6.350)	0.040 (1.016)	0.100 (2.540)	16.000 (406.400)	—	—	X	—	0.230 (5.842)	0.204 (5.182)	0.500 (12.700)	X	—
2	97-605	0.380 (9.652)	0.200 (5.080)	0.070 (1.778)	0.380 (9.652)	0.005 (0.127)	0.250 (6.350)	0.040 (1.016)	0.060 (1.524)	16.000 (406.400)	—	—	X	—	0.230 (5.842)	0.204 (5.182)	0.500 (12.700)	X	—
2	97-606	0.380 (9.652)	0.200 (5.080)	0.070 (1.778)	0.380 (9.652)	0.005 (0.127)	0.250 (6.350)	0.040 (1.016)	0.060 (1.524)	16.000 (406.400)	—	—	—	X	0.250 (6.350)	0.161 (4.089)	0.500 (12.700)	X	—
2	97-607	0.330 (8.382)	0.280 (7.112)	0.070 (1.778)	0.380 (9.652)	0.005 (0.127)	0.250 (6.350)	0.040 (1.016)	0.100 (2.540)	16.000 (406.400)	—	—	—	X	0.250 (6.350)	0.161 (4.089)	0.500 (12.700)	X	—
1	97-610	0.300 (7.620)	0.100 (2.540)	0.070 (1.778)	0.190 (4.826)	0.005 (0.127)	0.187 (4.750)	0.047 (1.194)	0.065 (1.651)	16.000 (406.400)	X	—	#	#	—	—	—	—	X
1	97-611	0.300 (7.620)	0.100 (2.540)	0.070 (1.778)	0.190 (4.826)	0.005 (0.127)	0.182 (4.623)	0.047 (1.194)	0.060 (1.524)	16.000 (406.400)	—	—	X	—	0.364 (9.246)	0.062 (1.575)	0.728 (18.491)	X	—
1	97-612	0.440 (11.176)	0.100 (2.540)	0.070 (1.778)	0.190 (4.826)	0.003 (0.076)	0.187 (4.750)	0.047 (1.194)	0.045 (1.143)	16.000 (406.400)	#	X	—	—	0.093 (2.362)	0.050 (1.270)	0.750 (19.050)	X	—
1	97-613	0.300 (7.620)	0.100 (2.540)	0.070 (1.778)	0.190 (4.826)	0.005 (0.127)	0.182 (4.623)	0.047 (1.194)	0.060 (1.524)	16.000 (406.400)	—	—	—	X	0.364 (9.246)	0.054 (1.372)	0.728 (18.491)	X	—
1	97-614	0.300 (7.620)	0.100 (2.540)	0.050 (1.270)	0.190 (4.826)	0.005 (0.127)	0.187 (4.750)	0.047 (1.194)	0.065 (1.651)	16.000 (406.400)	X	—	#	#	—	—	—	—	X
1	97-615	0.297 (7.544)	0.100 (2.540)	0.050 (1.270)	0.187 (4.750)	0.005 (0.127)	0.182 (4.623)	0.047 (1.194)	0.050 (1.270)	16.000 (406.400)	—	—	—	X	0.364 (9.246)	0.309 (7.849)	0.728 (18.491)	—	X
1	97-616	0.420 (10.668)	0.120 (3.048)	0.100 (2.540)	0.250 (6.350)	0.005 (0.127)	0.187 (4.750)	0.047 (1.194)	0.095 (2.413)	16.000 (406.400)	X	—	—	—	—	—	—	—	X
1	97-618	0.420 (10.668)	0.140 (3.556)	0.060 (1.524)	0.210 (5.334)	0.005 (0.127)	0.187 (4.750)	0.047 (1.194)	0.080 (1.778)	16.000 (406.400)	—	—	—	X	0.500 (12.700)	0.065 (1.651)	1.000 (25.400)	—	X
1	97-619	0.440 (11.176)	0.080 (2.032)	0.050 (1.270)	0.190 (4.826)	0.005 (0.127)	0.187 (4.750)	0.047 (1.194)	0.045 (1.143)	16.000 (406.400)	X	—	#	#	—	—	—	—	X
1	97-620	0.440 (11.176)	0.080 (2.032)	0.070 (1.778)	0.190 (4.826)	0.005 (0.127)	0.187 (4.750)	0.047 (1.194)	0.045 (1.143)	16.000 (406.400)	X	—	#	#	—	—	—	—	X
1	97-621	0.440 (11.176)	0.120 (3.048)	0.070 (1.778)	0.230 (5.842)	0.005 (0.127)	0.193 (4.902)	0.046 (1.168)	0.070 (1.778)	16.000 (406.400)	—	—	X	—	0.652 (16.561)	0.084 (2.134)	1.351 (34.315)	X	—
1	97-622	0.440 (11.176)	0.120 (3.048)	0.070 (1.778)	0.190 (4.826)	0.005 (0.127)	0.193 (4.902)	0.046 (1.168)	0.075 (1.905)	16.000 (406.400)	—	—	—	X	0.290 (7.366)	0.060 (1.524)	0.725 (18.415)	X	—
1	97-623	0.420 (10.668)	0.080 (2.032)	0.070 (1.778)	0.187 (4.750)	0.005 (0.127)	0.187 (4.750)	0.047 (1.194)	0.045 (1.143)	16.000 (406.400)	—	—	—	X	0.530 (13.462)	0.064 (1.626)	1.000 (25.400)	—	X
1	97-624	0.420 (10.668)	0.140 (3.556)	0.060 (1.524)	0.210 (5.334)	0.005 (0.127)	0.187 (4.750)	0.047 (1.194)	0.080 (2.032)	16.000 (406.400)	X	—	—	—	—	—	—	—	X
1	97-627	0.297 (7.544)	0.099 (2.515)	0.070 (1.778)	0.187 (4.750)	0.005 (0.127)	0.187 (4.750)	0.047 (1.194)	0.049 (1.245)	16.000 (406.400)	—	—	—	X	0.280 (7.112)	0.049 (1.245)	0.748 (19.000)	—	X
1	97-628	0.600 (15.240)	0.210 (5.334)	0.100 (2.540)	0.230 (5.842)	0.005 (0.127)	0.187 (4.750)	0.047 (1.194)	0.070 (1.778)	16.000 (406.400)	X	—	#	#	—	—	—	—	X
1	97-629	0.600 (15.240)	0.210 (5.334)	0.050 (1.270)	0.190 (4.826)	0.005 (0.127)	0.187 (4.750)	0.047 (1.194)	0.070 (1.778)	16.000 (406.400)	X	—	#	#	—	—	—	—	X
1	97-630	0.600 (15.240)	0.210 (5.334)	0.070 (1.778)	0.190 (4.826)	0.005 (0.127)	0.187 (4.750)	0.047 (1.194)	0.070 (1.778)	16.000 (406.400)	X	—	#	#	—	—	—	—	X
1	97-631	0.600 (15.240)	0.210 (5.334)	0.070 (1.778)	0.190 (4.826)	0.005 (0.127)	0.182 (4.623)	0.047 (1.194)	0.080 (2.032)	16.000 (406.400)	—	—	X	—	0.364 (9.246)	0.058 (1.473)	0.728 (18.491)	X	—
1	97-632	0.600 (15.240)	0.210 (5.334)	0.070 (1.778)	0.190 (4.826)	0.005 (0.127)	0.182 (4.623)	0.047 (1.194)	0.080 (2.032)	16.000 (406.400)	—	—	—	X	0.364 (9.246)	0.058 (1.473)	0.728 (18.491)	X	—
1	97-633	0.600 (15.240)	0.210 (5.334)	0.050 (1.270)	0.190 (4.826)	0.005 (0.127)	0.182 (4.623)	0.047 (1.194)	0.080 (2.032)	16.000 (406.400)	—	—	X	—	0.364 (9.246)	0.058 (1.473)	0.728 (18.491)	X	—
1	97-634	0.600 (15.240)	0.210 (5.334)	0.050 (1.270)	0.190 (4.826)	0.005 (0.127)	0.182 (4.623)	0.047 (1.194)	0.080 (2.032)	16.000 (406.400)	—	—	—	X	0.364 (9.246)	0.058 (1.473)	0.728 (18.491)	X	—
1	97-640	1.090 (27.686)	0.260 (6.604)	0.070 (1.778)	0.280 (7.112)	0.005 (0.127)	0.375 (9.525)	0.040 (1.016)	0.060 (1.524)	16.000 (406.400)	X	—	#	#	—	—	—	—	X
3	97-645	0.210 (5.334)	0.070 (1.778)	0.045 (1.143)	0.250 (6.350)	0.003 (0.076)	0.200 (5.080)	0.030 (0.762)	0.010 (0.254)	24.000 (609.600)	—	—	—	X	0.485 (12.319)	0.133 (3.378)	1.000 (25.400)	X	—
3	97-646	0.275 (6.985)	0.080 (2.036)	0.040 (1.016)	0.280 (7.112)	0.006 (0.152)	0.250 (6.350)	0.030 (0.762)	0.030 (0.762)	16.000 (406.400)	—	—	—	X	0.500 (12.700)	0.143 (3.617)	1.000 (25.400)	—	X
1	97-650	0.980 (24.892)	0.400 (10.160)	0.200 (5.080)	0.300 (7.620)	0.004 (0.102)	1.000 (25.400)	0.030 (0.762)	0.200 (5.080)	16.000 (406.400)	#	#	—	—	0.192 (4.877)	0.120 (3.048)	0.486 (12.344)	X	—

X Standard

# Optional

# FINGERSTOCK

## LOW PROFILE HOOK-ON GASKET

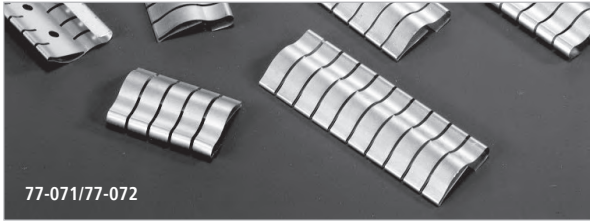

Laird offers its line of low profile beryllium copper shielding fingerstock. Simple installation is accomplished by hooking one end of the gasket onto the edge of the housing. The other end is secured with pressure sensitive adhesive (PSA) with extra-wide release liner and designed with a teardrop feature to improve surface contact. Ideally suited for low profile, bi-directional applications such as the rack mounting of linecards in telecommunications equipment. The gaskets offer high shielding performance in applications where space may be limited.

FIGURE 1

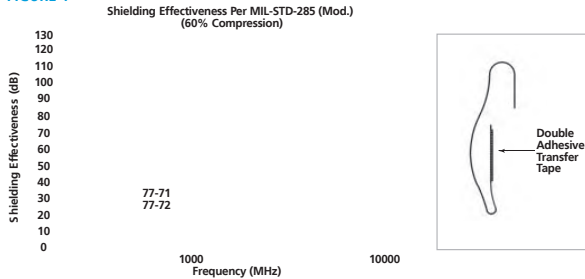

- Dual attachment provides a no snag gasket with secure retention, which allows bi-directional wiping action
- Incorporates extra wide release liner to facilitate easy installation
- Wide variety of plating finishes are available to meet your galvanic compatibility requirements
- Offered in standard lengths of 16.200 in. (411.480 mm) or cut to your desired length
- Available in UltraSoft® (-78) low force version

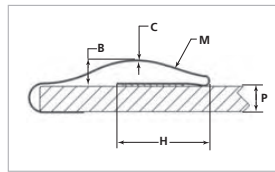
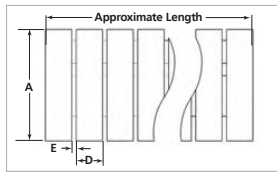

### DIMENSIONS

SERIES	A	B	C	D	E	H	M	P	APPROX. LENGTH	NO. OF FINGERS
77-071	0.450 (11.430)	0.060 (1.524)	0.004 (0.102)	0.125 (3.175)	0.018 (0.457)	0.267 (6.782)	0.200 (5.080)	0.062 (1.575)	16.200 (411.480)	130
77-072	0.600 (15.240)	0.090 (2.286)	0.004 (0.102)	0.125 (3.175)	0.018 (0.457)	0.329 (8.357)	0.200 (5.080)	0.062 (1.575)	16.200 (411.480)	130

## LOW PROFILE GASKET

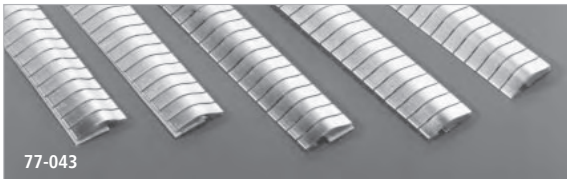

- Extra wide release liner of pressure sensitive tape provides for easy, cost-effective installation
- Low compression force
- Available in a wide variety of plated finishes to meet your galvanic compatibility needs
- Available in UltraSoft (-78) low force version
- Offered in standard lengths of 16.000 in. (406.400 mm), or cut to your desired length

Laird offers its line of low profile beryllium copper shielding fingerstock. The gaskets are provided with pressure sensitive adhesive tape with an extra wide release liner to facilitate secure placement and ease of application.

- Ideally suited for limited space applications as low as 0.060 in. (1.524 mm)
- Works well in both compression and bi-directional applications
- High shielding effectiveness; average 90 dB from 10 kHz to 1 GHz

### LOW PROFILE SERIES

SERIES	A	B	C	D
77-043	0.450 (11.430)	0.080 (2.032)	0.121 (3.073)	0.262 (6.665)
77-049	0.600 (15.240)	0.120 (3.048)	0.162 (4.115)	0.347 (8.814)

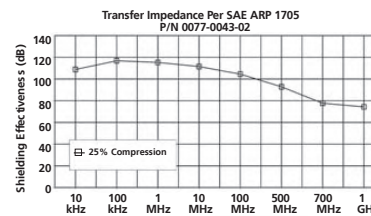
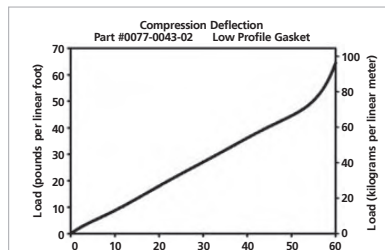
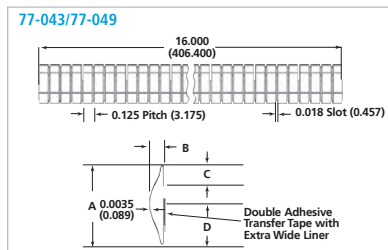

All dimensions shown are in inches (millimeters) unless otherwise specified.

# FINGERSTOCK

## LARGE ENCLOSURE SERIES

These standard beryllium copper contact gaskets offer ideal RFI/EMI shielding of doors and movable components in electronic shielded rooms, trailers, computers and communication equipment.

They have been scientifically designed for wiping closures, but are also usable in compression applications. Moreover, these contact strips feature extremely good endurance life, as well as a high deflection range. In tests, attenuation up to 112 dB has been measured for a 100 MHz plane wave. Fastening of the strip is usually accomplished using screws or rivets. Soldering is optional.

Both are available in continuous lengths to a maximum of 25.0 ft. (7.6 m) and in all standard finishes, see page 17.

These 97-Series products are also available in UltraSoft® low compression force 98-Series.

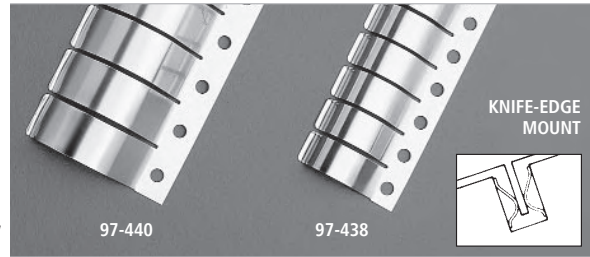

### LARGE ENCLOSURE SERIES

SERIES	A REF.	B MIN	C	D	E	F	G	H DIA.	I	L	APPROX. LENGTH FT. (M)
97-438	1.090 (27.686)	0.250 (6.350)	0.005 (0.127)	0.375 (9.525)	0.040 (1.016)	0.160 (4.064)	0.375 (9.525)	0.140 (3.556)	1.270 (32.258)	0.080 (2.032)	25.000 (7.6)
97-440	1.630 (41.402)	0.410 (10.414)	0.007 (0.178)	0.500 (12.700)	0.040 (1.016)	0.190 (4.826)	0.500 (12.700)	0.140 (3.556)	1.900 (48.260)	0.100 (2.540)	25.000 (7.6)

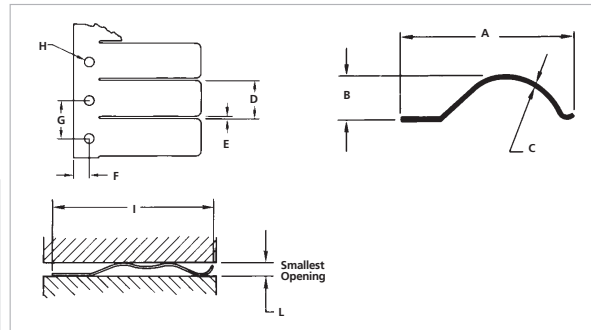

## DOUBLE-SIDED CONTACT SERIES

Mechanically balanced strips with high deflection range and long endurance life-provide a perfect fit as spring clips hold the gaskets firmly in place. It means more simplified design and construction of cabinets and enclosures. Attenuation > 102 dB for a 100 MHz plane wave has been measured using Series 97-436 gaskets. For standard finishes, see page 17. These 97-Series products are also available in UltraSoft low compression force 98-Series.

### QUICK SPRING CLIP FASTENERS (97-445)

Designed for use with Series 97-436 finger gaskets, spring clip fasteners permit full strip compression. Easy to install, they permit lifting of gasket for cleaning of contact surface. Packaged in lots of 1,000. Available in standard finishes, see page 17.

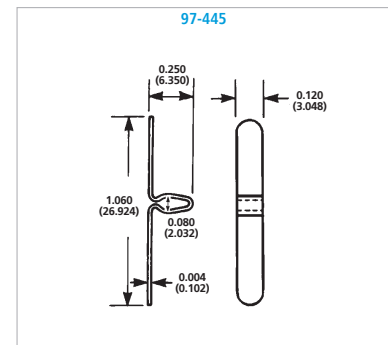
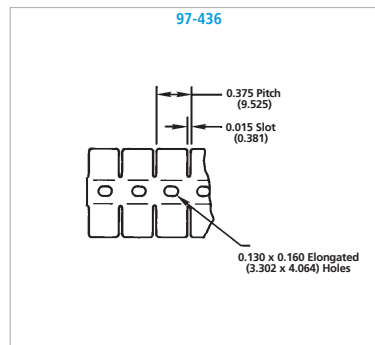
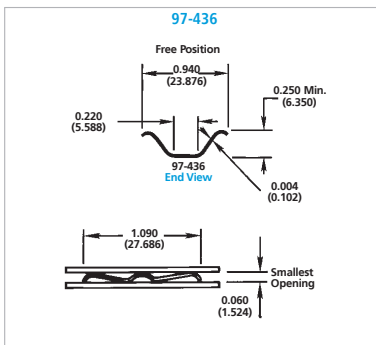
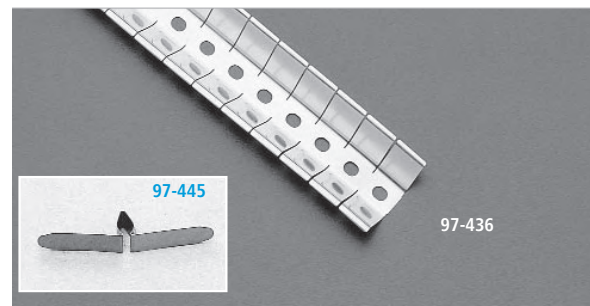

All dimensions shown are in inches (millimeters) unless otherwise specified.

▲ Quick Spring Clip Fastener provides full strip compression; allows lifting of product for cleaning of contact surface.

# FINGERSTOCK FOLDOVER SERIES

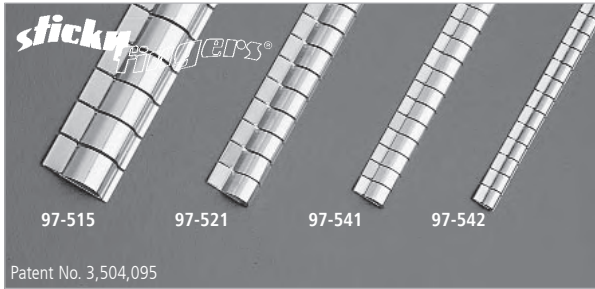

Patent No. 3,504,095

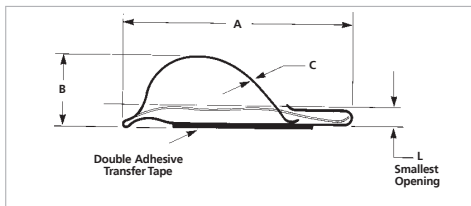
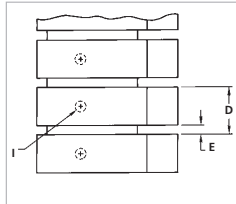

This version of Sticky Fingers<sup>®</sup> beryllium copper shielding gaskets features a special U-shaped end that permits the finger of the strip to slide when enclosure doors are closed. It also retains the strip's fingers when enclosure doors are open, thus preventing accidental damage to the fingers. Shielding effectiveness is >115 dB for a 100 MHz plane wave. Four models provide you a choice of widths to suit your application. They are available in standard 16.000 in. (406.400 mm) lengths, except 97-515 which is furnished in 24.000 in. (609.600 mm) lengths. Also, all styles are available in continuous 25.0 ft. (7.6 m) coils, and in your choice of all finishes except tin lead and satin tin, see page 17. These 97-Series products are also available in UltraSoft<sup>®</sup> low compression force 98-Series.

### FOLDOVER SERIES

SERIES	A	B	C	D PITCH	E SLOT	I DIA.	L	APPROX. LENGTH IN. (MM)	APPROX. COIL FT. (M)
97-515	0.760 (19.304)	0.230 (5.842)	0.004 (0.102)	0.375 (9.525)	0.032 (0.813)	0.080 (2.032)	0.060 (1.524)	24.000 (609.600)	25.0 (7.6)
97-521	0.510 (12.954)	0.140 (3.556)	0.003 (0.076)	0.250 (6.350)	0.022 (0.559)	0.060 (1.524)	0.070 (1.778)	16.000 (406.400)	25.0 (7.6)
97-541	0.380 (9.652)	0.120 (3.048)	0.003 (0.076)	0.188 (4.775)	0.018 (0.457)	0.060 (1.524)	0.050 (1.270)	16.000 (406.400)	25.0 (7.6)
97-542	0.250 (6.350)	0.080 (2.032)	0.003 (0.076)	0.188 (4.775)	0.018 (0.457)	0.060 (1.524)	0.050 (1.270)	16.000 (406.400)	25.0 (7.6)

## STAINLESS STEEL I/O SHIELDING

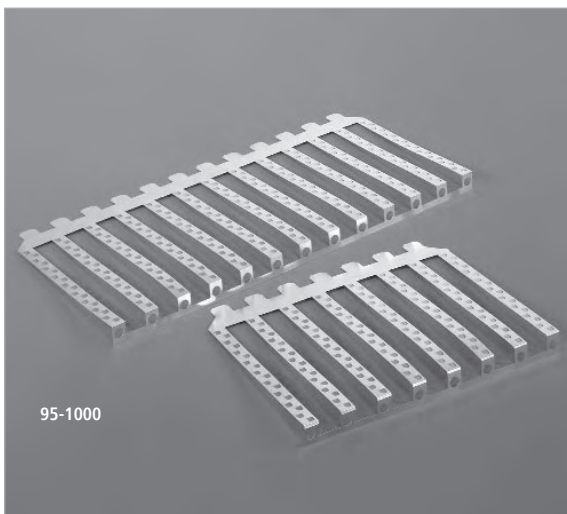

Laird offers its line of card cage shielding, designed to provide EMI/RFI shielding between the chassis and the slot covers.

- Provides a single gasket solution for a multiple of slot covers
- Material thickness of 0.004 in. (0.102 mm) insures low closure force and eliminates possible distortion of mating parts
- 18 contact fingers per rib provides contact points over length of the I/O bracket shield
- Superior contact finger design faces the card cage portion insuring snag-free insertion of add-in cards
- Stainless steel design provides galvanic compatibility to most enclosure materials
- Adaptable tooling allows for 1-21 slot configurations with no tooling cost
- Variable rib widths are available upon request

To discuss your particular application, please contact our sales department.

### HOW TO ORDER

All parts start with 009510 as the first six digits. The next two digits designate the number of slots in the part. The last two digits will be 00 for all standard configurations. Example: 0095-1018-00 represents an 18 slot part.

# FINGERSTOCK

## FLEXIBLE LOW COMPRESSION SERIES

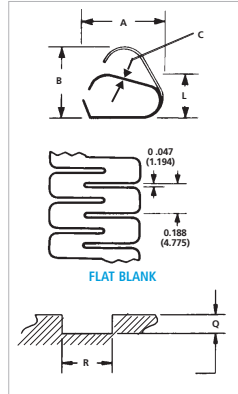
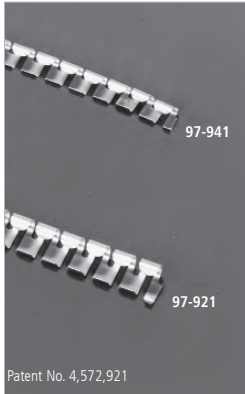

Series 97-941/921 are low compression, flexible beryllium copper contact strips for applications where a continuous shield must conform to irregular shapes and turn tight radius corners in either direction.

Simple snap-in installation is possible for Series 97-921 with 0.250 in. (6.350 mm) slots and 97-941 with 0.190 in. (4.826 mm) slots. However, soft solder or conductive adhesive can be used for mounting to flat surfaces.

Shielding effectiveness is >115 dB for a 100 MHz plane wave.

Available in standard 24.000 in. (609.600 mm) lengths in all standard finishes, see page 17.

### FLEXIBLE LOW COMPRESSION SERIES

SERIES	A	B	C	L	Q	R	APPROX. LENGTH
97-921	0.260 (6.604)	0.230 (5.842)	0.003 (0.076)	0.140 (3.556)	0.120 (3.048)	0.250 (6.350)	24.0 (609.600)
97-941	0.195 (4.953)	0.170 (4.318)	0.003 (0.076)	0.110 (2.794)	0.090 (2.286)	0.190 (4.826)	24.0 (609.600)

## CLIP-ON TWIST SERIES

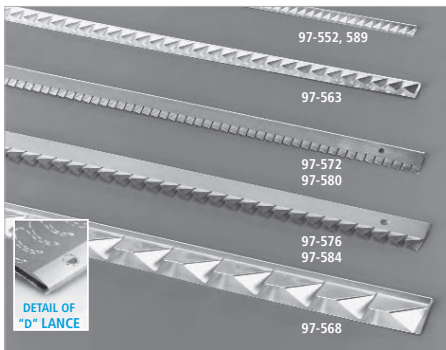

Ideal for general shielding applications where mounting space is at a premium, Clip-On Twist Series strips combine the performance advantages of scientific twist design with the strength of clip-on mounting.

Clip-On Twist Series gaskets are offered in four different widths, each available in either equal leg or offset leg configurations. In addition, each offset leg configuration is available with Poron® rubber environmental gaskets for dust and moisture resistance, as well as with "D" lances that snap into 0.100 in. (2.540 mm) diameter holes to provide added mounted strength.

This series offers shielding effectiveness > 115 dB for a 100 MHz plane wave and is provided in standard 16.000 in. (406.400 mm) lengths. All are available in your choice of finishes, see page 17.

These 97-Series products are also available in UltraSoft® low compression force 98-Series.

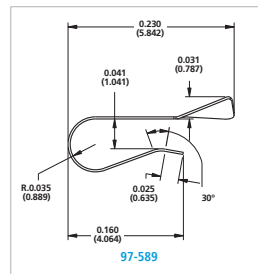
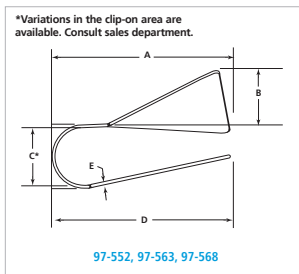
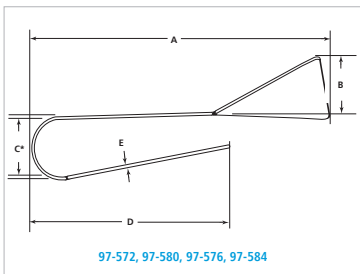

### CLIP-ON TWIST SERIES

SERIES	A	B	C	D	E	PITCH	SLOT	APPROX. LENGTH	PART NO.		
									WITH "D" LANCE	WITH PORON®	WITH "D" LANCE WITH PORON®
97-552	0.150 (3.810)	0.030 (0.762)	0.070 (1.778)	0.150 (3.810)	0.003 (0.076)	0.095 (2.413)	0.015 (0.381)	16.000 (406.400)	97-553	—	—
97-563	0.210 (5.334)	0.070 (1.778)	0.070 (1.778)	0.210 (5.334)	0.003 (0.076)	0.165 (4.191)	0.015 (0.381)	16.000 (406.400)	97-564	—	—
97-568*	0.414 (10.516)	0.210 (5.334)	0.070 (1.778)	0.414 (10.516)	0.003 (0.076)	0.500 (12.700)	0.015 (0.381)	16.000 (406.400)	—	—	—
97-572	0.275 (6.985)	0.030 (0.762)	0.070 (1.778)	0.175 (4.445)	0.003 (0.076)	0.095 (2.413)	0.015 (0.381)	16.000 (406.400)	97-574	97-573	97-575
97-576	0.378 (9.601)	0.075 (1.905)	0.070 (1.778)	0.250 (6.350)	0.003 (0.076)	0.165 (4.191)	0.015 (0.381)	16.000 (406.400)	97-578	97-577	97-579
97-580	0.275 (6.985)	0.030 (0.762)	0.050 (1.270)	0.175 (4.445)	0.003 (0.076)	0.095 (2.413)	0.015 (0.381)	16.000 (406.400)	97-582	97-581	97-583
97-584	0.378 (9.601)	0.075 (1.905)	0.050 (1.270)	0.250 (6.350)	0.003 (0.076)	0.165 (4.191)	0.015 (0.381)	16.000 (406.400)	97-586	97-585	97-587
97-589	0.230 (5.842)	0.031 (0.787)	0.070 (1.778)	0.160 (4.064)	0.003 (0.076)	0.095 (2.413)	0.015 (0.381)	24.000 (609.000)	—	—	—
97-590	0.160 (4.064)	0.030 (0.762)	0.040 (1.016)	0.160 (4.064)	0.003 (0.076)	0.095 (2.413)	0.015 (0.381)	16.000 (406.400)	97-593	—	—

\*Standard with "D" Lance

All dimensions shown are in inches (millimeters) unless otherwise specified.

# FINGERSTOCK TWIST SERIES

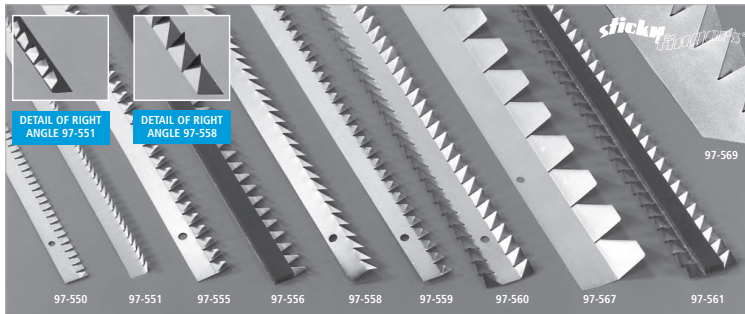

Adhesive-mounted beryllium copper contact strips with scientific twist design offer narrow electronic gaskets for general shielding applications.

Different widths are available to suit your specific application for single edge contact strips. Also available are two 90 degree versions (Series 97-551 and 97-558) to provide alternate mounting capability. Series 97-555, 97-558 and 97-559 provide shielding effectiveness > 100 dB for a 100 MHz plane wave, ideal for all types of panel or electronic enclosures. Series 97-550, 97-551 and 97-560 provide shielding effectiveness > 115 dB for a 100 MHz

plane wave. Series 97-560 strips are especially suitable for cabinets with panel divider bars. Their unique double-edge design permits panels to be removed easily and replaced without damage to the installed strip.

All Twist Series strips are furnished in 24.000 in. (609.600 mm) lengths. Strips (except 97-551 and 97-558) are also available in standard 25.0 ft. (7.6 m) coils. Right angle product configurations are not available in coils. All are available in your choice of finishes, see page 17.

### COMBINATION ENVIRONMENTAL RUBBER GASKET

Series 97-556 and 97-561 are versions of 97-555 and 97-560, respectively, incorporating a Poron® rubber gasket to act as an environmental shield, offering a high degree of protection against dust and moisture. All are available in your choice of finishes, see page 17.

These 97-Series products are also available in UltraSoft® low compression force 98-Series.

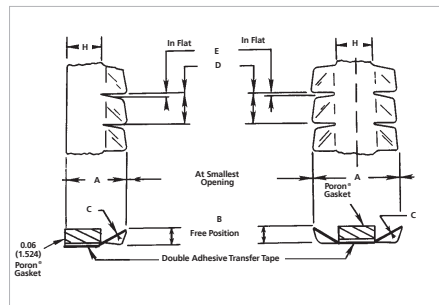
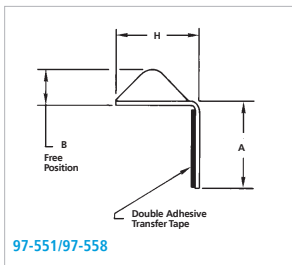

### TWIST SERIES

SERIES	A	B	C	D PITCH	E SLOT	H	APPROX. LENGTH IN. (MM)	APPROX. COIL FT. (M)	GASKET
97-550	0.230 (5.842)	0.030 (0.762)	0.003 (0.076)	0.095 (2.413)	0.015 (0.381)	0.140 (3.556)	24.000 (609.600)	25.0 (7.6)	NO
97-551	0.160 (4.064)	0.030 (0.762)	0.003 (0.076)	0.095 (2.413)	0.015 (0.381)	0.080 (2.032)	24.000 (609.600)	—	NO
97-555	0.340 (8.636)	0.070 (1.778)	0.003 (0.076)	0.165 (4.191)	0.015 (0.381)	0.180 (4.572)	24.000 (609.600)	25.0 (7.6)	NO
97-556	0.340 (8.636)	0.070 (1.778)	0.003 (0.076)	0.165 (4.191)	0.015 (0.381)	0.180 (4.572)	24.000 (609.600)	25.0 (7.6)	YES
97-558	0.200 (5.080)	0.070 (1.778)	0.003 (0.076)	0.165 (4.191)	0.015 (0.381)	0.110 (2.794)	24.000 (609.600)	—	NO
97-559	0.300 (7.620)	0.070 (1.778)	0.003 (0.076)	0.165 (4.191)	0.015 (0.381)	0.180 (4.572)	24.000 (609.600)	25.0 (7.6)	NO
97-560	0.500 (12.700)	0.070 (1.778)	0.003 (0.076)	0.165 (4.191)	0.015 (0.381)	0.190 (4.826)	24.000 (609.600)	25.0 (7.6)	NO
97-561	0.500 (12.700)	0.070 (1.778)	0.003 (0.076)	0.165 (4.191)	0.015 (0.381)	0.190 (4.826)	24.000 (609.600)	25.0 (7.6)	YES
97-567	0.725 (18.415)	0.209 (5.309)	0.003 (0.076)	0.500 (12.700)	0.015 (0.381)	0.408 (10.363)	24.000 (609.600)	25.0 (7.6)	NO
97-569	0.500 (12.700)	0.120 (3.048)	0.003 (0.076)	0.250 (6.350)	0.015 (0.381)	0.250 (6.350)	24.000 (609.600)	25.0 (7.6)	NO

## DIVIDER EDGE SHIELDING

Laird offers the Divider Edge Shield, the latest addition to its line of longitudinal shielding and grounding products. The Divider Edge Shield is designed to accommodate the industry's trend toward miniaturization and reduced compression forces.

- Designed to be applied to the top edge of multi-compartmental castings with wall thickness from 0.035 in. (0.889 mm) to 0.055 in. (1.397 mm)
- Clip-on design allows for easy installation and secure retention
- Unique finger design provides extremely low compression force
- Excellent shielding and grounding properties
- Provided in standard 12.000 in. (304.800 mm) lengths, or easily cut to your desired length. Longer lengths available upon request.
- 97-654 is available with "D" Lance option

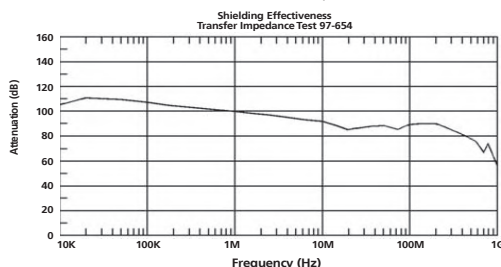
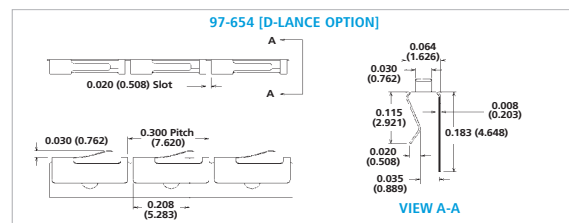
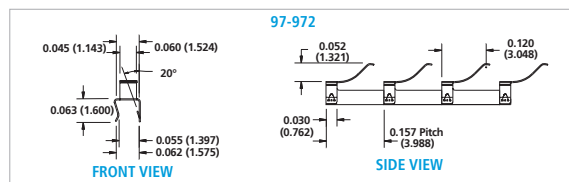
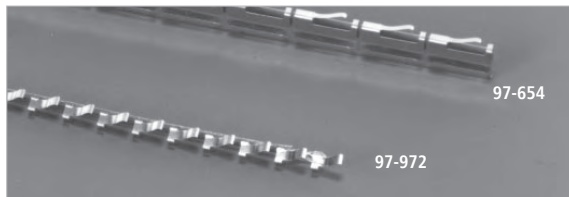

# FINGERSTOCK CARD GUIDE CLIP-ON

Laird introduces the Card Guide Clip-On, which offers excellent grounding contact from the PC board to a card guide on a rack. The unique snap-in feature of the contact finger prevents any potential snagging. This allows for bi-directional sliding contact. The Card Guide Clip-On gasket installs to the edge of the board and makes contact with ground trace on the card. The card then slides into the card guide on the rack. Low compression forces allow for easy installation of the card.

- Easily installs onto PC board
- Provides for bi-directional wiping that eliminates snagging
- Ideal, inexpensive solution for grounding applications
- High-performance beryllium copper can be plated with a wide variety of finishes for galvanic compatibility, see page 17
- Designed for board thicknesses of 0.085 in. to 0.100 in. (2.159 mm to 2.540 mm)
- Design capabilities available to handle other board thicknesses and custom applications
- 97-983 is available with "D" Lance option

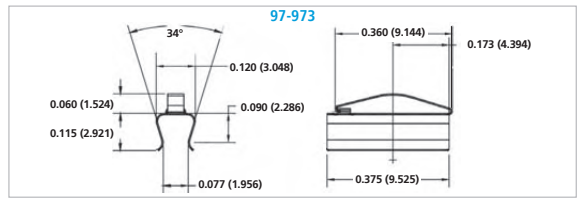
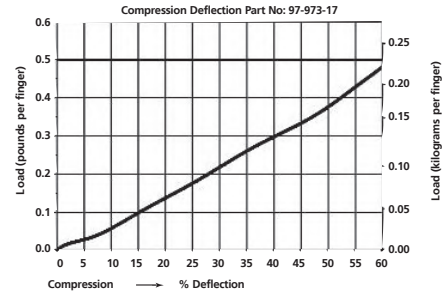
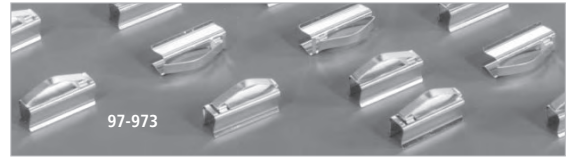

All dimensions shown are in inches (millimeters) unless otherwise specified.

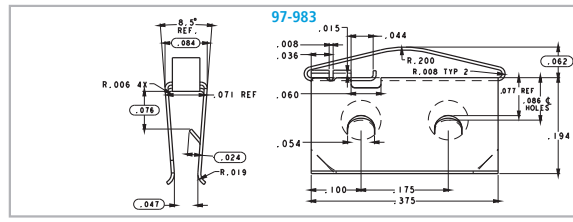

## CLIP-ON PERPENDICULAR SHIELDING

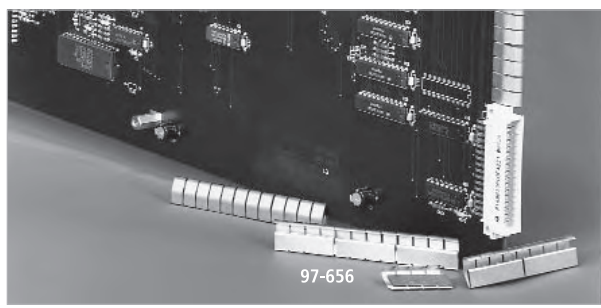

This product offers a clip-on design that permits shielding to a perpendicular surface.

- Finger design allows for continuous contact across the length of the strip
- Clip-on design is ideal where high temperature or other design considerations preclude the use of adhesive-mounted gasketing
- "D" lance design provides excellent retention of gasket and allows for a strong omnidirectional grip
- Supplied in a wide variety of plating finishes, see page 17
- Shielding effectiveness of > 80 dB for a 10 MHz plane wave.
- These 97-Series products are also available in UltraSoft® low compression force 98-Series.

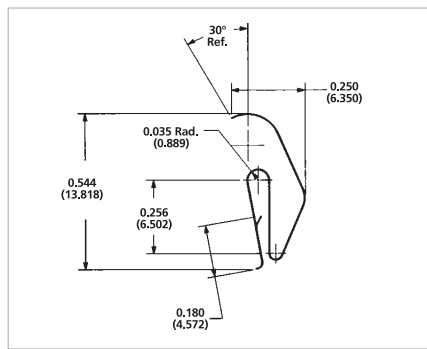
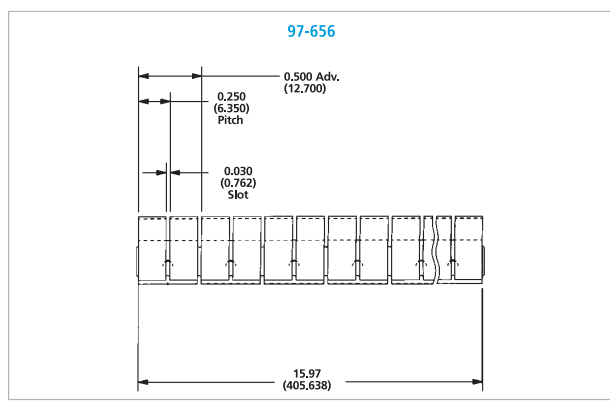

# FINGERSTOCK

## CLIP-ON PERPENDICULAR GROUNDING STRIP

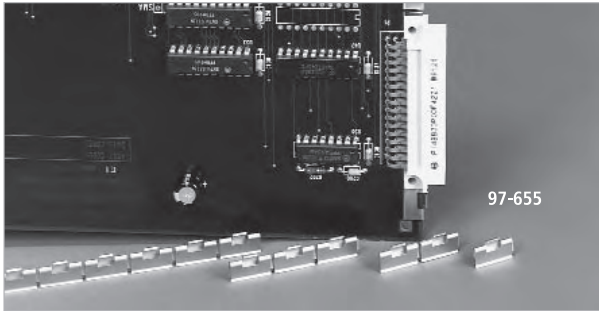

Laird offers the first clip-on design which allows grounding to occur between perpendicular surfaces.

- Unique finger extension provides grounding from card or motherboard to a backplane housing
- Finger height provides wide operating range
- Wide clip-on area with "D" lance gives additional reliable retention
- Available in strip lengths up to 12,000 in. (304,800 mm)
- Available in a wide variety of plating finishes, see page 17.

These 97-Series products are also available in UltraSoft® , 98-Series.

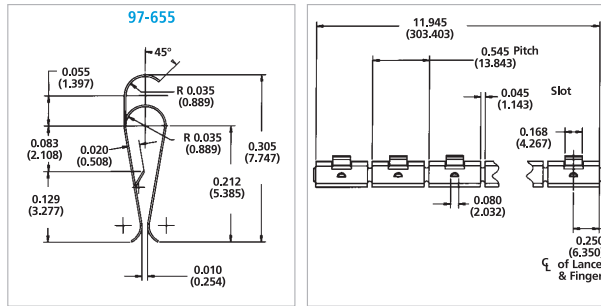
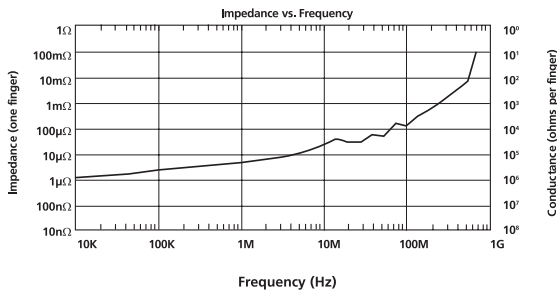

All dimensions shown are in inches (millimeters) unless otherwise specified.

## CLIP-ON LONGITUDINAL GROUNDING STRIP

The Clip-On Longitudinal Grounding Strip combines finger compression with the direction of motion in the longitudinal axis.

- Ideal for use with rack-mounted, sliding door and slide drawer assemblies
- Clip-on mounting combines ease of installation with impressive retention strength
- Designed to function in bi-directional wiping
- Asymmetrical finger design with shallow angle provides for bi-directional engagement
- Available in a wide variety of plating finishes, see page 17
- Supplied in standard lengths of 17,000 in. (431,800 mm)

Available in UltraSoft® low compression version (98-976).

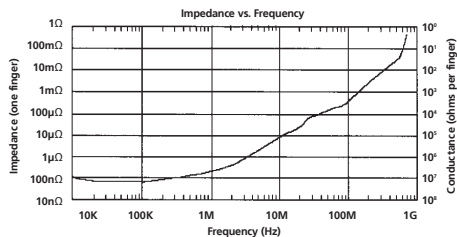
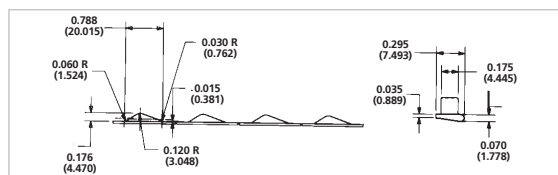
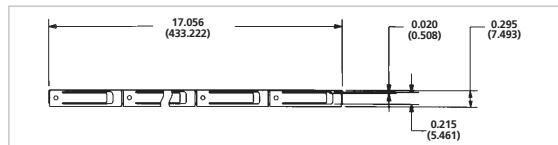



# FINGERSTOCK

## MINI-LONGITUDINAL GROUNDING GASKET

The Mini-Longitudinal Grounding Gasket is designed to accommodate small applications which often require lower compression forces.

- Allows a longitudinal sliding motion over the length of the gasket
- Ideal for rack-mounted, sliding door or side panel and drawer assemblies
- Mounting methods include conductive tapes, rivets or screws
- Miniaturized design includes extremely narrow width and low standing height
- Available in a wide variety of plated finishes, see page 17

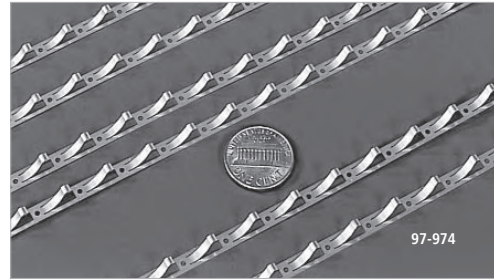

Available in UltraSoft low compression version (98-974).

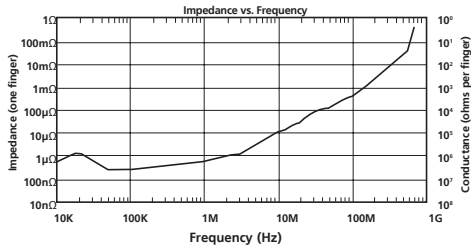

All dimensions shown are in inches (millimeters) unless otherwise specified.

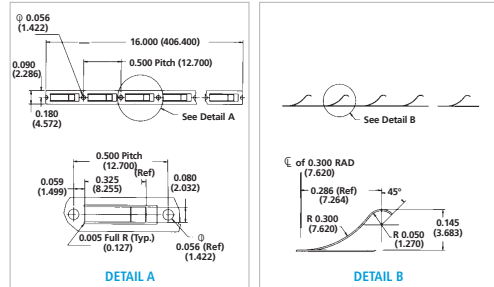

## LONGITUDINAL GROUNDING SERIES

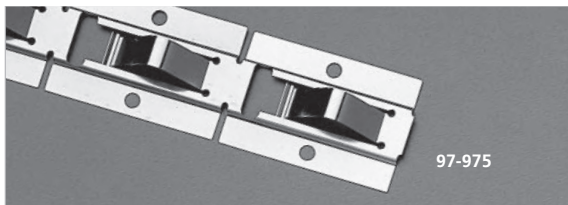

This series of beryllium copper strips combines finger compression with the direction of motion in the longitudinal axis.

- Ideal for use with rack-mounted and slide drawer assemblies
- Provides reliable and complete grounds
- Typical installation methods include hardware mounting or use of the Sticky Fingers® self-adhesive strip
- In standard finishes, see page 17

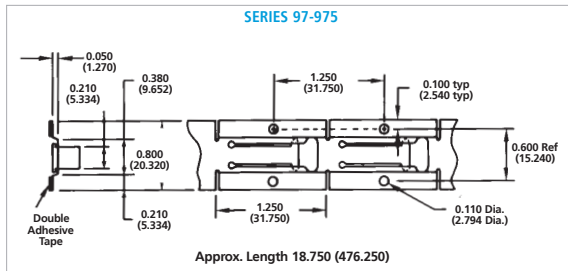

Available in UltraSoft® low compression version (98-975).

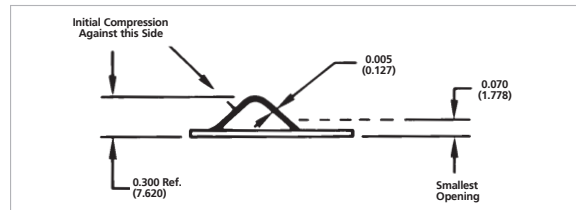

# FINGERSTOCK

## CUSTOM STAMPING

Laird's extensive product line solves hundreds of EMC problems. But each customer problem is unique. One of our standard products may not precisely meet your needs. Often a modest modification in one of our existing products will solve your problem quickly, effectively and economically.

Consider these modification possibilities:

- Special finishes
- Substitution of an alloy with differing properties
- Special lengths or coils
- Adjustment in base thicknesses
- Addition of bends, slots, holes
- Changes in width of mounting surfaces
- Removal of fingers

Let one of our application engineers show you a full range of modified standard possibilities.

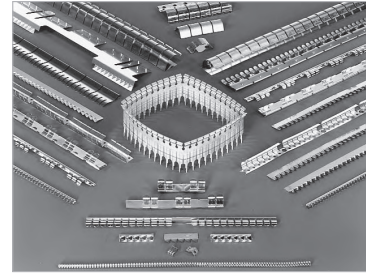

## CONTACT STRIPS / CONTACT RINGS

Contact strips are used for grounding and shielding in high-frequency equipment and for forming large diameter contact rings.

A wide variety of beryllium copper contact strips provides engineers and designers with flexibility in solving grounding and shielding problems. Various lengths, widths, thicknesses, contours and hole locations are possible for many of the standard catalog items.

The large variety of sizes and shapes of contact rings offers engineers a wide choice in meeting design requirements for microwave cavities, tuning, shielding and grounding applications. Rings are made from strip stock formed into an unclosed circle which, when assembled, becomes a complete ring.

Please reference the Fingerstock Gaskets and Metal Grounding Catalog for a complete listing of Contact Strips and Contact Rings, including part numbers and dimensions.

FEMALE RINGS



MALE RINGS

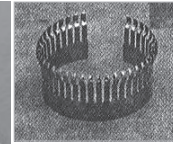

## IEEE 1394 HORIZONTAL CONNECTOR GASKET

Laird offers an addition to our connector gasket line, part number 97-787, which is designed to fit all IEEE 1394 horizontal connectors. Made from copper beryllium, these gaskets provide superior grounding and reduce emissions from the connector by providing a low-impedance grounding path from the connector shell to the faceplate.

The gasket is mounted over the top of a horizontal IEEE 1394 connector and soldered to the board. Contact with both the faceplate and the connector shell is accomplished once the board is assembled into its housing. These gaskets can be provided in trays to facilitate pick-and-place assembly onto the board and wave soldering automation.

- Accommodates a wide range of connector protrusion positions
- Fits all IEEE 1394 horizontal connectors
- Gasket can be placed onto the printed circuit board via pick-and-place
- Packaging to accommodate high-speed assembly is optional
- Simple thru-pin mounting method
- Grounds the connector to the faceplate
- Available in a variety of plating finishes



97-786

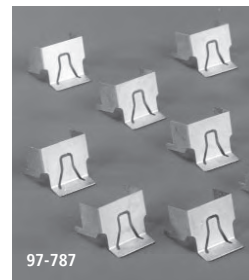

97-787

## DIN CONNECTOR SERIES

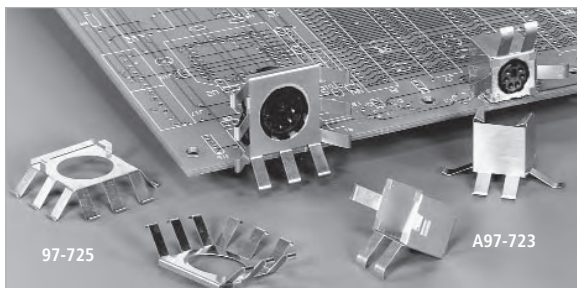

97-725

A97-723

Laird's DIN Connector Gasket Series is designed to ground connector plugs to the chassis of electronic systems. Manufactured in beryllium copper, these connector gaskets provide excellent conductivity and shielding characteristics.

- Available in two sizes to accommodate a variety of DIN connector plugs
- Large compression range between board and chassis
- Wide footprint to accommodate misalignment of plug to chassis opening
- Unique slide-on design for ease of assembly
- Grounds circuit boards, as well as keyboards and audio equipment
- Available in a wide variety of plated finishes, see page 17

# FINGERSTOCK USB CONNECTOR

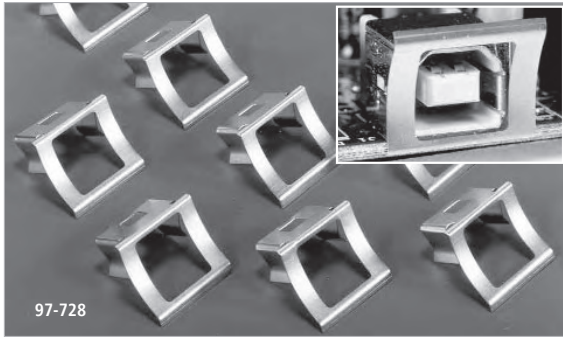

Laird offers the USB (Universal Serial Bus) Type B connector gasket. The unique design easily snaps onto the connector prior to placement on the printed circuit board and fits all Series B USB right angle connector brands. Made from high performance beryllium copper, these gaskets provide superior grounding characteristics and enhances the shielding of the connector due to the short electrical path to the ground plane provided when the gasket makes contact with the connector.

- Gasket easily snaps onto the connector for a secure fit
- Connector/gasket assembly can be placed onto the board via pick-and-place
- High clip force attaches clip to connector body for good electrical contact and secure transport prior to soldering
- Once the shielded connector assembly is soldered to the PCB, the shield is captivated between board and connector and provides reliable contact between the connector and faceplate
- Simple compact design fits within 0.625 in. X 0.625 in. (15.875 mm X 15.875 mm) windows
- Available in a variety of plated finishes

## FIBER OPTIC SHIELD

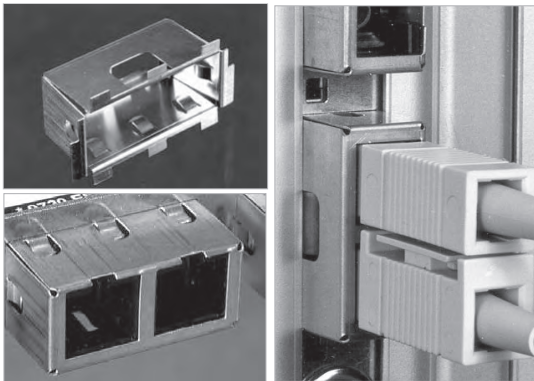

Laird provides fiber optic shielding, which provides excellent EMI shielding around the faceplate aperture which houses board mounted fiber optic transceivers. This EMI shield easily fits over the industry standard 1 x 9 style fiber optic transceiver with a duplex SC connector. The shielded transceiver is then inserted into the faceplate.

- Fits all 1 x 9 style fiber optic transceivers with duplex SC connectors
- Provides shielding around the faceplate aperture which houses board-mounted fiber optic transceivers

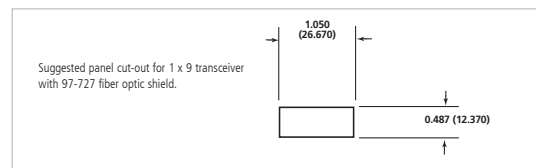

## GBIC FIBER OPTIC SHIELD

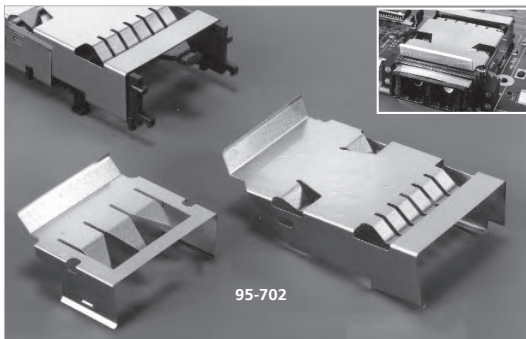

Laird offers the GBIC Shield for reducing emissions from GBIC (GigaBit Interface Converter) fiber optic transceivers. Fiber optic transceivers can be a troublesome source of EMI because they emit high-frequency signals and are located adjacent to large apertures in the enclosure. The GBIC Fiber Optic Shield assembly reduces the radiated emissions from the transceivers by conducting interference current away from the transceiver and onto the enclosure surface.

Simple assembly of the shield is accomplished by snapping the two shield halves onto an uninstalled guide rail assembly. The rail is then mounted onto the printed circuit board in the normal fashion.

Spring finger design on both halves of the GBIC shield provide grounding for both sides of a transceiver module. In addition, the bottom half fingers can provide a low impedance connection to the circuit board ground plane.

- Fits most Tyco (AMP) and Methode guide rails common to routers, switches and other network hardware
- Requires no extra mounting holes or solder
- Provided in stainless steel for high galvanic compatibility
- Simple snap-on assembly

### HOW TO ORDER:

To obtain the two piece assembly, order part number 95-702.

# FINGERSTOCK

## "D" CONNECTOR SHIELDING/SLOTTED "D"

### "D" CONNECTOR SHIELDING

Laird offers the "D" Connector Shield Series for grounding and shielding of D Subminiature Connectors. This series is designed to fit most commonly used 9 pin through 68 pin connectors.

- Available in stainless steel and beryllium copper, conductive elastomers, oriented wire and other materials
- Improved 20 degree angle flange design on metal connectors:
  - provides continuous contact for increased shielding effectiveness
  - fills gaps and adjusts for irregularities in the flatness of the mounting surface
- Beryllium copper parts available in UltraSoft® low force version and available in a wide variety of finishes, see page 17
- Custom shapes and designs also available
- Versatile front or rear mounting

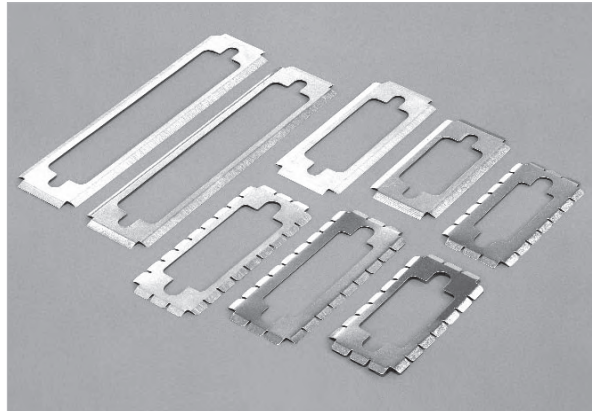

### SLOTTED "D" CONNECTOR SHIELDING

The slotted D connector gaskets provide shielding for most 9 through 50 pin connectors. The separate finger design provides maximum surface contact, provides high shielding effectiveness and low compression forces.

Slotted D connector gaskets are available from stock in copper beryllium and stainless steel. Copper beryllium parts can be plated to a variety of finishes for galvanic compatibility, see page 17.

### "D" CONNECTOR SERIES DIMENSIONS FOR BeCu AND STAINLESS STEEL

SS	BeCu	# PINS	A	B	C	D	E	F	G
97-768	97-778	9	1.410 (35.814)	0.980 (24.892)	0.780 (19.812)	0.220 (5.588)	0.440 (11.176)	0.690 (17.526)	0.130 (3.302)
97-769	97-779	15	1.740 (44.196)	1.310 (33.274)	1.110 (28.194)	0.220 (5.588)	0.440 (11.176)	0.690 (17.526)	0.130 (3.302)
97-770	97-780	25	2.280 (57.912)	1.850 (46.990)	1.650 (41.910)	0.220 (5.588)	0.440 (11.176)	0.690 (17.526)	0.130 (3.302)
97-771	97-781	37	2.930 (74.422)	2.500 (63.500)	2.290 (58.166)	0.220 (5.588)	0.440 (11.176)	0.690 (17.526)	0.130 (3.302)
97-772	97-782	50	2.840 (72.136)	2.410 (61.214)	2.110 (53.594)	0.280 (7.112)	0.550 (13.970)	0.800 (20.320)	0.240 (6.096)
97-773	97-783	68	1.800 (45.720)	1.480 (37.592)	1.260 (32.004)	0.080 (2.032)	0.160 (4.064)	0.400 (10.160)	0.090 (2.286)

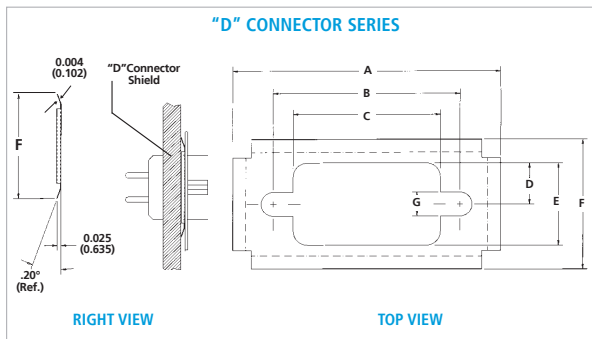

### SLOTTED "D" CONNECTOR SHIELDING

SS	BeCu	# Pins	A	B	C	D	E	F	G	Pitch
95-822	97-822	9	1.412 (35.865)	0.984 (24.994)	0.784 (19.914)	0.220 (5.588)	0.440 (11.176)	0.690 (17.526)	0.160 (4.064)	0.718 (18.241)
95-823	97-823	9	1.412 (35.865)	0.984 (24.994)	0.784 (19.914)	0.180 (4.572)	0.360 (9.144)	0.690 (17.526)	0.160 (4.064)	0.178 (4.521)
95-825	97-825	15	1.740 (44.196)	1.312 (33.325)	1.112 (28.245)	0.180 (4.572)	0.360 (9.144)	0.690 (17.526)	0.160 (4.064)	0.175 (4.445)
95-824	97-824	15	1.740 (44.196)	1.312 (33.325)	1.112 (28.245)	0.220 (5.588)	0.360 (9.144)	0.690 (17.526)	0.160 (4.064)	0.175 (4.445)
95-827	97-827	25	2.280 (57.912)	1.852 (47.041)	1.652 (41.960)	0.180 (4.572)	0.360 (9.144)	0.690 (17.526)	0.160 (4.064)	0.174 (4.420)
95-826	97-826	25	2.280 (57.912)	1.852 (47.041)	1.652 (41.960)	0.220 (5.588)	0.440 (11.176)	0.690 (17.526)	0.160 (4.064)	0.174 (4.420)
95-828	97-828	37	2.298 (58.369)	2.500 (63.500)	2.290 (58.166)	0.220 (5.588)	0.440 (11.176)	0.690 (17.526)	0.160 (4.064)	0.184 (4.674)

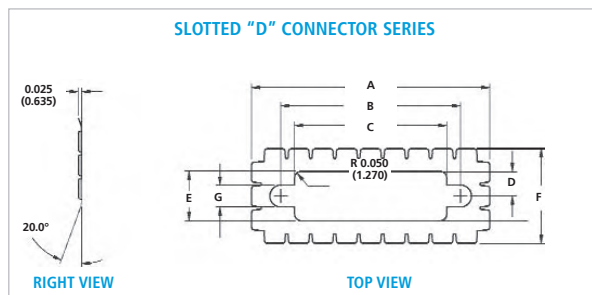

# PRECISION STAMPED METALS

## STANDARD PRECISION CONTACTS

### STANDARD PRECISION ELECTRONIC CONTACTS

Laird standard precision electronic contacts ground, carry current and signals, and interconnect boards and devices. A wide variety of plating options allow for the maximum electrical current carrying performance. An array of designs in a standard format are ready for production. Installed costs are lower with our tape and reel.

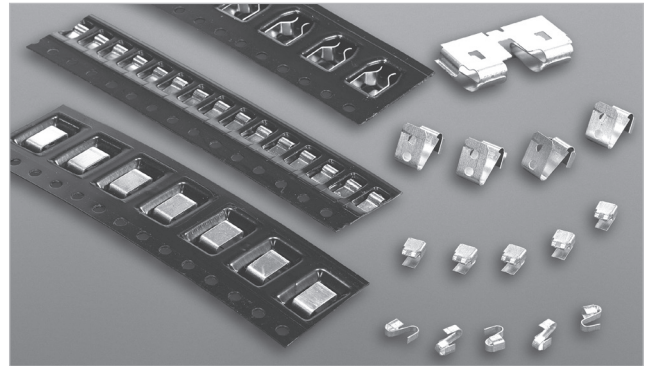
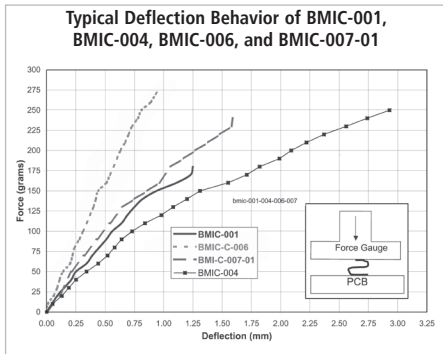

## SMD CONTACTS

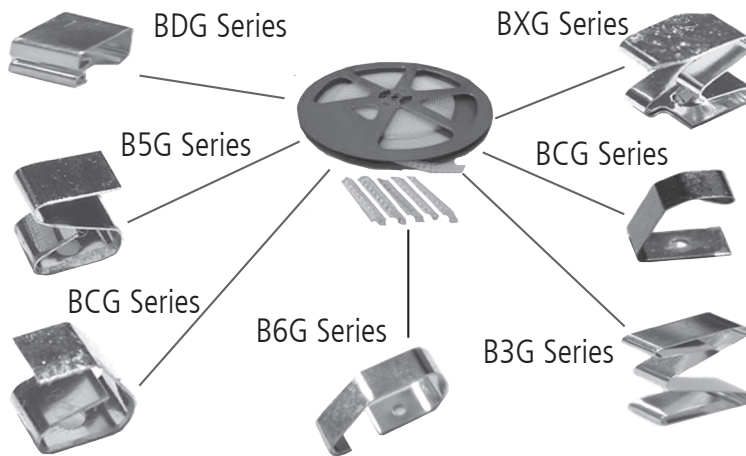

### Part Numbering



- 1 material code      B:BeCu   T:TiCu   S:stainless   P:Phosphor Bronze
- 2 shape code        C-type   5-type   D-type   3-type
- 3 electroplate code   G:Au   S:Sn   N:Ni   A:Ag
- 4 size code (width)   □□ → □.□mm   ex. 25 → 2.5 mm
- 5 size code (length)   □□ → □.□mm   ex. 40 → 4.0 mm
- 6 size code (high)   □□□ → □□.□mm   ex. 100 → 10.0 mm

example: BCG-20x30x040

# PRECISION STAMPED METALS

## STANDARD PRECISION CONTACTS

### STANDARD PRECISION ELECTRONIC CONTACTS

PART NUMBER	MATERIAL	AVAILABLE PLATINGS	TYPICAL APPLICATIONS	PARTS PER REEL
BMI-C-001	0,10 mm BeCu	Gold	Grounding, energy carrying	3000
BMI-C-001-SN	0,10 mm BeCu	Tin	Grounding, energy carrying	3000

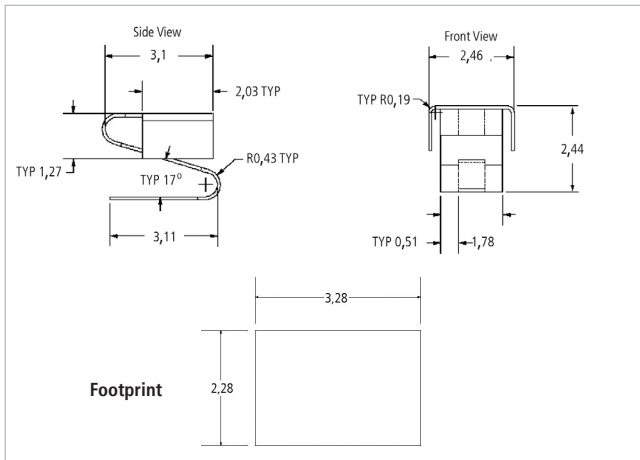

### STANDARD PRECISION ELECTRONIC CONTACTS

CONTACTS	MATERIAL	AVAILABLE PLATINGS	TYPICAL APPLICATIONS	PARTS PER REEL
BMI-C-002	0,10 mm BeCu	Gold	Grounding, energy carrying	3500

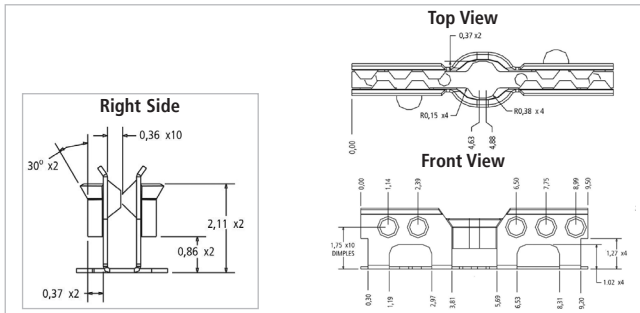

### PART NO. BMI-C-006

PART NUMBER	MATERIAL	AVAILABLE PLATINGS	TYPICAL APPLICATIONS	PARTS PER REEL
BMI-C-006	0,10 mm BeCu	Tin	Grounding, energy carrying	3500

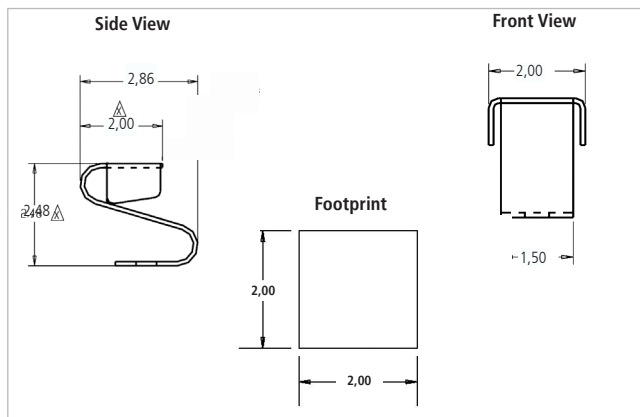

### STANDARD PRECISION ELECTRONIC CONTACTS MATERIAL VARIATIONS

PART NUMBER	MATERIAL	AVAILABLE PLATINGS	TYPICAL APPLICATIONS	PARTS PER REEL
BMI-C-001	0,10 mm BeCu	Gold	Grounding, energy carrying	3000
BMI-C-001-SN	0,10 mm BeCu	Tin	Grounding, energy carrying	3000
BMI-C-002	0,10 mm BeCu	Gold	Grounding, energy carrying	3500
BMI-C-004	0,10 mm BeCu	Gold	Grounding, energy carrying	1400
BMI-C-004-SN	0,10 mm BeCu	Tin	Grounding, energy carrying	1400
BMI-C-006	0,10 mm BeCu	Tin	Grounding, energy carrying	3500
BMI-C-007-01	0,13 mm BeCu	Tin	Grounding, energy carrying	2300
BMI-C-010-*	0,20 mm Spring Steel	Tin	Standoff, support	3500 (Var)

Material properties are for reference only. Product testing by purchaser is recommended to confirm. Laird assumes no liability for product failure unless specifically stated in writing.

### STANDARD PRECISION ELECTRONIC CONTACTS

PART NUMBER	MATERIAL	AVAILABLE PLATINGS	TYPICAL APPLICATIONS	PARTS PER REEL
BMI-C-004	0,10 mm BeCu	Gold	Grounding, energy carrying	1400
BMI-C-004-SN	0,10 mm BeCu	Tin	Grounding, energy carrying	1400

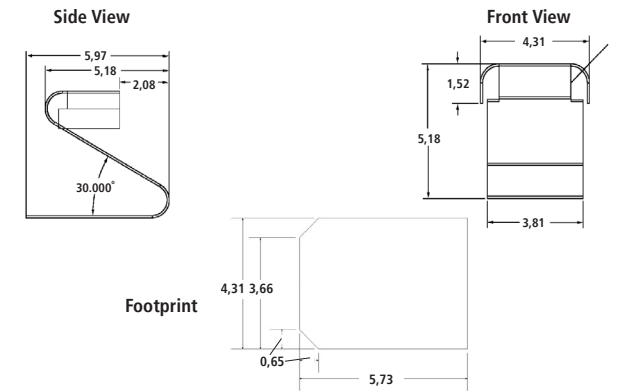

### PART NO. BMI-C-007-01

PART NUMBER	MATERIAL	AVAILABLE PLATINGS	TYPICAL APPLICATIONS	PARTS PER REEL
BMI-C-007-01	0,13 mm BeCu	Tin	Grounding, energy carrying	2300

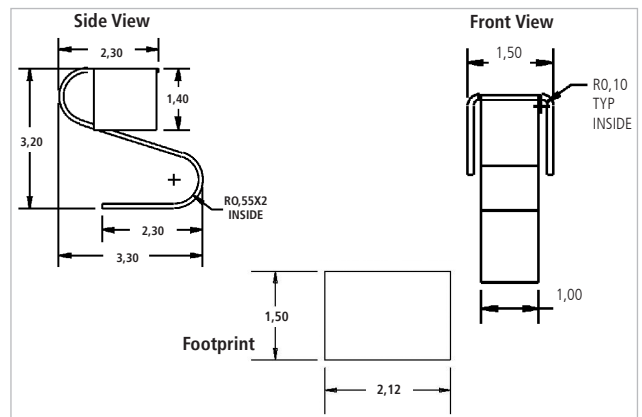

# PRECISION STAMPED METALS

## CUSTOM DESIGN

### CUSTOM PRECISION ELECTRONIC CONTACTS

#### GAIN MAXIMUM ELECTRICAL AND CARRYING PERFORMANCE

From concept to placement, Laird has the expertise to deliver custom precision surface mount contacts. Using the latest computer simulation techniques, Laird provides properly designed contacts that ground, carry current and signals, and interconnect boards and devices. Laird uses basic geometric parameters (length, width, uncompressed height, compressed height, contact force) to conduct Finite Element Analysis (FEA) on your prospective design. With the FEA results, we can then identify the best design to optimize a product's operational performance. Features are incorporated to provide for placement and soldering of the contact onto the circuit board.

Laird offers a wide range of plating options to allow for maximum electrical current carrying performance.

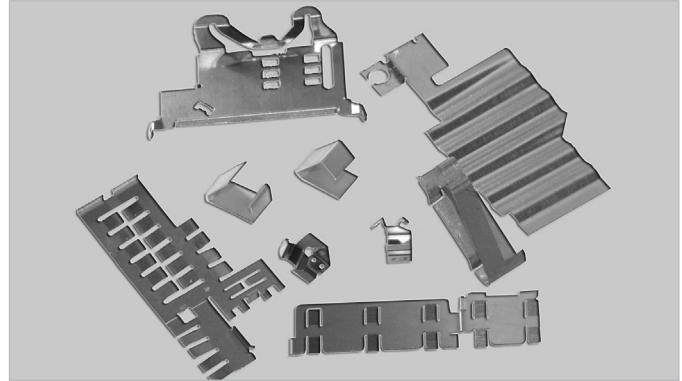

Automated packaging allows for complex and small designs with lower installed costs.

Contact base materials include beryllium copper, phosphor bronze, nickel and stainless steel. All contacts are fully solderable as required.

### CUSTOM PRECISION ELECTRONIC CONTACTS MATERIAL VARIATIONS

TYPE	THICKNESS in (mm)	HEAT TREATMENT	PLATING/COATING	COMMENTS
Beryllium Copper Alloys: 17200, 190, 290, 174	.0035 to .080 (0,089 to 2,03)	Heat Treatable	Tin, nickel, gold, silver	Heat Treated as necessary Pre-Plated or Post Plated
Phosphor Bronze Alloys: 510, 505, 511, 521, 544	.004 to .090 (0,10 to 2,29)	N/A	Tin, nickel, gold, silver	Pre-Plated or Post Plated
Copper Alloys: 110, 102, 122, 1093	.006 to .125 (0,15 to 3,18)	N/A	Tin, nickel, gold, silver	Pre-Plated or Post Plated
Brass Alloys: 260, 210, 220, 226, 230, 240, 268, 350, 353	.004 to .090 (0,10 to 2,29)	N/A	Tin, nickel, gold, silver	Pre-Plated or Post Plated
Nickel Silver Alloys: 770, 752, 762	.004 to 0.060 (0,10 to 1,52)	N/A	Tin, nickel, gold, silver	Solderable in unplated condition (if used with LT proprietary process)
Stainless Steel Alloys: 301, 302, 305, 316, 201, 202	.004 to .090 (0,10 to 2,29)	N/A	Tin, gold	Pre-Plated or Post Plated
Stainless Steel Alloys: 410, 420	.004 to .090 (0,10 to 2,29)	Heat Treatable	Tin, gold	Heat Treated as necessary Pre-Plated or Post Plated
Special Alloys: Clad metals	.0035 to .080 (0,089 to 2,03)	N/A	Tin, nickel, gold, silver	Pre-Plated or Post Plated

Additional material choices are available upon request. Material properties are for reference only. Product testing by purchaser is recommended to confirm. Laird assumes no liability for product failure unless specifically stated in writing.

# PRECISION STAMPED METALS

## CUSTOM STAMPING

Our CAD helps you fine-tune your initial designs. Our finite element analysis (FEA) simulates the performance of that design under actual working conditions. Our CNC equipment helps produce precisely fabricated samples. Our optical gauging inspection system ensures that the latest measurement technology is used to measure your parts. Computer-programmable high-speed Bruderer punch presses enable our progressive dies to produce families of parts economically by eliminating the need for costly multiple dies. The result: Laird can meet your custom stamping needs with the shortest, most reliable lead times in the industry.

### SHORT RUNS A SPECIALTY

With Laird you get complete prototype and low volume expertise. Our capabilities range from photo-etching and secondary stamping to an extensive selection of universal tooling and short-run production systems.

### LAIRD DOES IT ALL

We provide full in-house tool and die design and manufacturing capabilities including CAD, CAM and the high-precision tolerances of wire EDM. We manufacture custom components for many products, including connectors, switches, and electronic and electromechanical assemblies. Platings – from gold to zinc – are also a part of our capabilities. No wonder some of the world's leading electronics, aerospace, automotive and instrumentation companies turn to Laird for custom-engineered stampings. For more information on custom products, contact Laird's sales department.

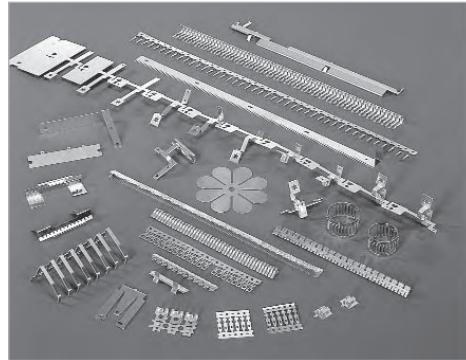

## CUSTOM ASSEMBLIES

Many of the world's leading manufacturers of high technology products turn to Laird for their custom assembly requirements. Critical lead time and inspection criteria are ensured by SPC quality control during both stamping and assembly operations.

### CAPABILITIES:

- Fully automated or semiautomated equipment
- Heat staking
- Ultrasonic welding
- Resistance welding
- Conventional and orbital riveting
- MIL certification soldering
- Critical/intricate requirements performed
- Special packaging for pick-and-place

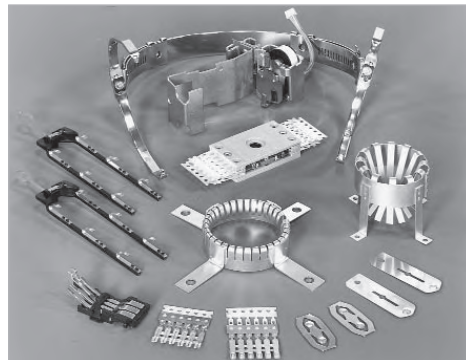

## MULTISLIDE CAPABILITIES

MultiSlide fabrication provides high volume production quantities with low-cost tooling. A variety of part configurations can be designed for this economic process. In-house tooling design and manufacturing help reduce lead times.

### ADVANTAGES:

- Reduced material consumption
- Variations in materials are available from wire to flat strips
- Fully automated production
- Tooling can be easily reworked to accommodate moderate changes
- Form stations are independently adjustable for part consistency
- Interchangeability of tools
- Economic fabrication of RF board level shields

For more information on custom products, contact Laird Technologies' sales department.

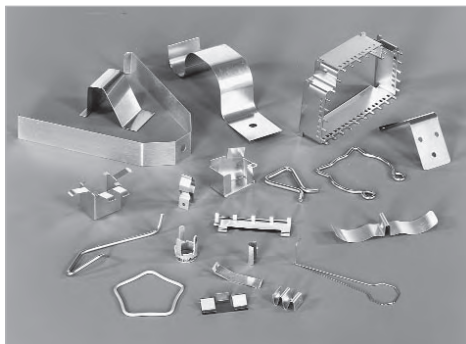



# METALS GALVANIC COMPATIBILITY CHART

For harsh environments (presence of fair to good ionic conductors), all metals in contact with each other should be no more than one level of the chart apart to minimize corrosion. This is shown by the dark blue regions of the plating bar chart under specific platings. Outdoor applications, high humidity and salt air fall into this category.

For normal environments (storage in warehouses or non-temperature/humidity-controlled environments, etc.), the difference between dissimilar metals should not exceed 0.25 volts (5 chart levels counting the origin). This is shown by the light blue regions of the chart under specific platings.

For office environments (temperature and humidity controlled), 0.5 volts can be tolerated (10 chart levels counting the origin). This is shown by the dark gray regions under specific platings. Caution should be maintained when deciding that your application is temperature and humidity controlled. Many devices intended for use in office environments are stored in warehouses for extended periods of time before and in between use.

These are general guidelines which apply under most circumstances, but corrosion is a very complex subject whose details could not possibly fit in this space. If you are not sure which metals are compatible, please feel free to contact Laird and talk to our corrosion experts.

GROUP NUMBER	COMMON METAL SURFACES METALLURGICAL CATEGORY	ANODIC INDEX, V
1	Gold; Au-Pt alloys; wrought platinum; graphite carbon	0.00
2		0.05
3	Rhodium plating	0.10
4	Silver; high-silver alloys	0.15
5		0.20
6		0.25
7	Nickel; nickel-copper alloys; titanium, titanium alloys; Monel	0.30
8	Beryllium copper; low brasses or bronzes; silver solder; copper; Ni-Cr alloys; austenitic corrosion-resistant steels; most chrome-moly steels; specialty high-temp stainless steels	0.35
9	Commercial yellow brasses and bronzes	0.40
10	High brasses and bronzes; naval brass; Muntz metal	0.45
11	18% Cr type corrosion resistant steels; common 300 series stainless steels	0.50
12		0.55
13	Chromium or tin plating; 12% Cr type corrosion resistant steels; most 400 series stainless steels, i.e., 410 and some cast stainless steels	0.60
14	Terneplate; tin-lead solder	0.65
15	Lead; high-lead alloys	0.70
16	Wrought 2000 series aluminum alloys	0.75
17		0.80
18	Wrought gray or malleable iron; plain carbon and low-alloy steels; armco iron; cold-rolled steel	0.85
19	Wrought aluminum alloys except 2000 series cast Al-Si alloys; 6000 series aluminum	0.90
20	Cast aluminum alloys other than Al-Si; cadmium plating	0.95
21		1.00
22		1.05
23		1.10
24		1.15
25	Hot-dip galvanized or electrogalvanized steel	1.20
26	Wrought zinc; zinc die casting alloys	1.25
27		1.30
28		1.35
29		1.40
30		1.45
31		1.50
32		1.55
33		1.60
34		1.65
35		1.70
36	Wrought and cast magnesium alloys	1.75
37		1.80
38	Beryllium	1.85

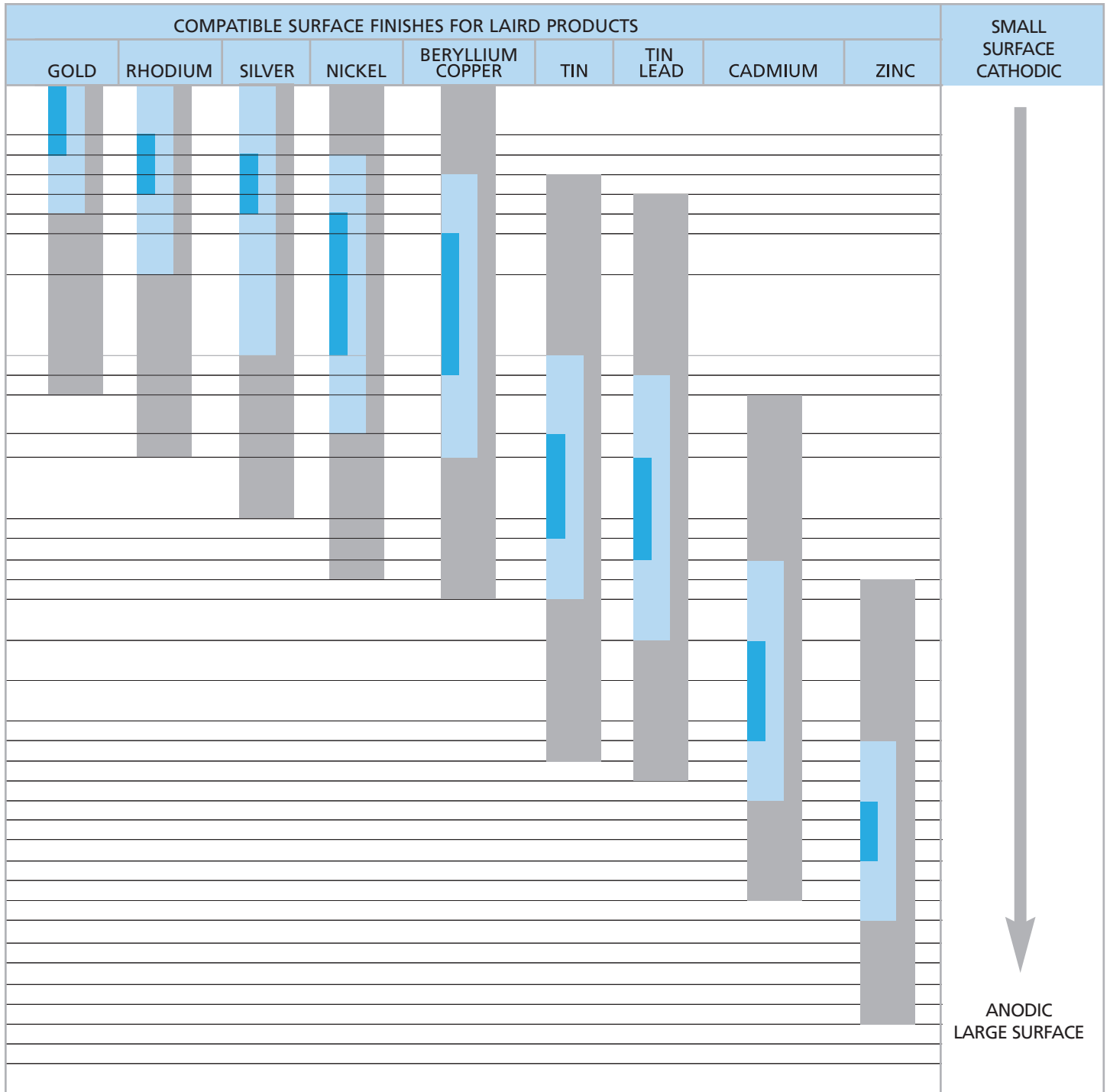

# VENT PANELS

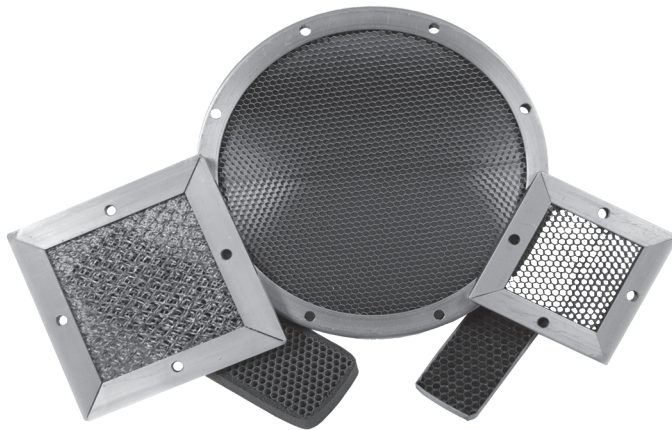

Laird has various vent panels to fit specific application needs.

Laird shielding ventilation panels are available in a wide array of materials, platings and mounting configurations.

Vent panels offer designers new versatility to meet EMI, environmental and mechanical system requirements.

When custom designs are needed, Laird engineering staff helps construct efficiencies in performance, cost and manufacturability from the very beginning stages of the application.

# VENT PANELS

## MAXAIR™

### COMBINING EMI INNOVATION AND COST EFFICIENCY

Laird's patented MaxAir vent panel product line provides an innovative cost effective approach for providing increased airflow and EMI protection for telecommunications hardware equipment such as fans and server racks.

This metallized polycarbonate honeycomb material provides a rigid medium eliminating the need for costly frame designs. This frameless design allows greater airflow through the entire honeycomb surface and ease of installation through its press-to-fit assembly. The MaxAir vent panel provides greater durability and flexibility than traditional aluminum vent panels.

Varying densities of material are available to meet specific levels of rigidity requirements. The honeycomb cell size can be 0.125 in (3,18mm) or 0.250 in (6,35mm) in standard thicknesses of 0.250 in (6,35mm) and 0.500 in (12,70mm).

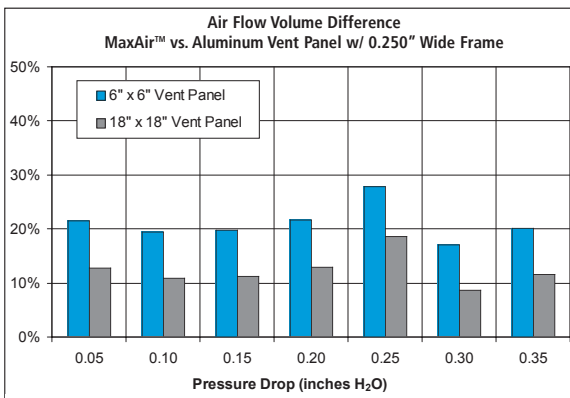
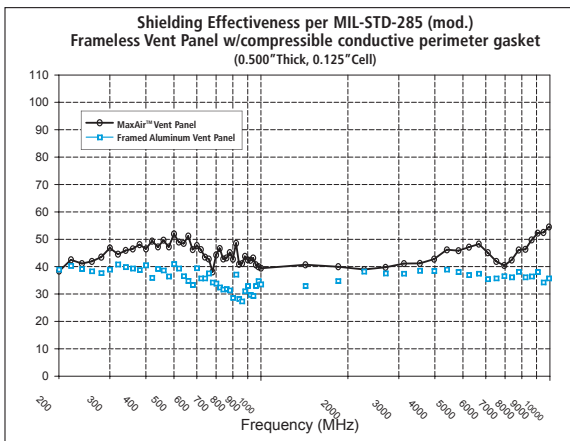
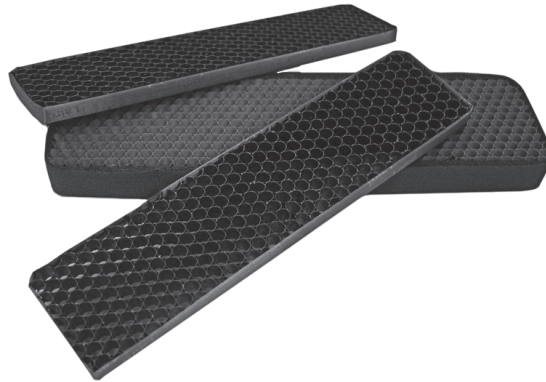

### Features and Benefits:

- Metallized polymeric honeycomb provides excellent product rigidity and dent resistance
- Eliminates frames, rivets and costly labor to install
- UL 94 V0 rated or intumescent coated versions available for flame resistance
- Increases useable air flow area by 10% to 20% compared to framed aluminum vent panels
- Special features can be machined into honeycomb, such as recesses and rabbet cuts to customize panel
- Half the weight of traditional aluminum honeycomb vent panels
- Compressible conductive perimeter gasket provides extensive tolerance to accommodate variations in shelf widths or vent panel opening dimensions
- Can be manually inserted with slide-in motion or by compression fit utilizing compression stops and minimal hardware

### APPLICATIONS:

- Telecommunications hardware equipment
- Fans
- Server racks
- Military applications
- Shielded rooms

# VENT PANELS

## ELECTRO-AIR™ EMI/DUST FILTRATION PANEL

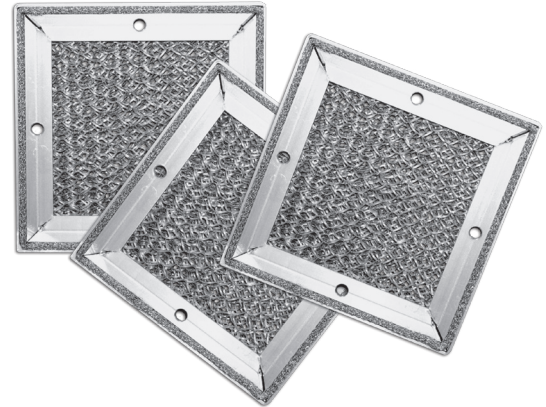

### Maximum Protection/Minimum Impedance

Laird has a proven solution for air filtration and EMI shielding in electronic enclosures. The Electro-Air EMI/dust filtration panel, consisting of layered, woven, and crimped wire mesh plus filtering media (as needed), captures microscopic airborne contaminants while providing minimal air flow impedance.

Better yet, the panel's specially designed EMI gasket prevents signal migration to the enclosed sensitive electronic equipment. In fact, when measured according to MIL-STD-285, the panel provides shielding effectiveness in excess of 60 dB for a range of 18 MHz to 1 GHz plane wave.

#### Features and Benefits:

- Universal applications—ideal for small enclosures, large housings, high traffic areas, even room size facilities
- Extensive service life—built to outlast the equipment it protects
- Variety of design specifications—modular construction is available in assorted standard sizes from 3 to 18 sq. in. (19,35 to 116,13 sq. cm)
- Easy installation—pre-drilled through holes or captive fasteners allow for quick mounting and removal
- Simple maintenance—washing with mild soap solution, rinsing, and drying as often as necessary does not degrade performance
- Design assistance—Laird Technologies engineering department offers technical assistance and testing data to help solve the toughest application challenges

#### METAL AND PLATING CODES

CODE NO	FRAME MATERIAL	FILTER MEDIA	EMI GASKET	PLATING FINISH
73	Aluminum Alloy 6063-T4	<b>GRILLE:</b> Aluminum Alloy 6063-T4 <b>MEDIA:</b> Wire Fabric Aluminum RR-W-385 Type VII 18x14	<b>GROUND:</b> Knit Monel Wire Per QQ-N-281 Class A <b>ELASTOMER:</b> Neoprene Sponge MIL-R-6130 Type II Medium	Chromate Coating Per MIL-C-5541 Class 3
74	Aluminum Alloy 6063-T4	Aluminum Alloy 1100-0 Per QQ-A-250/1, with Polyethylene Interlayer	Knit Monel Wire Per QQ-N-281 Class A	Chromate Coating Per MIL-C-5541 Class 3

*If required, the panels can be supplied painted to match enclosure color.*

#### AIR FLOW VS. RESISTANCE

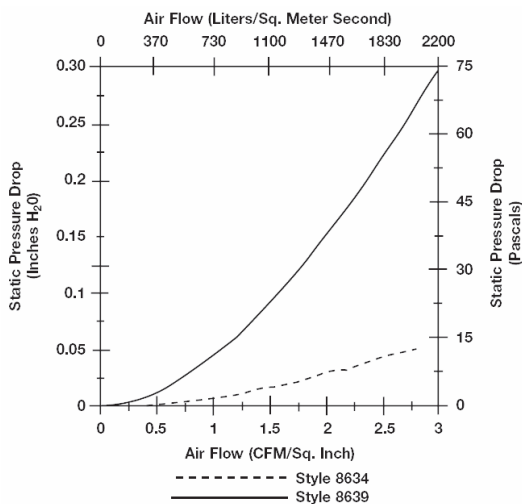

#### SHIELDING EFFECTIVENESS

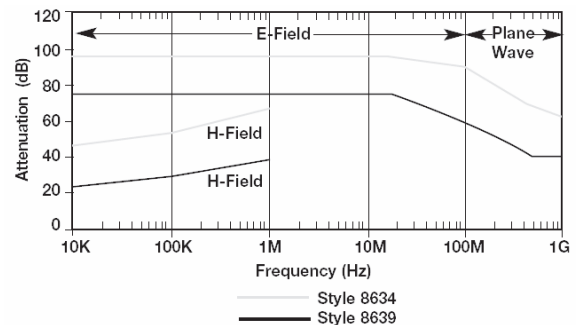

#### FILTRATION PANEL SIZE DETERMINATION STYLE 8639

1. Customer determines fan size and velocity based on their calculated cooling requirements. Example: Fan @ 240 CFM velocity with static pressure of 0.035 inches H<sub>2</sub>O.
2. Determine panel opening size so not to impede airflow
  - A. From Air Flow vs. Resistance graph intersect 0.035 inches on Y axis
  - B. Draw line to curve—this intersects at 2.3 CFM/in<sup>2</sup>
  - C. Required vent opening = (240 ÷ 2.3) = 104 in<sup>2</sup> opening
  - D. Choose vent size with 104 in<sup>2</sup> opening or larger

For additional information on any of the other products available, please contact sales for assistance or visit us at [www.lairdtech.com](http://www.lairdtech.com).

# VENT PANELS ELECTROVENT™

Laird offers ElectroVent EMI shielding ventilation panels. Available in a wide choice of materials, platings, and mounting configurations, ElectroVent offers the designer new versatility to meet EMI, environmental and mechanical system requirements.

## AVAILABLE PROTECTIVE GRILLE

For high traffic areas, all EMI ventilation panels are available with grille installed to protect honeycomb from damage that could impede airflow or shielding effectiveness.

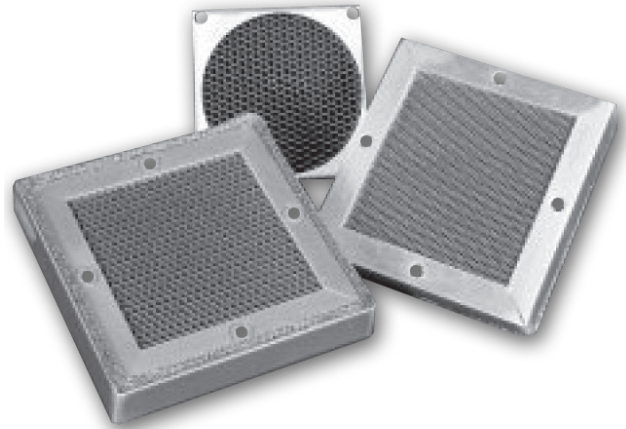

Vent panels range from 3 in. (76,2 mm) to 18 in. (457,2 mm) square in standard sizes, and can be ordered with either 0.50 in. (12,7 mm) thick or space-saving 0.25 in. (6,4 mm) thick honeycombs.

### Features and Benefits:

- Wide choice of materials and finishes to meet a broad range of shielding effectiveness requirements
- Varied mounting configurations to meet environmental and space considerations
- Protective grille can be supplied
- Panel supplied with 0.25 in (6,4 mm) thick or 0.50 in (12,7 mm) thick honeycomb
- Full EMI test of panel to MIL-STD-285 to aid in the early stages of equipment panel design

TABLE 1. CODES FOR PANEL MATERIALS AND PLATING COMBINATIONS

CODE NO.	HONEYCOMB MATERIALS	FRAME MATERIALS	PLATING	EMI GASKET
70	Aluminum Alloy MIL-C-7438	Aluminum Alloy 6063-T4	Chromate Coating MIL-C-5541 Class 3	Wire Knit: Monel QQ-N-281 Class A Elastomer: Neoprene MIL-R-6130 Type Grade A Medium
71	Aluminum Alloy MIL-C-7438	Aluminum Alloy 6063-T4	Tin Plating MIL-T-10727 Type 1	Wire Knit: Tin Coated Copper Clad Steel ASTM B 520 Elastomer: Neoprene MIL-R-6130 Type Grade A Medium
72	Steel SAE 1010	Aluminum Alloy 6063-T4* Chromate Coating	Honeycomb only Tin Plate MIL-T-10727 Type 1	Wire Knit: Monel QQ-N-281 Class A Elastomer: Neoprene MIL-R-6130 Type Grade A Medium

\*Available with tin plated steel frame if required.

## VENT PANEL SIZE DETERMINATION

1. Customer determines fan size and velocity based on their calculated cooling requirements. Example: Fan @ 240 CFM velocity with static pressure of 0.035 inches H<sub>2</sub>O.
2. Determine panel opening size so not to impede airflow
  - A. From graph intersect 0.035 inches on Y axis
  - B. Draw line to curve—this intersects at 6 CFM/in<sup>2</sup>
  - C. Required vent opening = (240 ÷ 6) = 40 sq. in. opening
  - D. Choose vent size with 40 sq. in. opening or larger

## AIR FLOW VS. RESISTANCE FOR STRAIGHT HONEYCOMB PANEL

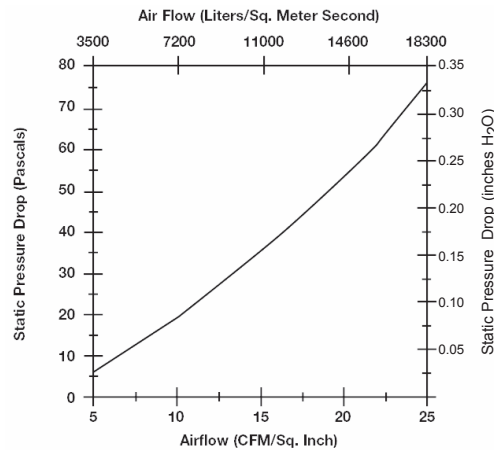

## SHIELDING EFFECTIVENESS FOR VARIOUS MATERIALS AND PLATING COMBINATIONS AT 10-12 INCH LBS TORQUE

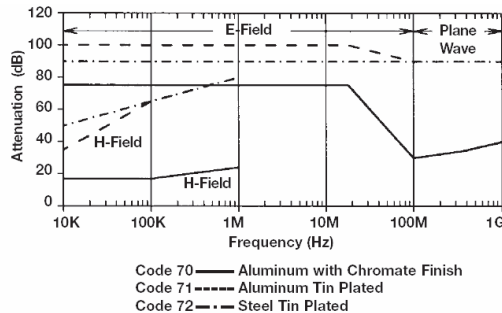

# FABRIC-OVER FOAM

## PRODUCT SELECTION GUIDE

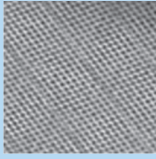
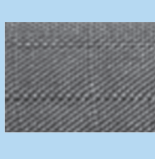
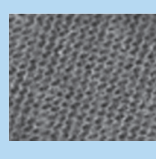
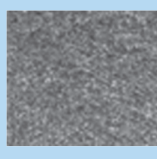
Product Type	Material Designation	Material Type				
		Metal Plating	Base Material / Fabric Type			
		NiCu	Taffeta  Plain Weave Good Shielding Common Use	Ripstop  Ripstop Weave Good Shielding High Abrasion	Mesh  Knitted Breathability	Non-Woven  Bonded Fiber High Shielding Sturdy/Firm

### FABRIC TAPES

Product Type	Material Designation	Metal Plating	Taffeta	Ripstop	Mesh	Non-Woven
Single Sided	86726	X	X			
	86785	X	X			
	86203	X	X			
	86205	X	X			
	87580	X	X			
	86750	X	X			
Double Sided	PNW	X				X
	NNW	X				X
	DN05A	X				X
	DT17A	X	X			

### WRAPPED GASKETS

Product Type	Material Designation	Metal Plating	Taffeta	Ripstop	Mesh	Non-Woven
FOF, Conductive fabric wrapped over non-conductive foam gasketing	51H	X	X			
	51L	X	X			
	501	X	X			
	51G	X		X		
	51Y	X			X	
	T1G	X		X		
	R1G	X		X		
	221	X	X			
	HIK	X		X		
	HIL	X	X			
	51M		X			

### CONDUCTIVE FOAM

Product Type	Material Designation	Metal Plating	Taffeta	Ripstop	Mesh	Non-Woven
CF, Layered and fully conductive foam	G1W	X			X	

#### High Flex Tape Numbering Key

XXXXX XXXX X XXXX

Product Type      Material Width      Size Option      Material Length

Foam	PSA Attachment Method	Material Thickness (mm)	Specifications			Application Specific	
			Temperature	UL Flame	Compression Set	Application Differentiation	Color
Core for Wrapped Gaskets	Acrylic Based Adhesive		Operating Limit			% of Original Height at 70°C	

	CONDUCTIVE	0.13	80°C	-	N/A	CABLE WRAPPING	NICKEL
	CONDUCTIVE	0.12	80°C	-	N/A	GENERAL USE	NICKEL
	CONDUCTIVE	0.10	80°C	-	N/A	CABLE WRAPPING	BLACK
	CONDUCTIVE	0.09	80°C	-	N/A	GENERAL USE	BLACK
	CONDUCTIVE	0.13	80°C	UL510	N/A	UL REQUIRED	GRAY OR BLACK
	CONDUCTIVE	0.08	80°C	-	N/A	THIN APPLICATIONS	NICKEL
	CONDUCTIVE	0.40	80°C	-	N/A	HIGH SHIELDING/ THICK	NICKEL
	CONDUCTIVE	0.60	80°C	-	N/A	HIGH SHIELDING/ THICK	NICKEL
	CONDUCTIVE	0.05	80°C	-	N/A	DOUBLE SIDED	NICKEL
	CONDUCTIVE	0.17	80°C	-	N/A	DOUBLE SIDED	NICKEL

	PU			70°C	UL94V0	< 20	STANDARD	NICKEL
	PU			70°C	UL94V0	< 20	STANDARD	BLACK
	PU			70°C	-	< 20	NON-UL	ni
	PU			70°C	UL94V0	< 20	RIPSTOP FABRIC	ni
	PU			70°C	UL94V0	< 20	MESH / BREATHABLE	NICKEL
	PU	OPTIONAL WITH STANDARD OR CONDUCTIVE	SEE PROFILE SELECTION LIST	70°C	UL94V0	< 15	LOWER COMPRESS	NICKEL
	PU			85°C	UL94V0	< 20	HIGHER TEMP	NICKEL
	PU			70°C	UL94HB	< 20	MOISTURE / FIRM	NICKEL
	PU			70°C	UL94V0	*	COMPLEX / 'C' SHAPES	NICKEL
	PU			70°C	UL94V0	*	COMPLEX / 'C' SHAPES	BLACK
	PU			70°C	UL94V0	< 20	NON-EMI	WHITE

	PU	STANDARD CONDUCTIVE	1.0, 1.5, 2.0, 2.5, 3.2	70°C	UL94V0	< 20	Z-AXIS CONDUCTIVITY / COMPLEX DIE CUTS	NICKEL
--	----	------------------------	----------------------------	------	--------	------	--	--------

**FOF Numbering Key**

4693 - PA - 51H - 01200





# FABRIC-OVER-FOAM METALLIZED SHIELDING GASKETS

Laird is a fully integrated manufacturer of profile and Input/Output (I/O) EMI shielding gaskets. The metallized Fabric-Over-Foam product line has been expanded greatly due to our committed efforts in new product development and meeting or surpassing regulatory requirements.

This catalog is designed to provide helpful information to engineers on our expanded product line. In this section, you will find benefits for Fabric-Over-Foam gaskets, material options and an extensive list of profile and I/O sizes and configurations.

Laird specializes in quick turnaround of custom shapes and sizes of EMI shielding gaskets. If you don't find exactly what you need, our engineers will help you design the right solution to your shielding problem.

A sampling for standard profiles are shown; custom configurations and sizes can be designed to meet your specific requirements. Profiles are shown in ascending order by height (starting on page 58).

The recommended operating compression for Fabric-Over-Foam EMI Gaskets will vary depending on the shape and size of the particular gasket.

Typically, D-Shaped, Rectangular Shaped, and Square Shaped Fabric-Over-Foam EMI Gaskets should be compressed between 30% and 50% of the foam height.

Similarly, C-Shaped Fabric-Over-Foam EMI Gaskets should typically be compressed between 50% and 75% of the gasket height.

Force Displacement Resistance (FDR) graphs are available upon request. Please contact engineering department at Laird when unsure.

Certain combinations of materials may not be available for all Profiles or I/Os. Please consult the Engineering Department at Laird when unsure.

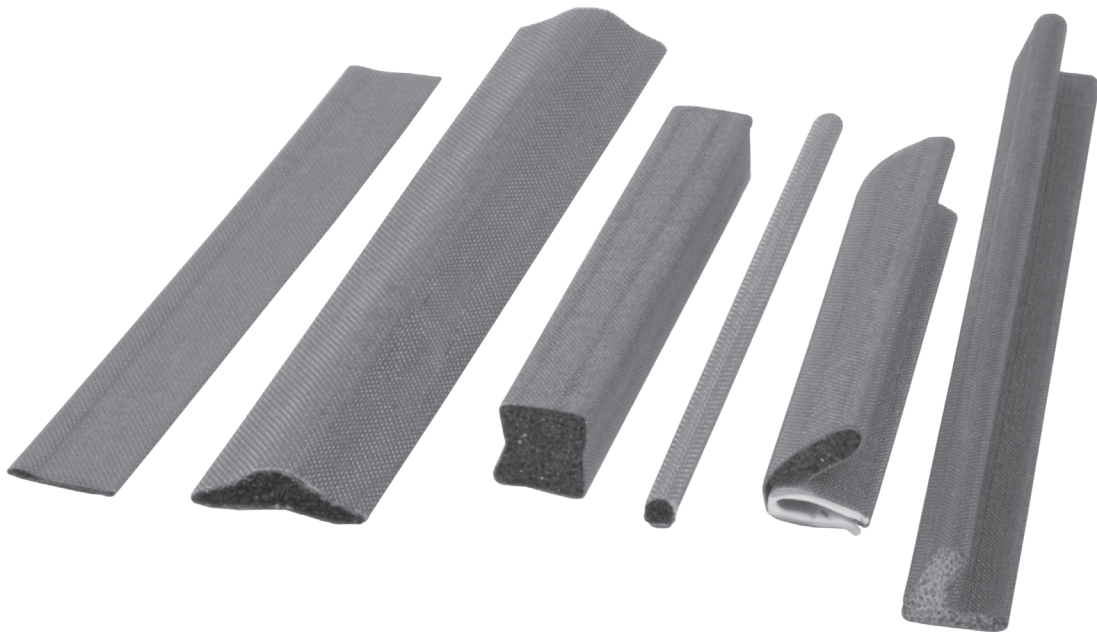

# FABRIC-OVER FOAM

## METALLIZED SHIELDING GASKETS

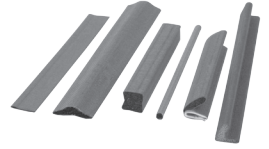

### BENEFITS OF FABRIC-OVER-FOAM GASKETS

- Shielding effectiveness of >100 dB across a wide spectrum of frequencies (see figure 2).
- Extremely low compression forces allow for use of lighter materials (see figure 1).
- Low Surface Resistivity as low as 0.07 ohms/square dependent on the fabric. Fabric-Over-Foam gaskets provide improved conductivity (ASTM F390).
- A wide range of flame retardant gaskets are available (UL recognized per UL94 V0 or UL94 HB). More information is available at ul.com.
- Abrasion resistant metallized fabrics show virtually no degradation in shielding performance.
- Urethane core provide low compression set ensuring long-term reliability of gasket performance. Contact Engineering for profile specific data.
- Service temperatures from -40°F to 158°F (-40°C to 85°C).
- Available in Nickel/Copper (Ni/Cu) and Tin/Copper (Sn/Cu) to ensure galvanic compatibility with a wide variety of host materials. Both versions display no significant performance degradation after environmental exposure per the Accelerated Aging Test (ASTM B845-93 Method H).
- Prototype samples can be provided quickly utilizing laser technology, CAD/CAM equipment, and customer supplied drawings in DWG®, DXF®, IGS, PRT®, DRW®, STP®, and CT® file formats.
- Profile and I/O gaskets are available with a variety of pressure sensitive adhesive (PSA) tapes, including Easy Peel® with extra wide release liner to facilitate quick assembly.
- Profile gaskets can be cut to specified lengths, kiss-cut on release liner, or mitered to form frame configurations.
- UL94 V0 and Halogen-free gaskets to meet stringent environmental / safety requirements

**FIGURE 2**

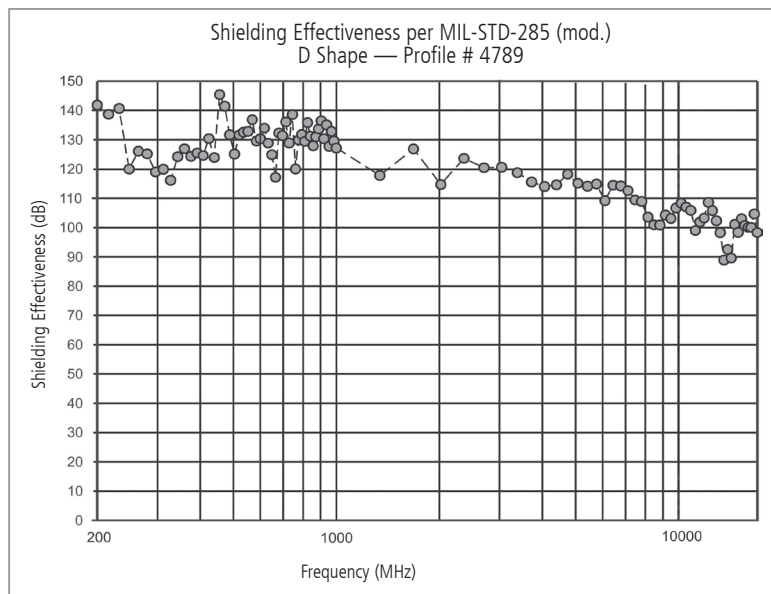

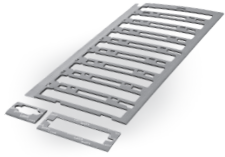

# ECOGREEN™

## ENVIRONMENTALLY FRIENDLY FABRIC-OVER-FOAM SHIELDING GASKETS

Laird is pleased to introduce the next generation in RoHS-compliant EMI shielding technology.

While Laird Fabric-Over-Foam EMI gaskets are RoHS compliant, we are proactively strengthening our compliancy by engineering halogen-free EcoGreen™ shields.

Not only are the patented EcoGreen™ shields environmentally friendly, they offer high EMI shielding effectiveness, extremely low compression forces, abrasion-resistant metallized fabrics, large service temperature ranges, and multiple profile/gasket options.

Laird shields are flame retardant and pass the stringent UL94-VO burn test and the whole gasket is Halogen-free.

### ENVIRONMENT & SAFETY

- Halogen-free and RoHS compliant; per the IEC 61249-2-21 standard
- UL94 V0

### PERFORMANCE AND BENEFITS

- Profiles and I/O gaskets are available with a pressure sensitive adhesive (PSA) tape
- Profiles can be cut to specified lengths, kiss-cut release liner or mitered to form frame configurations

### HIGH SHIELDING EFFECTIVENESS

- Shielding effectiveness of > 100 dB
- Extremely low compression forces allow lighter weight materials, with less fastening and hinge hardware.
- Low surface resistivity as low as <0.07 ohms/square provides improved conductivity (ASTM F390)
- Service temperature range from - 40°F to 158°F (- 40°C to 70°C)

### APPLICATIONS

- Computer servers
- Desktop computers
- Digital cameras
- Internal/external hard drives
- Liquid Crystal Displays (LCDs)
- Medical equipment
- Notebook computers
- Plasma Display Panels (PDPs)
- Printers
- Set-top boxes
- Telecommunications enclosure cabinets

### AGENCY APPROVALS

- UL designation VO 041
- UL file #OCDT2.E170327
- More information is available at ul.com

FIGURE 1

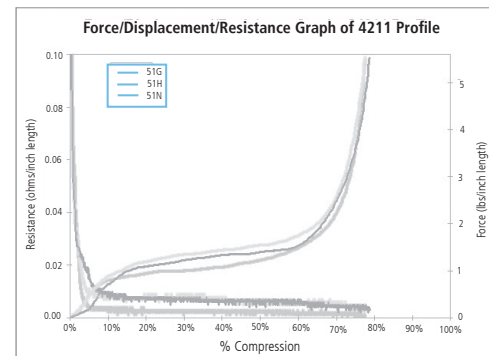

### Fabric

Fabric Type	Metal Coating	Conductivity	Application	Benefits
Ripstop	Ni/Cu	<0.07 ohms/square	I/O or Profile Gaskets	Flame retardant, high abrasion resistance
Taffeta	Ni/Cu	<0.07 ohms/square	I/O or Profile Gaskets	Flame retardant, abrasion resistant
Knit Mesh	Ni/Cu	<0.10 ohms/square	I/O or Profile Gaskets	Low cost, flame retardant
Black Taffeta	Ni/Cu	<0.07 ohms/square	I/O or Profile Gaskets	Black UL94V0, similar properties to Taffeta fabric
High Performance Taffeta	Ni/Cu	<0.05 ohms/square	I/O or Profile Gaskets	EMI tape, highest shielding effectiveness

### Foam

Foam Type	Compression Set (ASTM D 3574)	Color	Application	Benefits
Urethane (Polyester)	5-10%	Charcoal	I/O or Profile Gaskets	Simple, moderate shapes, low compression force/compression set, flame retardant

### Pressure Sensitive Adhesive

Pressure Sensitive Adhesive	Thickness	Benefits
Acrylic Non-conductive	0.005"	High Peel Strength, Temperature Resistant
Acrylic Conductive	0.004"	Electrically Conductive in Z-Axis Direction

# FABRIC-OVER-FOAM I/O GASKET SELECTION GUIDE

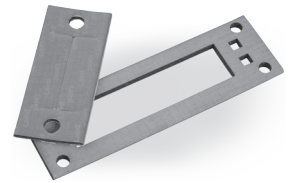

## Part Number Example:

Digits: 1 2 3 4    5 6    7 8 9    10 11 12 13 14

4 6 9 3 - PA - 5 1 H - 0 1 2 0 0

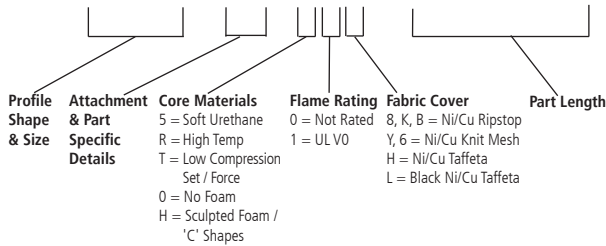

\* Certain combinations of materials may not be available for all Profiles or I/Os. Please consult the Engineering Department at Laird when unsure.

See back cover for contact information.

### DIGITS 1 THROUGH 4

Designate profile number. Select profile or I/O and sizes from pages 58-61 (Profile) or 62-64 (I/O).

### DIGITS 5 THROUGH 6

Designate part-specific attributes of the product including cutouts, notches, tape and a variety of other customized details. PA STD PSA / PB STD PSA W/ ERL / PC STD CPSA

### DIGITS 7 THROUGH 9

Designate the core materials, flame rating and fabric cover combinations. Select these options from the recommended list in the table below.

### DIGITS 10 THROUGH 14

Designate the part length in inches to two decimal places. For the example shown above, the "01200" denotes a 12.00 inch (304,8 mm) long gasket).

Fabric	Non-Rated RoHS Compliant	UL94-VO Rated RoHS Compliant	UL94-VO Rated RoHS Compliant Halogen-Free EcoGreen™	Typical Apps	Shielding
Ni/Cu Mesh	506		51N	Compos Only	Medium
Ni/Cu Taffeta	501		51H	Comp/Shear	High
Ni/Cu NRS	50B		51G	Comp/Shear	High
Ni/Cu NRS		H1K		C-Fold Only	High
Sn/Cu NRS			51S	Comp/Shear Harsh Environment	High
Ni/Cu NRS			T1G	Low Compression Set / Force	High
Ni/Cu NRS			R1G	85°C Applications	High
Ni/Cu Black Taffeta			51L	Visible Applications	High



All parts listed in this catalog are lead free and RoHS compliant.

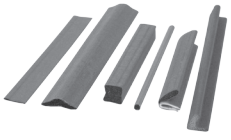

# FABRIC-OVER-FOAM PROFILE SELECTION GUIDE

## D-SHAPED

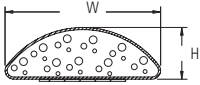

Profile Number	inches (mm) H	inches (mm) W
4584	0.040 (1,0)	0.150 (3,8)
4320	0.050 (1,3)	0.140 (3,6)
4541	0.050 (1,3)	0.250 (6,4)
4358	0.060 (1,5)	0.098 (2,5)
4184	0.060 (1,5)	0.150 (3,8)
4548	0.060 (1,5)	0.250 (6,4)
4356	0.070 (1,8)	0.180 (4,6)
4052	0.080 (2,0)	0.080 (2,0)
4283	0.080 (2,0)	0.157 (4,0)
4181	0.080 (2,0)	0.394 (10,0)
4053	0.090 (2,3)	0.090 (2,3)
4912	0.090 (2,3)	0.150 (3,8)
4375	0.094 (2,4)	0.200 (5,1)
4240	0.100 (2,5)	0.300 (7,6)
4742	0.120 (3,0)	0.150 (3,8)
4202	0.120 (3,0)	0.250 (6,4)
4078	0.120 (3,0)	0.360 (9,1)
4090	0.125 (3,2)	0.090 (2,3)

Profile Number	H inches (mm) H	W inches (mm) W
4906	0.130 (3,3)	0.188 (4,8)
4692	0.140 (3,6)	0.250 (6,4)
4228	0.150 (3,8)	0.150 (3,8)
4123	0.150 (3,8)	0.354 (9,0)
4112	0.158 (4,0)	0.433 (11,0)
4120	0.160 (4,1)	0.240 (6,1)
4295	0.170 (4,3)	0.250 (6,4)
4609	0.180 (4,6)	0.400 (10,2)
4787	0.200 (5,1)	0.250 (6,4)
4134	0.197 (5,0)	0.394 (10,0)
4607	0.200 (5,1)	0.480 (12,2)
4242	0.250 (6,4)	0.250 (6,4)
4542	0.248 (6,3)	0.291 (7,4)
4789	0.250 (6,4)	0.375 (9,5)
4368	0.299 (7,6)	0.272 (6,9)
4105	0.375 (9,5)	0.500 (12,7)
4060	0.500 (12,7)	0.500 (12,7)

## RECTANGLE SHAPED

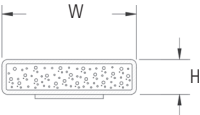

Profile Number	inches (mm) H	inches (mm) W
*4570	0.015 (0,4)	0.200 (5,1)
*4577	0.015 (0,4)	0.276 (7,0)
*4572	0.015 (0,4)	0.394 (10,0)
*4300	0.017 (0,4)	0.826 (21,0)
*4058	0.020 (0,5)	0.157 (4,0)
*4569	0.020 (0,5)	0.196 (5,0)
*4500	0.020 (0,5)	1.217 (30,9)
*4501	0.020 (0,5)	1.970 (50,0)
*4850	0.030 (0,8)	0.900 (22,9)
4245	0.040 (1,0)	0.120 (3,0)
4223	0.040 (1,0)	0.157 (4,0)
4220	0.040 (1,0)	0.200 (5,1)
4404	0.040 (1,0)	0.236 (6,0)
4215	0.040 (1,0)	0.275 (7,0)
4208	0.040 (1,0)	0.395 (10,0)
4219	0.040 (1,0)	0.510 (13,0)
4259	0.040 (1,0)	0.600 (15,2)
4677	0.040 (1,0)	0.709 (18,0)
4532	0.040 (1,0)	0.750 (19,1)
4597	0.040 (1,0)	0.900 (22,9)
4297	0.040 (1,0)	1.000 (25,4)
4363	0.040 (1,0)	1.126 (28,6)
4179	0.040 (1,0)	1.431 (36,3)
4512	0.040 (1,0)	1.640 (41,7)
4270	0.040 (1,0)	1.770 (45,0)
4573	0.040 (1,0)	1.840 (46,7)
4394	0.040 (1,0)	3.300 (83,8)
4246	0.050 (1,3)	0.090 (2,3)
4088	0.050 (1,3)	0.220 (5,6)
4086	0.060 (1,5)	0.850 (21,6)
4273	0.060 (1,5)	0.125 (3,2)
4056	0.060 (1,5)	0.200 (5,1)
4157	0.060 (1,5)	0.280 (7,1)
4629	0.060 (1,5)	0.394 (10,0)
4051	0.060 (1,5)	0.500 (12,7)
4455	0.060 (1,5)	0.551 (14,0)
4430	0.060 (1,5)	0.591 (15,0)
4626	0.060 (1,5)	0.608 (15,4)
4606	0.060 (1,5)	0.620 (15,7)
4579	0.060 (1,5)	0.650 (16,5)
4164	0.060 (1,5)	0.750 (19,1)

Profile Number	inches (mm) H	inches (mm) W
4170	0.060 (1,5)	0.866 (22,0)
4225	0.060 (1,5)	0.900 (22,9)
4080	0.060 (1,5)	1.000 (25,4)
4599	0.060 (1,5)	1.063 (27,0)
4518	0.060 (1,5)	1.235 (31,4)
4079	0.060 (1,5)	1.330 (33,8)
4161	0.060 (1,5)	1.370 (34,8)
4163	0.060 (1,5)	1.400 (35,6)
4591	0.060 (1,5)	1.455 (37,0)
4091	0.060 (1,5)	1.525 (38,7)
4628	0.060 (1,5)	1.575 (40,0)
4231	0.060 (1,5)	1.615 (41,0)
4679	0.060 (1,5)	1.693 (43,0)
4408	0.060 (1,5)	1.740 (44,2)
4148	0.060 (1,5)	1.878 (47,7)
4169	0.060 (1,5)	1.900 (48,3)
4160	0.060 (1,5)	2.305 (58,5)
4235	0.060 (1,5)	2.52 (64,0)
4596	0.060 (1,5)	3.091 (78,5)
4907	0.060 (1,5)	3.780 (96,0)
4071	0.062 (1,6)	0.300 (7,6)
4171	0.062 (1,6)	0.870 (22,1)
4143	0.062 (1,6)	2.000 (50,8)
4268	0.070 (1,8)	0.160 (4,1)
4302	0.070 (1,8)	0.551 (14,0)
4199	0.070 (1,8)	0.650 (16,5)
4410	0.070 (1,8)	1.063 (27,0)
4688	0.079 (2,0)	0.118 (3,0)
4392	0.079 (2,0)	0.354 (9,0)
4094	0.080 (2,0)	0.160 (4,1)
4186	0.080 (2,0)	0.200 (5,1)
4602	0.080 (2,0)	0.236 (6,0)
4096	0.080 (2,0)	0.275 (7,0)
4650	0.080 (2,0)	0.295 (7,5)
4601	0.080 (2,0)	0.315 (8,0)
4357	0.080 (2,0)	0.394 (10,0)
4182	0.080 (2,0)	0.400 (10,2)
4675	0.080 (2,0)	0.535 (13,6)
4359	0.080 (2,0)	0.710 (18,0)
4571	0.080 (2,0)	0.787 (20,0)
4200	0.080 (2,0)	0.827 (21,0)

All dimensions shown are in inches (millimeters) unless otherwise specified.  
 \* Gaskets less than 0.040" thick are constructed without foam.

# FABRIC-OVER-FOAM PROFILE SELECTION GUIDE

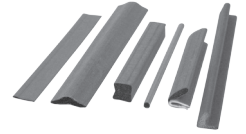

## Rectangle Shaped Continued

Profile Number	inches (mm) H	inches (mm) W
4361	0.080 (2,0)	0.900 (22,9)
4325	0.080 (2,0)	0.984 (25,0)
4194	0.080 (2,0)	1.126 (28,6)
4389	0.080 (2,0)	1.259 (32,0)
4315	0.080 (2,0)	1.345 (34,2)
4531	0.080 (2,0)	1.550 (39,4)
4263	0.080 (2,0)	1.615 (41,0)
4260	0.080 (2,0)	1.842 (46,8)
4262	0.080 (2,0)	1.736 (44,1)
4355	0.080 (2,0)	5.340 (135,6)
4339	0.090 (2,3)	0.200 (5,1)
4903	0.090 (2,3)	0.535 (13,6)
4248	0.090 (2,3)	1.060 (26,9)
4254	0.090 (2,3)	1.370 (34,8)
4255	0.090 (2,3)	1.655 (42,0)
4256	0.090 (2,3)	1.700 (43,2)
4801	0.100 (2,5)	0.265 (6,7)
4082	0.100 (2,5)	0.375 (9,5)
4612	0.100 (2,5)	0.500 (12,7)
4133	0.100 (2,5)	0.354 (9,0)
4285	0.100 (2,5)	1.330 (33,8)
4582	0.100 (2,5)	1.500 (38,1)
4330	0.100 (2,5)	1.625 (41,3)
4083	0.110 (2,8)	0.240 (6,1)
4042	0.118 (3,0)	0.125 (3,2)
4619	0.118 (3,0)	0.197 (5,0)
4272	0.118 (3,0)	0.315 (8,0)
4286	0.118 (3,0)	0.394 (10,0)
4583	0.118 (3,0)	0.787 (20,0)
4126	0.118 (3,0)	1.717 (43,6)
4209	0.120 (3,0)	0.155 (3,9)
4210	0.120 (3,0)	0.355 (9,0)
4264	0.120 (3,0)	0.750 (19,1)
4536	0.120 (3,0)	1.551 (39,4)
4788	0.125 (3,2)	0.250 (6,4)
4694	0.125 (3,2)	0.500 (12,7)
4065	0.125 (3,2)	0.600 (15,2)
4247	0.125 (3,2)	0.700 (17,8)
4376	0.125 (3,2)	0.720 (18,3)
4064	0.125 (3,2)	1.000 (25,4)
4603	0.125 (3,2)	1.125 (28,6)
4066	0.125 (3,2)	1.250 (31,8)
4158	0.125 (3,2)	1.400 (35,6)
4239	0.125 (3,2)	1.615 (41,0)
4238	0.125 (3,2)	1.850 (47,0)
4693	0.130 (3,3)	0.190 (4,8)
4062	0.130 (3,3)	0.380 (9,7)
4694	0.130 (3,3)	0.500 (12,7)
4632	0.125 (3,2)	1.625 (41,3)
4575	0.125 (3,2)	2.000 (50,8)
4615	0.138 (3,5)	0.197 (5,0)
4594	0.138 (3,5)	0.350 (8,9)
4525	0.140 (3,6)	0.512 (13,0)
4203	0.150 (3,8)	0.100 (2,5)
4047	0.150 (3,8)	0.500 (12,7)
4533	0.156 (4,0)	0.630 (16,0)
4799	0.156 (4,0)	0.650 (16,5)
4914	0.156 (4,0)	0.709 (18,0)
4499	0.157 (4,0)	0.197 (5,0)
4741	0.157 (4,0)	0.256 (6,5)

Profile Number	inches (mm) H	inches (mm) W
4055	0.157 (4,0)	0.315 (8,0)
4516	0.157 (4,0)	0.354 (9,0)
4791	0.157 (4,0)	0.394 (10,0)
4098	0.157 (4,0)	0.591 (15,0)
4704	0.158 (4,0)	0.236 (6,0)
4241	0.160 (4,1)	0.200 (5,1)
4253	0.160 (4,1)	0.280 (7,1)
4114	0.158 (4,0)	0.433 (11,0)
4115	0.160 (4,1)	0.590 (15,0)
4249	0.160 (4,1)	0.790 (20,1)
4257	0.160 (4,1)	0.880 (22,4)
4252	0.160 (4,1)	0.985 (25,0)
4250	0.160 (4,1)	1.375 (34,9)
4251	0.160 (4,1)	1.700 (43,2)
4142	0.177 (4,5)	0.354 (9,0)
4370	0.180 (4,6)	2.000 (50,8)
4902	0.196 (5,0)	0.315 (8,0)
4258	0.190 (4,8)	1.625 (41,3)
4698	0.195 (5,0)	0.130 (3,3)
4211	0.195 (5,0)	0.395 (10,0)
4674	0.197 (5,0)	0.512 (13,0)
4360	0.197 (5,0)	0.591 (15,0)
4281	0.200 (5,1)	3.900 (99,1)
4365	0.216 (5,5)	0.394 (10,0)
4100	0.216 (5,5)	0.500 (12,7)
4786	0.217 (5,5)	0.394 (10,0)
4528	0.217 (5,5)	0.709 (18,0)
4087	0.225 (5,7)	0.218 (5,5)
4701	0.250 (6,4)	0.375 (9,5)
4795	0.250 (6,4)	0.500 (12,7)
4798	0.250 (6,4)	0.600 (15,2)
4226	0.250 (6,4)	0.750 (19,1)
4224	0.250 (6,4)	1.000 (25,4)
4705	0.256 (6,5)	0.236 (6,0)
4740	0.256 (6,5)	0.394 (10,0)
4649	0.275 (7,0)	0.394 (10,0)
4568	0.275 (7,0)	0.511 (13,0)
4113	0.276 (7,0)	0.433 (11,0)
4227	0.283 (7,2)	1.180 (30,0)
4222	0.295 (7,5)	0.591 (15,0)
4237	0.295 (7,5)	1.500 (38,1)
4057	0.315 (8,0)	0.157 (4,0)
4687	0.315 (8,0)	0.236 (6,0)
4216	0.315 (8,0)	0.395 (10,0)
4610	0.335 (8,5)	0.394 (10,0)
4702	0.375 (9,5)	0.250 (6,4)
4081	0.375 (9,5)	0.500 (12,7)
4070	0.375 (9,5)	0.750 (19,1)
4192	0.375 (9,5)	1.000 (25,4)
4176	0.394 (10,0)	0.787 (20,0)
4513	0.413 (10,5)	0.394 (10,0)
4173	0.413 (10,5)	0.512 (13,0)
4524	0.452 (11,5)	0.472 (12,0)
4391	0.500 (13,0)	0.984 (25,0)
4172	0.591 (15,0)	0.394 (10,0)
4233	0.600 (15,2)	1.000 (25,4)
4136	0.670 (17,0)	0.591 (15,0)
4900	0.700 (17,8)	0.500 (12,7)
4686	0.709 (18,0)	0.394 (10,0)
4744	0.787 (20,0)	0.580 (14,7)

All dimensions shown are in inches (millimeters) unless otherwise specified.

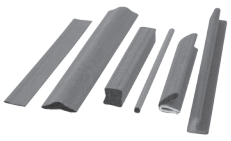

# FABRIC-OVER-FOAM PROFILE SELECTION GUIDE

## SQUARE SHAPED

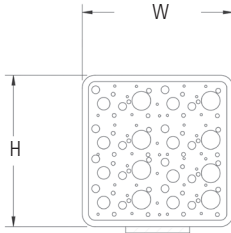

Profile Number	inches (mm) H	inches (mm) W
4520	0.080 (2,0)	0.080 (2,0)
4046	0.118 (3,0)	0.118 (3,0)
4522	0.157 (4,0)	0.157 (4,0)
4212	0.195 (5,0)	0.195 (5,0)
4048	0.236 (6,0)	0.236 (6,0)
4049	0.250 (6,4)	0.250 (6,4)
4695	0.375 (9,5)	0.375 (9,5)
4206	0.395 (10,0)	0.395 (10,0)
4084	0.500 (12,7)	0.500 (12,7)
4204	0.670 (17,0)	0.670 (17,0)
4517	0.750 (19,1)	0.750 (19,1)
4089	0.787 (20,0)	0.787 (20,0)

## C-FOLD SHAPED

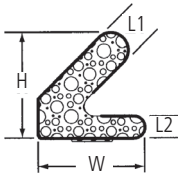

Profile Number	inches (mm) H	inches (mm) W	inches (mm) L1	inches (mm) L2
4593	0.250 (6,4)	0.280 (7,1)	0.125 (3,2)	0.060 (1,5)
4168	0.315 (8,0)	0.315 (8,0)	0.080 (2,0)	0.080 (2,0)
4198	0.385 (9,8)	0.420 (10,7)	0.115 (2,9)	0.060 (1,5)
4243	0.400 (10,2)	0.430 (10,9)	0.125 (3,2)	0.060 (1,5)
4600	0.415 (10,5)	0.450 (11,4)	0.135 (3,4)	0.650 (1,7)
4529	0.465 (11,8)	0.420 (10,7)	0.115 (2,9)	0.060 (1,5)
4697	0.675 (17,1)	0.590 (15,0)	0.165 (4,2)	0.156 (4,0)
4703	0.947 (24,1)	0.550 (14,0)	0.157 (4,0)	0.170 (4,3)

## BELL SHAPED

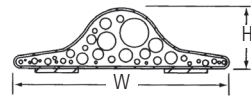

Profile Number	inches (mm) H	inches (mm) W
4630	0.070 (1,8)	0.180 (4,6)
4379	0.070 (1,8)	0.564 (14,3)
4387	0.080 (2,0)	0.675 (17,1)
4633	0.100 (2,5)	0.300 (7,6)
4131	0.140 (3,6)	0.500 (12,7)

## KNIFE SHAPED

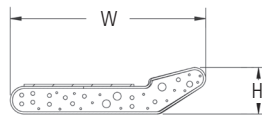

Profile Number	inches (mm) H	inches (mm) W
4797	0.106 (2,7)	0.445 (11,3)
4097	0.106 (2,7)	0.315 (8,0)
4796	0.110 (2,8)	0.450 (11,4)
4205	0.250 (6,4)	0.750 (19,1)
4106	0.312 (7,9)	0.707 (18,0)
4189	0.350 (8,9)	0.750 (19,1)

## P-SHAPED

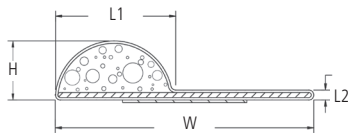

Profile Number	inches (mm) H	inches (mm) W	inches (mm) L1	inches (mm) L2
4150	0.118 (3,0)	0.520 (13,2)	0.242 (6,1)	0.020 (0,50)
4699	0.145 (3,7)	0.520 (13,2)	0.150 (3,8)	0.020 (0,50)
4792	0.200 (5,1)	0.480 (12,2)	0.170 (4,3)	0.090 (2,3)
4537	0.374 (9,5)	0.887 (22,5)	0.500 (13,0)	0.051 (1,0)

## J-SHAPED

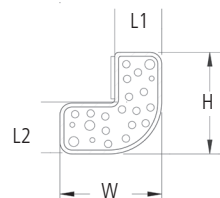

Profile Number	inches (mm) H	inches (mm) W	inches (mm) L1	inches (mm) L2
4117	0.130 (3,3)	0.130 (3,3)	0.060 (1,5)	0.065 (1,7)
4054	0.209 (5,3)	0.130 (3,3)	0.063 (1,6)	0.071 (1,8)
4502	0.400 (10,2)	0.300 (7,6)	0.175 (4,4)	0.140 (3,6)

All dimensions shown are in inches (millimeters) unless otherwise specified.

# FABRIC-OVER-FOAM PROFILE SELECTION GUIDE

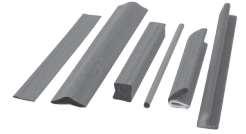

## DOUBLE D-SHAPED

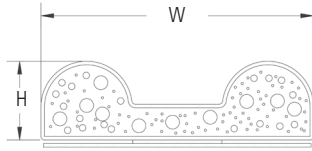

Profile Number	inches (mm) H	inches (mm) W
4299	0.110 (2,8)	0.382 (9,7)

## L-SHAPED

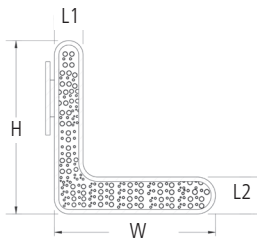

Profile Number	inches (mm) H	inches (mm) W	inches (mm) L1	inches (mm) L2
4469	0.216 (5,5)	0.354 (9,0)	.138 (3,5)	.118 (3,0)
4534	0.591 (15,0)	0.551 (14,0)	.098 (2,5)	.126 (3,2)

## ROUND SHAPED

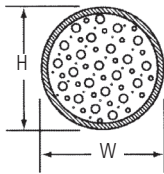

Profile Number	inches (mm) H	inches (mm) W
4201	0.100 (2,5)	0.100 (2,5)
4372	0.125 (3,2)	0.125 (3,2)

## T-SHAPED

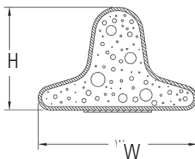

Profile Number	inches (mm) H	inches (mm) W
4349	0.157 (4,0)	0.244 (6,2)
4857	0.172 (4,4)	0.244 (6,2)
4A58	0.152 (3,9)	0.235 (6,0)



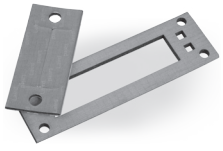

# FABRIC-OVER-FOAM I/O SELECTION GUIDE

## DIVERSE ASSEMBLY OPTIONS

Multiple attachment options provide a variety of ways to install critical EMI products. Pressure Sensitive Adhesive (PSA) has been complemented with the Easy Peel® release liner and rigid clip configurations. These mechanical attachment options enable you to take advantage of existing tooling on doors and enclosures as well as offer alternate attachment methods to better meet design requirements.

### D-SHAPED CLIP

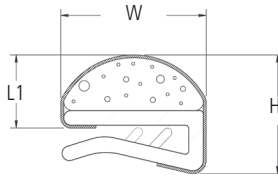

Profile Number	inches (mm) H	inches (mm) W	inches (mm) L1
4110	0.203(5,2)	0.250 (6,4)	0.125 (3,2)
4111	0.243(6,2)	0.250 (6,4)	0.165 (4,2)
4039	0.304(7,7)	0.480 (12,2)	0.195 (5,0)
4033	0.35(8,9)	0.480 (12,2)	0.240 (6,1)
4121	0.358(9,1)	0.250 (6,4)	0.280 (7,1)
4040	0.41(10,4)	0.480 (12,2)	0.300 (7,6)
4038	0.43(10,9)	0.490 (12,4)	0.310 (7,9)
4043	0.43(10,9)	0.490 (12,4)	0.310 (7,9)
4085	0.43(10,9)	0.490 (12,4)	0.310 (7,9)
4041	0.568(14,4)	0.480 (12,2)	0.458 (11,6)

### RECTANGLE SHAPED CLIP

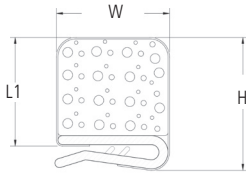

Profile Number	inches (mm) H	inches (mm) W	inches (mm) L1
4913	0.440 (11,2)	0.375 (9,5)	0.360 (9,1)
4413	0.485 (12,3)	0.390 (9,9)	0.405 (10,3)

### C-FOLD WITH CLIP

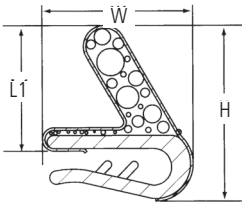

Profile Number	inches (mm) H	inches (mm) W	inches (mm) L1
4E42	0.335 (8,5)	0.284 (7,3)	0.240 (6,1)

All dimensions shown are in inches (millimeters) unless otherwise specified.

## PROFILE GASKET TOLERANCES

Profile	Tolerance Inches (Millimeters)
Height & Width	± .020 (0,5)
Length Inches (Millimeters)	Tolerance Inches (Millimeters)
1 to 6 (25,4 – 152,4)	± .030 (0,8)
>6 to 11 (152,4 – 279,4)	± .050 (1,3)
>11 to 48 (279,4 – 1219,2)	± .100 (2,5)
>48 to 70 (1219,2 – 1778,0)	± .187 (4,7)
>70 to 96 (1778,0 – 2438,4)	± .250 (6,4)

For parts shorter than 1 inch (25,4 mm), or longer than 96" (2438,4 mm), please consult Engineering for tolerances. See back cover for contact information.

All dimensions shown are in inches (millimeters) unless otherwise specified.

# FABRIC-OVER-FOAM I/O SELECTION GUIDE

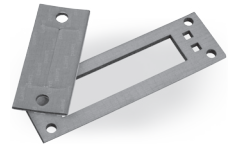

The following pages show examples of standard I/O gaskets used in computer and telecommunication applications. If you have different requirements, the Engineering Department will design gaskets to the specifications you supply. Laird will design your I/O from a fully detailed print, drawing file, or the actual panel to which the gasket is to be applied.

I/O GASKET TOLERANCES	
Height tolerance	$\pm .020''$ ( $\pm 0.5$ mm)
Width tolerance	$\pm .020''$ ( $\pm 0.5$ mm)
Length tolerance	$\pm .020''$ ( $\pm 0.5$ mm)
Cutout tolerance	$\pm .020''$ ( $\pm 0.5$ mm)

If different tolerances are required, please consult Engineering. See back cover for contact information.

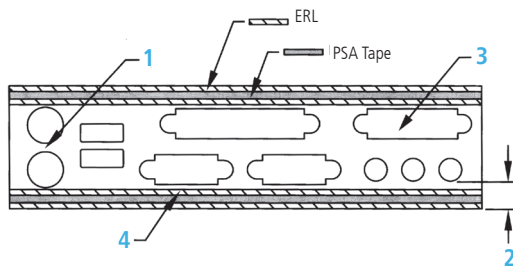

## BASIC I/O GASKET DESIGN

1. Space between required cutouts should match or exceed 0.060" (1,5 mm).
2. Distance from the edge of a cutout should be at least 0.060" (1,5 mm) from the edge of the gasket. In most cases, a slot can be used in place of a hole that is positioned too close to the gasket edge.
3. All cutouts and locations are designed customer specifications.
4. Pressure Sensitive Adhesive (PSA) and Extended Release Liner (ERL) can be applied in parallel with the long edge of the gasket.

The recommended operating compression for Fabric-Over-Foam EMI gaskets will vary depending on the shape and size of the particular gasket. Typically, I/O gaskets should be compressed between 30% and 50% of the foam height.

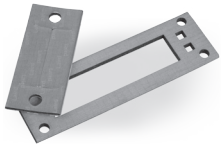

# FABRIC-OVER-FOAM I/O GASKET SELECTION GUIDE

## SCSI + 50 PIN CONNECTOR, PART NUMBER 4164-FE

Usage: Peripheral, Hard Disk, CD-ROM



## SCSI + 68 PIN CONNECTOR, PART NUMBER 4164-FF

Usage: Peripheral, External Hard Drive

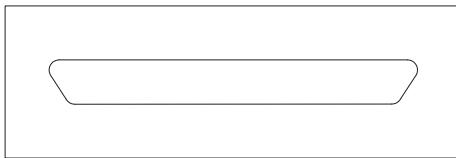

## RJ-11 CONNECTOR, PART NUMBER 4164-FH

Usage: Telecom, Ethernet Networking

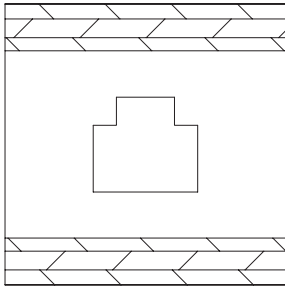

## USB PORT 4 PIN CONNECTOR, PART NUMBER 4219-EB

Usage: Multi-use, hot plug-and-play

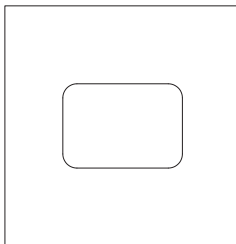

## IEEE 1394 I/O 4 Pin Connector, Part Number 4051-EE

Usage: Plug-and-Play Serial Port (Digital Cameras, Printers, Keyboards, Mouse)

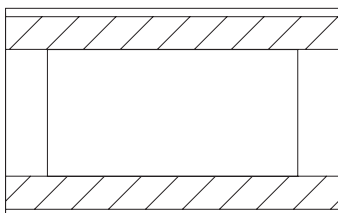

## D-SUB CONNECTOR SERIES

Laird Part number	D-Sub Pins	D-Sub Design	PSA
4N64EA51N00138	9	Female	No
4N64EB51N00138	9	Male	No
4N64EC51N00171	15	Female	No
4N64ED51N00171	15	Male	No
4N64EE51N00225	25	Female	No
4N64EF51N00225	25	Male	No
4N64EG51N00290	37	Female	No
4N64EH51N00290	37	Male	No
4N64EJ51N00281	50	Female	No
4N64EK51N00281	50	Male	No
4N64EL51N00138	9	Female	Yes
4N64EM51N00138	9	Male	Yes
4N64EM51N00171	15	Female	Yes
4N64EP51N00171	15	Male	Yes
4N64ER51N00225	25	Female	Yes
4N64ES51N00225	25	Male	Yes
4N64ET51N00290	37	Female	Yes
4N64EU51N00290	37	Male	Yes
4N64EV51N00281	50	Female	Yes
4N64EW51N00281	50	Male	Yes

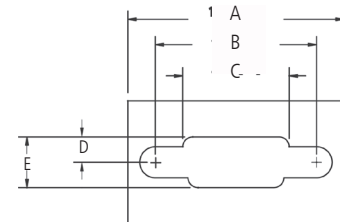

.060 (1,5)

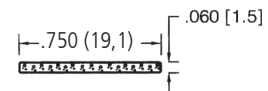

# KNITTED CONDUCTIVE GASKETS

## EXCELLENT VERSATILE SHIELDING PERFORMANCE WITH GREAT VARIETY

Wire mesh gaskets are a very versatile and proven style of shielding. Wire mesh gaskets have a great variety of uses and there are several popular types to choose from depending on shielding or environmental requirements. Knitted gaskets can be made from a variety of metal wires, including monel, tin plated-copper clad-steel or aluminum. Cost-effective for low cycling applications with high shielding effectiveness over a broad frequency range. Available in a wide variety of sizes and shapes, the knit construction provides long lasting resiliency with versatile mounting options. Available with elastomer gasket for moisture and dust sealing.

Popular product lines include the ElectroNit™ All Mesh, which is the most economical gasket for low cycling applications and is designed to offer the highest levels of attenuation. UltraSoft™ Knit offers close-knit stitch of the metallized nylon provides a highly effective EMI shield, as well as a smooth, soft surface. UltraFlex™ Copper Beryllium (CuBe) Mesh offers superb resiliency for consistent, point-to-point contact requiring the lowest compression forces among all other shielding materials and configurations.

Elastomer Core Mesh is an optimum solution for combining excellent shielding performance with a high degree of elasticity. Electro-Con oriented wire provides EMI protection and seals against moisture or rain on cast or machined surfaces.

Laird maintains a sophisticated global manufacturing network and this, coupled with state-of-the-art design technology, ensures market leading products ideal for your application.



### Clips, Washers, Tape, etc

Useful in applications where the need for EMI protection is required.



### Electronit All Mesh EMI Gasketing

EMI gasketing that has been designed to offer the highest possible levels of attenuation.



### Elastomer Core Mesh Gasketing

Elastomer core that offers low compression requirements and low compression set.



### Ultraflex Electronit Beryllium Copper Knitted Wire Shielding

Optimum mechanical properties of beryllium copper with shielding effectiveness as much as 20 dB higher than conventional materials.

# KNITTED CONDUCTIVE GASKETS

## VISUAL PART REFERENCE GUIDE

### UltraFlex ElectroNit BeCu Knitted Wire Shielding

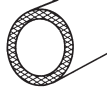

Hollow Core Round

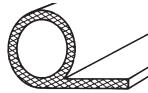

Hollow Core Round with Single Fin



Hollow Core Double Round

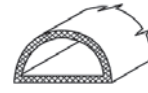

UltraFlex "D" Shape

### ElectroNit All Mesh EMI Gasketing

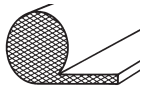

All Mesh Single Round with Fin Strip

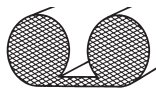

All Mesh Double Round with Fin Strip

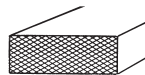

All Mesh Rectangular Strip

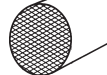

All Mesh Round Strip



Enviro-Seal Strip with Pressure-Sensitive Adhesive



Double Shield Enviro-Seal Strip with Pressure-Sensitive Adhesive

### ElectroNit Elastomer Core EMI Gasketing

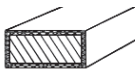

Rectangular with Sponge Elastomer

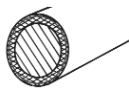

Round with Sponge Elastomer



Round with Silicone Elastomer Tubing

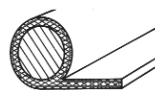

Single Fin with Sponge Elastomer

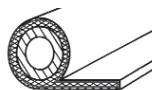

Single Fin with Silicone Elastomer Tubing

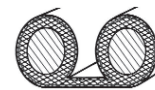

Double Fin with Sponge Elastomer

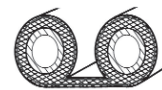

Double Fin with Silicone Elastomer Tubing

### Electronit supersoft



### ElectroGround EMI Washers

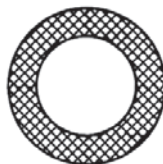

### ElectroMesh Tape

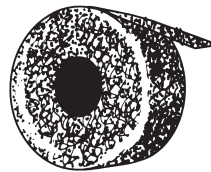

### UltraSoft Knit

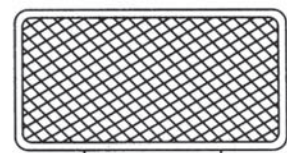

# KNITTED CONDUCTIVE GASKETS

## PART NUMBER CROSS REFERENCE

When ordering, please call our sales department to confirm availability and lead times.

### KNITTED CONDUCTIVE EMI GASKETS

PART NO.	PRODUCT	PAGE NO.
8101-01XX-40,41,47,48,49	ULTRAFLEX ELECTRONIT HOLLOW CORE ROUND	
8102-02XX-40,41,47,48,49	ULTRAFLEX D ELECTRONIT WITH PSA	
8103-01XX-40,41,47,48,49	ULTRAFLEX ELECTRONIT HOLLOW CORE ROUND WITH SINGLE FIN	
8104-01XX-40,41,47,48,49	ULTRAFLEX ELECTRONIT HOLLOW CORE DOUBLE ROUND	
8300-XXXX-40,42,43,44,46	ELECTROMESH TAPE	
8401-01XX-XX	ELECTRONIT ALL MESH RECTANGULAR STRIP	
8402-01XX-XX	ELECTRONIT ALL MESH ROUND STRIP	
8403-01XX-50,52,54,55,60,61	ELECTRONIT SINGLE FIN WITH SPONGE ELASTOMER	
8403-01XX-XX	ELECTRONIT ALL MESH SINGLE ROUND WITH FIN STRIP	
8404-01XX-XX	ELECTRONIT ALL MESH DOUBLE ROUND WITH FIN STRIP	
8405-01XX-50,52,54,55,60,61	ELECTRONIT ENVIRO-SEAL DOUBLE SHIELD STRIPS WITH PSA	
8406-01XX-50,52,54,55,60,61	ELECTRONIT ENVIRO-SEAL STRIPS WITH PSA	
8409-01XX-50,52,54,55,60,61	ELECTRONIT RECTANGULAR WITH SPONGE ELASTOMER	
8410-01XX-50,52,54,55,60,61	ELECTRONIT ROUND WITH SPONGE ELASTOMER	
8412-01XX-50,52,54,55,60,61	ELECTRONIT DOUBLE FIN WITH SPONGE ELASTOMER	
8413-01XX-56,64,65	ELECTRONIT ROUND WITH SILICONE ELASTOMER TUBING	
8414-01XX-56,64,65	ELECTRONIT SINGLE FIN WITH SILICONE ELASTOMER TUBING	
8415-01XX-56,64,65	ELECTRONIT DOUBLE FIN WITH SILICONE ELASTOMER TUBING	
843X-2XXX-X	ELECTRONIT SUPERSOFT	
8417-3XXX-62	ULTRASOFT KNIT GASKETS	
89XX-01XX-40,42,43,44,46	ELECTROGROUND EMI WASHERS	

# KNITTED CONDUCTIVE GASKETS

## ULTRAFLEX<sup>®</sup>

### SIZE VS. TOLERANCE: ULTRAFLEX HOLLOW CORE ROUND

Size Range	Tolerance	
	Diameter	
To 0.120 (3,1)	+ 0.020/- 0.000 (+0,5/-0,0)	
0.130 to 0.380 (3,3 to 9,7)	+ 0.030/- 0.000 (+0,8/-0,0)	
0.390 to 0.050 (9,9 to 12,7)	+ 0.046/- 0.000 (+1,2/-0,0)	
0.510 to 1.000 (13,0 to 25,4)	+ 0.062/- 0.000 (+1,6/-0,0)	

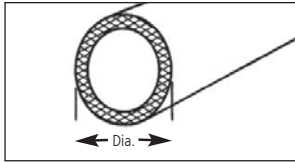

Groove Dimensions

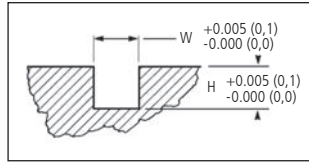

### SIZE VS. TOLERANCE: ULTRAFLEX HOLLOW CORE ROUND WITH SINGLE FIN

Size Range	Tolerance	
	Dim W	Dim H
To 0.180 (4,6)	N/A	+ 0.020/- 0.000 (+0,5/-0,0)
0.190 to 0.380 (4,8 to 9,7)	+ 0.060/- 0.030 (+1,5/-0,8)	+ 0.030/- 0.000 (+0,8/-0,0)
0.390 to 0.050 (9,9 to 12,7)	+ 0.060/- 0.060 (+1,5/-1,5)	+ 0.046/- 0.000 (+1,2/-0,0)
0.510 to 1.000 (13,0 to 25,4)	+ 0.090/- 0.060 (+2,3/-1,5)	+ 0.062/- 0.000 (+1,6/-0,0)

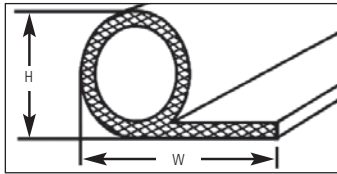

### SIZE VS. TOLERANCE: ULTRAFLEX HOLLOW CORE DOUBLE ROUND

Size Range	Tolerance	
	Dim W	Dim H
To 0.180 (4,6)	N/A	+ 0.020/- 0.000 (+0,5/-0,0)
0.190 to 0.380 (4,8 to 9,7)	+ 0.060/- 0.030 (+1,5/-0,8)	+ 0.030/- 0.000 (+0,8/-0,0)
0.390 to 0.050 (9,9 to 12,7)	+ 0.060/- 0.060 (+1,5/-1,5)	+ 0.046/- 0.000 (+1,2/-0,0)
0.510 to 1.000 (13,0 to 25,4)	+ 0.090/- 0.060 (+2,3/-1,5)	+ 0.062/- 0.000 (+1,6/-0,0)

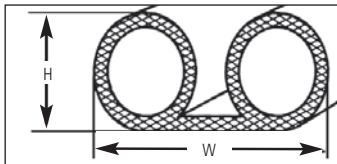

### SIZE VS. TOLERANCE: ULTRAFLEX D WITH PSA

Size Range	Tolerance	
	Dim W	Dim H
0.120 to 0.250 (3,1 to 6,4)	+ 0.030/- 0.000 (+0,8/-0,0)	+ 0.030/- 0.000 (+0,8/-0,0)
0.260 to 0.380 (6,6 to 9,7)	+ 0.040/- 0.000 (+1,0/-0,0)	+ 0.040/- 0.000 (+1,0/-0,0)
0.390 to 0.050 (9,9 to 12,7)	+ 0.050/- 0.000 (+1,3/-0,0)	+ 0.040/- 0.000 (+1,0/-0,0)

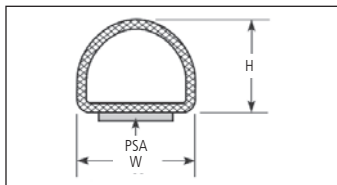

For Size vs. Tolerance charts, dimensions measured under 4 oz. load (11,3 gms) with 0.750 dia. (19,1 mm) anvil.

### ULTRAFLEX HOLLOW CORE ROUND

Laird Technologies Part No.	Groove Dimensions		Diameter
	W	H	
8101-0101-40	0.047 (1,2)	0.060 (1,5)	0.062 (1,6)
8101-0102-40	0.069 (1,8)	0.090 (2,3)	0.093 (2,4)
8101-0103-40	0.093 (2,4)	0.120 (3,1)	0.125 (3,2)
8101-0104-40	0.117 (3,0)	0.150 (3,8)	0.156 (4,0)
8101-0105-40	0.140 (3,6)	0.180 (4,6)	0.187 (4,8)
8101-0106-40	0.187 (4,8)	0.240 (6,1)	0.250 (6,4)
8101-0107-40	0.234 (5,9)	0.292 (7,4)	0.312 (7,9)
8101-0108-40	0.281 (7,1)	0.360 (9,1)	0.375 (9,5)
8101-0109-40	0.375 (9,5)	0.485 (12,3)	0.500 (12,7)
8101-0135-40	0.563 (14,3)	0.730 (18,5)	0.750 (19,1)

### ULTRAFLEX HOLLOW CORE ROUND WITH SINGLE FIN

Laird Technologies Part No.*	Width	Height
8103-0125-40	0.300 (7,6)	0.093 (2,4)
8103-0101-40	0.375 (9,5)	0.062 (1,6)
8103-0104-40	0.375 (9,5)	0.125 (3,2)
8103-0118-40	0.375 (9,5)	0.156 (4,0)
8103-0102-40	0.500 (12,7)	0.062 (1,6)
8103-0103-40	0.500 (12,7)	0.093 (2,4)
8103-0107-40	0.500 (12,7)	0.156 (4,0)
8103-0109-40	0.500 (12,7)	0.250 (6,4)
8103-0117-40	0.500 (12,7)	0.375 (9,5)
8103-0105-40	0.625 (15,9)	0.125 (3,2)
8103-0108-40	0.625 (15,9)	0.187 (4,8)
8103-0112-40	0.625 (15,9)	0.312 (7,9)
8103-0106-40	0.750 (19,1)	0.125 (3,2)
8103-0110-40	0.750 (19,1)	0.250 (6,4)
8103-0113-40	0.875 (22,2)	0.312 (7,9)
8103-0111-40	1.000 (25,4)	0.250 (6,4)
8103-0114-40	1.000 (25,4)	0.375 (9,5)
8103-0115-40	1.000 (25,4)	0.437 (11,1)
8103-0116-40	1.000 (25,4)	0.500 (12,7)

### ULTRAFLEX HOLLOW CORE DOUBLE ROUND

Laird Technologies Part No.*	Width	Height
8104-0101-40	0.500 (12,7)	0.062 (1,6)
8104-0102-40	0.500 (12,7)	0.125 (3,2)
8104-0105-40	0.625 (15,9)	0.187 (4,8)
8104-0103-40	0.750 (19,1)	0.125 (3,2)
8104-0107-40	0.750 (19,1)	0.250 (6,4)
8104-0104-40	1.000 (25,4)	0.125 (3,2)
8104-0106-40	1.000 (25,4)	0.187 (4,8)
8104-0108-40	1.000 (25,4)	0.250 (6,4)
8104-0109-40	1.000 (25,4)	0.375 (9,5)

### ULTRAFLEX D WITH PSA

Laird Technologies Part No.	Width	Height
8102-0202-40	0.200 (5,1)	0.130 (3,3)
8102-0209-40	0.250 (6,4)	0.125 (3,2)
8102-0203-40	0.250 (6,4)	0.190 (4,8)
8102-0204-40	0.312 (7,9)	0.250 (6,4)
8102-0205-40	0.380 (9,7)	0.312 (7,9)
8102-0206-40	0.500 (12,7)	0.375 (9,5)
8102-0207-40	0.750 (19,1)	0.670 (17,0)

For other platings, replace the suffix "40" as follows: **41**-Tin plate; **47**-Nickel plate; **48**-Cadmium plate; **49**-Zinc clear chromate. Other platings available upon request.

# KNITTED CONDUCTIVE GASKETS

## ALL MESH

### MATERIAL SPECIFICATIONS

Material Code	Wire Type	Specification
40	Beryllium Copper	ASTM B 197
42	Monel <sup>®</sup>	QQ N 281 Class A
43	Aluminum	5056 Alloy
44	Tin Plated Copper Clad Steel	ASTM B 520
46	Stainless Steel Alloy	SS304

### SIZE VS. TOLERANCE: ALL MESH SINGLE ROUND WITH FIN STRIP

Size Range	Tolerance	
	Dim W	Dim H
0.130 to 0.380 (3,3 to 9,7)	+ 0.060/- 0.030 (+1,5/-0,8)	+ 0.030/- 0.030 (+0,8/-0,8)
0.390 to 0.050 (9,9 to 12,7)	+ 0.060/- 0.060 (+1,5/-1,5)	+ 0.040/- 0.030 (+1,2/-0,8)
0.510 to 1.000 (13,0 to 25,4)	+ 0.090/- 0.060 (+2,3/-1,5)	+ 0.062/- 0.040 (+1,6/-1,0)

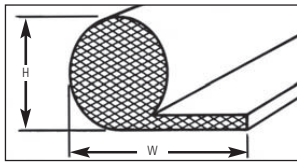

### SIZE VS. TOLERANCE: ALL MESH DOUBLE ROUND WITH FIN STRIP

Size Range	Tolerance	
	Dim W	Dim H
To 0.180 (4,6)	N/A	+ 0.020/- 0.000 (+0,5/-0,0)
0.190 to 0.380 (4,8 to 9,7)	+ 0.060/- 0.030 (+1,5/-0,8)	+ 0.030/- 0.030 (+0,8/-0,8)
0.390 to 0.050 (9,9 to 12,7)	+ 0.060/- 0.060 (+1,5/-1,5)	+ 0.040/- 0.030 (+1,2/-0,8)
0.510 to 1.000 (13,0 to 25,4)	+ 0.090/- 0.060 (+2,3/-1,5)	+ 0.062/- 0.040 (+1,6/-1,0)

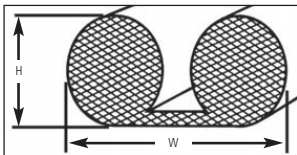

### SIZE VS. TOLERANCE: ALL MESH RECTANGULAR STRIP

Size Range	Tolerance	
	Dim W	Dim H
To 0.180 (4,6)	+ 0.020/- 0.000 (+0,5/-0,0)	+ 0.020/- 0.000 (+0,5/-0,0)
0.190 to 0.380 (4,8 to 9,7)	+ 0.030/- 0.000 (+0,8/-0,0)	+ 0.030/- 0.000 (+0,8/-0,0)
0.390 to 0.050 (9,9 to 12,7)	+ 0.046/- 0.000 (+1,2/-0,0)	+ 0.046/- 0.000 (+1,2/-0,0)
0.510 to 1.000 (13,0 to 25,4)	+ 0.062/- 0.000 (+1,6/-0,0)	+ 0.062/- 0.000 (+1,6/-0,0)

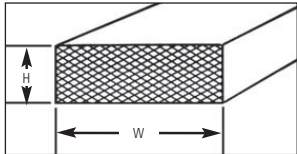

### SIZE VS. TOLERANCE: ALL MESH ROUND STRIP

Size Range	Tolerance
	Diameter
To 0.120 (3,1)	+ 0.020/- 0.000 (+0,5/-0,0)
0.130 to 0.380 (3,3 to 9,7)	+ 0.030/- 0.000 (+0,8/-0,0)
0.390 to 0.050 (9,9 to 12,7)	+ 0.046/- 0.000 (+1,2/-0,0)
0.510 to 1.000 (13,0 to 25,4)	+ 0.062/- 0.000 (+1,6/-0,0)

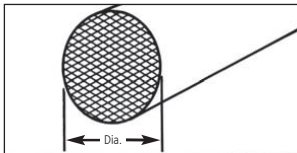

For Size vs. Tolerance charts, dimensions measured under 4 oz. load (11,3 gms) with 0.750 dia. (19,1 mm) anvil.

### ALL MESH SINGLE ROUND WITH FIN STRIP

Base Part No.*	Fin Portion Width	Round Portion Height	Base Part No.*	Fin Portion Width	Round Portion Height
8403-0101-XX	0.375 (9,5)	0.062 (1,8)	8403-0121-XX	0.750 (19,1)	0.187 (4,8)
8403-0104-XX	0.375 (9,5)	0.125 (3,2)	8403-0110-XX	0.750 (19,1)	0.250 (6,4)
8403-0102-XX	0.500 (12,7)	0.062 (1,8)	8403-0113-XX	0.875 (22,2)	0.312 (7,9)
8403-0103-XX	0.500 (12,7)	0.093 (2,4)	8403-0111-XX	1.000 (25,4)	0.250 (6,4)
8403-0107-XX	0.500 (12,7)	0.156 (4,0)	8403-0114-XX	1.000 (25,4)	0.375 (9,5)
8403-0109-XX	0.500 (12,7)	0.250 (6,4)	8403-0115-XX	1.000 (25,4)	0.437 (11,1)
8403-0105-XX	0.625 (15,9)	0.125 (3,2)	8403-0116-XX	1.000 (25,4)	0.500 (12,7)
8403-0108-XX	0.625 (15,9)	0.187 (4,8)	8403-0131-XX	1.500 (38,1)	0.375 (9,5)
8403-0112-XX	0.625 (15,9)	0.312 (7,9)	8403-0125-XX	1.500 (38,1)	0.500 (12,7)
8403-0106-XX	0.750 (19,1)	0.125 (3,2)			

### ALL MESH DOUBLE ROUND WITH FIN STRIP

Base Part No.*	Connecting Width	Round Height
8404-0101-XX	0.500 (12,7)	0.062 (1,6)
8404-0102-XX	0.500 (12,7)	0.125 (3,2)
8404-0105-XX	0.625 (15,9)	0.187 (4,8)
8404-0103-XX	0.750 (19,1)	0.125 (3,2)
8404-0107-XX	0.750 (19,1)	0.250 (6,4)
8404-0104-XX	1.000 (25,4)	0.125 (3,2)
8404-0106-XX	1.000 (25,4)	0.187 (4,8)
8404-0108-XX	1.000 (25,4)	0.250 (6,4)
8404-0109-XX	1.000 (25,4)	0.375 (9,5)
8404-0115-XX	1.250 (31,8)	0.250 (6,4)
8404-0124-XX	1.500 (38,1)	0.375 (9,5)
8404-0120-XX	1.500 (38,1)	0.500 (12,7)
8404-0121-XX	2.000 (50,8)	0.375 (9,5)
8404-0118-XX	2.000 (50,8)	0.500 (12,7)
8404-0122-XX	2.500 (63,5)	0.500 (12,7)

### ALL MESH RECTANGULAR STRIP

Base Part No.*	Width W	Height H	Base Part No.*	Width W	Height H
8401-0101-XX	0.062 (1,8)	0.062 (1,6)	8401-0123-XX	0.250 (6,4)	0.250 (6,4)
8401-0134-XX	0.093 (2,4)	0.062 (1,8)	8401-0104-XX	0.312 (7,9)	0.062 (1,6)
8401-0107-XX	0.093 (2,4)	0.093 (2,4)	8401-0115-XX	0.312 (7,9)	0.125 (3,2)
8401-0102-XX	0.125 (3,2)	0.062 (1,6)	8401-0122-XX	0.312 (7,9)	0.187 (4,8)
8401-0108-XX	0.125 (3,2)	0.093 (2,4)	8401-0124-XX	0.312 (7,9)	0.250 (6,4)
8401-0112-XX	0.125 (3,2)	0.125 (3,2)	8401-0105-XX	0.375 (9,5)	0.062 (1,6)
8401-0137-XX	0.156 (4,0)	0.062 (1,8)	8401-0111-XX	0.375 (9,5)	0.093 (2,4)
8401-0129-XX	0.156 (4,0)	0.125 (3,2)	8401-0116-XX	0.375 (9,5)	0.125 (3,2)
8401-0142-XX	0.156 (4,0)	0.156 (4,0)	8401-0125-XX	0.375 (9,5)	0.250 (6,4)
8401-0103-XX	0.187 (4,8)	0.062 (1,6)	8401-0127-XX	0.375 (9,5)	0.375 (9,5)
8401-0109-XX	0.187 (4,8)	0.093 (2,4)	8401-0106-XX	0.500 (12,7)	0.062 (1,6)
8401-0113-XX	0.187 (4,8)	0.125 (3,2)	8401-0117-XX	0.500 (12,7)	0.125 (3,2)
8401-0120-XX	0.187 (4,8)	0.187 (4,8)	8401-0133-XX	0.500 (12,7)	0.187 (4,8)
8401-0131-XX	0.218 (5,5)	0.156 (4,0)	8401-0126-XX	0.500 (12,7)	0.250 (6,4)
8401-0155-XX	0.250 (6,4)	0.062 (1,8)	8401-0118-XX	0.750 (19,1)	0.125 (3,2)
8401-0110-XX	0.250 (6,4)	0.093 (2,4)	8401-144-XX	0.750 (19,1)	0.187 (4,8)
8401-0114-XX	0.250 (6,4)	0.125 (3,2)	8401-0119-XX	1.000 (25,4)	0.125 (3,2)
8401-0121-XX	0.250 (6,4)	0.187 (4,8)			

### ALL MESH ROUND STRIP

Base Part No.	Diameter	Base Part No.	Diameter
8402-0101-XX	0.062 (1,6)	8402-0106-XX	0.250 (6,4)
8402-0102-XX	0.093 (2,4)	8402-0107-XX	0.312 (7,9)
8402-0103-XX	0.125 (3,2)	8402-0108-XX	0.375 (9,5)
8402-0104-XX	0.156 (4,0)	8402-0109-XX	0.500 (12,7)
8402-0105-XX	0.187 (4,8)		

All dimensions shown are in inches (millimeters) unless otherwise specified.



# KNITTED CONDUCTIVE GASKETS ELASTOMER CORE

## MATERIAL SPECIFICATIONS

	Description	Specification
Wire Type	Beryllium Copper	ASTM B 197
	Monel <sup>®</sup>	QQ N 281 Class A
	Tin Plated Copper Clad Steel	ASTM B 520
Elastomer Type	Neoprene Sponge	MIL-R-6130 Type II, Grade A (Closed Cell) Conditioned Medium; Temp. Range -24°F to 212°F (-31,1°C to 100°C)
	Silicone Sponge	AMS 3195 (Closed Cell); Temp. Range -103°F to 400°F (-75°C to 204°C)
	Silicone Solid	ZZ-R-765, Class 2, Grade 50; Temp. Range -80°F to 500°F (-62,2°C to 260°C)

## SIZE VS. TOLERANCE: RECTANGULAR WITH SPONGE ELASTOMER

Size Range	Tolerance	
	Width	Height
To 0.120 (3,1)	+ 0.030/- 0.020 (+0,8/-0,5)	+ 0.030/- 0.020 (+0,8/-0,5)
0.130 to 0.380 (3,3 to 9,7)	± 0.030 (±0,8)	± 0.030 (±0,8)
0.390 to 0.050 (9,9 to 12,7)	± 0.046 (±1,2)	± 0.046 (±1,2)
0.510 to 1.000 (13,0 to 25,4)	± 0.062 (±1,6)	± 0.062 (±1,6)

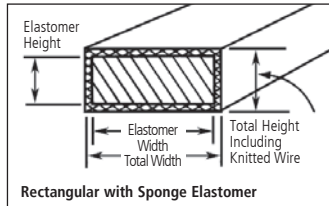

## RECTANGULAR WITH SPONGE ELASTOMER

Laird Technologies Part No.*	Elastomer Width	Elastomer Height	Total Width	Total Height
8409-0101-50	0.125 (3,2)	0.125 (3,2)	0.160 (4,1)	0.160 (4,1)
8409-0102-50	0.188 (4,8)	0.125 (3,2)	0.225 (5,7)	0.160 (4,1)
8409-0104-50	0.188 (4,8)	0.188 (4,8)	0.225 (5,7)	0.225 (5,7)
8409-0130-50	0.250 (6,4)	0.062 (1,6)	0.270 (6,9)	0.082 (2,1)
8409-0103-50	0.250 (6,4)	0.125 (3,2)	0.285 (7,2)	0.160 (4,1)
8409-0105-50	0.250 (6,4)	0.250 (6,4)	0.285 (7,2)	0.285 (7,2)
8409-0125-50	0.375 (9,5)	0.125 (3,2)	0.410 (10,4)	0.160 (4,1)
8409-0166-50	0.375 (9,5)	0.250 (6,4)	0.410 (10,4)	0.285 (7,2)
8409-0126-50	0.375 (9,5)	0.375 (9,5)	0.405 (10,3)	0.405 (10,3)
8409-0158-50	0.500 (12,7)	0.125 (3,2)	0.518 (13,2)	0.143 (3,6)
8409-0106-50	0.500 (12,7)	0.250 (6,4)	0.535 (13,6)	0.285 (7,2)
8409-0132-50	0.500 (12,7)	0.250 (6,4)	0.535 (13,6)	0.285 (7,2)
8409-0161-50	0.500 (12,7)	0.312 (7,9)	0.540 (13,7)	0.352 (8,9)
8409-0117-50	0.500 (12,7)	0.500 (12,7)	0.535 (13,6)	0.535 (13,6)
8409-0176-50	0.750 (19,1)	0.250 (6,4)	0.785 (19,9)	0.285 (7,2)
8409-0168-50	1.000 (25,4)	0.250 (6,4)	1.035 (26,3)	0.285 (7,2)
8409-0173-50	1.250 (31,8)	0.500 (12,7)	1.272 (32,3)	0.567 (14,4)

The suffix "50" is BeCu neoprene sponge. For other materials, replace the suffix "50" as follows: **54**-Neoprene sponge and Monel; **52**-Silicone sponge and beryllium copper; **55**-Silicone sponge and Monel; **60**-Neoprene sponge and tin plated copper clad steel; **61**-Silicone sponge and tin plated copper clad steel.

## SIZE VS. TOLERANCE: ROUND WITH SPONGE AND SILICONE

Size Range	Tolerance
	O.D.
To 0.120 (3,1)	± 0.020 (±0,5)
0.130 to 0.380 (3,3 to 9,7)	± 0.030 (±0,8)
0.390 to 0.050 (9,9 to 12,7)	+ 0.040/-0.030 (+1,0/-0,8)
0.510 to 1.000 (13,0 to 25,4)	+ 0.062/-0.040 (+1,6/-1,0)

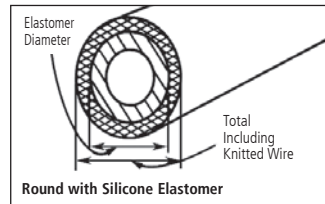
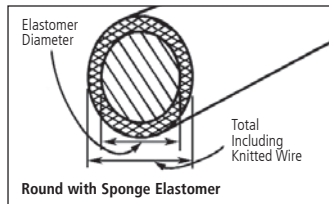

## ROUND WITH SPONGE ELASTOMER

Laird Technologies Part No.	Elastomer Diameter	Total Diameter Over Wire	Laird Technologies Tubing Part No.	Tubing Diameter (O.D.)	Diameter Over Wire
8410-0101-50**	0.062 (1,6)	0.098 (2,5)	8413-0101-64	0.125 (3,2)	0.160 (4,1)
8410-0102-50	0.125 (3,2)	0.160 (4,1)	8413-0102-64	0.188 (4,8)	0.225 (5,7)
8410-0103-50	0.188 (4,8)	0.225 (5,7)	8413-0103-64	0.250 (6,4)	0.285 (7,2)
8410-0104-50	0.250 (6,4)	0.285 (7,2)	8413-0104-64	0.312 (7,9)	0.348 (8,8)
8410-0105-50	0.312 (7,9)	0.348 (8,8)	8413-0114-64	0.375 (9,5)	0.383 (9,7)
8410-0106-50	0.375 (9,5)	0.410 (10,4)	8413-0105-64	0.375 (9,5)	0.410 (10,4)
8410-0107-50	0.500 (12,7)	0.535 (13,6)	8413-0106-64	0.500 (12,7)	0.535 (13,6)

The suffix "50" is BeCu neoprene sponge. For other materials, replace the suffix "50" as follows: **54**-Neoprene sponge and Monel; **52**-Silicone sponge and beryllium copper; **55**-Silicone sponge and Monel; **60**-Neoprene sponge and tin plated copper clad steel; **61**-Silicone sponge and tin plated copper clad steel.

**\*\*Not available in Neoprene sponge.**

## ROUND WITH SILICONE ELASTOMER TUBING

The suffix "64" is BeCu with silicone elastomer tubing. For other materials, replace the suffix "64" as follows: **56**-Silicone elastomer tubing with Monel; **65**-Silicone elastomer tubing with tin plated copper clad steel.

# KNITTED CONDUCTIVE GASKETS ELASTOMER CORE

## SIZE VS. TOLERANCE: SINGLE FIN WITH SPONGE ELASTOMER

Size Range	Tolerance	
	Width	Height
0.130 to 0.380 (3,3 to 9,7)	± 0.030 (±0,8)	+ 0.060/-0.030 (+1,5/-0,8)
0.390 to 0.050 (9,9 to 12,7)	+ 0.040/- 0.030 (+1,0/-0,8)	± 0.060 (±1,5)
0.510 to 1.000 (13,0 to 25,4)	+ 0.062/- 0.040 (+1,6/-1,0)	+ 0.090/-0.060 (+2,3/-1,5)

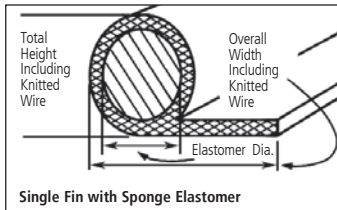

## SIZE VS. TOLERANCE: DOUBLE FIN WITH SPONGE ELASTOMER

Size Range	Tolerance	
	Width	Height
0.130 to 0.380 (3,3 to 9,7)	± 0.030 (±0,8)	+ 0.060/- 0.030 (+1,5/-0,8)
0.390 to 0.050 (9,9 to 12,7)	+ 0.040/- 0.030 (+1,0/-0,8)	± 0.060 (±1,5)
0.510 to 1.000 (13,0 to 25,4)	+ 0.062/- 0.040 (+1,6/-1,0)	+ 0.090/- 0.060 (+2,3/-1,5)

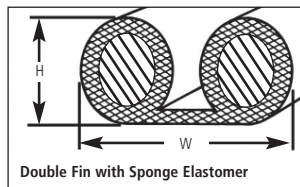

For Size vs. Tolerance charts, dimensions measured under 4 oz. load (11,3 gms) with 0.750 dia. (19,1 mm) anvil.

## SIZE VS. TOLERANCE: SINGLE FIN WITH SILICONE ELASTOMER TUBING

Size Range	Tolerance	
	Width	Height
0.130 to 0.380 (3,3 to 9,7)	± 0.030 (±0,8)	+ 0.060/- 0.030 (+1,5/-0,8)
0.390 to 0.050 (9,9 to 12,7)	+ 0.040/- 0.030 (+1,0/-0,8)	± 0.060 (±1,5)
0.510 to 1.000 (13,0 to 25,4)	+ 0.062/- 0.040 (+1,6/-1,0)	+ 0.090/- 0.060 (+2,3/-1,5)

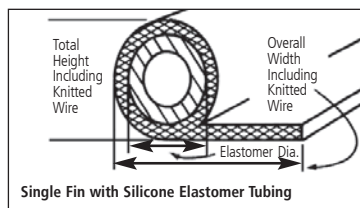

For Size vs. Tolerance charts, dimensions measured under 4 oz. load (11,3 gms) with 0.750 dia. (19,1 mm) anvil.

## SIZE VS. TOLERANCE: DOUBLE FIN WITH SILICONE ELASTOMER TUBING

Size Range	Tolerance	
	Width	Height
0.130 to 0.380 (3,3 to 9,7)	± 0.030 (±0,8)	+ 0.060/- 0.030 (+1,5/-0,8)
0.390 to 0.050 (9,9 to 12,7)	+ 0.040/- 0.030 (+1,0/-0,8)	± 0.060 (±1,5)
0.510 to 1.000 (13,0 to 25,4)	+ 0.062/- 0.040 (+1,6/-1,0)	+ 0.090/- 0.060 (+2,3/-1,5)

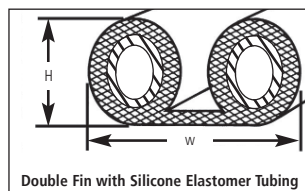

For Size vs. Tolerance charts, dimensions measured under 4 oz. load (11,3 gms) with 0.750 dia. (19,1 mm) anvil.

## SINGLE FIN WITH SPONGE ELASTOMER

Laird Technologies Part No.*	Elastomer Diameter	Overall Width	Total Height
8403-0101-50	0.125 (3,2)	0.500 (12,7)	0.160 (4,1)
8403-0102-50	0.125 (3,2)	0.750 (19,1)	0.160 (4,1)
8403-0103-50	0.188 (4,8)	0.625 (15,9)	0.225 (5,7)
8403-0104-50	0.188 (4,8)	0.750 (19,1)	0.225 (5,7)
8403-0105-50	0.250 (6,4)	0.750 (19,1)	0.285 (7,2)
8403-0106-50	0.250 (6,4)	1.000 (25,4)	0.285 (7,2)
8403-0107-50	0.500 (12,7)	1.000 (25,4)	0.535 (13,6)

The suffix "50" is BeCu neoprene sponge. For other materials, replace the suffix "50" as follows: **54**-Neoprene sponge and Monel; **52**-Silicone sponge and beryllium copper; **55**-Silicone sponge and Monel; **60**- Neoprene sponge and tin plated copper clad steel; **61**-Silicone sponge and tin plated copper clad steel.

\* For part number ordering information on pressure-sensitive adhesive tape see page 1.4.

## DOUBLE FIN WITH SPONGE ELASTOMER

Laird Technologies Part No.*	Elastomer Diameter	Overall Width	Total Height
8412-0101-50	0.125 (3,2)	0.500 (12,7)	0.160 (4,1)
8412-0102-50	0.125 (3,2)	0.750 (19,1)	0.160 (4,1)
8412-0103-50	0.188 (4,8)	0.625 (15,9)	0.225 (5,7)
8412-0104-50	0.188 (4,8)	0.750 (19,1)	0.225 (5,7)
8412-0105-50	0.250 (6,4)	1.000 (25,4)	0.285 (7,2)
8412-0107-50	0.500 (12,7)	1.312 (33,3)	0.535 (13,6)

The suffix "50" is BeCu neoprene sponge. For other materials, replace the suffix "50" as follows: **54**-Neoprene sponge and Monel; **52**-Silicone sponge and beryllium copper; **55**-Silicone sponge and Monel; **60**- Neoprene sponge and tin plated copper clad steel; **61**-Silicone sponge and tin plated copper clad steel.

## SINGLE FIN WITH SILICONE ELASTOMER TUBING

Laird Technologies Part No.*	Tubing Diameter (O.D.)	Overall Width	Total Height Over Wire
8414-0101-64	0.125 (3,2)	0.500 (12,7)	0.160 (4,1)
8414-0102-64		0.750 (19,1)	
8414-0103-64	0.188 (4,8)	0.625 (15,9)	0.225 (5,7)
8414-0104-64		0.750 (19,1)	
8414-0105-64	0.250 (6,6)	0.750 (19,1)	0.285 (7,2)
8414-0106-64		1.000 (25,4)	
8414-0107-64	0.312 (7,9)	0.625 (15,9)	0.348 (8,8)
8414-0108-64		1.000 (25,4)	
8414-0109-64	0.375 (9,5)	0.750 (19,1)	0.410 (10,4)
8414-0110-64		1.120 (28,5)	
8414-0111-64	0.500 (12,7)	1.000 (25,4)	0.535 (13,6)
8414-0112-64		1.250 (31,8)	

The suffix "64" is BeCu with silicone elastomer tubing. For other materials, replace the suffix "64" as follows: **56**-Silicone elastomer tubing with Monel; **65**-Silicone elastomer tubing with tin plated copper clad steel.

## DOUBLE FIN WITH SILICONE ELASTOMER TUBING

Laird Technologies Part No.*	Tubing Diameter (O.D.)	Overall Width	Total Height Over Wire
8415-0101-64	0.125 (3,2)	0.500 (12,7)	0.160 (4,1)
8415-0102-64		0.750 (19,1)	
8415-0103-64	0.188 (4,8)	0.625 (15,9)	0.225 (5,7)
8415-0104-64		0.750 (19,1)	
8415-0105-64	0.250 (6,4)	0.750 (19,1)	0.285 (7,2)
8415-0106-64		1.000 (25,4)	
8415-0108-64	0.312 (7,9)	1.000 (25,4)	0.348 (8,8)
8415-0110-64		1.120 (28,5)	
8415-0112-64	0.500 (12,7)	1.250 (31,8)	0.535 (13,6)

The suffix "64" is BeCu with silicone elastomer tubing. For other materials, replace the suffix "64" as follows: **56**-Silicone elastomer tubing with Monel; **65**-Silicone elastomer tubing with tin plated copper clad steel.

All dimensions shown are in inches (millimeters) unless otherwise specified.

# KNITTED CONDUCTIVE GASKETS

## ELECTROGROUND<sup>®</sup> EMI WASHERS

FIGURE 5. ELECTROGROUND WASHER DIMENSIONS

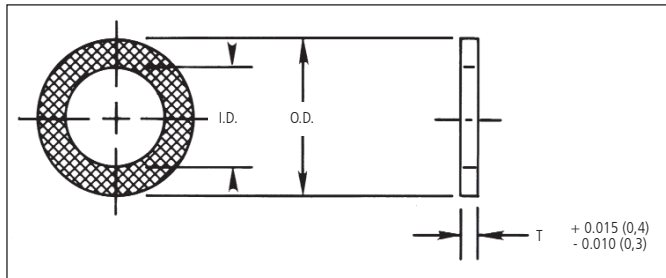

### ELECTROGROUND WASHER SIZES, MATERIALS AND TOLERANCES

TABLE 1. DIMENSIONS

Laird Technologies Part No.	O.D.	I.D.	Free Height Maximum "T"
8904-0178-XX	0.200 (5,1)	0.125 (3,2)	0.032 (0,8)
8905-0178-XX	0.200 (5,1)	0.125 (3,2)	0.062 (1,6)
8906-0178-XX	0.200 (5,1)	0.125 (3,2)	0.093 (2,4)
8907-0178-XX	0.200 (5,1)	0.125 (3,2)	0.125 (3,2)
8908-0178-XX	0.200 (5,1)	0.125 (3,2)	0.156 (4,0)
8909-0178-XX	0.200 (5,1)	0.125 (3,2)	0.187 (4,7)
8910-0178-XX	0.200 (5,1)	0.125 (3,2)	0.250 (6,4)
8904-0107-XX	0.223 (5,7)	0.052 (1,3)	0.032 (0,8)
8902-0107-XX	0.223 (5,7)	0.052 (1,3)	0.062 (1,6)
8905-0107-XX	0.223 (5,7)	0.052 (1,3)	0.093 (2,4)
8901-0107-XX	0.223 (5,7)	0.052 (1,3)	0.125 (3,2)
8906-0107-XX	0.223 (5,7)	0.052 (1,3)	0.156 (4,0)
8907-0107-XX	0.223 (5,7)	0.052 (1,3)	0.187 (4,7)
8908-0107-XX	0.223 (5,7)	0.052 (1,3)	0.250 (6,4)
8902-0109-XX	0.225 (5,7)	0.120 (3,0)	0.032 (0,8)
8904-0109-XX	0.225 (5,7)	0.120 (3,0)	0.062 (1,6)
8905-0109-XX	0.225 (5,7)	0.120 (3,0)	0.093 (2,4)
8906-0109-XX	0.225 (5,7)	0.120 (3,0)	0.125 (3,2)
8907-0109-XX	0.225 (5,7)	0.120 (3,0)	0.156 (4,0)
8903-0109-XX	0.225 (5,7)	0.120 (3,0)	0.187 (4,7)
8908-0109-XX	0.225 (5,7)	0.120 (3,0)	0.250 (6,4)
8902-0118-XX	0.255 (6,5)	0.150 (3,8)	0.032 (0,8)
8906-0118-XX	0.255 (6,5)	0.150 (3,8)	0.062 (1,6)
8907-0118-XX	0.255 (6,5)	0.150 (3,8)	0.093 (2,4)
8904-0118-XX	0.255 (6,5)	0.150 (3,8)	0.125 (3,2)
8908-0118-XX	0.255 (6,5)	0.150 (3,8)	0.156 (4,0)
8901-0118-XX	0.255 (6,5)	0.150 (3,8)	0.187 (4,7)
8909-0118-XX	0.255 (6,5)	0.150 (3,8)	0.250 (6,4)
8902-0116-XX	0.375 (9,5)	0.240 (6,1)	0.032 (0,8)
8903-0116-XX	0.375 (9,5)	0.240 (6,1)	0.062 (1,6)

TABLE 1. DIMENSIONS (CONTINUED)

Laird Technologies Part No.	O.D.	I.D.	Free Height Maximum "T"
8901-0116-XX	0.375 (9,5)	0.240 (6,1)	0.093 (2,4)
8904-0116-XX	0.375 (9,5)	0.240 (6,1)	0.125 (3,2)
8905-0116-XX	0.375 (9,5)	0.240 (6,1)	0.156 (4,0)
8906-0116-XX	0.375 (9,5)	0.240 (6,1)	0.187 (4,7)
8907-0116-XX	0.375 (9,5)	0.240 (6,1)	0.250 (6,4)
8901-0117-XX	0.375 (9,5)	0.187 (4,8)	0.032 (0,8)
8905-0117-XX	0.375 (9,5)	0.187 (4,8)	0.062 (1,6)
8903-0117-XX	0.375 (9,5)	0.187 (4,8)	0.093 (2,4)
8902-0117-XX	0.375 (9,5)	0.187 (4,8)	0.125 (3,2)
8911-0117-XX	0.375 (9,5)	0.187 (4,8)	0.156 (4,0)
8912-0117-XX	0.375 (9,5)	0.187 (4,8)	0.187 (4,7)
8904-0117-XX	0.375 (9,5)	0.187 (4,8)	0.250 (6,4)
8909-0102-XX	0.459 (11,7)	0.335 (8,5)	0.032 (0,8)
8901-0102-XX	0.459 (11,7)	0.335 (8,5)	0.062 (1,6)
8910-0102-XX	0.459 (11,7)	0.335 (8,5)	0.093 (2,4)
8902-0102-XX	0.459 (11,7)	0.335 (8,5)	0.125 (3,3)
8911-0102-XX	0.459 (11,7)	0.335 (8,5)	0.156 (4,0)
8912-0102-XX	0.459 (11,7)	0.335 (8,5)	0.187 (4,7)
8905-0102-XX	0.459 (11,7)	0.335 (8,5)	0.250 (6,4)
8902-0110-XX	0.500 (12,7)	0.172 (4,4)	0.032 (0,8)
8903-0110-XX	0.500 (12,7)	0.172 (4,4)	0.062 (1,6)
8904-0110-XX	0.500 (12,7)	0.172 (4,4)	0.093 (2,4)
8901-0110-XX	0.500 (12,7)	0.172 (4,4)	0.125 (3,2)
8905-0110-XX	0.500 (12,7)	0.172 (4,4)	0.156 (4,0)
8906-0110-XX	0.500 (12,7)	0.172 (4,4)	0.187 (4,7)
8907-0110-XX	0.500 (12,7)	0.172 (4,4)	0.250 (6,4)
8907-0101-XX	0.500 (12,7)	0.212 (5,4)	0.032 (0,8)
8904-0101-XX	0.500 (12,7)	0.212 (5,4)	0.062 (1,6)
8901-0101-XX	0.500 (12,7)	0.212 (5,4)	0.093 (2,4)
8906-0101-XX	0.500 (12,7)	0.212 (5,4)	0.125 (3,2)
8908-0101-XX	0.500 (12,7)	0.212 (5,4)	0.156 (4,0)
8909-0101-XX	0.500 (12,7)	0.212 (5,4)	0.187 (4,7)
8902-0101-XX	0.500 (12,7)	0.212 (5,4)	0.250 (6,4)
8908-0122-XX	0.500 (12,7)	0.240 (6,1)	0.032 (0,8)
8909-0122-XX	0.500 (12,7)	0.240 (6,1)	0.062 (1,6)
8910-0122-XX	0.500 (12,7)	0.240 (6,1)	0.093 (2,4)
8903-0122-XX	0.500 (12,7)	0.240 (6,1)	0.125 (3,2)
8911-0122-XX	0.500 (12,7)	0.240 (6,1)	0.156 (4,0)
8912-0122-XX	0.500 (12,7)	0.240 (6,1)	0.187 (4,7)
8902-0122-XX	0.500 (12,7)	0.240 (6,1)	0.250 (6,4)
8904-0105-XX	0.500 (12,7)	0.312 (7,9)	0.032 (0,8)
8918-0105-XX	0.500 (12,7)	0.312 (7,9)	0.062 (1,6)
8919-0105-XX	0.500 (12,7)	0.312 (7,9)	0.093 (2,4)
8909-0105-XX	0.500 (12,7)	0.312 (7,9)	0.125 (3,2)
8903-0105-XX	0.500 (12,7)	0.312 (7,9)	0.156 (4,0)
8920-0105-XX	0.500 (12,7)	0.312 (7,9)	0.187 (4,7)
8910-0105-XX	0.500 (12,7)	0.312 (7,9)	0.250 (6,4)
8902-0108-XX	0.500 (12,7)	0.375 (9,5)	0.032 (0,8)
8907-0108-XX	0.500 (12,7)	0.375 (9,5)	0.062 (1,6)
8908-0108-XX	0.500 (12,7)	0.375 (9,5)	0.093 (2,4)
8909-0108-XX	0.500 (12,7)	0.375 (9,5)	0.125 (3,2)
8910-0108-XX	0.500 (12,7)	0.375 (9,5)	0.156 (4,0)
8906-0108-XX	0.500 (12,7)	0.375 (9,5)	0.187 (4,7)
8911-0108-XX	0.500 (12,7)	0.375 (9,5)	0.250 (6,4)

All dimensions shown are in inches (millimeters) unless otherwise specified.

# KNITTED CONDUCTIVE GASKETS ELECTROGROUND® EMI WASHERS

TABLE 1. DIMENSIONS (continued)

Laird Technologies Part No.	O.D.	I.D.	Free Height Maximum "T"
8908-0125-XX	0.525 (13,3)	0.355 (9,0)	0.032 (0,8)
8909-0125-XX	0.525 (13,3)	0.355 (9,0)	0.062 (1,6)
8904-0125-XX	0.525 (13,3)	0.355 (9,0)	0.093 (2,4)
8910-0125-XX	0.525 (13,3)	0.355 (9,0)	0.125 (3,2)
8911-0125-XX	0.525 (13,3)	0.355 (9,0)	0.156 (4,0)
8912-0125-XX	0.525 (13,3)	0.355 (9,0)	0.187 (4,8)
8903-0125-XX	0.525 (13,3)	0.355 (9,0)	0.250 (6,4)
8902-0129-XX	0.625 (15,9)	0.250 (6,4)	0.032 (0,8)
8903-0129-XX	0.625 (15,9)	0.250 (6,4)	0.062 (1,6)
8904-0129-XX	0.625 (15,9)	0.250 (6,4)	0.093 (2,4)
8905-0129-XX	0.625 (15,9)	0.250 (6,4)	0.125 (3,2)
8906-0129-XX	0.625 (15,9)	0.250 (6,4)	0.156 (4,0)
8907-0129-XX	0.625 (15,9)	0.250 (6,4)	0.187 (4,7)
8908-0129-XX	0.625 (15,9)	0.250 (6,4)	0.250 (6,4)
8911-0130-XX	0.625 (15,9)	0.370 (9,4)	0.032 (0,8)
8914-0130-XX	0.625 (15,9)	0.370 (9,4)	0.062 (1,6)
8913-0130-XX	0.625 (15,9)	0.370 (9,4)	0.093 (2,4)
8915-0130-XX	0.625 (15,9)	0.370 (9,4)	0.125 (3,2)
8901-0130-XX	0.625 (15,9)	0.370 (9,4)	0.156 (4,0)
8917-0130-XX	0.625 (15,9)	0.370 (9,4)	0.187 (4,7)
8904-0130-XX	0.625 (15,9)	0.370 (9,4)	0.250 (6,4)
8903-0180-XX	0.625 (15,9)	0.460 (11,7)	0.032 (0,8)
8904-0180-XX	0.625 (15,9)	0.460 (11,7)	0.062 (1,6)
8905-0180-XX	0.625 (15,9)	0.460 (11,7)	0.093 (2,4)
8906-0180-XX	0.625 (15,9)	0.460 (11,7)	0.125 (3,2)
8907-0180-XX	0.625 (15,9)	0.460 (11,7)	0.156 (4,0)
8901-0180-XX	0.625 (15,9)	0.460 (11,7)	0.187 (4,7)
8908-0180-XX	0.625 (15,9)	0.460 (11,7)	0.250 (6,4)
8903-0135-XX	0.625 (15,9)	0.490 (12,4)	0.032 (0,8)
8918-0135-XX	0.625 (15,9)	0.490 (12,4)	0.062 (1,6)
8919-0135-XX	0.625 (15,9)	0.490 (12,4)	0.093 (2,4)
8911-0135-XX	0.625 (15,9)	0.490 (12,4)	0.125 (3,2)
8916-0135-XX	0.625 (15,9)	0.490 (12,4)	0.156 (4,0)
8902-0135-XX	0.625 (15,9)	0.490 (12,4)	0.187 (4,7)
8906-0135-XX	0.625 (15,9)	0.490 (12,4)	0.250 (6,4)
8902-0137-XX	0.689 (17,5)	0.374 (9,5)	0.032 (0,8)
8903-0137-XX	0.689 (17,5)	0.374 (9,5)	0.062 (1,6)
8904-0137-XX	0.689 (17,5)	0.374 (9,5)	0.093 (2,4)
8905-0137-XX	0.689 (17,5)	0.374 (9,5)	0.125 (3,2)
8901-0137-XX	0.689 (17,5)	0.374 (9,5)	0.156 (4,0)
8906-0137-XX	0.689 (17,5)	0.374 (9,5)	0.187 (4,7)
8907-0137-XX	0.689 (17,5)	0.374 (9,5)	0.250 (6,4)
8903-0177-XX	0.750 (19,1)	0.187 (4,7)	0.032 (0,8)
8901-0177-XX	0.750 (19,1)	0.187 (4,7)	0.062 (1,6)
8904-0177-XX	0.750 (19,1)	0.187 (4,7)	0.093 (2,4)
8905-0177-XX	0.750 (19,1)	0.187 (4,7)	0.125 (3,2)
8906-0177-XX	0.750 (19,1)	0.187 (4,7)	0.156 (4,0)
8907-0177-XX	0.750 (19,1)	0.187 (4,7)	0.187 (4,7)
8908-0177-XX	0.750 (19,1)	0.187 (4,7)	0.250 (6,4)
8910-0140-XX	0.750 (19,1)	0.490 (12,4)	0.032 (0,8)
8907-0140-XX	0.750 (19,1)	0.490 (12,4)	0.062 (1,6)
8911-0140-XX	0.750 (19,1)	0.490 (12,4)	0.093 (2,4)
8912-0140-XX	0.750 (19,1)	0.490 (12,4)	0.125 (3,2)
8913-0140-XX	0.750 (19,1)	0.490 (12,4)	0.156 (4,0)
8901-0140-XX	0.750 (19,1)	0.490 (12,4)	0.187 (4,7)
8902-0140-XX	0.750 (19,1)	0.490 (12,4)	0.250 (6,4)

TABLE 1. DIMENSIONS (continued)

Laird Technologies Part No.	O.D.	I.D.	Free Height Maximum "T"
8903-0145-XX	0.800 (20,3)	0.650 (16,5)	0.032 (0,8)
8909-0145-XX	0.800 (20,3)	0.650 (16,5)	0.062 (1,6)
8911-0145-XX	0.800 (20,3)	0.650 (16,5)	0.093 (2,4)
8906-0145-XX	0.800 (20,3)	0.650 (16,5)	0.125 (3,2)
8911-0145-XX	0.800 (20,3)	0.650 (16,5)	0.156 (4,0)
8912-0145-XX	0.800 (20,3)	0.650 (16,5)	0.187 (4,7)
8904-0145-XX	0.800 (20,3)	0.650 (16,5)	0.250 (6,4)
8912-0150-XX	1.000 (25,4)	0.750 (19,1)	0.032 (0,8)
8913-0150-XX	1.000 (25,4)	0.750 (19,1)	0.062 (1,6)
8914-0150-XX	1.000 (25,4)	0.750 (19,1)	0.093 (2,4)
8915-0150-XX	1.000 (25,4)	0.750 (19,1)	0.125 (3,2)
8916-0150-XX	1.000 (25,4)	0.750 (19,1)	0.156 (4,0)
8903-0150-XX	1.000 (25,4)	0.750 (19,1)	0.187 (4,7)
8902-0150-XX	1.000 (25,4)	0.750 (19,1)	0.250 (6,4)
8904-0157-XX	1.140 (29,0)	0.826 (21,0)	0.032 (0,8)
8903-0157-XX	1.140 (29,0)	0.826 (21,0)	0.062 (1,6)
8905-0157-XX	1.140 (29,0)	0.826 (21,0)	0.093 (2,4)
8906-0157-XX	1.140 (29,0)	0.826 (21,0)	0.125 (3,2)
8907-0157-XX	1.140 (29,0)	0.826 (21,0)	0.156 (4,0)
8908-0157-XX	1.140 (29,0)	0.826 (21,0)	0.187 (4,7)
8909-0157-XX	1.140 (29,0)	0.826 (21,0)	0.250 (6,4)
8902-0156-XX	1.250 (31,8)	1.000 (25,4)	0.032 (0,8)
8903-0156-XX	1.250 (31,8)	1.000 (25,4)	0.062 (1,6)
8904-0156-XX	1.250 (31,8)	1.000 (25,4)	0.093 (2,4)
8905-0156-XX	1.250 (31,8)	1.000 (25,4)	0.125 (3,2)
8906-0156-XX	1.250 (31,8)	1.000 (25,4)	0.156 (4,0)
8907-0156-XX	1.250 (31,8)	1.000 (25,4)	0.187 (4,7)
8901-0156-XX	1.250 (31,8)	1.000 (25,4)	0.250 (6,4)
8902-0171-XX	1.254 (31,9)	1.114 (28,3)	0.032 (0,8)
8903-0171-XX	1.254 (31,9)	1.114 (28,3)	0.062 (1,6)
8904-0171-XX	1.254 (31,9)	1.114 (28,3)	0.093 (2,4)
8905-0171-XX	1.254 (31,9)	1.114 (28,3)	0.125 (3,2)
8906-0171-XX	1.254 (31,9)	1.114 (28,3)	0.156 (4,0)
8907-0171-XX	1.254 (31,9)	1.114 (28,3)	0.187 (4,7)
8908-0171-XX	1.254 (31,9)	1.114 (28,3)	0.250 (6,4)
8905-0168-XX	1.375 (34,9)	0.875 (22,2)	0.032 (0,8)
8906-0168-XX	1.375 (34,9)	0.875 (22,2)	0.062 (1,6)
8907-0168-XX	1.375 (34,9)	0.875 (22,2)	0.093 (2,4)
8904-0168-XX	1.375 (34,9)	0.875 (22,2)	0.125 (3,2)
8908-0168-XX	1.375 (34,9)	0.875 (22,2)	0.156 (4,0)
8901-0168-XX	1.375 (34,9)	0.875 (22,2)	0.187 (4,7)
8909-0168-XX	1.375 (34,9)	0.875 (22,2)	0.250 (6,4)
8906-0170-XX	1.375 (34,9)	1.125 (28,6)	0.032 (0,8)
8907-0170-XX	1.375 (34,9)	1.125 (28,6)	0.062 (1,6)
8908-0170-XX	1.375 (34,9)	1.125 (28,6)	0.093 (2,4)
8901-0170-XX	1.375 (34,9)	1.125 (28,6)	0.125 (3,2)
8909-0170-XX	1.375 (34,9)	1.125 (28,6)	0.156 (4,0)
8904-0170-XX	1.375 (34,9)	1.125 (28,6)	0.187 (4,7)
8902-0170-XX	1.375 (34,9)	1.125 (28,6)	0.250 (6,4)
8906-0174-XX	1.540 (39,1)	1.340 (34,0)	0.032 (0,8)
8907-0174-XX	1.540 (39,1)	1.340 (34,0)	0.062 (1,6)
8908-0174-XX	1.540 (39,1)	1.340 (34,0)	0.093 (2,4)
8902-0174-XX	1.540 (39,1)	1.340 (34,0)	0.125 (3,2)
8909-0174-XX	1.540 (39,1)	1.340 (34,0)	0.156 (4,0)
8910-0174-XX	1.540 (39,1)	1.340 (34,0)	0.187 (4,7)
8905-0174-XX	1.540 (39,1)	1.340 (34,0)	0.250 (6,4)

All dimensions shown are in inches (millimeters) unless otherwise specified.

# KNITTED CONDUCTIVE GASKETS

## ELECTROGROUND<sup>®</sup> EMI WASHERS

TABLE 1. DIMENSIONS (continued)

Laird Technologies Part No.	O.D.	I.D.	Free Height Maximum "T"
8903-0175-XX	1.625 (41,3)	1.125 (28,6)	0.032 (0,8)
8904-0175-XX	1.625 (41,3)	1.125 (28,6)	0.062 (1,6)
8905-0175-XX	1.625 (41,3)	1.125 (28,6)	0.093 (2,4)
8906-0175-XX	1.625 (41,3)	1.125 (28,6)	0.125 (3,2)
8907-0175-XX	1.625 (41,3)	1.125 (28,6)	0.156 (4,0)
8918-0175-XX	1.625 (41,3)	1.125 (28,6)	0.187 (4,7)
8909-0175-XX	1.625 (41,3)	1.125 (28,6)	0.250 (6,4)
8902-0176-XX	1.884 (47,9)	1.760 (44,7)	0.032 (0,8)
8901-0176-XX	1.884 (47,9)	1.760 (44,7)	0.062 (1,6)
8903-0176-XX	1.884 (47,9)	1.760 (44,7)	0.093 (2,4)
8904-0176-XX	1.884 (47,9)	1.760 (44,7)	0.125 (3,2)
8905-0176-XX	1.884 (47,9)	1.760 (44,7)	0.156 (4,0)
8916-0176-XX	1.884 (47,9)	1.760 (44,7)	0.187 (4,7)
8907-0176-XX	1.884 (47,9)	1.760 (44,7)	0.250 (6,4)

TABLE 2. MATERIALS

Material Code	Type	Wire Specification
40	Beryllium Copper	25 Alloy QQC-530
42	Monel <sup>®</sup>	QQN-281 Class A
43	Aluminum	5056 Alloy
44	Tin Plated Steel	ASTM B520
46	Stainless Steel	304

Other alloys available upon request.

TABLE 3. TOLERANCES

T Sizes	O.D.	I.D.
0.030 (0,8) to 0.062 (1,6)	± 0.010 (±0,3)	± 0.010 (±0,3)
0.062 (1,6) to 1.0 (25,4)	± 0.015 (±0,4)	± 0.015 (±0,4)
1.0 (25,4) to 2.0 (50,8)	± 0.020 (±0,5)	± 0.020 (±0,5)

### How to Specify

- From Table 1 on pages 25 to 27, determine the O.D., the I.D., and the thickness "T" of the ElectroGround washer that suits the specific application. Note: Please consult Laird Technologies sales department for sizes not shown in Table 1.
- From Table 2, insert material code in place of XX in base part number.
- For tolerances O.D. and I.D. refer to Table 3.

### Example:

- Dimensions required: O.D. = 0.200 I.D. = 0.125, and Thickness = 0.032 (from Table 1).
- Base Part Number: 8904-0178-XX (from Table 1).
- Material required is Beryllium Copper Code 40 (from Table 2).
- Full part number is 8904-0178-40.

# KNITTED CONDUCTIVE GASKETS

## ELECTROMESH<sup>®</sup> TAPE

Laird ElectroMesh tape has a double layered strip of knitted wire mesh to provide effective EMI shielding and grounding for electrical and electronic cable assemblies.

It is particularly useful in applications where the need for EMI protection is determined after cable assembly is complete and standard braided cable jackets cannot be used. The flexible structure of the ElectroMesh Tape permits it to conform to irregular surfaces and contours during the wrapping process.

- Tin plating for excellent solderability
- Useful in both shielding and grounding applications for static discharge
- Tin plated copper clad steel wire provides greater strength and performance than other tape materials
- Knit loop structure provides uniform coverage without any wrinkles or creases
- Available in other alloys and wire dimensions
- Supplied in 50 ft. (15,2 m) rolls. (Note: When determining quantity needed, 50% overlap is recommended.)
- Mesh tape also available in Monel<sup>®</sup> (material code 42); BeCu (material code 40); Aluminum (material code 43); and Stainless Steel (material code 46)
- Other alloys available upon request

ElectroMesh tape is 0.020 (0,5) thick. It is available in tin plated copper clad steel ASTM-B-250, with a diameter of 0.005 (0,1) and with 10–12 openings per inch.



TABLE 1. ELECTROMESH TAPE PART NUMBERS

Laird Technologies Part No.	Width
8300-0025-44	0.250 ± 0.040 (6,4 ± 1,0)
8300-0038-44	0.380 ± 0.040 (9,7 ± 1,0)
8300-0050-44	0.500 ± 0.060 (12,7 ± 1,5)
8300-0075-44	0.750 ± 0.060 (19,1 ± 1,5)
8300-0100-44	1.000 ± 0.060 (25,4 ± 1,5)
8300-0150-44	1.500 ± 0.120 (38,1 ± 3,1)
8300-0175-44	1.750 ± 0.120 (44,5 ± 3,1)
8300-0225-44	2.250 ± 0.190 (57,2 ± 4,8)

# CONDUCTIVE FABRIC



Flectron<sup>®</sup> metallized fabric combines highly conductive metals with lightweight fabric to meet a diverse range of EMI/RFI shielding requirements.

Manufactured with Laird patented technology, Flectron metallized fabric is available in various woven and non-woven substrate configurations.

Whether used as an architectural shielding product to shield complete rooms, or as the shielding material in EMI gaskets, tapes, and shield laminates, Flectron fabrics provide a highly effective shielding system that is cost-effective and easily applied.

Laird uses a patented technology for applying thin metal coatings of copper and nickel to woven and nonwoven fabrics. As a result, Flectron metallized materials have the flexibility, conformability and breathability of a fabric with the electrical properties of a metal. This means low surface and through resistivity and excellent shielding effectiveness.

For specific material properties, see data summary chart

NA = Not Applicable

<sup>1</sup> Product Specifications

<sup>2</sup> Measured per Typical values

<sup>3</sup> Typical values for unplated fabric.

<sup>4</sup> CD = cross machine direction, MD = machine direction

<sup>†</sup> Nominal Value

\* Modified

## FLECTRON<sup>®</sup> PRODUCTS DATA SUMMARY

	Product No.	Nominal Thickness Inches (mm)	Surface Resistivity <sup>1</sup> (Ohms / square) (ASTM F390*)	Shielding <sup>2</sup> at 100 MHz/1GHz (dB)	Tensile Strength <sup>3</sup> CD/MD <sup>4</sup> (lb/in) (ASTM D5035*)	Weight (oz / yd <sup>2</sup> ) (LT 500)	Max. Short Duration Temperature (°C)	
	Ni/Cu Polyester Nonwoven	3027-217	0.016 (0.4)	< 0.07	105/90	7.5/18.5	2.8 – 4.5	210
	Ni/Cu Polyester Nonwoven UL94 VTM-0	3027-235	0.016 (0.4)	< 0.07	100/100	7.5/18.5	3.6 - 5.7	210
	Ni/Cu Polyester Taffeta	3035-535	0.0045 (0.114)	< 0.07	80/80	50/75	2.2 – 3.1	210
	Ni/Cu Polyester Taffeta UL94 V0	3035-216	0.008 (0.2)	< 0.07	80/70	50/75	6†	100
	Ni/Cu Polyester Mesh	3070-500	0.007 (0.178)	< 0.1	70/60	20/20	1.3 – 2.3	210
	Ni/Cu Nylon Ripstop	3050-525	0.005 (0.1)	< 0.07	85/75	25/50	2.1 – 2.7	200
	Ni/Cu Nylon Ripstop UL94 V0	3050-517	0.008 (0.2)	< 0.07	85/75	25/50	5.0 – 6.0	100
	Ni/Cu Nylon Nonwoven	3078-500	0.024 (0.6)	< 0.07	60/65	280/805	7 – 10	185

Product No.	Material	Description	Application
3027-217	Ni/Cu Polyester Nonwoven	The base layer is the highly conductive copper, with an outer layer of nickel for corrosion resistance. Combines the properties of these metals with the lightweight, flexibility and breathability of a nonwoven material. Offers excellent surface conductivity, shielding effectiveness, and corrosion resistance.	Protects against EMI/RFI and ESD for a variety of applications and environments: architectural shielding, gaskets, tapes, shielding materials and ribbon.
3027-235	Ni/Cu Polyester Nonwoven UL94 VTM-0	Combines highly conductive copper and corrosion resistant nickel with the lightweight, flexibility and breathability of a nonwoven material. Offers excellent surface conductivity, shielding effectiveness and corrosion resistance. This product achieves the UL94 VTM-0 flammability rating.	Protects against EMI/RFI and ESD for a variety of applications and environments: architectural shielding, gaskets, tapes, shielding laminates, and grounding.
3035-535	Ni/Cu Polyester Taffeta	Combines highly conductive copper and corrosion resistant nickel with the lightweight, flexibility, conformability, strength and uniform appearance of a woven. Nickel/Copper Polyester Taffeta offers excellent surface conductivity, shielding effectiveness, and reflectivity.	Protects against EMI/RFI for a variety of applications and environments: enclosures, curtains, gaskets, cable wrap, tapes, shielding laminates, and grounding.
3035-216	Ni/Cu Polyester Taffeta UL94 V0	Combines highly conductive copper and corrosion resistant nickel with the lightweight, flexibility, conformability, strength and uniform appearance of a woven material. Provides excellent surface conductivity, shielding effectiveness and a UL94 V0 rating.	Protects against EMI/RFI for a variety of applications and environments: enclosures, curtains, gaskets, cable wrap, tapes, shielding laminates, and grounding.
3070-500	Ni/Cu Polyester Mesh	Combines highly conductive copper and corrosion resistant nickel with the lightweight, flexibility, conformability, breathability and uniform appearance of a knitted mesh. Mesh offers excellent surface conductivity, shielding effectiveness, and reflectivity for a variety of applications.	Protects against EMI/RFI for a variety of applications and environments: enclosures, curtains, gaskets, cable wrap, tapes, shielding laminates, and grounding.
3050-525	Ni/Cu Nylon Ripstop	This technology combines highly conductive copper and corrosion resistant nickel with the lightweight, drapability, strength, flexibility, conformability, and attractive appearance of a Nylon Ripstop. Nickel/Copper Nylon Ripstop offers excellent surface conductivity, shielding effectiveness, and reflectivity.	Protects against EMI/RFI: enclosures, curtains, gaskets, tapes, shielded laminates, infrared camouflage, and radar reflector.
3050-517	Ni/Cu Nylon Ripstop UL94 V0	This technology combines highly conductive copper and corrosive resistant nickel with the drapability, strength, flexibility, and attractive appearance of a Nylon Ripstop fabric. Provides excellent surface conductivity, shielding effectiveness, and UL94 V0 rating.	Protects against EMI/RFI: enclosures, cables, tapes, and grounding.
3078-500	Ni/Cu Nylon Nonwoven UL94 V0	Combines highly conductive copper and corrosion resistant nickel with the light weight, flexibility and breathability of a nonwoven material. Offers excellent surface conductivity, shielding effectiveness and corrosion resistance. This product achieves the UL94 V0 flammability rating.	Protects against EMI/RFI and ESD for a variety of applications and environments: architectural shielding, gaskets, tapes, shielding laminates, and grounding.

# MRI "A" FABRIC



## MRI "A" FABRIC

Laird MRI "A" Fabric is an EMI/RFI shielding product that is manufactured using a patented, proprietary technology. The base layer is a metallized non-woven fabric plated with highly conductive copper and nickel for corrosion resistance. This is bonded to a thin layer of solid aluminum. The resulting material is a lightweight architectural material with superior shielding effectiveness and outstanding resilience. Specifically, this product provides superior shielding effectiveness well in excess of industry standards throughout the MRI frequency range. The product can be applied using several standard construction techniques depending upon the installation requirements or specifications. Because of the relative ease of installation with this product, construction time and therefore, the time to get the MRI facility on-line is greatly reduced.

- Flexible and lightweight
- Corrosion resistant and highly conductive
- Provides excellent shielding
- Excellent electrical properties
- Fewer seams required
- NFPA Class A Flame rating

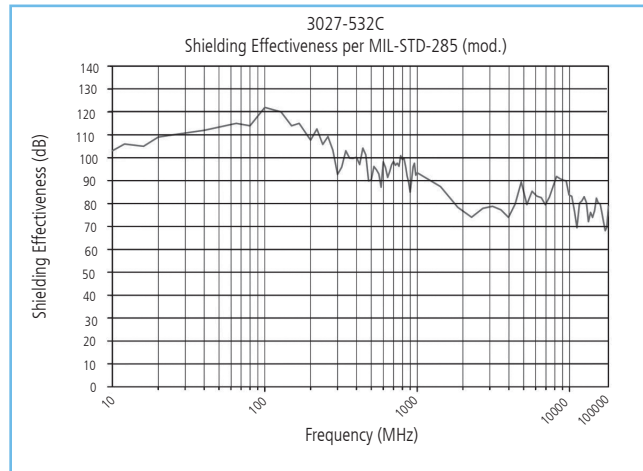

## PHYSICAL PROPERTIES

Substrate	Metal	Thickness (ASTM D1777)	Total Weight oz./yd <sup>2</sup>	Max. Short Duration Temp. (g/m <sup>2</sup> )	Standard Roll Width inches (cm)
Composite Polyester Non-woven Fabric and Foil	Fabric: Nickel/Copper Foil: Aluminum	0.016 +/- 0.002 (406 +/- 51)	7.5 +/- 1.3 (254 +/- 44)	194°F (90°C)	51 (130)

## ELECTRICAL PROPERTIES

Surface Resistivity ASTM F390 ohms/square	Shielding Effectiveness dB (typical)				
	25.4 MHz	64 MHz	100 MHz	168 MHz	400 MHz
< 0.07	>108*	>115*	>122*	>115*	>107*

\* Values exceed the dynamic range of the test equipment and were measured in actual MRI shielded enclosures.

## MECHANICAL PROPERTIES

Tensile Strength CMD/MD (ASTM D5035) lb./in (N/100 mm)	Elongation, MD (ASTM D5035)
20/60 (350/1050)	8%

All dimensions shown are in inches (millimeters) unless otherwise specified.



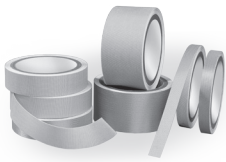

# CONDUCTIVE TAPE

## CONDUCTIVE FABRIC SHIELDING TAPE

Laird conductive fabric shielding tapes offer exceptional conformability and conductivity for dynamic flex applications. Conductive tapes are constructed of nickel/copper metallized fabric with a conductive pressure sensitive adhesive (PSA). This reliable tape design provides outstanding shielding performance while offering superior abrasion and corrosion resistance under high dynamic flex conditions.

Significant advantages over other fabric and foil shielding tapes include:

- Available UL510 flame rating.
- Thinner design provides superior flexibility and durability.
- High conductivity and shielding effectiveness.
- Adhesive system provides high peel strength.
- Easy die-cutting and processing.
- Superb adhesion of nickel copper plating.
- Eliminates the potential of injury due to the sharp edges of metal foil tapes.

EMI shielding tape is available in standard roll widths from 0.394" (10 mm) to 3.937" (100 mm) in 0.197" (5 mm) increments and roll lengths of 65.62' (20 M). Master rolls are available in sizes up to 1.0 meter widths and 20 meter lengths. For your unique design requirements, custom die-cut parts are also available.

Some typical applications for EMI shielding tapes include:

- Shielding cables on notebook computers, copiers or other electronic equipment.
- "Fix-it" applications in test laboratories.
- Shielding over a component in which high conformability is essential.
- Shielding or grounding in weight sensitive applications.
- Shielding or grounding for electronic equipment where vibration may be present during operation.

TAPE CONSTRUCTION *	
Carrier	Nickel Copper Ripstop / Tafeta Fabric (1A)
Adhesive	Conductive Pressure Sensitive Acrylic Adhesive
Liner	Kraft Paper

PERFORMANCE CHARACTERISTICS *	
Conductive Tape Thickness	0.005 ± 0.0008 inches (0.13 ± 0.02 mm)
Tensile Strength (ASTM D5035)	50 lb / in.
Weight (LT 500)	2.9 oz./sq. yard (100 grams/sq. Meter)
XY Sheet Resistivity (ASTM F390)	< 0.03 ohms/sq.
Peel Strength	28 oz./in. (8.7 N/25 mm)
Abrasion Resistance (ASTM D3886)	> 750,000 Cycles
Temperature Range	32°F to 176°F (0°C to 80°C)
Max. Temperature (short term)	120°C
Shielding Effectiveness	100 MHz @ 70 dB 1 GHz @ 80 dB 3 GHz @ 90 dB
Z-Axis Resistivity	< 0.040 ohms
Shelf Life	6 months @ 23°C, 60% R.H.

## ORDERING INFORMATION:

86-726	Standard Tape
86-785	Standard Tape
86-203	Black Tape
86-205	Black Tape
87-580	UL510 Rated
DS005	Double Sided Tape
D6-785FX	Double Sided Tape
76-750	Thin Tape

\* Properties for standard tapes. Other tape properties available upon request.

# INTRODUCTION TO ELECTRICALLY CONDUCTIVE ELASTOMERS

## OVERVIEW

The electrically conductive elastomers are based on dispersed particles in elastomers, oriented wire in solid or sponge elastomers, impregnated wire mesh screens or expanded metals. They provide highly conductive, yet resilient gasketing materials for EMI sealing as well as pressure and environmental sealing.

Conductive elastomers are used for shielding electronic enclosures against electromagnetic interference (EMI). Usually, the shielding system consists of a conductive gasket sandwiched between a metal housing and lid. The primary function of these gaskets is to provide sufficient electrical conductivity across the enclosure/gasket/lid junction to meet grounding and EMI shielding requirements, as well as prevent intrusion of the fluids into the electrical components.

Laird offers conductive elastomers in the following forms:

1. ElectroSeal dispersed filler particles in elastomers
2. ElectroMet oriented wire in solid and sponge elastomers, and impregnated wire mesh and expanded metals

## ELECTROSEAL™ GASKET INTRODUCTION

Conductive elastomer gaskets are EMI shielding and sealing devices made from highly conductive, mechanically resilient and conformable vulcanized elastomers. They are available in the following types:

1. Flat gaskets or die-cuts
2. Molded shapes such as O-rings or intricate parts
3. Extruded profiles or strips
4. Vulcanized-to-metal covers or flanges
5. Co-molded or reinforced seals
6. Form-in-place gaskets

When any two flat, but rigid surfaces are brought together, slight surface irregularities on each surface prevent them from meeting completely at all points. These irregularities may be extremely minute, yet may provide a leakage path for gas or liquid under pressure, and for high frequency electromagnetic energy. This problem remains in flange sealing even when very high closure force is applied.

However, when a gasket fabricated of resilient material is installed between the mating surfaces, and even minimal closure pressure is applied, the resilient gasket conforms to the irregularities in both mating surfaces. As a result, all surface imperfections and potential leak paths across the joint area are sealed completely against pneumatic and fluid pressure or penetration by environmental gases. If the gasket is conductive as well as resilient, with conductive matrix distributed throughout its total volume in mesh or particle form, the joint can be additionally sealed against penetration by, or exit of, electromagnetic energy.

# ELECTROSEAL CONDUCTIVE ELASTOMER

## PRODUCT SELECTION GUIDE

### ECE POLYMER MATERIAL MATRIX

	<b>Benefit</b>	<b>Ag (Silver)</b>	<b>AgCu</b>	<b>AgNi</b>	<b>AgAl</b>	<b>AgGlass</b>	<b>Ni</b>	<b>NiAl</b>	<b>NiGraphite</b>	<b>Carbon</b>	<b>Non-Conductive</b>
Silicone	good all purpose material	ECE082/083	ECE080/094	ECE084	ECE081	ECE085	ECE100	ECE032	ECE072/093	ECE087	NCE220
Fluorosilicone	fuel and oil resistant	-NA-	ECE088	ECE090	ECE050/089	ECE011	-NA-	-NA-	ECE092	-NA-	-NA-
EPDM	biohazard resistant	-NA-	-NA-	-NA-	ECE096	-NA-	-NA-	-NA-	ECE095	ECE013	-NA-

### FIP RESIN MATRIX



	<b>Benefit</b>	<b>AgCu</b>	<b>AgNi</b>	<b>AgAl</b>	<b>NiGraphite</b>	<b>Non-Conductive</b>
RXP - room temperature cure	simple dispense process	SNK55	SNN60	SNL60	SNC70	SIL25
HXP - heat cure	longer shelf life	SNK60	SNN65	SNL70	SNC70	SIL35

# ELECTROSEAL CONDUCTIVE ELASTOMER

## CASE STUDY

### EXAMPLE

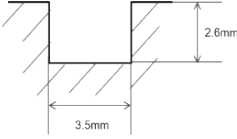
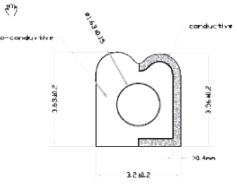
A Telecommunication customer A is looking for a gasket for RRU chassis. The chassis will be made of Aluminum by casting. There is an existing design including groove. Groove dimension is as follows. The customer is looking for an electromagnetic shielding larger than 50 dB for the chassis. And high reliability is required considering RRU unit will be exposed in open air and sustain various weather condition such as snow, rain, fog, etc.

	Selection Process	Conclusion
<b>Select elastomer base</b>	Take reference of Table 1	Silicone
	All the three bases can meet resistance requirement against weather, but silicone is the most cost effective one. And also best on availability and processibility.	
<b>Select filler system</b>	"Take reference of Table 3 for galvanic performance and Material Selection Table 6 1. Ag/Al filler would be most compatible with casting aluminum. 2. Ni/Graphite is a cost effective solution but still acceptable. Can be a candidate for future cost/performance comparison. 3. Better use a hybrid design considering high reliability requirement. 4. Both filler system can provide high shielding. But final performance would rely also on final design."	"Hybrid (NCE+ECE), ECE81(Ag/Al) or ECE93(Ni/Graphite) "
<b>Design Shape &amp; Dimension</b>		
Closure force	Medium closure force required because the RRU unit need to sustain water flush without high pressure	Hollow cross section
Is there an existing design? (part/groove/flange/interface)	There is an existing groove design. But can not find corresponding groove recommendation in brochure. Would need a design on gasket. Contact Laird FAE for it.	
What's the shape?	Existing groove design is rectangle shaped. A standard double D co-extrusion might work	Double D co-extrusion or custom design
Decide dimension	"Filling percentage >90% to bear water flush Compression >=25% considering large coplanarity of chassis and cover Final FEA possible to confirm the design Co-extrusion required because the total length is 1600 mm"	
How to mount the gasket?	Would need a PSA to hold the strip in groove	
	But a friction fit design can also be done for easy assembly and cost saving. Example	

# ELECTROSEAL CONDUCTIVE ELASTOMER

## CASE STUDY

TABLE 1

Elastomer Type	Low Temperature	Upper Temperature
EPDM	-58°F (-50°C)	257°F (125°C)
Silicone	-49°F (-45°C)	392°F (200°C)
Fluorosilicone	-67°F (-55°C)	347°F (175°C)

TABLE 2

Fluid	Silicone	Fluorosilicone	EPDM
Impermeability to Gases	Poor	Fair	Good
Ozone and Ultraviolet	Excellent	Excellent	Excellent
ASTM 1 Oil	Fair	Good	Don't Use
Hydraulic Fluids (Organic)	Fair	Good	Don't Use
Hydraulic Fluids (Phosphate ester)	Fair	Fair	Excellent
Hydrocarbon Fuels	Don't Use	Good	Don't Use
Dilute Acids	Fair	Good	Good
Concentrated Acids	Don't Use	Don't Use	Fair / Good
Dilute Bases	Fair	Good	Excellent
Concentrated Bases	Don't Use	Don't Use	Good
Esters / Ketones	Don't Use	Don't Use	Excellent
D5-2 (Decontaminating Fluid)	Poor	Poor	Good
STB (Decontaminating Fluid)	Good	Good	Good
Low Temperature	Excellent	Excellent	Excellent
High Temperature	Excellent	Good	Good
Compression Set	Good	Good	Good
Radiation Resistance	Good	Poor	Good

TABLE 3

Metal Substrate	80 Sil AG/CU	81 Sil AG/AL	84 Sil AG/NI	85 Sil AG/Glass	89 FSil AG/AL	92 FSil NI/Graphite	93 Sil NI/Graphite	96 EPDM AG/AL
Chromated Al	•	•	•	•	•	•	•	•
Galvalume®	•	•	•	•	•	•	•	•
Tin Plated Steel	•	•	•	•	•	•	•	•
Zinc Plated Steel	•	•	•	•	•	•	•	•
Stainless Steel	•	•	•	•	•	•	•	•

TABLE 4

Material Thickness	Compression Force PSI (MPa) at Deflection of:			
	5%	* 10%	15%	20%
0.045 (1,1)	40 (0,3)	100 (0,7)	155 (1,1)	280 (1,9)
0.062 (1,6)	85 (0,6)	165 (1,1)	240 (1,7)	345 (2,4)
0.125 (3,2)	115 (0,8)	180 (1,2)	245 (1,7)	290 (2,0)

TABLE 5

Cross Section Shape	Deflection
Flat Strip	5-10 Percent
Solid O	20-25 Percent
Solid D	15-20 Percent
Hollow O	20-50 Percent
Hollow D	25-50 Percent
Hollow P	25-50 Percent
Interference Fit	15-25 Percent

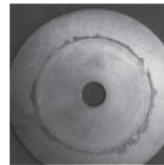

Little to no weight loss on metal coupon; less than 0.25%. Acceptable in all environments.

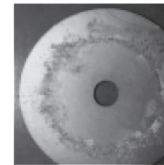

Substantial amount of weight loss on metal coupon; between 0.50% and 1.25%. Not acceptable in corrosive environments; for less corrosive applications consult with Laird applications engineer.

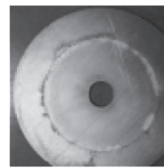

Moderate amount of weight loss on metal coupon; between 0.25% and 0.50%. May not be acceptable in very corrosive environments.

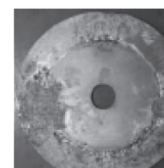

Extreme amount of weight loss on metal coupon; greater than 1.25%. Not recommended in any environments.

# ELECTROSEAL CONDUCTIVE ELASTOMER

## CASE STUDY

### MATERIAL SELECTION GUIDE

Laird offers a series of products to meet a wide range of customer requirements for military and commercial applications. The classifications of the most common materials are based on cost and specific applications and are outlined in Table 5.

**TABLE 6**

PARAMETER	TEST METHOD	Ni/graphite	silver/ copper	silver/Al	silver	silver	silver/ nickel	silver/glass	carbon
Filler		Ni/graphite	silver/ copper	silver/Al	silver	silver	silver/ nickel	silver/glass	carbon
Elastomer		silicone	silicone	silicone	silicone	silicone	silicone	silicone	silicone
EcE Name		EcE72	EcE80	EcE81	EcE82	EcE83	EcE84	EcE85	EcE87
<b>Electrical Properties</b>									
Volume Resistivity, $\Omega$ cm, max	MIL-DTL-83528C para 4.5.10	0.100	0.004	0.008	0.002	0.010	0.005	0.006	5.0
Shielding Eff, 10 GHz, dB, min	MIL-DTL-83528C para 4.5.12	100	120	100	120	80	100	100	30
<b>Physical Properties</b>									
Density, g/cm <sup>3</sup> ( $\pm 0.25$ )	ASTM D792	2.30	3.40	2.00	3.50	1.80	4.00	1.90	1.30
Hardness, Shore A ( $\pm 7$ )	ASTM D2240	75	65	65	65	45	75	65	75
Tensile Strength, psi, min	ASTM D412	280	200	200	300	150	200	200	700
Elongation	ASTM D412	150%	100-300%	100-300%	100-300%	50-250%	100-300%	100-300%	100-300%
Tear Strength, ppi, min	ASTM D624, die C	55	25	30	50	20	30	30	50
Compression Set, max	ASTM D395	30%	32%	32%	45%	35%	32%	30%	45%
Max Oper. Temp., °C	MIL-DTL-83528C para 4.5.15	160	125	160	160	160	125	160	160
Min. Oper. Temp., °C	ASTM D1329	-55	-55	-55	-55	-55	-55	-55	-55
Flame Retardance	UL 94	V-0			UL 94 HB (File No. E203 070)				
<b>Electrical Stability</b>									
After Heat Aging, $\Omega$ cm, max	MIL-DTL-83528C para 4.5.15	-	0.010	0.010	0.010	0.015	0.010	0.015	7.0
After Break, $\Omega$ cm, max	MIL-DTL-83528C para 4.5.9	-	0.008	0.015	0.010	0.020	0.010	0.009	7.0
During Vibration, $\Omega$ cm, max	MIL-DTL-83528C para 4.5.13	-	0.006	0.012	0.010	0.015	0.010	0.009	N/A
After Exposure to EMP, $\Omega$ cm, max	MIL-DTL-83528C para 4.5.16	-	0.010	0.010	0.010	0.015	0.010	0.015	N/A
Compression / Deflection, %, min	ASTM D575	8	3.5	3.5	2.5	8.0	3.5	3.5	3.5
Fluid Immersion <sup>1</sup>	MIL-DTL-83528C para 4.5.17	-	NS	NS	NS	NS	NS	NS	NS
<b>Manufacturing Processes</b>									
molded sheet / diecut parts		X	X	X	X	X	X	X	X
molded shapes / O-rings		X	X	X	X	X	X	X	X
extruded profiles		X	X	X	X	X	X	X	
Color		gray	tan	tan	beige	beige	tan	tan	black
Mil-DTL-83528 Type		-	A	B	E	J	L	M	-

1 SUR indicates meets the immersion test requirements for 10 specified military/aerospace fluids  
2 UL94 V-1

3 used only for low density low hardness  
4 UL94 HB  
5 corrosion resistant silver/Al filler

# ELECTROSEAL CONDUCTIVE ELASTOMER

## CASE STUDY

TABLE 6 (cont.)

PARAMETER													
Filler	Ni/ graphite	silver/ copper	nickel	N/A	carbon	Ni/ graphite	silver/Al	silver/ glass	silver/Al	silver/ copper	silver/Al	silver/ nickel	Ni/ graphite
Elastomer	silicone	silicone	silicone	silicone	EPDM	EPDM	EPDM	fluorosilicone	fluorosilicone	fluorosilicone	fluorosilicone	fluorosilicone	fluorosilicone
EcE Name	EcE93	EcE94	EcE100	NCE220	EcE13	EcE95	EcE96	EcE11	EcE50	EcE88	EcE89	EcE90	EcE92
<b>Electrical Properties</b>													
Volume Resistivity, $\Omega$ cm, max	0.100	0.005	0.200	Non	30	0.100	0.010	0.010	0.012	0.010	0.012	0.005	0.100
Shielding Eff, 10 GHz, dB, min	100	120	–	Conductive	30	70	90	90	95	110	100	100	100
<b>Physical Properties</b>													
Density, g/cm <sup>3</sup> ( $\pm 0.25$ )	1.90	3.60	4.00	1.20	1.20	2.20	2.20	2.00	2.10	4.10	2.20	4.10	2.20
Hardness, Shore A ( $\pm 7$ )	55	85	75	70	80	80	80	75	75	75	70	75	75
Tensile Strength, psi, min	150	400	450	405	2000	200	200	200	200	180	180	300	150
Elongation	100-300%	100-300%	–	100-400%	100-400%	70-260%	70-260%	60-200%	60-260%	100-300%	60-260%	100-300%	60-250%
Tear Strength, ppi, min	30	40	50	–	100	60	60	30	35	30	30	50	40
Compression Set, max	30%	35%	–	–	30%	40%	50%	30%	30%	35%	30%	25%	30%
Max Oper. Temp., °C	160	125	160	150	125	125	160	160	160	125	160	160	160
Min. Oper. Temp., °C	-55	-45	-55	-50	-40	-40	-40	-50	-55	-55	-55	-50	-55
Flame Retardance	UL 94 HB (File No. E203 070)			UL 94 HB (File No. E203 070)			UL 94 HB (File No. E203 070)						
<b>Electrical Stability</b>													
After Heat Aging, $\Omega$ cm, max	0.200	0.010	0.400	n/a	40	–	–	0.015	0.015	0.015	0.015	0.010	0.200
After Break, $\Omega$ cm, max	0.200	0.010	–	n/a	–	–	–	0.015	0.015	0.015	0.015	0.010	0.200
During Vibration, $\Omega$ cm, max	0.200	0.010	–	n/a	–	–	–	0.015	0.015	0.015	0.015	0.010	0.200
After Exposure to EMP, $\Omega$ cm, max	0.100	0.015	–	n/a	–	–	–	–	0.015	0.015	0.015	0.010	0.100
Compression / Deflection, %, min	8.0	2.5	–	–	3.0	3.0	3.0	3.0	3.0	3.5	3.5	3.0	5.0
Fluid Immersion <sup>1</sup>	NS	NS	NS	–	NS	NS	NS	SUR	SUR	SUR	SUR	SUR	SUR
<b>Manufacturing Processes</b>													
molded sheet / diecut parts	X	X	X	X	X	X	X	X	X	X	X	X	X
molded shapes / O-rings	X	X	X	X	X	X	X	X	X	X	X	X	X
extruded profiles	X	X	X	X		X	X	X	X	X	X	X	X
Color	black	tan	dk gray	blue	black	black	tan	tan	tan	tan	blue	tan	dk gray
Mil-DTL-83528 Type	–	K	–	–	–	–	–	–	–	C	D	–	–

# VISUAL PART REFERENCE GUIDE

## ELECTROSEAL CONDUCTIVE ELASTOMERS

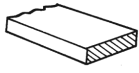

**Rectangular Strips**  
Page 87

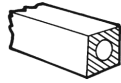

**Hollow Rectangular Strips**  
Page 87

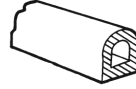

**Hollow D-Strips**  
Page 88

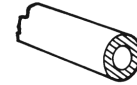

**O-Strip Tubing**  
Page 89

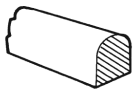

**D-Strips**  
Page 90

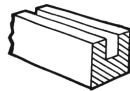

**Channel Strips**  
Page 90

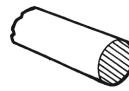

**O-Strips**  
Page 91

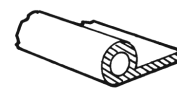

**P-Strip Tubing**  
Page 92

## CO-EXTRUSION

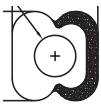

Page 93

## ELECTROSEAL CONDUCTIVE ELASTOMER FABRICATED COMPONENTS

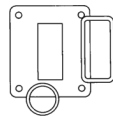

Page 95

## MIL CONNECTOR GASKETS



Page 101

## "D" SUBMINIATURE CONNECTOR SHIELDS

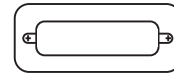

Page 101

## FORM-IN-PLACE EMI DISPENSED GASKETS

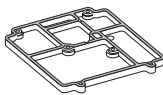

Page 103

## METAL IMPREGNATED MATERIALS

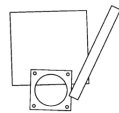

Page 99

## ELECTROCOAT

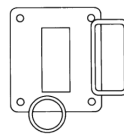

Page 102



# ELECTROSEAL CONDUCTIVE ELASTOMER MATERIAL



## ELECTROSEAL™ CONDUCTIVE ELASTOMER EMI SHIELDING

Laird electrically conductive elastomer products are ideal for both military and commercial applications requiring both environmental sealing and EMI shielding. Compounds can be supplied in molded or extruded shapes, sheet stock, custom extruded, or die-cut shapes to meet a wide variety of applications.

Our conductive extrusions offer a wide choice of profiles to fit a large range of applications. The cross-sections shown on the following pages are offered as standard. Custom dies can be built to accommodate your specific design.

- Available in a wide variety of conductive filler materials
- Shielding effectiveness up to 120 dB at 10 GHz

## SHEET MATERIAL

The Table below lists thicknesses and sizes for our molded sheet material, while Table 3, page 82, shows the compounds available for all of our conductive silicone elastomers.

## HOW TO SPECIFY ECE

Decide on molded sheet stock or extruded shapes. Select the desired configuration and dimensions from Table 1 (for sheet stock) or page 85 (for extruded shapes). Select the desired material from Table 3. Insert material number from Table 3, page 82, in place of the letters XX in the Laird part number.

## Example

1. From page 87, for a rectangular strip measuring 0.500 in. (12,7 mm) x 0.075 in. (1,9 mm), part number is 8861-0130-XX.
2. From Table 3, on page 82, for silver-nickel filler, material number is 84.
3. Ordering part number is 8861-0130-84.\*

Note: Rectangular and D-shaped extrusions can be supplied with pressure sensitive adhesive tape.

\*If pressure sensitive adhesive is required, replace the fifth digit with a 9 (i.e. 8861-9130-84).

THICKNESS/TOLERANCE	10 X 10 SHEET	10 X 15 SHEET	15 X 20 SHEET	18 X 18 SHEET
0.020 ± 0.004 (0,5 ± 0,1)	8860-0020-100-XX	8860-0020-150-XX	8860-0020-300-XX	N/A
0.032 ± 0.005 (0,8 ± 0,1)	8860-0032-100-XX	8860-0032-150-XX	8860-0032-300-XX	8860-0032-324-XX
0.045 ± 0.005 (1,1 ± 0,1)	8860-0045-100-XX	8860-0045-150-XX	8860-0045-300-XX	8860-0045-324-XX
0.062 ± 0.007 (1,5 ± 0,2)	8860-0062-100-XX	8860-0062-150-XX	8860-0062-300-XX	8860-0062-324-XX
0.093 ± 0.010 (2,3 ± 0,3)	8860-0093-100-XX	8860-0093-150-XX	8860-0093-300-XX	8860-0093-324-XX
0.100 ± 0.010 (2,5 ± 0,3)	8860-0100-100-XX	8860-0100-150-XX	8860-0100-300-XX	8860-0100-324-XX
0.125 ± 0.010 (3,2 ± 0,3)	8860-0125-100-XX	8860-0125-150-XX	8860-0125-300-XX	8860-0125-324-XX

# EXTRUSIONS GUIDE

## Rectangular Strips

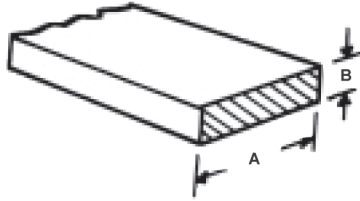

## Hollow Rectangular Strips

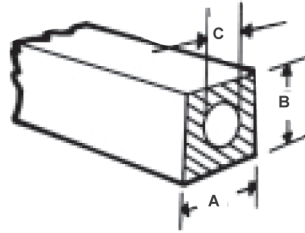

### TOLERANCES ALL PROFILES

DIMENSIONS	TOLERANCE
Under 0.101 (2,6)	± 0.005 (0,15)
0.101 to 0.200 (2,6 to 5,1)	± 0.008 (0,2)
0.201 to 0.300 (5,1 to 7,6)	± 0.010 (0,3)
0.301 to 0.500 (7,6 to 12,7)	± 0.015 (0,4)
Over 0.500 (12,7)	± 0.020 (0,5)

PART NUMBER	NOMINAL DIMENSIONS		
	A	B	C
8862-0112	0.125 (3,2)	0.125 (3,2)	0.078 (2,0)
8862-0113	0.200 (5,1)	0.130 (3,3)	0.090 (2,3)
8862-0114	0.250 (6,4)	0.250 (6,4)	0.156 (4,0)
8862-0100	0.330 (8,4)	0.305 (7,7)	0.125 (3,2)
8862-0105	0.375 (9,5)	0.375 (9,5)	0.188 (4,8)

MIL-DTL-85328 PART NUMBER	PART NUMBER	NOMINAL DIMENSIONS	
		A	B
M83528/009X001	8861-0100	0.063 (1,6)	0.042 (1,1)
	8861-0179	0.079 (2,0)	0.039 (1,0)
	8861-0181	0.079 (2,0)	0.059 (1,5)
M83528/009X002	8861-0105	0.095 (2,4)	0.062 (1,6)
	8861-0110	0.120 (3,0)	0.075 (1,9)
	8861-0115	0.125 (3,2)	0.062 (1,6)
M83528/009X004	8861-0120	0.156 (4,0)	0.062 (1,6)
	8861-0121	0.187 (4,8)	0.125 (3,2)
	8861-0167	0.188 (4,8)	0.062 (1,6)
M83528/009X005	8861-0193	0.189 (4,8)	0.189 (4,8)
	8861-0125	0.250 (6,4)	0.062 (1,6)
	8861-0173	0.250 (6,4)	0.125 (3,2)
M83528/002X006	8861-0174	0.250 (6,4)	0.188 (4,8)
	8861-0136	0.250 (6,4)	0.200 (5,1)
	8861-0175	0.252 (6,4)	0.031 (0,8)
M83528/009X007	8861-0183	0.378 (9,6)	0.063 (1,6)
	8861-0172	0.500 (12,7)	0.020 (0,5)
	8861-0131	0.500 (12,7)	0.042 (1,1)
M83528/009X008	8861-0182	0.500 (12,7)	0.059 (1,5)
	8861-0130	0.500 (12,7)	0.075 (1,9)
	8861-0188	0.500 (12,7)	0.094 (2,4)
M83528/009X009	8861-0135	0.500 (12,7)	0.125 (3,2)
	8861-0140	0.500 (12,7)	0.188 (4,8)
	8861-0142	0.750 (19,1)	0.040 (1,0)
M83528/009X010	8861-0141	0.750 (19,1)	0.042 (1,1)
	8861-0145	0.750 (19,1)	0.062 (1,6)
	8861-0184	0.827 (21,0)	0.071 (1,8)
M83528/009X011	8861-0189	0.827 (21,0)	0.094 (2,4)
	8861-0150	0.880 (22,4)	0.062 (1,6)
	8861-0103	0.984 (25,0)	0.043 (1,1)
M83528/009X012	8861-0169	1.00 (25,4)	0.062 (1,6)
	8861-0192	1.00 (25,4)	0.126 (3,2)
	8861-0155	1.00 (25,4)	0.250 (6,4)
M83528/009X013	8861-0160	1.18 (30,0)	0.062 (1,6)

# EXTRUSIONS GUIDE

## Hollow D-Strips

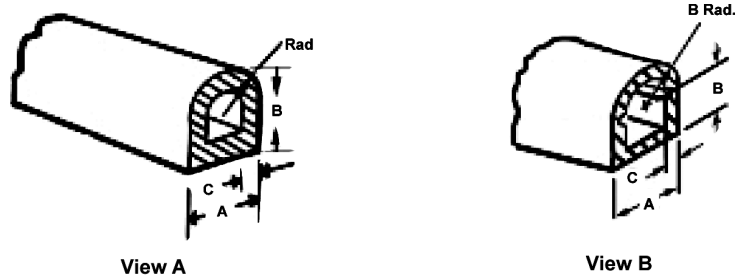

### TOLERANCES ALL PROFILES

DIMENSIONS	TOLERANCE
Under 0.101 (2,6)	± 0.005 (0,15)
0.101 to 0.200 (2,6 to 5,1)	± 0.008 (0,2)
0.201 to 0.300 (5,1 to 7,6)	± 0.010 (0,3)
0.301 to 0.500 (7,6 to 12,7)	± 0.015 (0,4)
Over 0.500 (12,7)	± 0.020 (0,5)

MIL-DTL-83528 PART NUMBER	PART NUMBER	DIMENSIONS				
		A	B	RAD	C	VIEW
	8866-0135	0.093 (2,4)	0.093 (2,4)	0.046 (1,2)	0.027 (0,7)	A
	8866-0160	0.098 (2,5)	0.098 (2,5)	0.049 (1,2)	0.020 (0,5)	A
	8866-0130	0.100 (2,5)	0.094 (2,4)	0.050 (1,3)	0.025 (0,6)	A
	8866-0162	0.109 (2,8)	0.125 (3,2)	0.054 (1,4)	0.024 (0,6)	A
M83528/007X001	8866-0100	0.156 (4,0)	0.156 (4,0)	0.078 (2,0)	0.045 (1,1)	A
	8866-0111	0.156 (4,0)	0.156 (4,0)	0.078 (2,0)	0.027 (0,7)	A
	8866-0103	0.158 (4,0)	0.240 (6,1)	0.079 (2,0)	0.040 (1,0)	A
	8866-0136	0.160 (4,1)	0.120 (3,0)	0.080 (2,0)	0.025 (0,6)	A
M83528/007X002	8866-0105	0.187 (4,8)	0.187 (4,8)	0.093 (2,4)	0.050 (1,3)	A
	8866-0131	0.250 (6,4)	0.145 (3,7)	0.125 (3,2)	0.030 (0,8)	A
	8866-0050	0.250 (6,4)	0.250 (6,4)	0.125 (3,2)	0.050 (1,3)	B
M83528/007X007	8866-0110	0.250 (6,4)	0.250 (6,4)	0.125 (3,2)	0.065 (1,7)	A
M83528/007X005	8866-0120	0.312 (7,9)	0.312 (7,9)	0.112 (2,8)	0.062 (1,6)	A
M83528/007X004	8866-0116	0.312 (7,9)	0.312 (7,9)	0.156 (4,0)	0.062 (1,6)	B
	8866-0127	0.325 (8,3)	0.575 (14,6)	0.287 (7,3)	0.080 (2,0)	A
	8866-0168	0.358 (9,1)	0.374 (9,5)	0.179 (4,5)	0.039 (1,0)	A
	8866-0166	0.374 (9,5)	0.252 (6,4)	0.187 (4,8)	0.039 (1,0)	A
	8866-0134	0.375 (9,5)	0.250 (6,4)	0.090 (2,3)	0.050 (1,3)	B
	8866-0137	0.375 (9,5)	0.250 (6,4)	0.187 (4,8)	0.032 (0,8)	A
	8866-0169	0.421 (10,7)	0.427 (10,8)	0.210 (5,3)	0.039 (1,0)	A
	8866-0126	0.480 (12,2)	0.335 (8,5)	0.240 (6,1)	0.035 (0,9)	A
M83528/007X006	8866-0125	0.487 (12,4)	0.324 (8,2)	0.244 (6,2)	0.062 (1,6)	A
	8866-0148	0.488 (12,4)	0.312 (7,9)	0.244 (6,2)	0.055 (1,4)	A
	8866-0139	0.488 (12,4)	0.324 (8,2)	0.244 (6,2)	0.063 (1,6)	A
	8866-0129	0.500 (12,7)	0.312 (7,9)	0.250 (6,4)	0.050 (1,3)	A
	8866-0155	0.625 (15,9)	0.400 (10,2)	0.312 (7,9)	0.057 (1,4)	A

# EXTRUSIONS GUIDE

## O-Strip Tubing

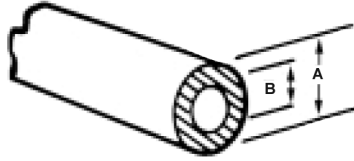

### TOLERANCES ALL PROFILES

DIMENSIONS	TOLERANCE
Under 0.101 (2,6)	± 0.005 (0,15)
0.101 to 0.200 (2,6 to 5,1)	± 0.008 (0,2)
0.201 to 0.300 (5,1 to 7,6)	± 0.010 (0,3)
0.301 to 0.500 (7,6 to 12,7)	± 0.015 (0,4)
Over 0.500 (12,7)	± 0.020 (0,5)

MIL-DTL-85328 PART NUMBER	PART NUMBER	NOMINAL DIMENSIONS	
		A	B
	8864-0136	0.085 (2,2)	0.035 (0,9)
	8864-0060	0.085 (2,2)	0.040 (1,0)
	8864-0173	0.085 (2,2)	0.050 (1,3)
	8864-0156	0.090 (2,3)	0.040 (1,0)
	8864-0161	0.090 (2,3)	0.045 (1,1)
	8864-0090	0.090 (2,3)	0.050 (1,3)
M83528/011X007	8864-0095	0.103 (2,6)	0.040 (1,0)
	8864-0142	0.103 (2,6)	0.050 (1,3)
	8864-0172	0.110 (2,8)	0.062 (1,6)
	8864-0153	0.115 (2,9)	0.062 (1,6)
M83528/011X001	8864-0100	0.125 (3,2)	0.045 (1,1)
M83528/011X006	8864-0101	0.125 (3,2)	0.062 (1,6)
	8864-0102	0.130 (3,3)	0.062 (1,6)
	8864-0104	0.145 (3,7)	0.070 (1,8)
	8864-0171	0.149 (3,8)	0.125 (3,2)
M83528/011X002	8864-0105	0.156 (4,0)	0.050 (1,3)
	8864-0163	0.156 (4,0)	0.062 (1,6)
	8864-0139	0.168 (4,3)	0.069 (1,8)
	8864-0162	0.177 (4,5)	0.092 (2,3)

MIL-DTL-85328 PART NUMBER	PART NUMBER	NOMINAL DIMENSIONS	
		A	B
M83528/011X008	8864-0143	0.177 (4,5)	0.079 (2,0)
	8864-0168	0.188 (4,8)	0.120 (3,0)
	8864-0147	0.216 (5,5)	0.125 (3,2)
	8864-0167	0.228 (5,8)	0.169 (4,3)
M83528/011X003	8864-0110	0.250 (6,4)	0.125 (3,2)
	8864-0160	0.312 (7,9)	0.188 (4,8)
M83528/011X004	8864-0120	0.312 (7,9)	0.192 (4,9)
	8864-0144	0.330 (8,4)	0.250 (6,4)
	8864-0050	0.375 (9,5)	0.235 (6,0)
M83528/011X005	8864-0125	0.375 (9,5)	0.250 (6,4)
	8864-0127	0.400 (10,2)	0.200 (5,1)
	8864-0170	0.422 (10,7)	0.319 (8,1)
	8864-0166	0.490 (12,4)	0.414 (10,5)
	8864-0135	0.513 (13,0)	0.438 (11,1)
	8864-0055	0.550 (14,0)	0.447 (11,4)
	8864-0159	0.623 (15,8)	0.366 (9,3)
	8864-0053	0.630 (16,0)	0.375 (9,5)

	8864-010462	0.146 (3,7)	0.091 (2,3)
	8864-3714	0.146 (3,7)	0.055 (1,4)
	8864-0103	0.138 (3,5)	0.071 (1,8)
	8864-0091	0.094 (2,4)	0.059 (1,5)
	8864-3515	0.138 (3,5)	0.059 (1,5)
	8864-2618	0.102 (2,6)	0.071 (1,8)
	8864-3824	0.150 (3,8)	0.094 (2,4)
	8864-0137	0.094 (2,4)	0.035 (0,9)
	8864-0141	0.126 (3,2)	0.087 (2,2)
	8864-0231	0.071 (1,8)	0.039 (1)
	8864-0180	0.063 (1,6)	0.039 (1)
	8864-3715	0.146 (3,7)	0.059 (1,5)

# EXTRUSIONS GUIDE

## D-Strips

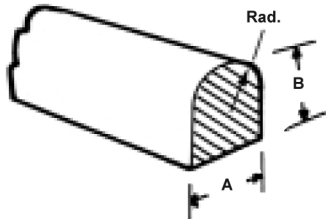

MIL-DTL-83528 PART NUMBER	PART NUMBER	DIMENSIONS			RECOMMENDED GROOVE DIMENSIONS ( $\pm 0.002$ )	
		A	B	RAD	WIDTH	DEPTH
	8865-0100	0.055 (1,4)	0.064 (1,6)	0.031 (0,8)	0.067 (1,7)	0.053 (1,3)
MB83528/003X001	8865-0105	0.062 (1,6)	0.068 (1,7)	0.031 (0,8)	0.074 (1,9)	0.057 (1,4)
MB83528/003X005	8865-0120	0.062 (1,6)	0.100 (2,5)	0.031 (0,8)	0.076 (1,9)	0.084 (2,1)
MB83528/003X010	8865-0140	0.075 (1,9)	0.178 (4,5)	0.089 (2,3)	0.093 (2,4)	0.150 (3,8)
MB83528/003X004	8865-0116	0.093 (2,4)	0.093 (2,4)	0.047 (1,2)	0.109 (2,8)	0.077 (2,0)
MB83528/003X002	8865-0110	0.094 (2,4)	0.078 (2,0)	0.047 (1,2)	0.109 (2,8)	0.065 (1,7)
MB83528/003X008	8865-0135	0.118 (3,0)	0.156 (4,0)	0.059 (1,5)	0.140 (3,6)	0.131 (3,3)
MB83528/003X007	8865-0130	0.122 (3,1)	0.135 (3,4)	0.061 (1,5)	0.141 (3,6)	0.113 (2,9)
MB83528/003X006	8865-0125	0.150 (3,8)	0.110 (2,8)	0.075 (1,9)	0.165 (4,2)	0.092 (2,3)
MB83528/003X003	8865-0115	0.178 (4,5)	0.089 (2,3)	0.039 (1,0)	0.182 (4,3)	0.074 (1,9)
MB83528/003X011	8865-0144	0.188 (4,8)	0.188 (4,8)	0.094 (2,4)	0.220 (5,6)	0.160 (4,1)
MB83528/003X012	8865-0145	0.250 (6,4)	0.250 (6,4)	0.125 (3,2)	0.286 (7,3)	0.212 (5,4)

## Channel Strips

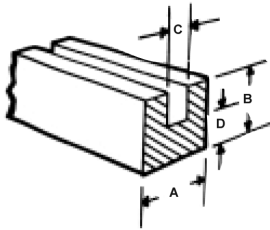

### TOLERANCES ALL PROFILES

DIMENSIONS	TOLERANCE
Under 0.101 (2,6)	$\pm 0.005$ (0,15)
0.101 to 0.200 (2,6 to 5,1)	$\pm 0.008$ (0,2)
0.201 to 0.300 (5,1 to 7,6)	$\pm 0.010$ (0,3)
0.301 to 0.500 (7,6 to 12,7)	$\pm 0.015$ (0,4)
Over 0.500 (12,7)	$\pm 0.020$ (0,5)

MIL-DTL-83528 PART NUMBER	PART NUMBER	DIMENSIONS			
		A	B	C	D
M83528/010X001	8868-0100	0.100 (2,5)	0.100 (2,5)	0.034 (0,9)	0.033 (0,8)
	8868-0055	0.114 (2,9)	0.082 (2,1)	0.030 (0,8)	0.026 (0,7)
M83528/010X002	8868-0105	0.126 (3,2)	0.110 (2,8)	0.025 (0,6)	0.050 (1,3)
M83528/010X003	8868-0056	0.156 (4,0)	0.114 (2,9)	0.030 (0,8)	0.062 (1,6)
M83528/010X004	8868-0115	0.156 (4,0)	0.156 (4,0)	0.062 (1,6)	0.047 (1,2)
	8868-0067	0.175 (4,4)	0.500 (12,7)	0.047 (1,2)	0.075 (1,9)
M83528/010X005	8868-0120	0.175 (4,4)	0.156 (4,0)	0.047 (1,2)	0.075 (1,9)
	8868-0081	0.189 (4,8)	0.189 (4,8)	0.063 (1,6)	0.063 (1,6)
	8868-0084	0.250 (6,4)	0.250 (6,4)	0.062 (1,6)	0.062 (1,6)
	8868-0085	0.252 (6,4)	0.252 (6,4)	0.126 (3,2)	0.063 (1,6)
M83528/010X006	8868-0125	0.327 (8,3)	0.235 (6,0)	0.062 (1,6)	0.115 (2,9)
	8868-0070	0.395 (1,0)	0.120 (3,0)	0.275 (7,0)	0.060 (1,5)
	8868-0075	0.530 (13,5)	0.130 (3,3)	0.390 (9,9)	0.060 (1,5)

# EXTRUSIONS GUIDE

## O-Strips

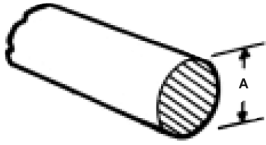

MIL-DTL-85328 PART NUMBER	PART NUMBER	RECOMMENDED GROOVE DIMENSIONS ( $\pm 0.002$ )		
		A	WIDTH	HEIGHT
	8863-0184	0.032 (0,8)	0.036 (0,9)	0.026 (0,7)
M83528/001X001	8863-0100	0.040 (1,0)	0.045 (1,1)	0.032 (0,8)
M83528/001X002	8863-0105	0.053 (1,3)	0.059 (1,5)	0.042 (1,1)
M83528/001X003	8863-0110	0.062 (1,6)	0.066 (1,7)	0.050 (1,3)
M83528/001X004	8863-0115	0.070 (1,8)	0.076 (1,9)	0.056 (1,4)
M83528/001X005	8863-0120	0.080 (2,0)	0.086 (2,2)	0.064 (1,6)
M83528/001X006	8863-0125	0.093 (2,4)	0.100 (2,5)	0.074 (1,9)
	8863-0196	0.098 (2,5)	0.105 (2,7)	0.078 (2,0)
M83528/001X007	8863-0130	0.103 (2,6)	0.110 (2,8)	0.082 (2,1)
	8863-0135	0.112 (2,8)	0.119 (3,0)	0.089 (2,3)
M83528/001X008	8863-0140	0.119 (3,0)	0.126 (3,2)	0.095 (2,4)
M83528/001X009	8863-0145	0.125 (3,2)	0.133 (3,4)	0.100 (2,5)
	8863-0150	0.130 (3,3)	0.137 (3,5)	0.104 (2,6)
M83528/001X010	8863-0160	0.139 (3,5)	0.147 (3,7)	0.111 (2,8)
	8863-0165	0.150 (3,8)	0.158 (4,0)	0.120 (3,0)
	8863-0170	0.160 (4,1)	0.168 (4,3)	0.128 (3,3)
	8863-0197	0.186 (4,7)	0.197 (5,0)	0.149 (3,8)
M83528/001X011	8863-0183	0.188 (4,8)	0.200 (5,1)	0.150 (3,8)
	8863-0198	0.194 (4,9)	0.209 (5,3)	0.156 (4,0)
	8863-0199	0.197 (5,0)	0.210 (5,3)	0.158 (4,0)
M83528/001X0012	8863-0175	0.216 (5,5)	0.229 (5,8)	0.173 (4,4)
M83528/001X013	8863-0180	0.250 (6,4)	0.267 (6,8)	0.200 (5,1)
	8863-0200	0.256 (6,5)	0.274 (7,0)	0.205 (5,2)
	8863-0201	0.312 (7,9)	0.337 (8,6)	0.250 (6,4)
	8863-0202	0.374 (9,5)	0.400 (10,2)	0.300 (7,6)

# EXTRUSIONS GUIDE

## P-Strips

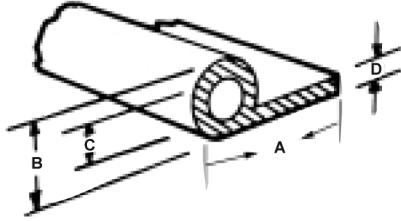

### TOLERANCES ALL PROFILES

DIMENSIONS	TOLERANCE
Under 0.101 (2,6)	± 0.005 (0,15)
0.101 to 0.200 (2,6 to 5,1)	± 0.008 (0,2)
0.201 to 0.300 (5,1 to 7,6)	± 0.010 (0,3)
0.301 to 0.500 (7,6 to 12,7)	± 0.015 (0,4)
Over 0.500 (12,7)	± 0.020 (0,5)

MIL-DTL-83528 PART NUMBER	PART NUMBER	DIMENSIONS			
		A	B	C	D
	8867-0136	0.275 (7,0)	0.140 (3,6)	0.085 (2,2)	0.030 (0,8)
	8867-0147	0.290 (7,4)	0.095 (2,4)	0.062 (1,6)	0.025 (0,6)
	8867-0144	0.390 (9,9)	0.200 (5,1)	0.103 (2,6)	0.062 (1,6)
	8867-0128	0.415 (10,5)	0.200 (5,1)	0.060 (1,5)	0.062 (1,6)
	8867-0141	0.425 (10,8)	0.250 (6,4)	0.151 (3,8)	0.050 (1,3)
M83528/008X007	8867-0101	0.475 (12,1)	0.200 (5,1)	0.080 (2,0)	0.062 (1,6)
	8867-0127	0.500 (12,7)	0.200 (5,1)	0.076 (1,9)	0.062 (1,6)
M83528/008X002	8867-0105	0.500 (12,7)	0.250 (6,4)	0.125 (3,2)	0.062 (1,6)
	8867-0126	0.600 (15,2)	0.250 (6,4)	0.125 (3,2)	0.062 (1,6)
M83528/008X004	8867-0102	0.640 (16,3)	0.208 (5,3)	0.080 (2,0)	0.072 (1,8)
	8867-0158	0.752 (19,1)	0.252 (6,4)	0.189 (4,8)	0.063 (1,6)
	8867-0165	0.752 (19,1)	0.437 (11,1)	0.347 (8,8)	0.060 (1,5)
M83528/008X006	8867-0130	0.780 (19,8)	0.360 (9,1)	0.255 (6,5)	0.070 (1,8)
M83528/008X001	8867-0100	0.850 (21,6)	0.200 (5,1)	0.080 (2,0)	0.062 (1,6)
	8867-0166	0.874 (22,2)	0.500 (12,7)	0.400 (10,2)	0.065 (1,7)
M83528/008X005	8867-0125	0.875 (22,2)	0.312 (7,9)	0.187 (4,8)	0.062 (1,6)

# GEMINI™ COEXTRUSIONS

## MULTI-EXTRUSION, BI-FUNCTIONAL ELASTOMER GASKET

Laird Gemini™ product line is a high-performance gasket solution that combines a reliable environmental silicone elastomer seal with an electrically conductive elastomer. Conductive particle filler results in a product with lower material cost and an improved environmental seal against water, moisture, dust and mildly corrosive atmospheric conditions due to smog.

Our conductive extrusions offer a wide choice of profiles to fit a large range of applications. The cross-sections shown on the following pages are offered as standard. Custom dies can be built to accommodate your specific design.

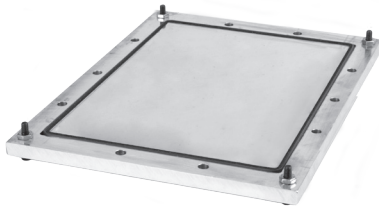

## FEATURES

- Combines the strength of silicone rubber with Laird proprietary conductive elastomer EMI shielding materials and knowledge
- Improved environmental seal
- Improved EMI performance over lifetime
- Cost-effective
- Available in both standard and custom profiles
- Ability to use finite element analysis to design the best custom gasket for your application

## MARKETS

- Wireless infrastructure
- Remote radio units
- Telecom cabinets
- Radar
- IT cabinets
- All electronic cabinets or electronic chassis that require both an environmental seal and EMI shielding

NAME OF MATERIAL	TEST METHOD	NONCONDUCTIVE ELASTOMER		CONDUCTIVE ELASTOMER		TYPICAL CO-GASKET DESIGN	
		NCE220	NCE221	ECE93	ECE81A	NCE220/ECE93, CO-ECE	NCE221/ECE81A, CO-ECE
Polymer matrix		Silicone rubber	Silicone rubber	Silicone rubber	Silicone rubber	Silicone rubber	Silicone rubber
Filler		Alumina	NA	Nickel/graphite (Ni/C)	Ag/Al Compound	Alumina/Ni/C	Ag/Al Compound
Flammability UL94	file E203070	HB	V1(Pending)	HB	Not tested	HB	V1(Pending)
Color	visual	Blue	Orange	Black	Tan	Black & Blue	Tan & Orange
Hardness	ASTM D2240	70 Shore A	60 Shore A	55 Shore A	65 Shore A	NA	NA
Specific gravity	ASTM D792	1.2	1.5	1.9	1.9	NA	NA
Tensile strength	ASTM D412 (modified)	2.8 MPa	3.4 MPa	1.0 MPa	1.7 MPa	NA	NA
Tear strength	GB/T529-91 (modified)		60 ppi, min	30 ppi, min	30 ppi, min	NA	NA
Elongation to break	ASTM D412	100 to 400%	300% ,min	100 to 300%	100 to 300%	100 to 300%	300% ,min
Working temperature range	ASTM D1329	-50 to 150°C	-50 to 150°C	-50 to 150°C	-50 to 150°C	-50 to 150°C	-50 to 150°C
Environmental	EU directive 94/62/EC, Dec 20, 1994	RoHS Compliant	RoHS Compliant	RoHS Compliant	RoHS Compliant	RoHS Compliant	RoHS Compliant
Volume resistivity (max value)	MIL-DTL-83528C (PARA 4.5.10)	Insulator	Insulator	0.100 ohm-cm	0.006 ohm-cm	NA	NA
Aging volume resistivity (max value)	Laird aging test - MIL-DTL-83528C (PARA 4.5.10)	Insulator	Insulator	<0.2 ohm-cm	<0.015 ohm-cm	NA	NA
Mold growth	ASTM G21	0	Not Tested	2	Not Tested	NA	Not Tested
<b>Shielding effectiveness (dB)*</b>							
100 MHz (E-field)	MIL-DTL-83528C (PARA 4.5.12) MIL-STD 285	NA	NA	100 dB	100 dB	90 dB	100 dB
500 MHz (E-field)		NA	NA	100 dB	100 dB	90 dB	100 dB
2 GHz (Plane Wave)		NA	NA	100 dB	100 dB	80 dB	95 dB
10 GHz (Plane Wave)		NA	NA	100 dB	100 dB	80 dB	90 dB

Adhesive available upon request for ease of installation



# GEMINI COEXTRUSIONS

## M

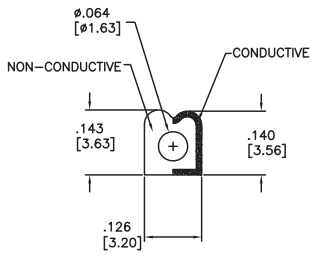

8890-MGS103072-93

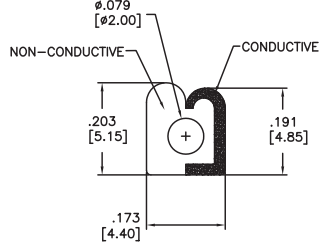

8890 0001 XX A

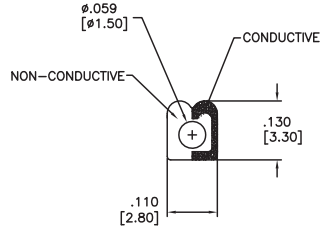

8890 0002 XX A

## D

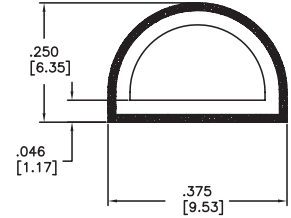

8894 0001 XX A

## DD

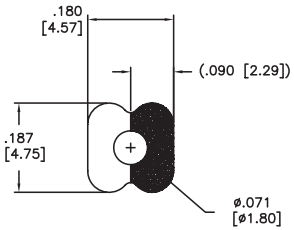

8898 0001 XX A

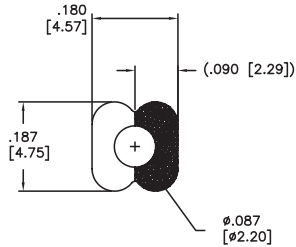

8898 0002 XX A

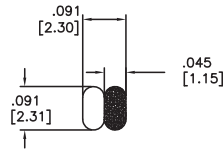

8899 0001 XX A

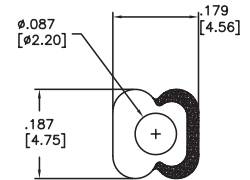

8898 0003 XX A

# FABRICATED COMPONENTS GUIDE

## Molded EMI O-Rings

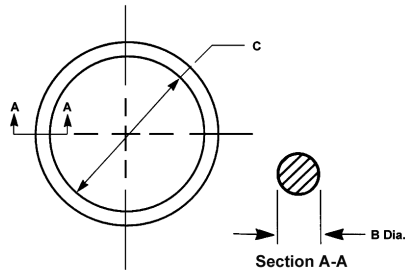

### TOLERANCES: TABLE 1 AND TABLE 2

INNER DIMENSIONS : C	TOLERANCES
0.100 to 1.500 (3 to 38)	± 0.010 (0,3)
1.501 to 2.500 (38 to 64)	± 0.015 (0,4)
2.501 to 4.500 (64 to 114)	± 0.020 (0,5)
4.501 to 7.000 (114 to 178)	± 0.025 (0,6)
over 7.000 (178)	± 0.35% nom. dim.

CROSS SECTION DIMENSIONS : B	TOLERANCES
0.000 to 0.070 (0,0 to 1,8)	± 0.003 (0,1)
0.071 to 0.200 (1,8 to 5,1)	± 0.005 (0,1)
0.201 to 0.400 (5,1 to 10,2)	± 0.006 (0,2)

TABLE 1. MIL-DTL-83528 SERIES

MIL-DTL-83528 PART NO.	LAIRD PART NO	DIMENSIONS		MIL-DTL-83528 PART NO.	LAIRD PART NO	DIMENSIONS	
		C	B			C	B
	8563-0322-XX	0.050 (1,3)	0.063 (1,6)		8563-0218-XX	0.755 (19,2)	0.097 (2,5)
M83528/002X007	8563-0068-XX	0.145 (3,7)	0.070 (1,8)	M83528/002X019	8563-0076-XX	0.801 (20,3)	0.070 (1,8)
	8563-0143-XX	0.150 (3,8)	0.062 (1,6)	M83528/002X020	8563-0077-XX	0.864 (21,9)	0.070 (1,8)
	8563-0334-XX	0.176 (4,5)	0.070 (1,8)		8563-0344-XX	0.921 (23,4)	0.139 (3,5)
	8563-0326-XX	0.260 (6,6)	0.030 (0,8)	M83528/002X021	8563-0078-XX	0.926 (23,5)	0.070 (1,8)
	8563-0343-XX	0.270 (6,9)	0.070 (1,8)	M83528/002X022	8563-0079-XX	0.989 (25,1)	0.070 (1,8)
M83528/005X006	8563-0106-XX	0.295 (7,5)	0.048 (1,2)		8563-0213-XX	0.989 (25,1)	0.070 (1,8)
M83528/002X011	8563-0069-XX	0.301 (7,6)	0.070 (1,8)		8563-0279-XX	1.000 (25,4)	0.250 (6,4)
M83528/002X012	8563-0070-XX	0.364 (9,2)	0.070 (1,8)		8563-0062-XX	1.100 (27,9)	0.070 (1,8)
	8563-0243-XX	0.415 (10,5)	0.057 (1,4)	M83528/002X024	8563-0080-XX	1.114 (28,3)	0.070 (1,8)
M83528/002X013	8563-0071-XX	0.426 (10,8)	0.070 (1,8)	M83528/005X013	8563-0113-XX	1.182 (30,0)	0.068 (1,7)
M83528/005X008	8563-0108-XX	0.446 (11,3)	0.051 (1,3)	M83528/002X026	8563-0089-XX	1.239 (31,5)	0.070 (1,8)
M83528/002X014	8563-0072-XX	0.489 (12,4)	0.070 (1,8)		8563-0161-XX	1.239 (31,5)	0.070 (1,8)
	8563-0196-XX	0.492 (12,5)	0.070 (1,8)	M83528/002X126	8563-0094-XX	1.362 (34,6)	0.103 (2,6)
	8563-0327-XX	0.500 (12,7)	0.100 (2,5)	M83528/002X028	8563-0090-XX	1.364 (34,6)	0.070 (1,8)
M83528/002X015	8563-0073-XX	0.551 (14,0)	0.070 (1,8)		8563-0165-XX	1.366 (34,7)	0.070 (1,8)
M83528/005X016	8563-0116-XX	0.610 (15,5)	0.070 (1,8)		8563-0324-XX	1.463 (37,2)	0.080 (2,0)
M83528/002X114	8563-0091-XX	0.612 (15,5)	0.103 (2,6)	M83528/002X128	8563-0095-XX	1.487 (37,8)	0.103 (2,6)
	8563-0285-XX	0.632 (16,1)	0.062 (1,6)		8563-0164-XX	1.487 (37,8)	0.103 (2,6)
M83528/002X017	8563-0074-XX	0.676 (17,2)	0.070 (1,8)		8563-0166-XX	1.489 (37,8)	0.070 (1,8)
	8563-0211-XX	0.676 (17,2)	0.070 (1,8)	M83528/005X022	8563-0122-XX	1.612 (40,9)	0.103 (2,6)
M83528/002X018	8563-0075-XX	0.739 (18,8)	0.070 (1,8)	M83528/002X132	8563-0096-XX	1.737 (44,1)	0.103 (2,6)

## Flat Washer Gaskets

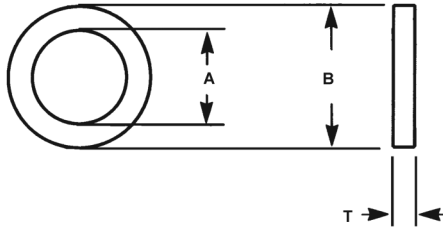

## TOLERANCES (ALL DIMENSIONS)

DIMENSIONS	TOLERANCE
Under 0.101 (0,0 to 2,6)	± 0.005 (0,1)
0.101 to 0.200 (2,6 to 5,1)	± 0.010 (0,3)
0.201 to 0.500 (5,1 to 12,7)	± 0.015 (0,4)
Over 0.500 (12,7)	± 0.020 (0,5)

TABLE 3. MIL-DTL-83528 SERIES

MIL-DTL-83528 PART NO.	LAIRD PART NO.	DIMENSIONS		
		A	B	T
	8560-0231-XX	0.120 (3,0)	0.260 (6,6)	0.030 (0,8)
	8560-0234-XX	0.171 (4,3)	0.390 (9,9)	0.060 (1,5)
	8560-0233-XX	0.218 (5,5)	0.468 (11,9)	0.030 (0,8)
M83528/012X001	8560-0097-XX	0.250 (6,4)	0.625 (15,9)	0.032 (0,8)
M83528/012X002	8560-0158-XX	0.250 (6,4)	0.562 (14,3)	0.060 (1,5)
	8560-0435-XX	0.250 (6,4)	0.750 (19,1)	0.032 (0,8)
	8560-0299-XX	0.319 (8,1)	0.422 (10,7)	0.075 (1,9)
M83528/012X004	8560-0143-XX	0.375 (9,5)	0.750 (19,1)	0.062 (1,6)
M83528/012X003	8560-0098-XX	0.375 (9,5)	0.750 (19,1)	0.031 (0,8)
	8560-0331-XX	0.375 (9,5)	0.750 (19,1)	0.032 (0,8)
	8560-0444-XX	0.380 (9,7)	0.960 (24,4)	0.065 (1,7)
	8560-0200-XX	0.433 (11,0)	0.508 (12,9)	0.045 (1,1)
M83528/012X005	8560-0099-XX	0.500 (12,7)	0.656 (16,7)	0.031 (0,8)
M83528/012X007	8560-0100-XX	0.500 (12,7)	0.875 (22,2)	0.031 (0,8)
M83528/012X006	8560-0144-XX	0.500 (12,7)	0.656 (16,7)	0.062 (1,6)
M83528/012X008	8560-0145-XX	0.500 (12,7)	0.875 (22,2)	0.062 (1,6)
	8560-0330-XX	0.500 (12,7)	0.656 (16,7)	0.032 (0,8)
	8560-0311-XX	0.641 (16,3)	0.703 (17,9)	0.032 (0,8)
	8560-0505-XX	0.800 (20,3)	1.000 (25,4)	0.156 (4,0)
	8560-0453-XX	0.890 (22,6)	1.250 (31,8)	0.062 (1,6)

# FABRICATED COMPONENTS GUIDE

## Molded Waveguide Gaskets

### TOLERANCES "D" SECTION PROFILES

DIMENSIONS	TOLERANCE
Under 0.101 (2,6)	± 0.005 (0,1)
0.101 to 0.200 (2,6 to 5,1)	± 0.008 (0,2)
0.201 to 0.300 (5,1 to 7,6)	± 0.010 (0,3)
0.301 to 0.500 (7,6 to 12,7)	± 0.015 (0,4)
Over 0.500 (12,7)	± 0.020 (0,5)

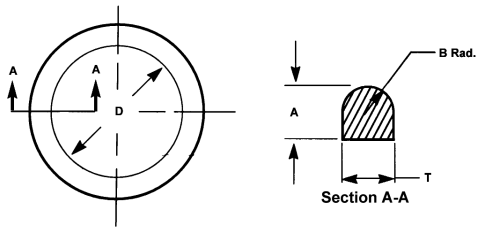

TABLE 4. CIRCULAR "D" SECTION

MIL-DTL-83528 PART NO.	LAIRD PART NO.	NOMINAL DIMENSIONS			
		A	B	D	T
M83528/013X002	8563-0126-XX	0.056 (1,4)	0.041 (1,0)	0.410 (10,4)	0.082 (2,1)
M83528/013X004	8563-0127-XX	0.048 (1,2)	Full Radius	0.587 (14,9)	0.078 (2,0)
M83528/013X006	8563-0128-XX	0.125 (3,2)	Full Radius	0.885 (22,5)	0.155 (3,9)
M83528/013X008	8563-0129-XX	0.065 (1,7)	0.049 (1,2)	1.122 (28,5)	0.099 (2,5)
M83528/013X011	8563-0131-XX	0.088 (2,2)	Full Radius	1.340 (34,0)	0.095 (2,4)
M83528/013X012	8563-0130-XX	0.077 (2,0)	Full Radius	1.310 (33,3)	0.115 (2,9)
M83528/013X017	8563-0133-XX	0.078 (2,0)	Full Radius	1.550 (39,4)	0.105 (2,7)

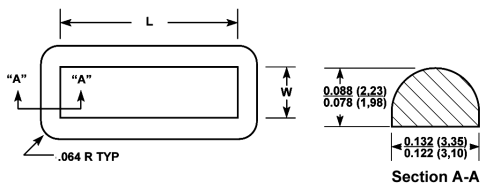

TABLE 5. RECTANGULAR "D" SECTION

MIL-DTL-83528 PART NO.	LAIRD PART NO.	WIDTH DIMENSIONS		LENGTH DIMENSIONS	
		MIN	MAX	MIN	MAX
M83528/006X001	8563-0253-XX	0.285 (7,2)	0.295 (7,5)	0.983 (25,0)	0.993 (25,2)
M83528/006X002	8563-0254-XX	0.485 (12,3)	0.495 (12,6)	0.983 (25,0)	0.993 (25,2)
M83528/006X003	8563-0255-XX	0.619 (15,7)	0.629 (16,0)	1.243 (31,6)	1.243 (31,6)
M83528/006X005	8563-0257-XX	1.325 (33,7)	1.355 (34,4)	5.265 (133,7)	5.295 (134,5)

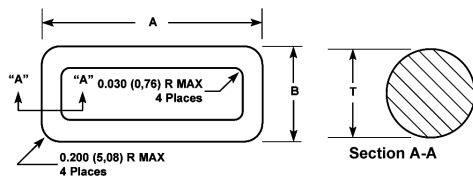

TABLE 6. RECTANGULAR "O" SECTION

MIL-DTL-83528 PART NO.	LAIRD PART NO.	DIMENSIONS		
		A	B	T
M83528/013X013	8563-0248-XX	1.368 (34,7) ± 0.012 (0,3)	0.868 (22,0) ± 0.010 (0,3)	0.103 (2,6) ± 0.003 (0,1)
M83528/013X018	8563-0249-XX	1.616 (41,0) ± 0.015 (0,4)	0.991 (25,2) ± 0.010 (0,3)	0.103 (2,6) ± 0.003 (0,1)
M83528/013X023	8563-0250-XX	11.866 (301,4) ± 0.015 (0,4)	1.116 (28,3) ± 0.012 (0,3)	0.103 (2,6) ± 0.003 (0,1)
M83528/013X030	8563-0251-XX	2.449 (62,2) ± 0.020 (0,5)	1.449 (36,8) ± 0.013 (0,3)	0.139 (3,5) ± 0.004 (0,1)
M83528/013X037		3.451 (87,7) ± 0.024 (0,6)	1.951 (49,6) ± 0.004 (0,1)	0.139 (3,5) ± 0.004 (0,1)

## Rectangular Waveguide Gaskets

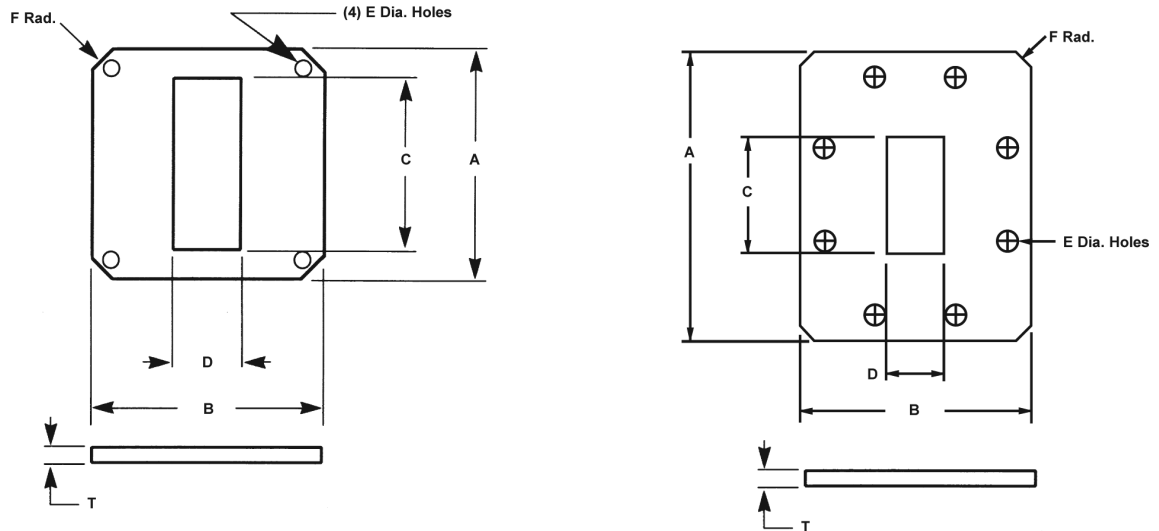

TABLE 7.

MIL-DTL-83528 PART NO.	LAIRD PART NO.	DIMENSIONS						
		A	B	C	D	E	T	F RADIUS
M83528/013X001	8560-0104-XX Fig. 1	± 0.750 (19,1)	± 0.750 (19,1)	± 0.145 (3,7)	± 0.285 (7,2)	± 0.116 (2,9)	± 0.027 (0,7)	± 0.469 (11,9)
M83528/013X003	8560-0105-XX Fig. 1	0.875 (22,2)	0.875 (22,2)	0.175 (4,4)	0.425 (10,8)	0.116 (2,9)	0.027 (0,7)	0.563 (14,3)
M83528/013X005	8560-0106-XX Fig. 1	1.313 (33,4)	1.313 (33,4)	0.630 (16,0)	0.320 (8,1)	0.140 (3,6)	0.027 (0,7)	0.875 (22,2)
M83528/013X007	8560-0103-XX Fig. 1	1.496 (38,0)	1.496 (38,0)	0.760 (19,3)	0.385 (9,8)	0.155 (3,9)	0.027 (0,7)	0.450 (11,4)
M83528/013X009	8560-0107-XX Fig. 1	1.625 (41,3)	1.625 (41,3)	0.905 (23,0)	0.405 (10,3)	0.169 (4,3)	0.027 (0,7)	0.469 (11,9)
M83528/013X015	8560-0108-XX Fig. 1	1.875 (47,6)	1.875 (47,6)	1.130 (28,7)	0.505 (12,8)	0.180 (4,6)	0.027 (0,7)	1.150 (29,2)
M83528/013X016	8560-0113-XX Fig. 2	1.750 (44,5)	2.500 (63,5)	0.505 (12,8)	1.130 (28,7)	0.171 (4,3)	0.027 (0,7)	0.250 (6,4)
M83528/013X020	8560-0114-XX Fig. 2	1.937 (49,2)	2.687 (68,3)	0.633 (16,1)	1.380 (35,1)	0.206 (5,2)	0.027 (0,7)	0.250 (6,4)
M83528/013X027	8560-0116-XX Fig. 2	3.500 (88,9)	2.500 (63,5)	1.880 (47,8)	0.880 (22,4)	0.226 (5,7)	0.027 (0,7)	0.313 (8,0)
M83528/013X028	Fig. 2	1.764 (44,8)	2.781 (70,6)	0.882 (22,4)	1.882 (47,8)	0.156 (4,0) 0.141	0.027 (0,7)	0.125 (3,2)
M83528/013X031	Fig. 2	2.750 (69,9)	3.875 (98,4)	1.155 (29,3)	2.300 (58,4)	0.270 (6,9)	0.027 (0,7)	0.312 (7,9)
M83528/013X040	8560-0110-XX Fig. 2	4.188 (106,4)	6.344 (161,1)	2.160 (54,9)	4.310 (109,5)	0.266 (6,8) 0.281 (7,1)	0.027 (0,7)	0.250 (6,4)

Note: Compound 98 is silicone material filled with Ag/Cu and expanded metal. See Material Compounds chart on

# METAL IMPREGNATED MATERIALS

## ELECTROMET™ ORIENTED WIRE

ElectroMet oriented wire gaskets are EMI shielding and sealing composites. Monel® or aluminum wires embedded in the elastomer and oriented perpendicular to the mating surfaces provide the EMI sealing. Solid or sponge silicone provides the weather sealing; however, solid silicone weather seals are recommended for high-pressure applications.

Silicone based oriented wire composites are capable of withstanding temperature ranges from  $-70^{\circ}\text{F}$  to  $500^{\circ}\text{F}$  ( $-56^{\circ}\text{C}$  to  $260^{\circ}\text{C}$ ). Oriented wire materials are available in sheet or strip form with a minimum thickness of 0.032 in. (0,8 mm). Material specifications and information for standard sheets and strips are provided in Tables 1 through 3.

TABLE 1.

MATERIAL CODE	ELASTOMER	WIRE SPECIFICATION
55	Silicone Sponge Per AMS 3195	Monel: Alloy Per QQ N281 Dia. 0.0045 (0,114)
56	Silicone Solid Per ZZR765 Class 2b Grade 40	Monel: Alloy Per QQ N281 Dia. 0.0045 (0,114)
58	Silicone Sponge Per AMS 3195	Aluminum: Alloy 5056 Per AMS 4182 Dia. 0.005 (0,127)
59	Silicone Solid Per ZZR765 Class 2b Grade 40	Aluminum: Alloy 5056 Per AMS 4182 Dia. 0.005 (0,127)

Note: Wire density per sq. in.: 700–900; per sq. cm 108–139  
55 not available in thickness below .062"



TABLE 2. ELECTROMET SHEET MATERIALS

END VIEW	PART NO.	DIMENSIONS	
		A. WIDTH	B. THICKNESS
	8408-0200-XX	3.000 (76,2)	0.032 (0,8)
	8408-0203-XX	3.000 (76,2)	0.045 (1,1)
	8408-0206-XX	3.000 (76,2)	0.062 (1,6)
	8408-0209-XX	3.000 (76,2)	0.093 (2,4)
	8408-0212-XX	3.000 (76,2)	0.125 (3,2)
	8408-0213-XX	3.000 (76,2)	0.187 (4,8)
	8408-0215-XX	4.500 (114,3)	0.032 (0,8)
	8408-0218-XX	4.500 (114,3)	0.045 (1,1)
	8408-0221-XX	4.500 (114,3)	0.062 (1,6)
	8408-0227-XX	4.500 (114,3)	0.125 (3,2)
	8408-0230-XX	6.000 (152,4)	0.032 (0,8)
	8408-0242-XX	6.000 (152,4)	0.125 (3,2)
	8408-0245-XX	9.000 (228,6)	0.032 (0,8)
	8408-0248-XX	9.000 (228,6)	0.045 (1,1)
	8408-0251-XX	9.000 (228,6)	0.062 (1,6)
	8408-0254-XX	9.000 (228,6)	0.093 (2,4)
	8408-0257-XX	9.000 (228,6)	0.125 (3,2)

## HOW TO SPECIFY

- For PSA, change the fifth digit to 9 for items with tape.  
Example: 8408-0200-59 becomes 8408-9200-59.
- Replace XX with material code from Table 1.  
Example: To request a 3.0 in. (76,2 mm) wide x 0.032 in. (0,8 mm) thick strip with aluminum wire in solid silicone sponge, use 8408-0200-59.

For further information or for product samples, please contact Laird sales department.

# METAL IMPREGNATED MATERIALS

## DIE-CUT GASKET

Oriented wire can be supplied as a die-cut gasket in various configurations. Gasket sizes are available up to 9 in. (228,6 mm) X 36 in. (914,4 mm). Several of the most common die-cut gaskets are for cable connectors and Sub-D connectors shown in Figures 2a and 2b.

FIGURE 2A. CABLE CONNECTOR

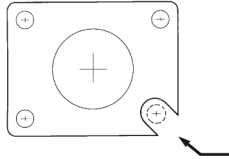

Corner holes may be slotted at Laird option

FIGURE 2B. SUB-D CONNECTOR

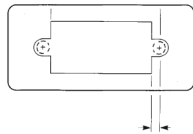

Holes closer to edges than 2x material thickness will be made as "u" slots at Laird option

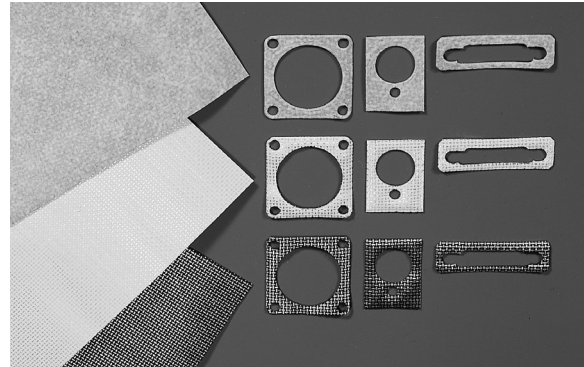

## ELECTROMET IMPREGNATED WOVEN WIRE AND EXPANDED METAL

ElectroMet impregnated wire mesh and expanded metal gaskets are available in thin sheet form. EMI shielding is provided by woven aluminum mesh or expanded metals. Pressure sealing is provided by neoprene or silicone elastomer impregnated in the mesh. Fluorosilicone is also available for specific applications that require resistance to oils, hydraulic fluids and hydrocarbon fuels.

TABLE 1. MATERIAL SELECTION

PART NO.	THICKNESS FILLER	WIDTH	MATERIAL DESCRIPTION	MATERIAL SPECIFICATIONS		
				METAL FILLER	ELASTOMER FILLER	COLOR
8416-0120-57	0.020 ± 0.004 (0,5 ± 0,1)	8.0 (203,2)	Woven Wire Neoprene Impregnated	Aluminum 5056 Alloy Per AMS 3222	Neoprene Per AMS 4182	Black
8416-0120-23	0.020 ± 0.004 (0,5 ± 0,1)	8.0 (203,2)	Woven Wire Silicone Impregnated	Aluminum 5056 Alloy Per AMS 4182	Silicone Per ZZR 765, Class 2B, Grade 50	Gray
8416-0320-21	0.020 ± 0.004 (0,5 ± 0,1)	8.0 (203,2)	Expanded Metal with Elastomer	Aluminum 5056 Alloy Per AMS 4182	Silicone Per ZZR 765, Class 2B, Grade 50	Gray
8416-0330-21	0.030 ± 0.004 (0,8 ± 0,1)					
8416-0320-22	0.020 ± 0.004 (0,5 ± 0,1)	8.0 (203,2)	Expanded Metal with Elastomer	Monel® per QQ-N-281B	Silicone Per ZZR 765, Class 2B, Grade 50	Gray
8416-0330-22	0.030 ± 0.004 (0,8 ± 0,1)					

# METAL IMPREGNATED MATERIALS

## MIL CONNECTOR GASKETS

Laird offers a broad range of EMI gasket materials to fit the shell sizes of standard MIL connectors.

- Gaskets are available in a wide range of materials that can provide shielding or a combination of RF shielding and environmental sealing
- Standardized to fit all MIL connectors
- Test results indicate shielding effectiveness of 100 dB or greater for these connector gaskets

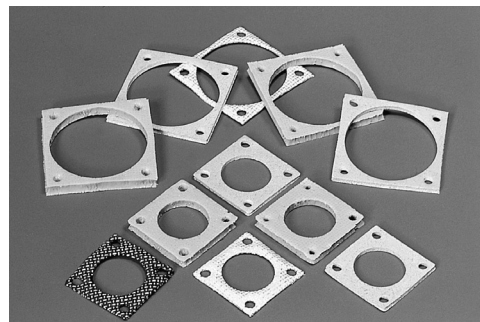

TABLE 1. MATERIAL SELECTION GUIDE

MATERIAL SPECIFICATIONS						MATERIAL CHARACTERISTICS LEGEND: G = GOOD F = FAIR P = POOR								
MATERIAL CODE	MATERIAL DESCRIPTION	METAL FILLER	ELASTOMER FILLER	COLOR	THICKNESS	SHIELDING EFFECTIVENESS	SEAL DRIP PROOF	FLUIDS JP4 HYDRAUL	SALT FOG	OUTER SPACE	TEMP -40°F +250°F	TEMP -65°F +500°F	SURFACE FLATNESS <0.010	SURFACE FLATNESS >0.010
57	Woven Wire Neoprene Impregnated	Aluminum Alloy 5056 Per AMS 4182	Neoprene Per AMS 3222	Black	0.020 ± 0.004 (0,5 ± 0,1)	F	P	P	P	F	G	P	F	P
23	Woven Wire Silicone Impregnated	Aluminum Alloy 5056 Per AMS 4182	Silicone Per ZZR 765, Glass 2B, Grade 50	Gray	0.020 ± 0.004 (0,5 ± 0,1)	F	P	P	P	F	G	G	F	P
56	Oriented Wire in Solid Silicone	Monel® Alloy Per QQN 281	Silicone Per ZZR 765, Class 2B, Grade 50	Gray	0.062 ± 0.005 (0,8 ± 0,1)	G	G	P	F	F	G	G	G	G

## HOW TO SPECIFY

1. From Table below, match base part number to shell size used.
2. From Table 1, determine material code based on characteristics which best meet design requirements.
3. Insert material code in place of the XX from base part number.

Example: Base part number for shell size F in Table below is 8516-0210-XX; material code chosen from Table 1 is -57; part number is 8516-0210-57.

## “D” Subminiature Connector Shields

- Available in 9 pin to 50 pin “D” Connector styles
- Versatile front or rear mounting
- Custom shapes and designs available

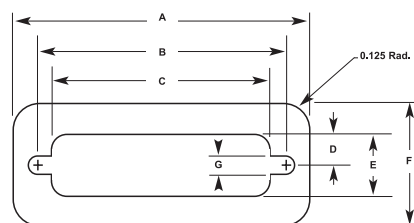

## “D” CONNECTOR SERIES DIMENSIONS FOR ELASTOMERS

PART NO.	THICKNESS	# PINS	A	B	C	D	E	F	G
TOLERANCE:			± 0.015 (0,4)	± 0.010 (0,2)	± 0.015 (0,4)	REF	± 0.010 (0,3)	± 0.015 (0,4)	± 0.010 (0,3)
8516-0208-XX	0.030 (0,8)	9	1.410	0.980	0.780	0.220	0.440	0.690	0.130
8516-0201-XX	0.060 (1,5)		(35,8)	(24,9)	(19,8)	(5,6)	(11,2)	(17,5)	(3,3)
8516-0209-XX	0.030 (0,8)	15	1.740	1.310	1.110	0.220	0.440	0.690	0.130
8516-0203-XX	0.060 (1,5)		(44,2)	(33,3)	(28,2)	(5,6)	(11,2)	(17,5)	(3,3)
8516-0210-XX	0.030 (0,8)	25	2.280	1.850	1.650	0.220	0.440	0.690	0.130
8516-0211-XX	0.030 (0,8)	37	2,930	2.500	2.290	0.220	0.440	0.690	0.130
8516-0204-XX	0.060 (1,5)		(74,4)	(63,5)	(58,2)	(5,6)	(11,2)	(17,5)	(3,3)
8516-0212-XX	0.030 (0,8)	50	2.840	2.410	2.110	0.280	0.550	0.800	0.240
8516-0205-XX	0.060 (1,5)		(72,1)	(61,2)	(53,6)	(7,1)	(14,0)	(20,3)	(6,1)

To order replace XX with material code from the Material Compounds chart on page 101.



# SPECIALTY PRODUCTS

## ELECTROCOAT™

ElectroCoat is a thin, flexible surface coating consisting of a silver-filled silicone elastomer. The versatile coating can be easily applied to die-cut or molded foams for both gasket and non-gasket applications. It can also be applied to molded or extruded elastomers, other polymers, and a wide range of other materials.

- Excellent shielding effectiveness — greater than 90 dB measured by transfer impedance
- Solid, continuous, conductive coating over the entire gasket surface, including the inner die-cut surfaces of foam gaskets
- Coated foam gaskets have very low compression force
- Exceptionally wide compression range from 10% to 70% deflection to accommodate uneven gaps in enclosure housings
- Flexible coating withstands gasket compression with no decrease in shielding effectiveness after 1000 cycles of 40% compression
- Extruded profiles shown on pages 87-92 are available with neoprene core.

## ORDERING INFORMATION

1. Determine if PSA is needed. If so, replace the 5th digit in the part number with "9".
2. Select desired core material from Table 1 and insert in place of YY.
3. Select two digit ElectroCoat from Table 2 and insert in place of ZZ.
4. A unique custom identification number will be assigned by sales.

8550	-X	XXX	-YY	-ZZ
Standard Series Number	9 w/PSA	Unique identification number assigned by Laird	Core Material*	ElectroCoat (Coating Material)

TABLE 1

YY #	CORE MATERIAL*
50	Silicone Foam
51	Solid Silicone
52	Neoprene Foam

TABLE 2

ZZ COATING #	MATERIAL
10	Silver/Silicone

\*Other core materials may be available. Consult Laird sales department.

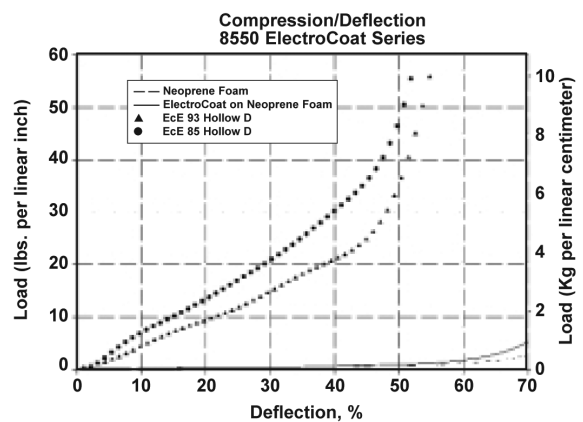
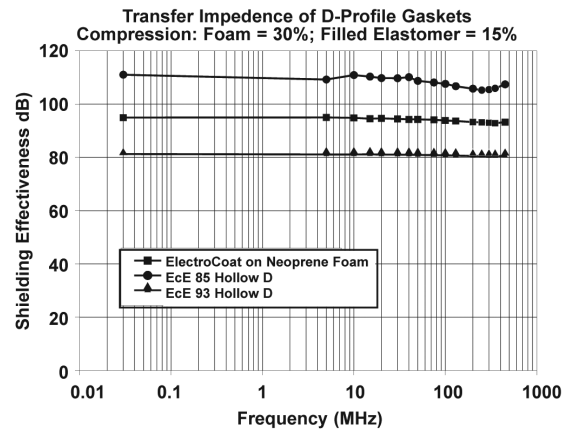
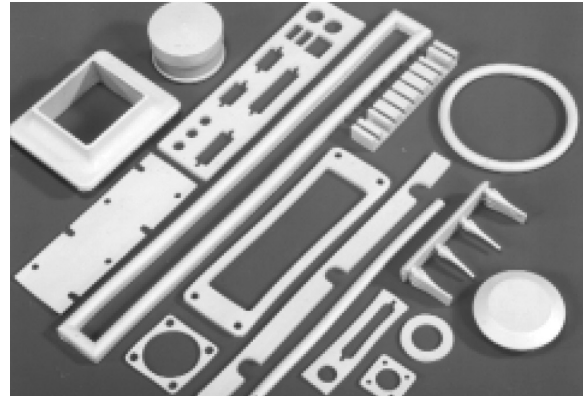

# AUTOMATED FORM-IN-PLACE EMI GASKET TECHNOLOGIES

## INTRODUCTION

Laird form-in-place is an automated system for dispensing conductive elastomer EMI shielding and grounding gaskets onto metal or plastic substrates. Form-in-place is particularly well suited for cellular phones, PDAs, PC cards, telecom base stations, radios, and many other compartmentalized cast or plastic enclosures and packaged electronic assemblies.

Utilizing programmable 3-axis CNC dispensing equipment, the compound is dispensed accurately onto the substrate and creates a secure bond during the curing process. The repeatable computer-controlled dispensing pattern insures consistency between parts and rapid part program changes. In addition, it supports all levels of volume – from prototyping to high-volume electronic component production – via the use of one or multiple dispensing heads. The system is programmed to apply custom gasket configurations onto parts, to form multiple levels on the part, and on slopes up to approximately 70°.

Laird RXP compounds are Room Temperature Vulcanizing (RTV) elastomers and HXP compounds are High Temperature Vulcanizing (HTV) elastomers, both filled with proprietary conductive particles. Dispensed gasket beads of RXP compounds may be handled in 3 hours, and are cured in 24 hours, under conditions of standard temperature and 50% Relative Humidity. Dispensed gasket beads of HXP compounds can be handled after the materials are cured in an oven. The compounds have a working compression range from 10% to 50% of the gasket height, with a recommended design compression of 30% against a mechanical compression stop. Our product is designed to support low closure forces and is compatible with plastic, metal, and plated or chromate finished substrates.

The required force to compress a given bead is a function of the compound and the gasket size; i.e. smaller gaskets require less force than larger gaskets. Please refer to our technical data for details. Gaskets are dispensed on substrates within a placement tolerance of  $\pm 0.001$  inches and gasket cross-sectional tolerances from  $\pm 0.003$  to 0.007 inches. Refer to Table 1 on page 104 for typical gasket dimensions and tolerances. As a normal course of equipment operations, starting points and termination ends of the gaskets will have profiles that are approximately 25% larger than the running gaskets.

## TYPICAL APPLICATION FOR FORM-IN-PLACE GASKETS:

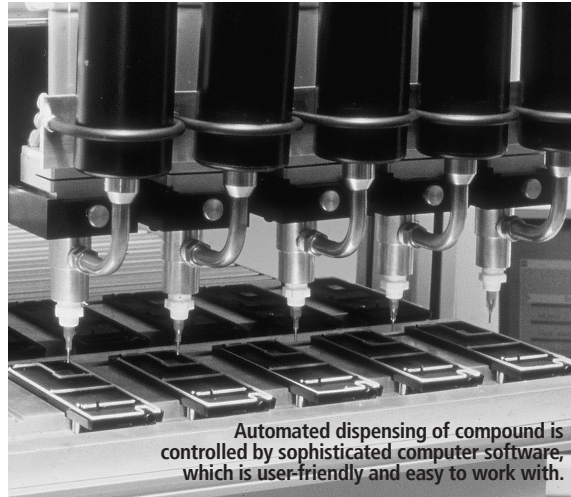
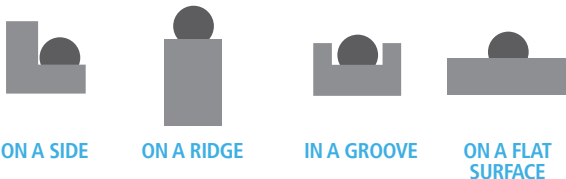

Automated dispensing of compound is controlled by sophisticated computer software, which is user-friendly and easy to work with.

## FORM-IN-PLACE GASKETING FEATURES AND BENEFITS

- Form-in-place gasketing offers a total cost savings in the form of reduced raw materials, labor or assembly time
- Room temperature cure gasketing materials eliminate the need for costly heat curing systems, allowing the use of inexpensive plastic or metal substrates
- Single-component compounds eliminate the need for mixing ingredients, thereby shortening production cycles and eliminating related waste
- Easy to program operating system allows for quick part-to-part change-over, minimal tooling investment for new designs, and prototype development in 24 to 48 hours
- High shielding effectiveness: 85–100 dB up to 10 GHz
- The dispensing system supports prototyping and high volume production schedules in a space saving 4' x 3' [12 sq. ft.] (1,2 m x 0,9 m [1,1 sq. m]) footprint
- Form-in-place gaskets provide more critical packaging space for board level components and smaller package dimensions
- Excellent adhesion on a wide variety of metal and plastic substrates including:
  - aluminum and other casting alloys
  - stainless steel
  - nickel copper plating (on plastics)
  - copper, silver, and nickel filled paint (on plastics)
- Low compression force makes SN compounds an excellent selection where the mating surfaces lack mechanical stiffness

# AUTOMATED FORM-IN-PLACE EMI GASKET TECHNOLOGIES

**TABLE 1.  
TYPICAL BEAD DIMENSIONS**

HEIGHT	WIDTH	MINIMUM LANDING AREA
0.014 ± 0.003 (0,4 ± 0,1)	0.015 ± 0.003 (0,4 ± 0,1)	0.020 (0,5)
0.015 ± 0.003 (0,4 ± 0,1)	0.020 ± 0.003 (0,5 ± 0,1)	0.025 (0,6)
0.020 ± 0.003 (0,5 ± 0,1)	0.024 ± 0.003 (0,6 ± 0,1)	0.029 (0,7)
0.027 ± 0.004 (0,7 ± 0,1)	0.030 ± 0.004 (0,8 ± 0,1)	0.036 (0,9)
0.030 ± 0.004 (0,8 ± 0,1)	0.034 ± 0.004 (0,9 ± 0,1)	0.040 (1,0)
0.040 ± 0.004 (1,0 ± 0,1)	0.048 ± 0.005 (1,2 ± 0,1)	0.055 (1,4)
0.045 ± 0.005 (1,1 ± 0,1)	0.059 ± 0.006 (1,5 ± 0,2)	0.067 (1,7)
0.055 ± 0.006 (1,4 ± 0,2)	0.075 ± 0.007 (1,9 ± 0,2)	0.084 (2,1)

**TABLE 2.  
ACCELERATED CURE AT HIGHER TEMPERATURES**

CONDITIONS	50%RELATIVE HUMIDITY, 0.024 IN. (0,6 MM) BEAD		
	73 (23)	140 (60)	185 (85)
Temperature °F (°C)			
Time for 98% Cure (Hr.)	12	2	1

**TABLE 3. MATERIAL SPECIFICATIONS**

	TEST METHOD	UNIT	SNC70-RXP	SNK55-RXP	SNL60-RXP	SNN60-RXP	SIL25-RXP	SNC70-HXP	SNK60-HXP	SNL70-HXP	SNN65-HXP	SIL35-HXP
Elastomer			Silicone	Silicone	Silicone	Silicone	Silicone	Silicone	Silicone	Silicone	Silicone	Silicone
Filler			Nickel/ Graphite	Silver/ Copper	Silver/ Aluminium	Silver/ Nickel	Non- conductive	Nickel/ Graphite	Silver/ Copper	Silver/ Aluminium	Silver/ Nickel	Non- Conductive
Color			Gray	Tan	Tan	Tan	White	Gray	Tan	Tan	Tan	Transparent
<b>Electric Properties</b>												
Volume Resistivity		ohm- cm	0.03	0.002	0.003	0.005	NA	0.03	0.004	0.005	0.005	NA
Shielding effectiveness	MIL-DTL- 83528C											
200 MHz to 10 GHz	Para. 4.5.12	dB	>100	>90	>100	>100	NA	>90	>90	>90	>100	NA
<b>Mechanical Properties</b>												
Hardness	ASTM D2240	Shore A	70	55	60	60	25	70	60	70	65	35
Density (cured)	ASTM D792	g/cm <sup>3</sup>	2.5	3	2.1	3.9	1.2	2.5	3.1	2	3.84	1.1
Compression set	ASTM D395	%	15	10	10	15	<20(a)	15	10	10	10(b)	<20(b)
Adhesion strength (Al)	LT-FIP-CLE-03	N/cm <sup>2</sup>	150	200	140	180	220	>180	200	200	200	285
Compression deflection	LT-FIP-CLE-07											
at 20% compression		lb/in	1.5	1.2	1.9	1.7	See note (b)	3.2	1.5	2.3		See note (c)
at 40% compression		lb/in	6.9	5.2	8.3	6.4		11.5	7.3	10.5		
Temperature Range		°C	-50 to 125	-50 to 100	-50 to 125	-50 to 125	See note (b)	-50 to 125	-50 to 125	-50 to 125	-50 to 125	See note (c)
UL rating	UL-94		V0	V0	V0	V0	TBD	V0	V0	V0	V0	TBD
<b>Curing requirements</b>												
Curing conditions			15°C to 40°C, 50% relative humidity	15°C to 40°C, 50% relative humidity	15°C to 40°C, 50% relative humidity	15°C to 40°C, 50% relative humidity	23°C, 50% RH	120°C	120°C	120°C	120°C	120°C
Handling time			1 hour	1 hour	1 hour	1 hour	10-25 minutes					
Cure time			24 hours	24 hours	24 hours	24 hours	12 hrs/mm thick	1 hour	1.5 hours	1 hours	1.5 hours	1 hour

(a) Test method ASTM D575

(b) Contact Laird Application Engineering for test data.

# MICROWAVE ABSORBERS

## PRODUCT SELECTION GUIDE

Frequency Range	Description	Thickness	Application
>10 GHz	Q Zorb™ - 2000	.020" (0.5 mm)	Q-Zorb is thinner and more robust for surface currents. Thicker is better for low frequency.
>8 GHz	Q Zorb™ - 2000	.040" (1.0 mm)	
>4 GHz	Q Zorb™ - 2000	.060" (1.5 mm)	
<4 GHz	Q Zorb™ - 2000	.125" (3.1 mm)	
<2 GHz	Q Zorb™ - 3000	.006" (0.15 mm)	
<2 GHz	Q Zorb™ - 3000	.020" (0.5 mm)	
Reflection Loss Broadband	RF Foam - 4000	.50" (12.5 mm)	Foam is lighter, cheaper, and thicker. Thicker is better at low frequency.
Insertion Loss Broadband	RF Foam - 5000	.125" (3.1 mm)	
Insertion Loss Broadband	RF Foam - 5000	.250" (6.25 mm)	

# DESIGN GUIDE FOR COMMERCIAL MICROWAVE ABSORBERS

Microwave absorbers have been used in military applications for several decades. They have been traditionally used for EMI reduction, antenna pattern shaping and radar cross reduction. More recently with the rise of wireless electronics and the movement to higher frequencies microwave absorbers or “noise suppression sheets” (NSS) are used to reduce electromagnetic interference (EMI) inside of the wireless electronics assemblies.

Two types of NSS are used for these types of applications. They are described below:

## MAGNETIC ABSORBERS

These are thin (.1 to 3 mm) polymeric materials filled with magnetic particles. These materials have both high permeability (magnetic loss properties) and high permittivity (dielectric loss properties). This combination of properties makes these materials very effective in eliminating high frequency EMI

Laird has two product types that are used for commercial applications:

- Q-Zorb HP (high permeability) uses novel magnetic fillers to achieve extremely high permeabilities at low frequencies. This allows for relatively thin materials to provide EMI reduction at frequencies below 2 GHz. This material comes in thicknesses of .15 mm and .5 mm.
- Q-Zorb HF (high frequency) is the optimum choice for cavity resonance problems from 2-18 GHz and higher. The material is available in thicknesses from .5 mm to 3.2 mm and is supplied in sheets or as die cut components. Both materials are UL-VO and ROHS compliant. They can be supplied with pressure sensitive adhesive (PSA) for ease of installation.

## FOAM ABSORBERS

These absorbers are based upon open celled foam impregnated with a carbon coating. The carbon coating makes the resultant product lossy at microwave frequencies, indeed acting like a free space resistor to incoming electromagnetic energy. These foam products range from 3.2 mm to 6.4 mm for internal cavity applications and can be several centimeters thick for outdoor applications. Two main product types are offered by Laird

- RFLS- Lossy sheets are uniformly loaded with the carbon coating and used at 3.2 mm and 6.4 mm thick. They are supplied as sheet materials and may have PSA applied and fire retardant coatings.
- RFRET- is a reticulated foam based absorber. The materials are thicker ranging from 3/8” to 2” in thickness. They can be used for air filtration and EMI, or on the inside of cabinet doors for broadband EMI attenuation.

## ABSORBER APPLICATIONS

Electronic operating at high frequencies can have problems with emission of high frequency noise. Once put inside an enclosure, the energy will add in phase at certain frequencies to cause resonances which will hinder the performance of the device. A good example of this phenomenon is seen in Figure 1. The amplifier was measured in the condition shown and subsequently remeasured inside of its enclosure. When put inside the enclosure the performance was severely degraded due to cavity resonances inside of the enclosure. The measured data is shown below in Figure 2.

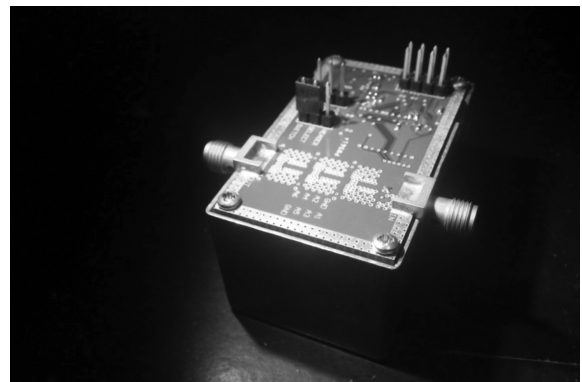

Figure 1. Variable Gain Broadband Amplifier 100 MHz to 12 GHz

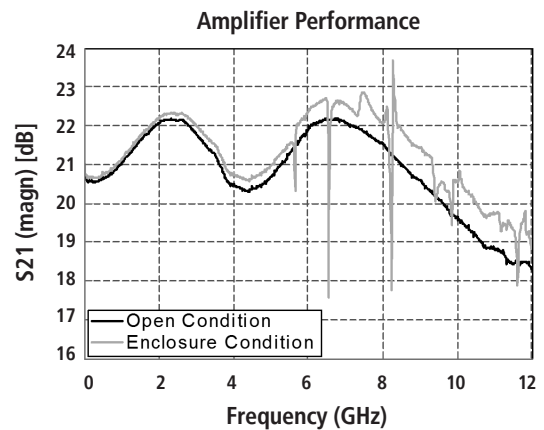

Figure 2. Performance of Amplifier in Open Condition and Inside Enclosure

# DESIGN GUIDE FOR COMMERCIAL MICROWAVE ABSORBERS

To improve the performance of the device, Laird Q-Zorb microwave absorber was put on the inside cover of the enclosure. This is a standard way in which absorbers are used. Q-Zorb is supplied with a pressure sensitive adhesive to allow for ease of installation. The cover is shown below in Figure 3.

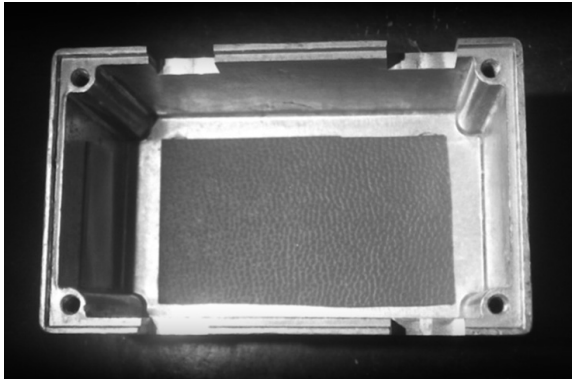

Figure 3. Enclosure with Q-Zorb PN 2238 Installed

The amplifier was then measured inside the enclosure with the Q-Zorb in place. The performance of the amplifier now mirrored the open condition by absorbing the internal reflections and surface currents. Figure 4 shows this measurement.

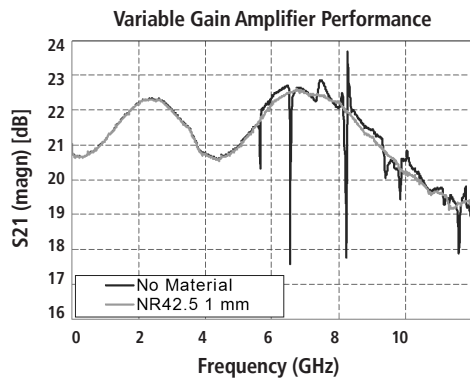

Figure 4. Performance of amplifier inside enclosure showing performance of Absorber Material (PN 2238)

## MAGNETIC ABSORBER VS. LOSSY FOAM

In these enclosure applications the designer needs to understand the tradeoffs between using the magnetic absorber vs the lossy foam type absorber. The foam absorber is a much more cost effective solution, provided it will meet the performance goals. However there are a couple major reasons to use the magnetic sheet absorbers (Q-Zorb)

- Foam absorbers can breakdown over time causing resistive particles to drop onto to circuit traces
- Energy along the side walls of cavity are H field (magnetic) dominated currents. The E field is at a minimum along the walls and materials with only dielectric loss (resistive foams) will not perform very well in these applications. The magnetic absorbers have high H field loss and attenuate these currents.

Figures 5 and 6 below do show the use of a lossy foam absorber inside of an amplifier cavity.

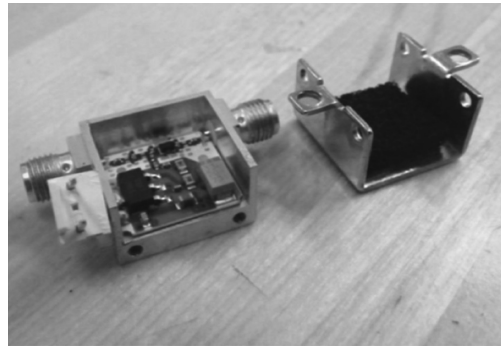

Figure 5. Amplifier and Enclosure with Lossy Foam Inside

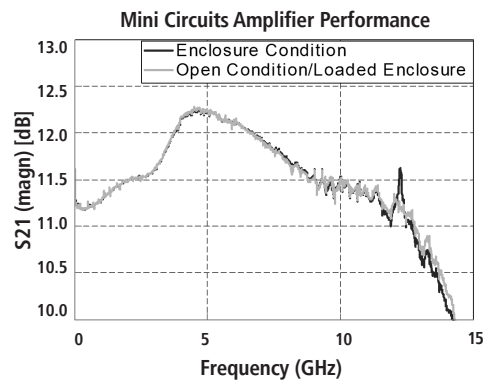

Figure 6. Performance in Enclosure and Using Foam Absorber

# DESIGN GUIDE FOR COMMERCIAL MICROWAVE ABSORBERS

## TUNED FREQUENCY VS SURFACE WAVE ABSORBERS

Laird offers two types of Q-Zorb materials: tuned frequency and surface wave absorbers. Tuned frequency materials are used in far field applications such as direct radar reflections off of an object. Surface wave absorbers are used for high angle of incidence applications and for cavity noise suppression. Many design engineers that have a cavity noise problem at a certain frequency want to use a tuned frequency absorber tuned to that frequency. However that is not the best performance they can achieve. Note that the tuned frequency materials offer good performance at normal angles of incidence, but perform more

poorly at higher angles of incidence. Inside the cavity noise generated is at a number of angles of incidence and also a significant of surface wave energy. The surface wave materials offer better performance in these applications. The curves below compare a tuned frequency absorber at normal incidence and at all angles of incidence. Note the improved bandwidth of the surface wave loading especially at higher angles of incidence. The Q-Zorb samples in the Laird Absorber sample kit are the surface wave absorber type. They are the best solution for solving cavity noise problems.

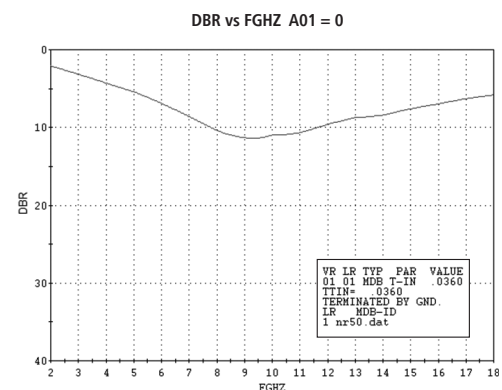
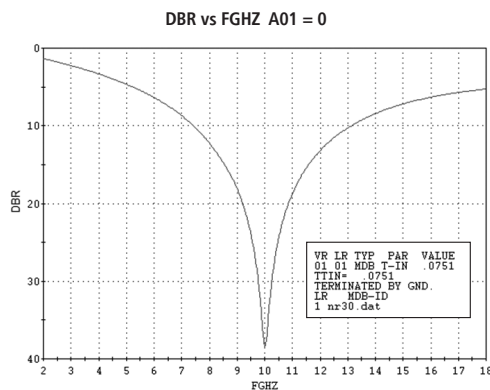

## EMI MODELING

Laird is a member of the EMC Consortium at Missouri Science and Technology School, Rolla Missouri. As part of this consortium Laird is modeling the use of absorbers for a variety of applications. The cavity application discussed above is one of the key areas of investigation. Other areas include directly placing absorbers on noisy chips, coating cables to reduce conducted EMI, and use on antennas. Laird is working on modeling these applications using 3D modeling software including HFSS, Microwave Studio, and EZ-FTDT. The Q-Zorb can be modeled as a Debye Oscillator and directly input into the codes. Laird can supply these models to customers for their own computer modeling. A few examples of this work are shown in the figures below.

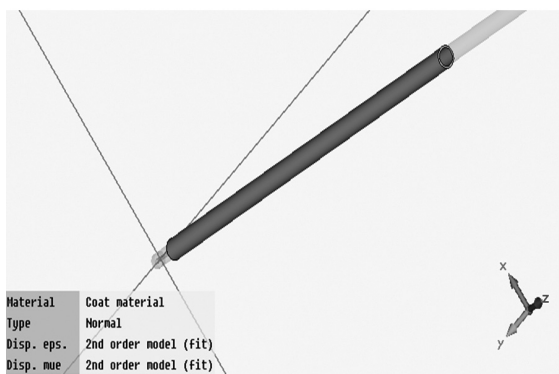

Figure 7. Microwave CST Model of Cable with Q-Zorb Coating

## SAMPLE KIT

To assist the microwave design engineer in the use of Laird absorbers, a sample kit containing the different types of microwave absorbers is offered. The kit contains all three types of materials including Q-Zorb HF, Q-Zorb HP, and RF Foam. A description of the sample kit is listed below.

The samples are 6" x 4" in size and can be easily cut into specific shaped pads. There are various thicknesses to evaluate. Generally speaking the thicker the sample the better it will work at low frequency. However if you are constrained by thickness, evaluate the one that will meet the thickness requirements and then test the electrical properties of the sample. To make even thicker test samples the samples can be bonded together. This will allow the designer to evaluate thickness vs performance.

PART NUMBER	DESCRIPTION	THICKNESS	FREQUENCY RANGE
2388	Q Zorb™ - RFSW	.020" (0.5 mm)	>10 GHz
2238	Q Zorb™ - RFSW	.040" (1.0 mm)	> 8 GHz
2240	Q Zorb™ - RFSW	.060" (1.5 mm)	> 4 GHz
2242	Q Zorb™ - RFSW	.125" (3.1 mm)	< 4 GHz
3535	CA-19	.006" (0.15 mm)	< 2 GHz
3536	CA-19	.020" (0.5 mm)	< 2 GHz
5206	RF Foam - RFLS	.125" (3.1 mm)	Insertion Loss Broadband
5092	RF Foam - RFLS	.250" (6.25 mm)	Insertion Loss Broadband
4106	RF Foam - RFRET	.50" (12.5 mm)	Insertion Loss Broadband

# Q-ZORB® 2000 HF (HIGH FREQUENCY) SURFACE WAVE ABSORBERS

Q-Zorb® 2000 HF surface wave absorbers are thin, magnetically loaded elastomeric sheets designed to provide attenuation at high angles of incidence for surface wave attenuation. They are nominally manufactured in the thickness range of 0.015" to 0.125" (0,4 mm to 3,2 mm). Q-Zorb® 2000 is silicone-based, meets the UL V0 fire retardant requirement and is RoHS compliant. Laird can provide the material die-cut and with a pressure-sensitive adhesive for ease of installations. Sheets are offered in nominal sizes of 24" x 24" (609,6 mm x 609,6 mm), although custom sizes and molded components are available.

## APPLICATIONS

The material can be used inside of microwave housings to reduce internal resonance and to lower the "Q" of the microwave cavity. They are also effective in isolating antennas from ground plane reflections. Q-Zorb® can be used with board-level shielding and other types of EMI shielding to enhance the shielding effectiveness at frequencies from 2-40 GHz.

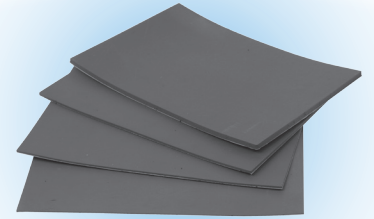

FIGURE 1.

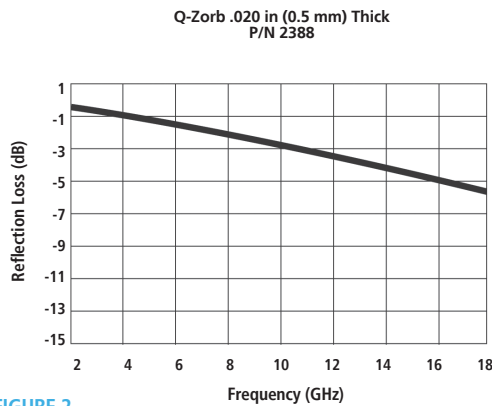

FIGURE 2.

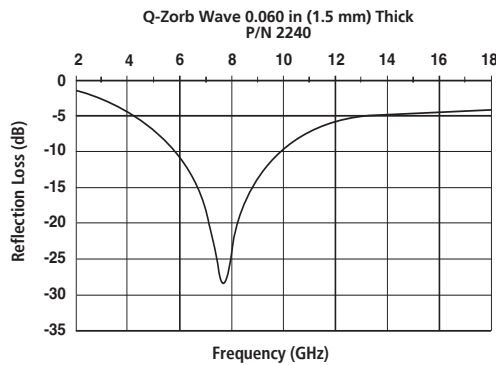

FIGURE 3.

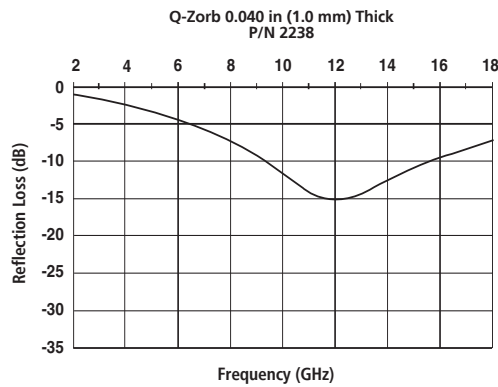
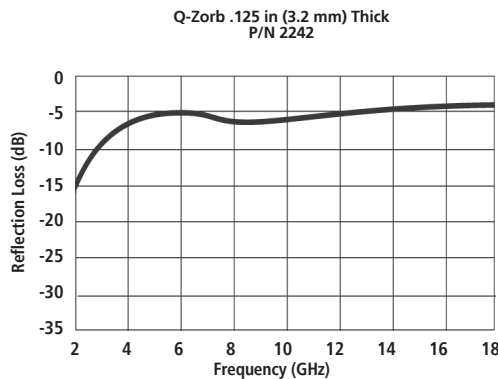

FIGURE 4.



PART NO.	SIZE	THICKNESS	WEIGHT	TEMPERATURE MAXIMUM	ELECTRICAL PERFORMANCE	COLOR	BONDING	FIRE RETARDANT RATING
2388	24" x 24"	0.20" nominal (.5 mm)	.50 lb/sq ft	300 °F	12-18 GHz	Gray	RoHS Compliant Sulfur-free	Supplied with 3M 9485 PSA
2388 -.25	12" x 12"							
2388 -S	4" x 6"							
2238	24" x 24"	.040" nominal (1 mm)	.94 lb/sq ft	300 °F	8-18 GHz	Gray	Good general weather and chemical resistance Sulfur-free	Supplied with 3M 9485 PSA
2238 -.25	12" x 12"							
2238 -S	4" x 6"							
2240	24" x 24"	0.60" nominal (1.5 mm)	1.2 lb/sq ft	300 °F	4-18 GHz	Gray	Good general weather and chemical resistance Sulfur-free	Supplied with 3M 9485 PSA
2240 -.25	12" x 12"							
2240 -S	4" x 6"							
2242	24" x 24"	.125" nominal (3.2 mm)	2.75 lb/sq ft	300 °F	1-18 GHz	Gray	Good general weather and chemical resistance Sulfur-free	Supplied with 3M 9485 PSA
2242 -.25	12" x 12"							
2242 -S	4" x 6"							

All dimensions shown are in inches (millimeters) unless otherwise specified.



# Q-ZORB® 3000 HP (HIGH PERMEABILITY) ABSORBERS CA-19

Q-Zorb 3000 HP product line utilizes special shaped magnetic fillers in a polymeric binder to produce thin sheets with excellent low frequency performance. The product has very high permeabilities along with low frequency magnetic loss. This allows relatively thin sheets of material to perform at frequencies below 2 GHz. CA 19 comes in thickness ranges of .006" .15 mm to .020" .5 mm. and is very flexible. The product is available in rolls 13" wide and any length available. It can be die cut into specific shapes and is supplied with a pressure sensitive adhesive backing for ease of use.

Two standard part numbers of Q-Zorb 3000 are available in the absorber sample kit. This allows the engineer to see if this product will help solve any specific EMI problem.

## APPLICATIONS

Q-Zorb 3000 is used in situations where low frequency (< 2 GHz) noise problems are occurring. Some applications include:

- Die cut components placed in microwave cavities
- Place on top of noisy chip to reduce emissions
- Wrapped around cables to reduce conducted emissions
- Used inside of board level shields to improve shielding performance

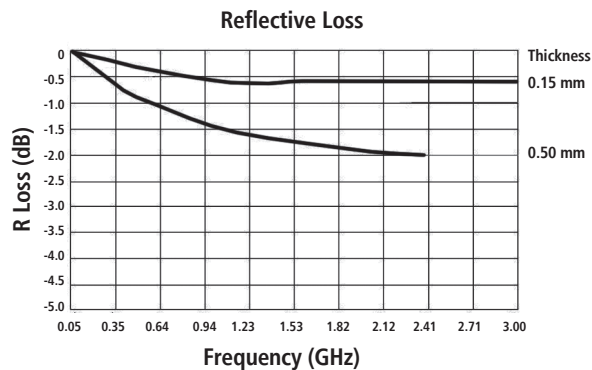

TYPICAL PHYSICAL PROPERTIES		
Size	3535	.006" x 12" x 13"
	3535-S	.006" x 4" x 6"
	3536	.020" x 12" x 13"
	3536-S	.020" x 4" x 6"
Permeability $\mu'$ (1 MHz)	37	
Electrical resistivity ( $\Omega / \square$ )	$6 \times 10^{10}$	
Specific gravity	3.1	
Tensile strength (MPa)	1.9	
Hardness (Durometer A)	70 $\pm$ 10%	
Thermal conductivity (W / mk)	1.0	
Flammability	UL94 V-0	

# RFRET 4000 RETICULATED FOAM ABSORBERS

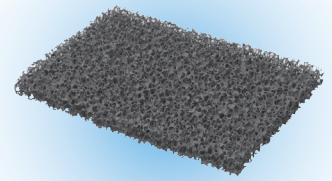

RFRET 4000 is a reticulated foam absorber. Reticulated foam is an urethane-based foam with a well-defined open-cell structure. The cell size can be chosen to optimize penetration of the conductive coating to which it is adhered. Laird uses two separate processes to produce its reticulated foam absorber. This unique spray process applies a coating that is graded through the thickness of the foam. The grading of the coating also produces an electrical grading that results in a material with excellent broadband reflectivity reduction.

## APPLICATIONS

RFRET broadband foam is commonly used around antennas to provide isolation or side lobe reduction. It can be die-cut into components for EMI reduction inside microwave cavities and is used to manufacture antenna hats and test boxes. It can be encapsulated into a textile cover for use outdoors and fabricated into blankets, covers and other components. Recently, it has been used for a combination air/EMI filter in networking equipment. The product can be made UL 94 HF1 for such applications.

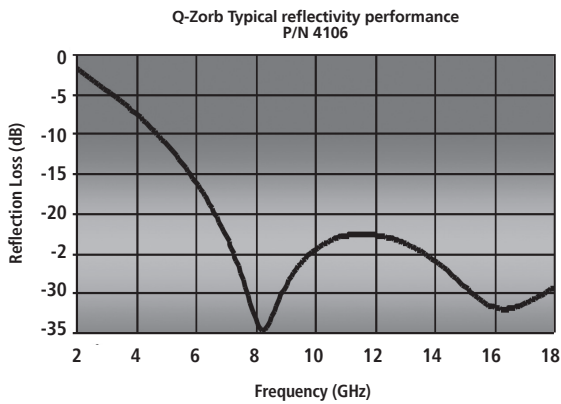

TYPICAL PHYSICAL PROPERTIES		
Size	4106	24" x 24"
	4106 -.25	12" x 12"
	4106 - S	4" x 6"
Thickness	0.50" nominal	
Weight	.092 lb/sq ft	
Temperature Maximum	250 °F	
Color	Gray	
Environmental	Withstands intermittent exposure to water without degradation	

# RFLS 5000 SINGLE LAYER "LOSSY" FOAM ABSORBERS

RFLS 5000 is a series of single layer "lossy" sheets produced by dipping lightweight open-celled urethane foam into a resistive solution. The end product is a uniform, lightweight, loaded sheet material with a specified insertion loss at a given frequency. RFLS offers the lowest cost in microwave absorber products. Thickness of the sheets range from 0.125" to 1.5" (3,2 mm to 38,1 mm) and are generally 24" x 24" (609,6 mm x 609,6 mm). Custom sizes and components can be fabricated. The insertion loss of the product is measured in an insertion tunnel over the 2 to 18 GHz frequency range. Specifications are generally given at 3 or 10 GHz. The material can be die-cut into components and supplied with a pressure-sensitive adhesive for ease of application.

## APPLICATIONS

RFLS sheets are used to lower noise or cavity Q's in microwave components such as amplifiers, oscillators, computer housings and wireless equipment.



Typical insertion loss performance

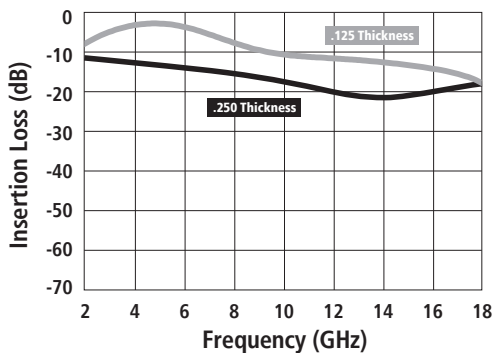

PART NO.	SIZE	THICKNESS	TEMPERATURE RANGE	COLOR	ENVIRONMENTAL	BONDING
5092	24" x 24"	0.25" nominal	-85 – 250° F	Black	RoHS Compliant	Supplied with 3M 9485 PSA
5092 -.25	12" x 12"					
5092 - S	4" x 6"					
5206	24" x 24"	0.125" nominal	-85 – 250° F	Black	RoHS Compliant	Supplied with 3M 9485 PSA
5206 -.25	12" x 12"					
5206 - S	4" x 6"					

## NOTES

The physical properties and electrical performance property above are typical for the material, but not intended for use in specifications or for the acceptance inspection criteria because of variations in testing methods, conditions and configurations.

# ANALYSIS, TEST AND PROTOTYPE DEVELOPMENT

## ABSORBER BOARD-LEVEL SHIELDING (ABLS)

Increasing use of printed circuit boards in complex electronics requires unique shielding solutions. Laird has developed a near field measurement to accurately determine the effectiveness of board-level shielding. Several Laird board-level shields have been characterized using this technique.

Laird has further enhanced performance at greater than 2 GHz by adding a microwave absorber to the board-level shield. Further work has been completed on Flomerics™ FLO-EMC to analytically investigate board-level shields performance improvement using absorbers at high frequency.

## THERMALLY CONDUCTIVE ABSORBERS – COOL-ZORB

Laird is developing thermally conductive microwave absorbing materials. These can be used as thermal pads between chips and heatsinks, allowing conduction of heat and dissipation of EMI. Initial testing and modeling has shown this to be an effective solution to heat sink radiation from noisy chips.

## MU EPSILON MEASUREMENT CAPABILITIES

Laird has a network analyzer to make amplitude and phase measurements from 130 MHz to 20 GHz. Laird also has a reflectivity arch, transmission tunnel and a variety of coaxial, wave-guide and other test equipment to determine intrinsic electrical properties of absorber materials. This ability has enabled Laird to build a database that customers can use to design new absorbers and analyze their performance in different situations.

## ANALYTICAL SOFTWARE VBROP

VBROP is a versatile Windows® 95/98/NT-based optimizer of multi-layered stacks for reflection or maximum transmission at specified frequencies, angle of incidence and polarization. The visual basic front-end makes the software extremely user friendly, with interactive analysis of layer properties versus performance. It is useful for the design, optimization and detailed performance analysis of RAM, RAS, radomes and microwave windows.

FIGURE 1.

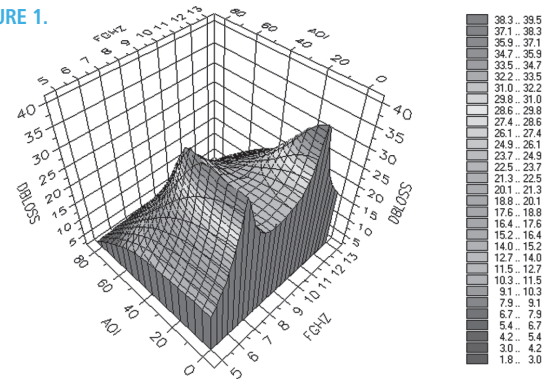

VBROP can optimize absorber performance at various frequencies and angles of incidence.

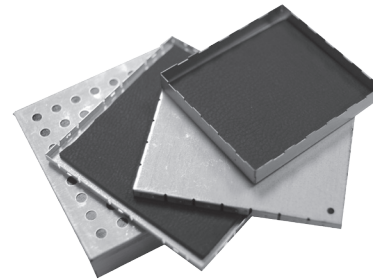

Absorber Board-level Shield (ABLS)

Americas: +1.800.634.2673  
Europe: +49.8031.24600  
ASEAN: +65.6243.8022  
China: +86.757.2563.8860  
India: +91.80.40740.400 x448  
Japan: +81.45.473.6808  
Korea: +82.10.8706.7469  
Taiwan: +886.2.22901234 x163

[www.lairdtech.com](http://www.lairdtech.com)



#### EMI-CAT-ESSENTIALS 1213

Any information furnished by Laird and its agents is believed to be accurate and reliable. All specifications are subject to change without notice. Responsibility for the use and application of Laird materials rests with the end user, since Laird and its agents cannot be aware of all potential uses. Laird makes no warranties as to the fitness, merchantability or suitability of any Laird materials or products for any specific or general uses. Laird, Laird Technologies, Inc or any of its affiliates or agents shall not be liable for incidental or consequential damages of any kind. All Laird products are sold pursuant to the Laird Technologies' Terms and Conditions of sale in effect from time to time, a copy of which will be furnished upon request. © Copyright 2013 Laird Technologies, Inc. All Rights Reserved. Laird, Laird Technologies, the Laird Technologies Logo, and other marks are trademarks or registered trademarks of Laird Technologies, Inc. or an affiliate company thereof. Other product or service names may be the property of third parties. Nothing herein provides a license under any Laird or any third party intellectual property rights.