

# Test Accessories for Extra-Low-Voltages

Test & Measureline | Test & Measurement

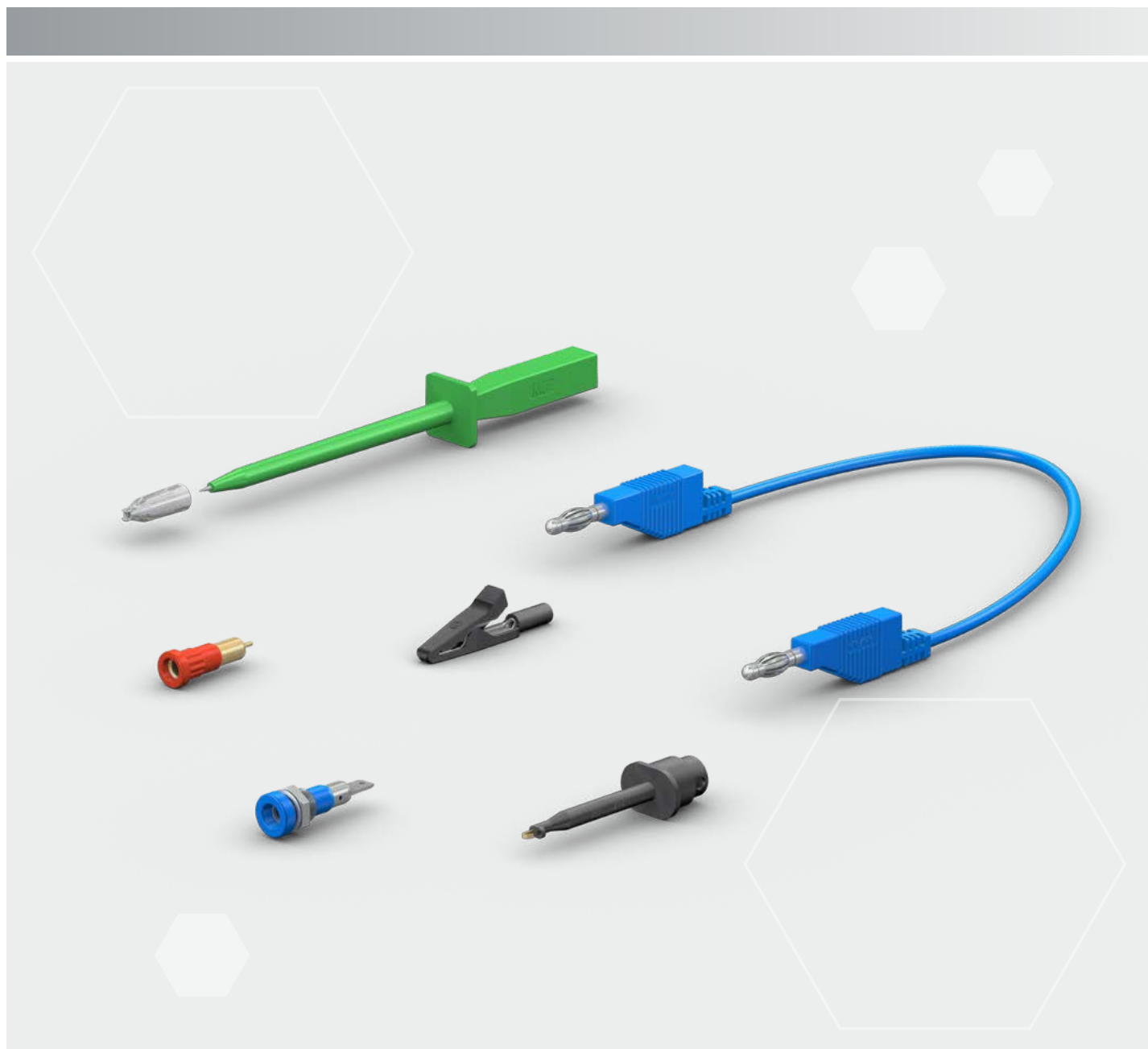

## STÄUBLI ELECTRICAL CONNECTORS

## Long-term solutions – Expert connections



**Stäubli Electrical Connectors is a leading international manufacturer of high-quality electrical connector systems. We are part of the Stäubli Group which offers mechatronics solutions for electrical connectors, liquid and gas couplings, robots and textile machinery.**

Stäubli develops, produces, sells and maintains products for markets with high productivity standards. As recognized specialists, our focus is always on solutions and customers. Many new developments got their start here and have begun to make their way around the world.

Businesses and customers count on our commitment and our active support when dealing with unusual problems. With us, you are entering into a long-term partnership built on reliability, dynamism, and exceptional quality in both products and services.

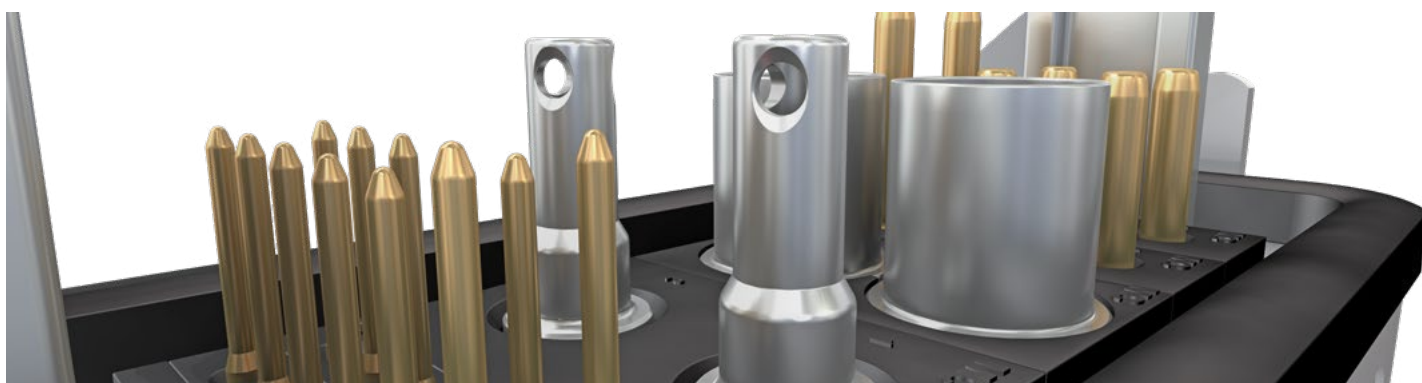

# Applications and advantages

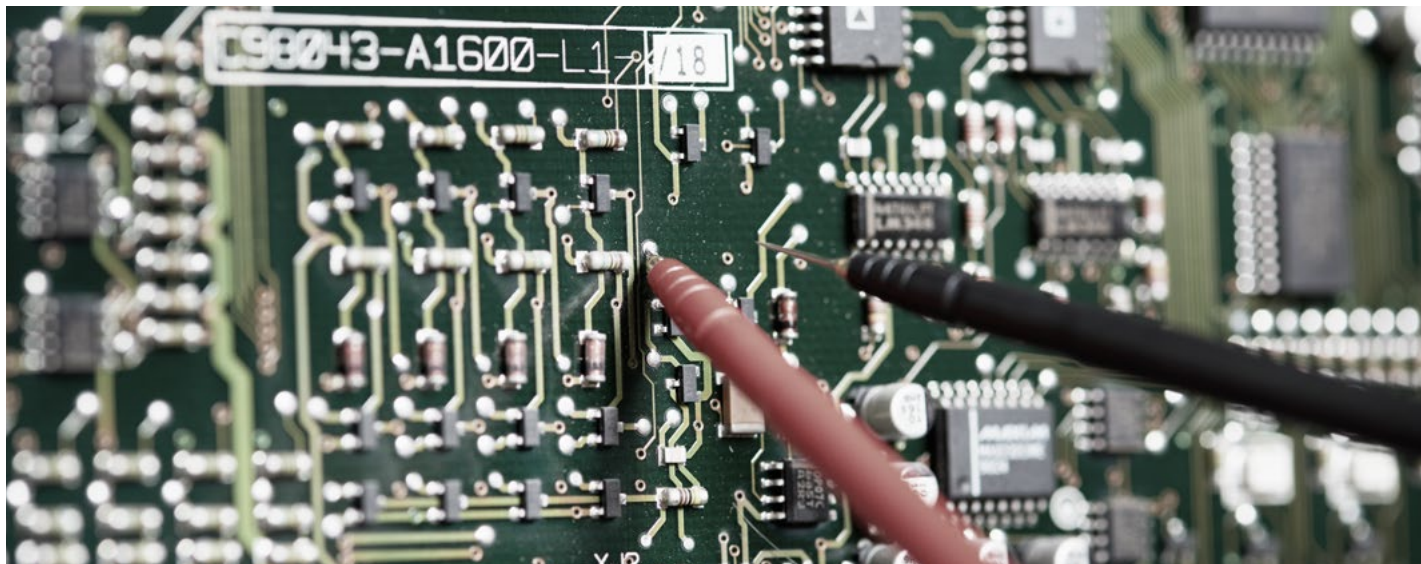

**In this voltage range up to 30 VAC / 60 VDC it is not considered dangerous to touch bare metal parts. However, people with pre-existing illnesses (in particular heart disease) should always avoid contact with electric potentials. For that reason, we recommend the use of touch-protected accessories only.**

If the low voltage is supplied by a mains adapter, a connection with the mains supply exists. In this case too, touch-protected test accessories should be used as a precautionary measure for the event of a fault in the mains adapter or possible surge voltages in the mains supply (lightning). Examples of applications for test accessories in the extra-low-voltage range include electronics laboratories and training estab-

lishments. The target group also includes electronics hobbyists who construct and experiment with battery-powered circuits. The MULTILAM contact technology, surface coating and the employed insulating materials conform to the same high standards as touch-protected Stäubli test accessories or our other product lines, and guarantee the accustomed high quality and long life of Stäubli products.

# Contents

<b>Page 6</b>	<b>General Information</b> <b>Portfolio overhaul</b> <b>Our Special-Area Catalogs</b> <b>Measurement Categories</b>	<b>Page 68</b>	<b>Assembly Material and Accessories</b> <ul style="list-style-type: none"><li>▪ Hexagonal Nuts</li><li>▪ Round Nuts</li><li>▪ Washers</li><li>▪ Spring Washers</li><li>▪ Protective Caps</li><li>▪ Safety Hood</li><li>▪ Spacer Sleeves</li><li>▪ Flat Connecting Receptacles</li><li>▪ Tube Spanners</li><li>▪ Hexagonal Wrenches</li><li>▪ Press-in Tools</li><li>▪ Insulation Stripping Pincers</li><li>▪ Crimping Pliers</li><li>▪ Test Lead Holders</li></ul>
<b>Page 9</b>	<b>Ø 1 mm system</b> <ul style="list-style-type: none"><li>▪ Ø 1 mm Test Leads</li><li>▪ Miniature Plugs and Sockets</li><li>▪ Miniature Test Clip</li></ul>	<b>Page 77</b>	<b>Appendix</b> <ul style="list-style-type: none"><li>▪ Product range consolidation/Alternative article</li><li>▪ Index</li></ul>
<b>Page 14</b>	<b>Ø 2 mm system</b> <ul style="list-style-type: none"><li>▪ Ø 2 mm Test Leads</li><li>▪ Ø 2 mm Plugs and Sockets</li><li>▪ Ø 2 mm Test Probes and Clips</li><li>▪ Ø 2 mm Connecting Plugs</li><li>▪ Ø 2 mm / Ø 4 mm Adapter and Adapter Leads</li></ul>		
<b>Page 34</b>	<b>Ø 4 mm system</b> <ul style="list-style-type: none"><li>▪ Ø 4 mm Test Leads</li><li>▪ Ø 4 mm plugs and sockets</li><li>▪ Ø 4 mm Test Probes and Clips</li><li>▪ Ø 4 mm Connecting Plugs</li><li>▪ Ø 4 mm Adapters</li></ul>		

UNLIMITED POSSIBILITIES FOR CONTACT SOLUTIONS

MULTILAM Technology

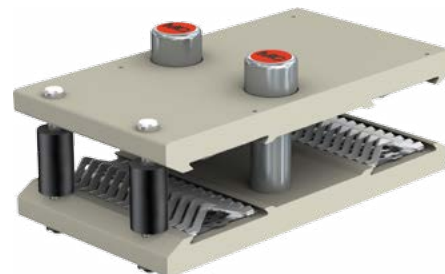

**MULTILAM** are specially formed and resilient contact elements. All Stäubli Electrical Connectors products benefit from the unique and outstanding performance of the **MULTILAM Technology**.

Thanks to their constant spring pressure, MULTILAM louvers ensure continuous contact with the contact surface, resulting in a constantly low contact resistance.

MULTILAM Technology allows to find solutions for connectors within the severest constraints and in certain products for up to 1 million mating cycles.

This makes the MULTILAM Technology the best choice for applications with demanding requirements:

- Reliable and longlife operation due to constantly high performance
- Safe operation under highest environmental demands on temperature, vibration and shock
- Suitable for data and signal contacts as well as high-current connectors
- Automated solutions with a high number of mating cycles



# General Information

## Length and color code

For items that are available in more than one color or lead length, write the desired lengths and color codes after the order number instead of the spaces □ and \* used in the catalog.

20	green-yellow	26	violet
21	black	27	brown
22	red	28	grey
23	blue	29	white
24	yellow	33	transparent
25	green		

## Lead length

The lead length of all standard leads in this catalog refers to the visible length of the cable.

## Standard items/special items

The length and color combinations listed in the catalog are available as standard items. Other length and/or color combinations that are not listed in the catalog are available on request. We are happy to provide you with more information regarding the price, delivery times and, where applicable, minimum order quantities for our special items on request.

## Changes/provisos

All data, illustrations, and drawings in the catalog have been carefully checked. They are in accordance with our experience to date, but no responsibility can be accepted for errors. We also reserve the right to make modifications for design and safety reasons. When designing equipment incorporating our components, it is therefore advisable not to rely solely on the data in the catalog but to consult us to make sure this information is up to date. We shall be pleased to advise you.

## Copyright

The use of this catalog for any other purpose, in whatever form, without our prior written consent is not permitted.

## RoHS ready

Directive 2011/65/EC on the restriction of the use of certain hazardous substances in electrical and electronic equipment.

## Surfaces

Au	Gold-plated
Ni	Nickel-plated
Ag	Silver-plated
Sn	Tin-plated
Zn	Zinc-plated
PVC	PVC
SIL	Silicone
TPE	TPE
Opt	Optalloy® finish

Optalloy® is a registered trade mark of Collini-Flühmann AG.

## Symbols



**Accessories or special tools exist for this product.**



**Before use, please read the enclosed rating sheet RZ000.**



**The assembly instruction MA000 is available for this product.**

# Portfolio overhaul

Stäubli has to carry out an overhaul of its portfolio. If you cannot find the items you are looking for in this catalog, please refer to pages 77 - 82, where you

will find a comprehensive list of all items affected by this overhaul. Where applicable, an alternative is listed next to the affected item.

In case of any questions please contact our field sales team.

# Our special-area catalogues

To provide the various target groups with a presentation of the accessories adapted to their specific needs, we have divided the

range into a number of specialized catalogs in line with the measurement categories of IEC/EN 61010-031.

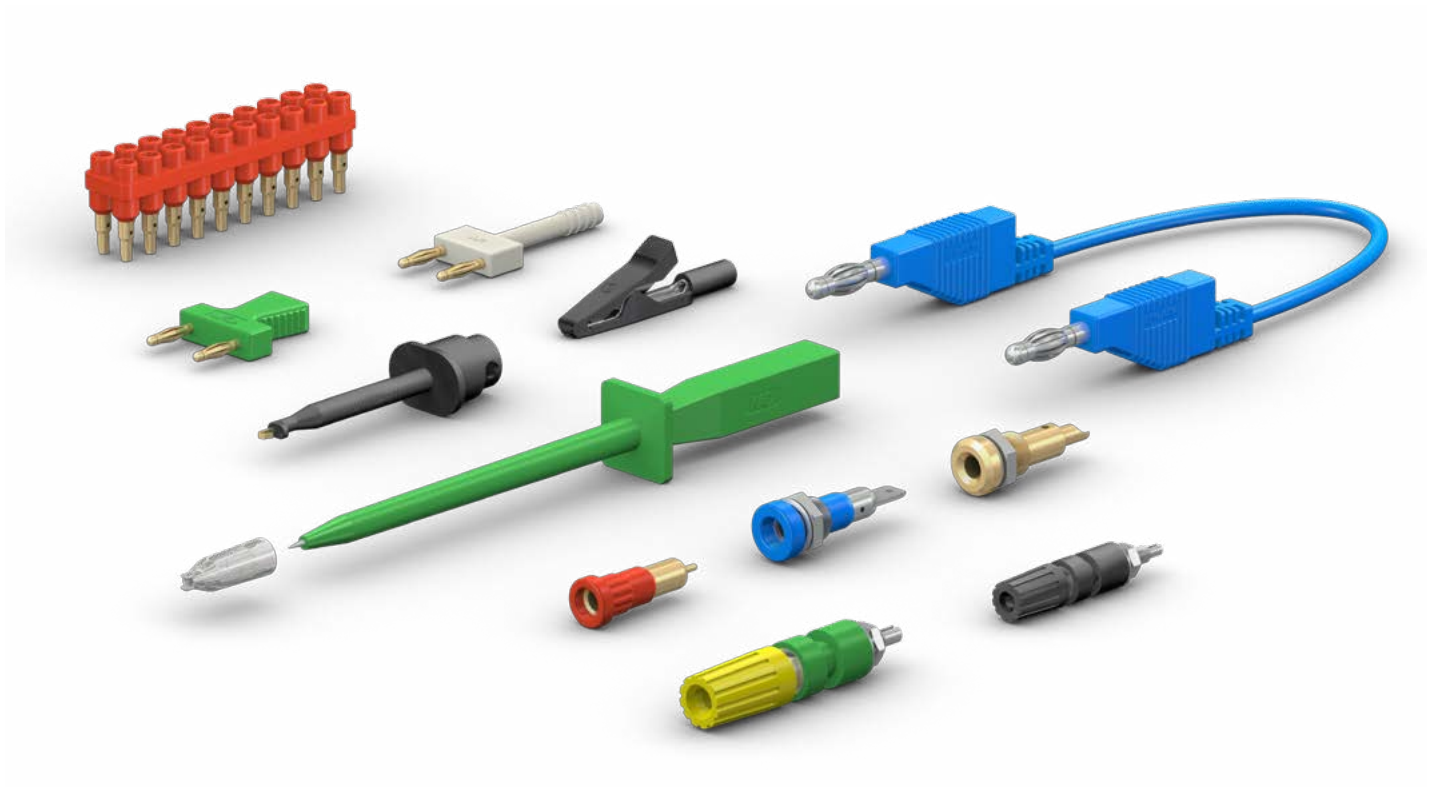

# Measurement Categories according to IEC/EN 61010-031:2008

To facilitate the assignment of test accessories to the appropriate applications, standard IEC/EN 61010-031 has established a number of categories which define where they can be used in the power supply network and to lay down appropriate requirements for each category.

Formerly (until 2002), the measurement categories now defined in standard IEC/EN 61010-031 were designated as overvoltage categories. This term originated from the

fact that the classification was based primarily upon the overvoltages (surges) that were likely to occur in the power grid.

Actually the measurement categories differ not so much in the level of the expected transient values as with regard to the available energy in each test category in the event of a short circuit.

In a higher measurement category more energy can be released than in a lower one, with results that may even have an explo-

sive like character with very serious consequences for the user.

In standard EN 61010-031 there are different test categories, abbreviated "CAT". The category CAT followed by a number from I to IV is stated in our catalogs with the rated voltage, and also marked on the products.

As a general rule, the higher the CAT rating, the higher the safety requirement that applies to the product.

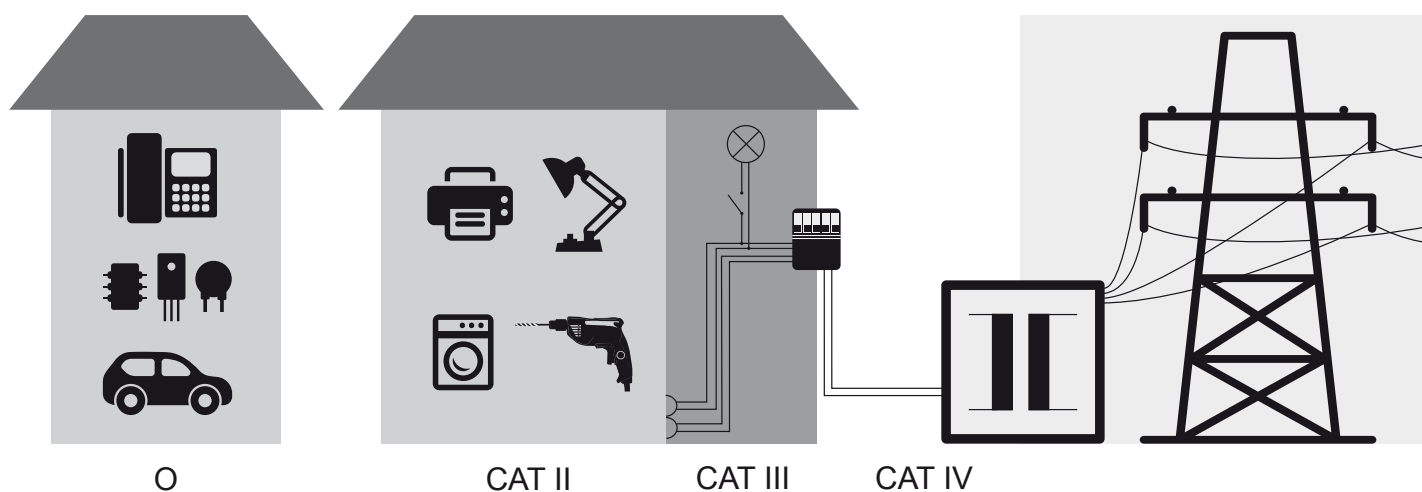

**O** Other circuits that are not directly connected to mains.

**CAT II** applies to measurements on equipment that is connected to the grid or supplied from the grid without constituting a part of the grid installation.

**CAT III** applies to measurements inside the house or building installation.

**CAT IV** applies to measurements at the supply source of the installation (input side).



Ø 1 MM SYSTEM

Ø 1 mm Test Leads

Test Lead LK1-A

Highly flexible, with stackable Ø 1 mm rigid plugs on both ends.

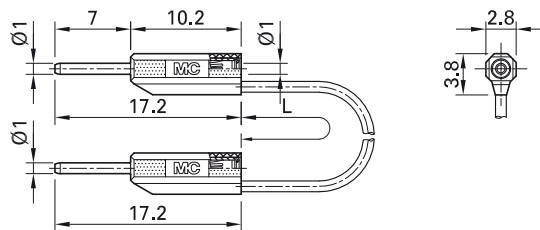
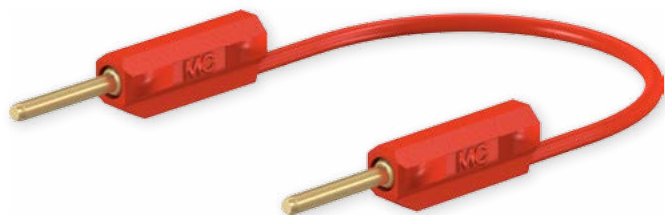

Order No.	Type	Rated voltage/current	Lead		Lead lengths L [cm]	*Colors
28.0026-□*	LK1-A	30 VAC / 3 A 60 VDC / 3 A	PVC 0.127 mm <sup>2</sup>	Au	007 (7.5 cm) 015 030 045	21 22 23 24 25

Test Lead LK1-S

Highly flexible, with in-line Ø 1 mm rigid plugs on both ends.

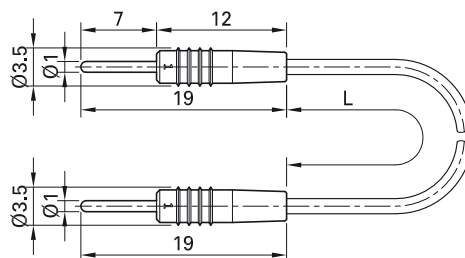
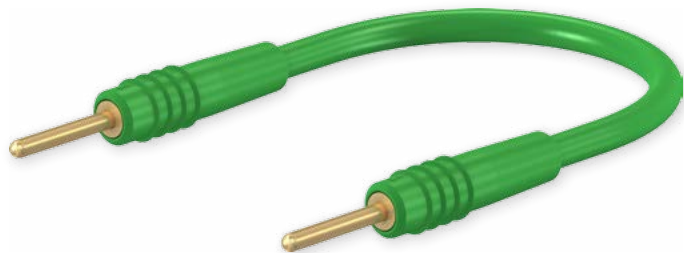

Order No.	Type	Rated voltage/current	Lead		Lead lengths L [cm]	*Colors
28.0028-□*	LK1-S	30 VAC / 6 A 60 VDC / 6 A	PVC 0.25 mm <sup>2</sup>	Au	007 (7.5 cm) 015 030 045	21 22 23 24 25 26

# Miniature Plugs and Sockets

## Plug SLS0,76-S

Ø 0.76 mm rigid for self-assembly of test leads.

**Crimp connection.**

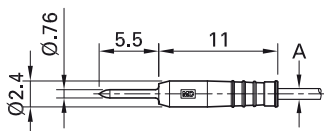

Order No.	Type	Rated voltage/current	Cable (A)		*Colors
22.2600-*	SLS0,76-S	30 VAC / 4 A 60 VDC / 4 A	max. Ø 1.4 mm 0.17 mm <sup>2</sup>	Au	21 22

### Component parts

22.2210-*	KT0,76-S	Insulator
22.1017	LS0,76-S	Plug



Assembly instructions MA143

[www.staubli.com/electrical](http://www.staubli.com/electrical)

## Plug SLS1-S

Ø 1 mm rigid for self-assembly of test leads.

**Solder connection.**

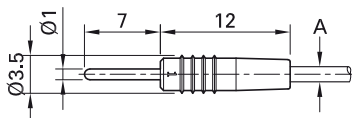

Order No.	Type	Rated voltage/current	Cable (A)		*Colors
22.2602-*	SLS1-S	30 VAC / 6 A 60 VDC / 6 A	max. Ø 1.7 mm 0.25 mm <sup>2</sup>	Au	21 22 23 24 25 26 27 28 29

### Component parts

22.2070-*	KT1-S	Insulator
22.1007	LS1-S	Plug



Assembly instructions MA144

[www.staubli.com/electrical](http://www.staubli.com/electrical)

## Socket SLS1-B

Ø 1 mm with spring-loaded MULTILAM for self-assembly of test leads.

**Solder connection.**

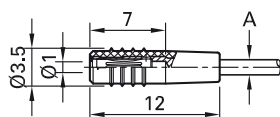

**Assembly instructions MA145**

[www.staubli.com/electrical](http://www.staubli.com/electrical)

Order No.	Type	Rated voltage/current	Cable (A)		*Colors												
22.2603-*	SLS1-B	30 VAC / 6 A 60 VDC / 6 A	max. Ø 1.7 mm	0.25 mm <sup>2</sup>	<table border="1"> <tr> <td>Au</td> <td>21</td> <td>22</td> <td>23</td> <td>24</td> <td>25</td> </tr> <tr> <td></td> <td>26</td> <td>27</td> <td>28</td> <td>29</td> <td></td> </tr> </table>	Au	21	22	23	24	25		26	27	28	29	
Au	21	22	23	24	25												
	26	27	28	29													

### Component parts

22.2070-*	KT1-S	Insulator
22.1008	LS1-B	Socket

## Socket SLS1,25-B

Ø 1.25 mm with spring-loaded MULTILAM for self-assembly of test leads.

**Solder connection.**

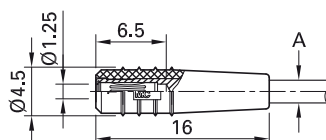

Order No.	Type	Rated voltage/current	Cable (A)		*Colors												
22.2605-*	SLS1,25-B	30 VAC / 6 A 60 VDC / 6 A	max. Ø 2.1 mm	0.5 mm <sup>2</sup>	<table border="1"> <tr> <td>Au</td> <td>21</td> <td>22</td> <td>23</td> <td>24</td> <td>25</td> </tr> <tr> <td></td> <td>26</td> <td>27</td> <td>28</td> <td>29</td> <td></td> </tr> </table>	Au	21	22	23	24	25		26	27	28	29	
Au	21	22	23	24	25												
	26	27	28	29													

### Component parts

22.2010-*	KT2-S	Insulator
22.1044	LS1,25-B	Socket



**Assembly instructions MA145**

[www.staubli.com/electrical](http://www.staubli.com/electrical)

## Plug SLS1,5-S

Ø 1.5 mm rigid for self-assembly of test leads.

**Solder connection.**

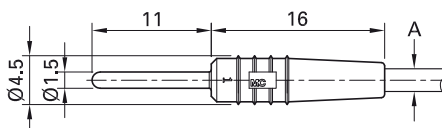
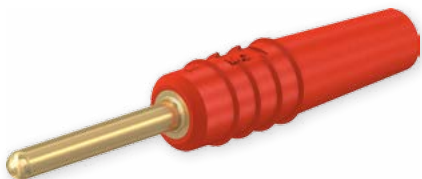

Assembly instructions MA132

[www.staubli.com/electrical](http://www.staubli.com/electrical)

Order No.	Type	Rated voltage/current	Cable (A)		*Colors										
22.2606-*	SLS1,5-S	30 VAC / 10 A 60 VDC / 10 A	max. Ø 2.1 mm 0.5 mm <sup>2</sup>	Au	<table border="1"> <tr> <td>21</td> <td>22</td> <td>23</td> <td>24</td> <td>25</td> </tr> <tr> <td>26</td> <td>27</td> <td>28</td> <td>29</td> <td></td> </tr> </table>	21	22	23	24	25	26	27	28	29	
21	22	23	24	25											
26	27	28	29												

### Component parts

22.2010-*	KT2-S	Insulator
22.5101	LS1,5-S	Plug

## Press-in Socket EB...

Insulated, Ø 0.76 mm and Ø 1 mm, spring-loaded with MULTILAM. Brass. The socket is pressed into predrilled panels.

**Solder connection.**

EB0,76



EB1

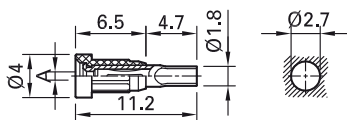

Assembly instructions MA102

[www.staubli.com/electrical](http://www.staubli.com/electrical)

Order No.	Type	Rated voltage/current	Socket diameter (A)		*Colors										
23.1009-*	EB0,76	30 VAC / 15 A 60 VDC / 15 A	Ø 0.76 mm	Au	<table border="1"> <tr> <td>20</td> <td>21</td> <td>22</td> <td>23</td> <td>24</td> </tr> <tr> <td>25</td> <td>26</td> <td>27</td> <td>28</td> <td>29</td> </tr> </table>	20	21	22	23	24	25	26	27	28	29
20	21	22	23	24											
25	26	27	28	29											
23.1010-*	EB1	30 VAC / 20 A 60 VDC / 20 A	Ø 1.0 mm	Au	<table border="1"> <tr> <td>20</td> <td>21</td> <td>22</td> <td>23</td> <td>24</td> </tr> <tr> <td>25</td> <td>26</td> <td>27</td> <td>28</td> <td>29</td> </tr> </table>	20	21	22	23	24	25	26	27	28	29
20	21	22	23	24											
25	26	27	28	29											

### Component parts

23.5000-*	I-EB1	Insulator
41.0009	LB0,76	Socket for EB0,76
41.0010	LB1	Socket for EB1



Press-in tool MB1, page 73

# Miniature Test Clip

## Test Clip KPS1

Made of hard-drawn copper alloy for grasping IC legs, plug pins and bare wire connections. Grasped objects are pressed against the tip of the insulator under spring pres-

sure. The low weight of the clip imposes hardly any load even on critical contacts. Solder connection for wires.

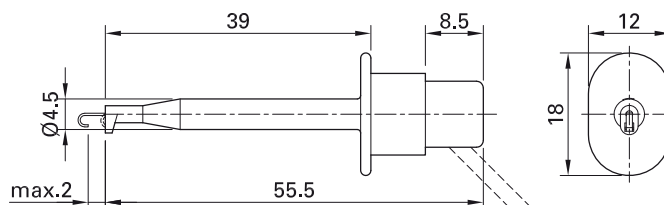
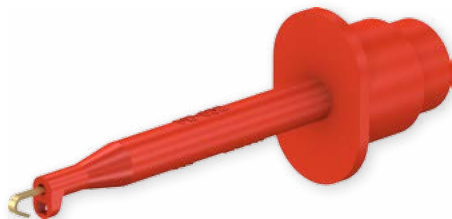

Order No.	Type	Rated voltage/current	Clamping limit		*Colors
24.0135-*	KPS1	30 VAC / 1 A 60 VDC / 1 A	max. 2 mm	Au	21 22

Ø 2 MM SYSTEM

Ø 2 mm Test Leads

Test Lead LK2-F

Highly flexible with stackable Ø 2 mm hollow plugs on both ends.

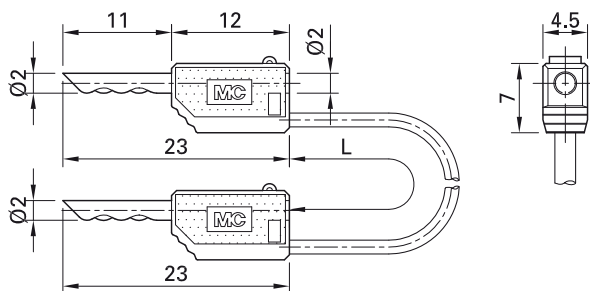
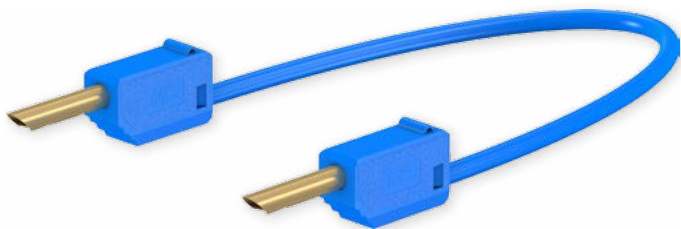

Order No.	Type	Rated voltage/current	Lead		Lead lengths L [cm]	*Colors
28.0033-□*	LK2-F	30 VAC / 10 A 60 VDC / 10 A	PVC 0.5 mm <sup>2</sup>	Au	007 (7.5 cm) 015 030 045 060	21 22 23 24 25

Test Lead LK205...

Highly flexible with stackable Ø 2 mm MULTILAM plugs on both ends.

LK205

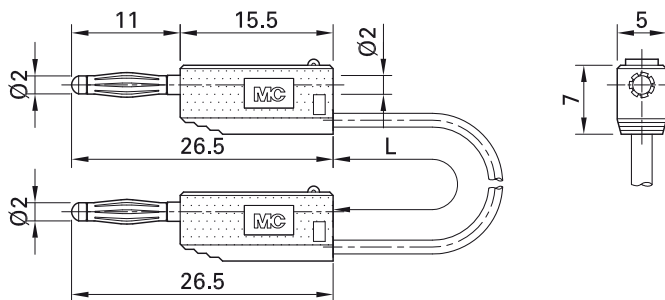
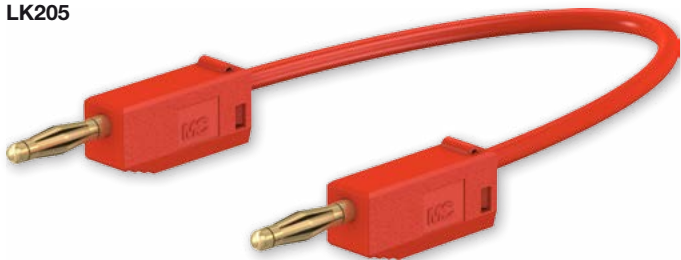

Order No.	Type	Rated voltage/current	Lead		Lead lengths L [cm]	*Colors
28.0115-□*	LK205-X	30 VAC / 10 A 60 VDC / 10 A	PVC 0.5 mm <sup>2</sup>	Ni	007 (7.5 cm) 015 030 045 060	21 22 23 24 25
28.0039-□*	LK205	30 VAC / 10 A 60 VDC / 10 A	PVC 0.5 mm <sup>2</sup>	Au	007 (7.5 cm) 015 030 045 060	21 22 23 24 25 27 28 29

## Test Lead LK205-L

Highly flexible with in-line Ø 2 mm  
MULTILAM plugs on both ends.

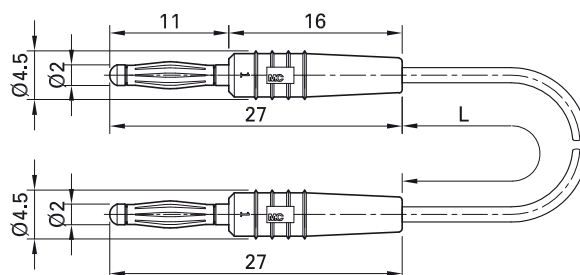

Order No.	Type	Rated voltage/current	Lead		Lead lengths L [cm]	*Colors
28.0047-□*	LK205-L	30 VAC / 10 A 60 VDC / 10 A	PVC 0.5 mm <sup>2</sup>	Au	007 (7.5 cm) 015 030 045 060	21 22 23 24 25 26 28

# Ø 2 mm Plugs and Sockets

## Plug SLS2-F

Stackable, Ø 2 mm hollow plugs for self-assembly of test leads.

**Solder connection.**

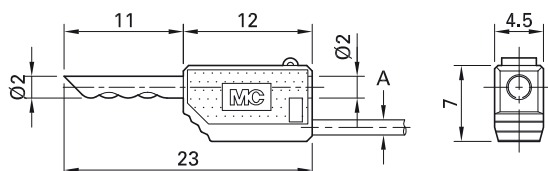
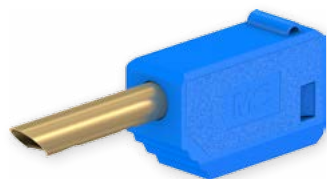

Assembly instructions MA133

[www.staubli.com/electrical](http://www.staubli.com/electrical)

Order No.	Type	Rated voltage/current	Cable (A)	*Colors																			
22.2611-*	SLS2-F	30 VAC / 10 A 60 VDC / 10 A	<table border="0"> <tr> <td>PVC</td> <td>TPE</td> <td>Ø 2.1 mm</td> <td rowspan="2">0.5 mm<sup>2</sup></td> </tr> <tr> <td>SIL</td> <td></td> <td>Ø 2.3 mm</td> </tr> </table>	PVC	TPE	Ø 2.1 mm	0.5 mm <sup>2</sup>	SIL		Ø 2.3 mm	<table border="0"> <tr> <td>Au</td> <td>21</td> <td>22</td> <td>23</td> <td>24</td> <td>25</td> </tr> <tr> <td></td> <td>27</td> <td>29</td> <td></td> <td></td> <td></td> </tr> </table>	Au	21	22	23	24	25		27	29			
PVC	TPE	Ø 2.1 mm	0.5 mm <sup>2</sup>																				
SIL		Ø 2.3 mm																					
Au	21	22	23	24	25																		
	27	29																					

### Component parts

22.2020-*	KT2-F	Insulator
22.1006	LS2-F	Plug

## Plug SLS205-A

Stackable, Ø 2 mm with spring-loaded MULTILAM for self-assembly of test leads.

**Solder connection.**

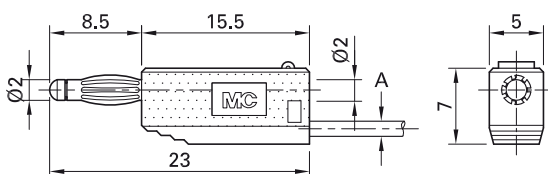

Order No.	Type	Rated voltage/current	Cable (A)	*Colors																			
22.2615-*	SLS205-A	30 VAC / 10 A 60 VDC / 10 A	<table border="0"> <tr> <td>PVC</td> <td>TPE</td> <td>Ø 2.1 mm</td> <td rowspan="2">0.5 mm<sup>2</sup></td> </tr> <tr> <td>SIL</td> <td></td> <td>Ø 2.3 mm</td> </tr> </table>	PVC	TPE	Ø 2.1 mm	0.5 mm <sup>2</sup>	SIL		Ø 2.3 mm	<table border="0"> <tr> <td>Au</td> <td>20</td> <td>21</td> <td>22</td> <td>23</td> <td>24</td> </tr> <tr> <td></td> <td>25</td> <td>26</td> <td>27</td> <td>28</td> <td>29</td> </tr> </table>	Au	20	21	22	23	24		25	26	27	28	29
PVC	TPE	Ø 2.1 mm	0.5 mm <sup>2</sup>																				
SIL		Ø 2.3 mm																					
Au	20	21	22	23	24																		
	25	26	27	28	29																		

### Component parts

22.2030-*	KT205	Insulator
22.5014	LS205-A	Plug



Assembly instructions MA135

[www.staubli.com/electrical](http://www.staubli.com/electrical)



## Plug SLS205...

Stackable, Ø 2 mm with spring-loaded MULTILAM for self-assembly of test leads.

**Solder connection.**

SLS205

SLS205-X

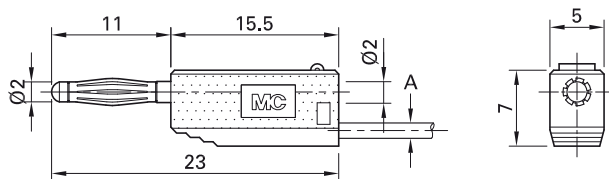
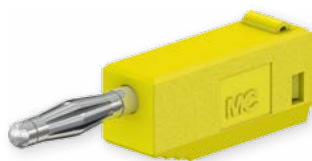
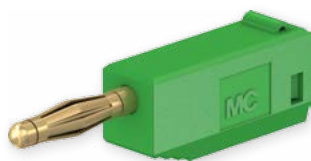

Order No.	Type	Rated voltage/current	Cable (A)		*Colors																	
22.2616-*	SLS205	30 VAC / 10 A 60 VDC / 10 A	<table border="1"> <tr> <td>PVC</td> <td>TPE</td> <td>Ø 2.1 mm</td> <td rowspan="2">0.5 mm<sup>2</sup></td> </tr> <tr> <td>SIL</td> <td></td> <td>Ø 2.3 mm</td> </tr> </table>	PVC	TPE	Ø 2.1 mm	0.5 mm <sup>2</sup>	SIL		Ø 2.3 mm	Au	<table border="1"> <tr> <td>20</td><td>21</td><td>22</td><td>23</td><td>24</td> </tr> <tr> <td>25</td><td>26</td><td>27</td><td>28</td><td>29</td> </tr> </table>	20	21	22	23	24	25	26	27	28	29
PVC	TPE	Ø 2.1 mm	0.5 mm <sup>2</sup>																			
SIL		Ø 2.3 mm																				
20	21	22	23	24																		
25	26	27	28	29																		
22.2617-*	SLS205-X	30 VAC / 10 A 60 VDC / 10 A	<table border="1"> <tr> <td>PVC</td> <td>TPE</td> <td>Ø 2.1 mm</td> <td rowspan="2">0.5 mm<sup>2</sup></td> </tr> <tr> <td>SIL</td> <td></td> <td>Ø 2.3 mm</td> </tr> </table>	PVC	TPE	Ø 2.1 mm	0.5 mm <sup>2</sup>	SIL		Ø 2.3 mm	Ni	<table border="1"> <tr> <td>21</td><td>22</td><td>23</td><td>24</td><td>25</td> </tr> <tr> <td>26</td><td>27</td><td>28</td><td>29</td><td></td> </tr> </table>	21	22	23	24	25	26	27	28	29	
PVC	TPE	Ø 2.1 mm	0.5 mm <sup>2</sup>																			
SIL		Ø 2.3 mm																				
21	22	23	24	25																		
26	27	28	29																			

### Component parts

22.2030-*	KT205	Insulator
22.1004	LS205	Plug for SLS205
22.5006	LS205N	Plug for SLS205-X



Assembly instructions MA134

[www.staubli.com/electrical](http://www.staubli.com/electrical)

## Plug SLS2-S

In-line, rigid, Ø 2 mm for self-assembly of test leads.

**Solder connection.**

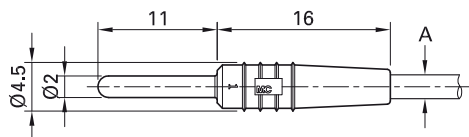

Assembly instructions MA132

[www.staubli.com/electrical](http://www.staubli.com/electrical)

Order No.	Type	Rated voltage/current	Cable (A)		*Colors										
22.2609-*	SLS2-S	30 VAC / 10 A 60 VDC / 10 A	max. Ø 2.1 mm 0.5 mm <sup>2</sup>	Au	<table border="1"> <tr> <td>21</td><td>22</td><td>23</td><td>24</td><td>25</td> </tr> <tr> <td>26</td><td>27</td><td>28</td><td>29</td><td></td> </tr> </table>	21	22	23	24	25	26	27	28	29	
21	22	23	24	25											
26	27	28	29												

### Component parts

22.2010-*	KT2-S	Insulator
22.1002	LS2-S	Plug

## Plug SLS205-U

In-line, rigid, Ø 2 mm for self-assembly of test leads. Soft insulator.

**Solder connection.**

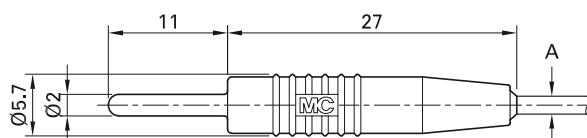

Order No.	Type	Rated voltage/current	Cable (A)		*Colors
22.2608-*	SLS205-U	30 VAC / 10 A 60 VDC / 10 A	max. Ø 2.3 mm 0.5 mm <sup>2</sup>	Au	21 22 23

### Component parts

22.2360-*	KT205-S	Insulator
22.1041	LS205-U	Plug



Assembly instructions MA137

[www.staubli.com/electrical](http://www.staubli.com/electrical)

## Plug SLS205-S

In-line, Ø 2 mm with spring-loaded MULTILAM for self-assembly of test leads. Soft insulator.

**Solder connection.**

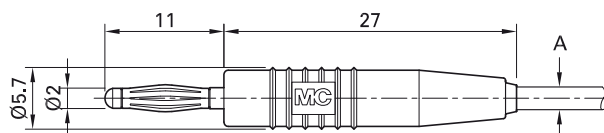

Order No.	Type	Rated voltage/current	Cable (A)		*Colors
22.2620-*	SLS205-S	30 VAC / 10 A 60 VDC / 10 A	max. Ø 2.3 mm 0.5 mm <sup>2</sup>	Au	21 22 23

### Component parts

22.2360-*	KT205-S	Insulator
22.1040	LS205-S	Plug



Assembly instructions MA137

[www.staubli.com/electrical](http://www.staubli.com/electrical)

## Plug SLS205-L...

In-line, Ø 2 mm with spring-loaded MULTILAM for self-assembly of test leads.

**Solder connection.**

SLS205-L

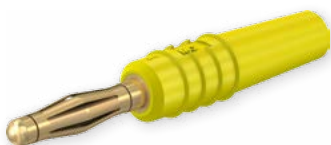

SLS205-L/N

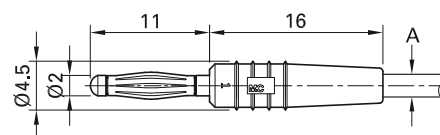

Order No.	Type	Rated voltage/current	Cable (A)			*Colors
22.2618-*	SLS205-L	30 VAC / 10 A 60 VDC / 10 A	max. Ø 2.1 mm	0.5 mm <sup>2</sup>	Au	21 22 23 24 25 26 27 28 29
22.2619-*	SLS205-L/N	30 VAC / 10 A 60 VDC / 10 A	max. Ø 2.1 mm	0.5 mm <sup>2</sup>	Ni	21 22 23 24 25 26 27 28 29

### Component parts

22.2010-*	KT2-S	Insulator
22.1009	LS205-L	Plug for SLS205-L
22.5029	LS205-L/N	Plug for SLS205-L/N



**Assembly instructions MA136**

[www.staubli.com/electrical](http://www.staubli.com/electrical)

## Socket SLS205-B

Ø 2 mm rigid for self-assembly of test leads.

Soft insulator.

**Solder connection.**

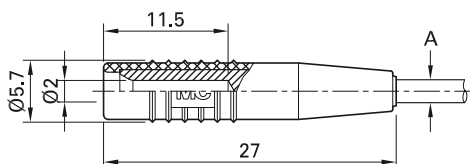

**Assembly instructions MA138**

[www.staubli.com/electrical](http://www.staubli.com/electrical)

Order No.	Type	Rated voltage/current	Cable (A)			*Colors
22.2621-*	SLS205-B	30 VAC / 10 A 60 VDC / 10 A	max. Ø 2.3 mm	0.5 mm <sup>2</sup>	Au	21 22 23

### Component parts

22.2360-*	KT205-S	Insulator
22.1038	LS205-B	Socket

## Socket SLS205-BF

Ø 2 mm with spring-loaded MULTILAM for self-assembly of test leads. Soft insulator.

**Solder connection.**

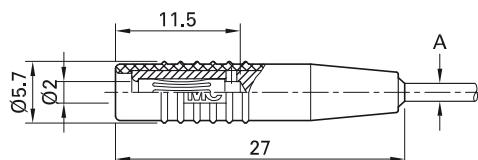

Order No.	Type	Rated voltage/current	Cable (A)		*Colors
22.2622-*	SLS205-BF	30 VAC / max. 10 A 60 VDC / max. 10 A	max. Ø 2.3 mm 0.5 mm <sup>2</sup>	Au	21 22 23

### Component parts

22.2360-*	KT205-S	Insulator
22.1039	LS205-BF	Socket



**Assembly instructions MA138**

[www.staubli.com/electrical](http://www.staubli.com/electrical)

## Press-in Socket LB2

Uninsulated Ø 2 mm rigid, made of rolled brass sheet. Mounting by pressing or soldering into holes drilled in printed circuit boards or housings.

**Solder connection.**

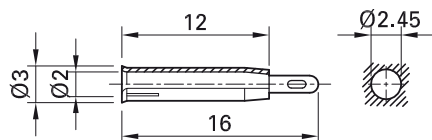

Order No.	Type	Rated voltage/current		
23.1001	LB2	30 VAC / 10 A 60 VDC / 10 A	Au	



**Press-in tool MB2, page 73**

## Solder-in Socket LB2-A

Uninsulated  $\varnothing$  2 mm rigid. Machined brass.  
The socket is soldered into predrilled panels.

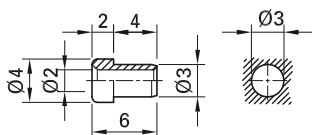

Order No.	Type	Rated voltage/current		
23.1000	LB2-A	30 VAC / 10 A 60 VDC / 10 A	Au	

## Solder-in Socket LB2-D

Uninsulated  $\varnothing$  2 mm rigid. Machined brass.  
The socket is soldered into predrilled panels.

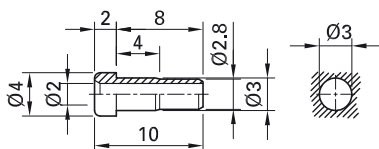

Order No.	Type	Rated voltage/current		
49.7512	LB2-D	30 VAC / 10 A 60 VDC / 10 A	Au	

## Press-in Socket EPB-2N/S

Insulated  $\varnothing$  2 mm rigid. Machined brass.  
The socket is pressed into predrilled panels

of plastic, metal etc. **Connection: Solder**  
**pin  $\varnothing$  1.5 mm.**

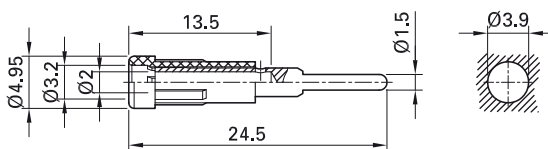

Order No.	Type	Rated voltage/current		*Colors
63.9318-*	EPB-2N/S	30 VAC / 10 A 60 VDC / 10 A	Ni	21 22 23 24 25 26 27 29



Press-in tool MB2, page 73

## Press-in Socket EB2...

Insulated Ø 2 mm rigid made of machined brass. The socket is pressed into predrilled

panels of plastic, metal etc.

### EB2

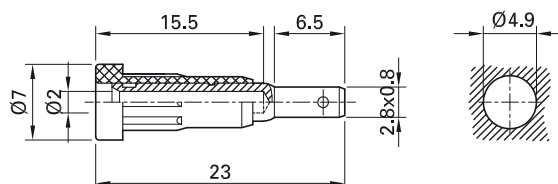

### EB2-A

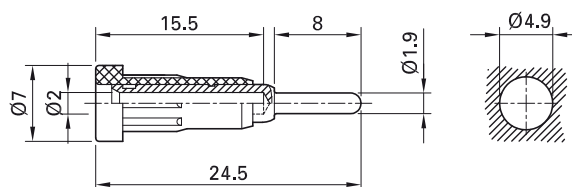

Order No.	Type	Rated voltage/current	Connection		*Colors										
23.1011-*	EB2	30 VAC / 10 A 60 VDC / 10 A	Flat connecting tab 2.8 mm x 0.8 mm	Au	<table border="1"> <tr> <td>20</td><td>21</td><td>22</td><td>23</td><td>24</td> </tr> <tr> <td>25</td><td>26</td><td>27</td><td>28</td><td>29</td> </tr> </table>	20	21	22	23	24	25	26	27	28	29
20	21	22	23	24											
25	26	27	28	29											
23.1012-*	EB2-A	30 VAC / 10 A 60 VDC / 10 A	Round connecting pin Ø 1.9 mm	Au	<table border="1"> <tr> <td>20</td><td>21</td><td>22</td><td>23</td><td>24</td> </tr> <tr> <td>25</td><td>26</td><td>27</td><td>28</td><td>29</td> </tr> </table>	20	21	22	23	24	25	26	27	28	29
20	21	22	23	24											
25	26	27	28	29											

### Component parts

23.5011-*	I-EB2	Insulator
23.5010	B-EB2	Socket for EB2
23.5002	B-EB2-A	Socket for EB2-A



Press-in tool MB2, page 73

Flat connecting receptacle FSH2,8x0,8,  
page 72



Assembly instructions MA102

[www.staubli.com/electrical](http://www.staubli.com/electrical)

## Press-in Socket EB2-F

Insulated, Ø 2 mm, spring-loaded with MULTILAM. Machined brass. The socket is pressed into predrilled panels of plastic, metal etc.

**Flat connecting tab 2.8 mm x 0.8 mm.**

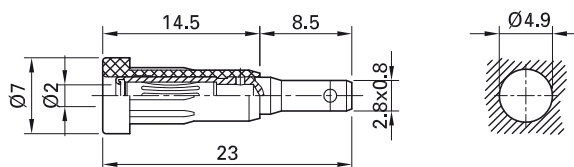

Order No.	Type	Rated voltage/current		*Colors										
23.1021-*	EB2-F	30 VAC / 10 A 60 VDC / 10 A	Opt	<table border="1"> <tr> <td>21</td> <td>22</td> <td>23</td> <td>24</td> <td>25</td> </tr> <tr> <td>26</td> <td>27</td> <td>28</td> <td>29</td> <td></td> </tr> </table>	21	22	23	24	25	26	27	28	29	
21	22	23	24	25										
26	27	28	29											

### Component parts

23.5011-*	I-EB2	Insulator
23.5005	B-EB2-F	Socket



Press-in tool MB2, page 73

Flat connecting receptacle FSH2,8x0,8,  
page 72



Assembly instructions MA102

[www.staubli.com/electrical](http://www.staubli.com/electrical)

## Panel-mount Socket LB-I2R

Insulated Ø 2 mm rigid. Machined brass. Metal thread jacket on the insulation. The socket can be screw-mounted in predrilled panels.

**Flat connecting tab 2.8 mm x 0.8 mm.**

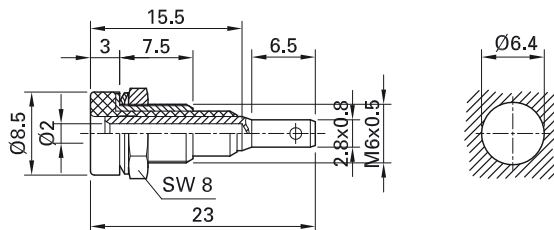
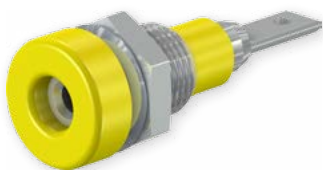

Order No.	Type	Rated voltage/current		*Colors										
23.0030-*	LB-I2R	30 VAC / 10 A 60 VDC / 10 A	Opt	<table border="1"> <tr> <td>20</td> <td>21</td> <td>22</td> <td>23</td> <td>24</td> </tr> <tr> <td>25</td> <td>26</td> <td>27</td> <td>28</td> <td>29</td> </tr> </table>	20	21	22	23	24	25	26	27	28	29
20	21	22	23	24										
25	26	27	28	29										

### Component parts

23.5059-*	BI-LB-I2R	Socket
Page 68	MU/M6x0,5	Hexagon nut
Page 69	SP2	Washer

Also available under order No. 23.0040-\* with round nut MUR/M6x0,5 (Tube spanner: SS2).



**Flat connecting receptacle FSH2,8x0,8, page 72**

## Panel-mount Socket LB2-IF

Insulated, Ø 2 mm with spring-loaded MULTILAM. The socket can be screw-mounted in predrilled panels.

**Solder connection.**

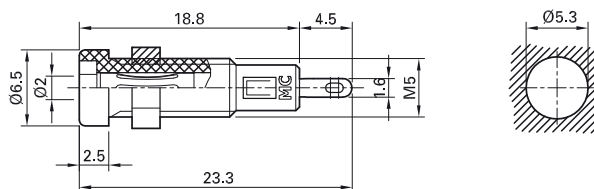

Order No.	Type	Rated voltage/current		*Colors					
23.0050-*	LB2-IF	30 VAC / 10 A 60 VDC / 10 A	Au	<table border="1"> <tr> <td>21</td> <td>22</td> <td>23</td> <td>24</td> <td>25</td> </tr> </table>	21	22	23	24	25
21	22	23	24	25					

### Component parts

23.5062-*	BI-LB2-IF	Socket
Page 68	MU/M5	Hexagon nut



## Panel-mount Socket LB-IF2R

Insulated, Ø 2 mm with spring-loaded MULTILAM. Machined brass. Metal thread jacket on the insulation. The socket can be screw-mounted in predrilled panels.

**Flat connecting tab 2.8 mm x 0.8 mm.**

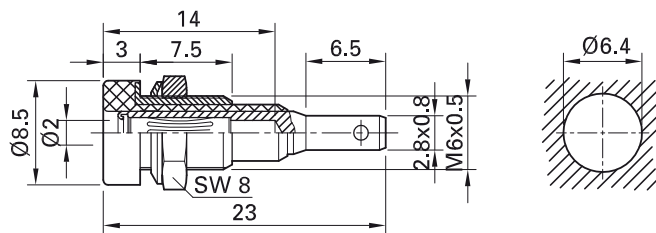
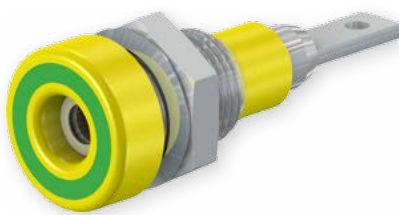

Order No.	Type	Rated voltage/current		*Colors										
23.0060-*	LB-IF2R	30 VAC / 10 A 60 VDC / 10 A	Opt	<table border="1"> <tr> <td>20</td> <td>21</td> <td>22</td> <td>23</td> <td>24</td> </tr> <tr> <td>25</td> <td>26</td> <td>27</td> <td>28</td> <td>29</td> </tr> </table>	20	21	22	23	24	25	26	27	28	29
20	21	22	23	24										
25	26	27	28	29										

### Component parts

23.5021-*	BI-LB-IF2R	Socket
Page 68	MU/M6x0,5	Hexagon nut
Page 69	SP2	Washer

Also available under order No. 23.0020-\* with round nut MUR/M6x0,5 (Tube spanner: SS2).



**Flat connecting receptacle FSH2,8x0,8, page 72**

## Binding Post PK2-T

Insulated, with Ø 2 mm rigid socket and insulated head undetachable. With Ø 2 mm cross hole for quick wire connection. Ma-

chined brass. For mounting, with anti-rotation lug, in front panels up to 4 mm thick.

**Connection: Threaded bolt M3.**

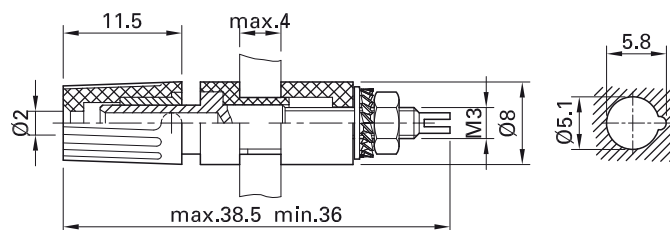

Order No.	Type	Rated voltage/current		*Colors		
23.0290-*	PK2-T	30 VAC / 15 A 60 VDC / 15 A	Ni	<table border="1"> <tr> <td>21</td> <td>22</td> </tr> </table>	21	22
21	22					

## Socket Strip BL2-.../20...

20-pole socket strips, consisting of 2 rows of 10 sockets with solder connection. No need for individual mounting of sockets:

Simplified panel drilling, orientation of solder connections and compact mounting

with only 5 screws. Available with socket spacings of 6 mm and 12 mm.

### BL2-6/20/A

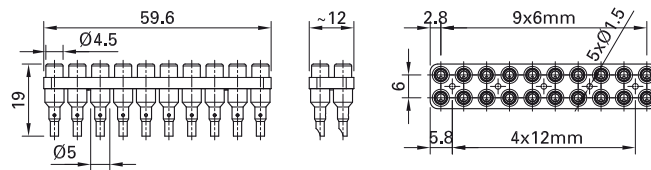

### BL2-12/20/A

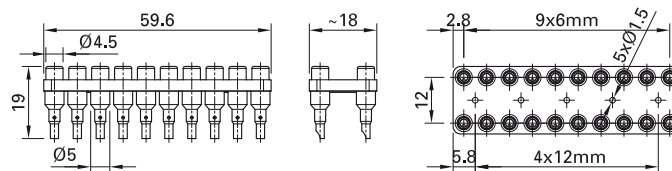

### BL2-6/20-0,65

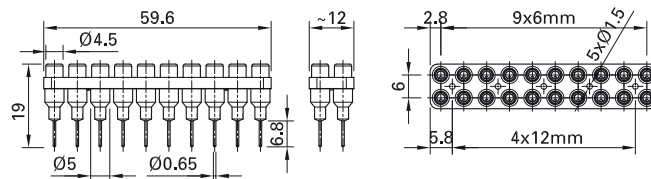
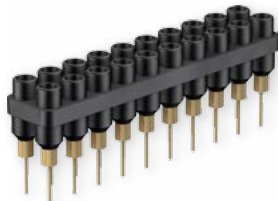

### BL2-12/20-0,65

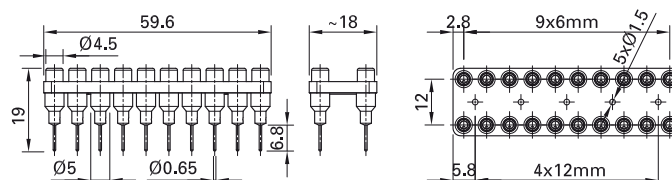
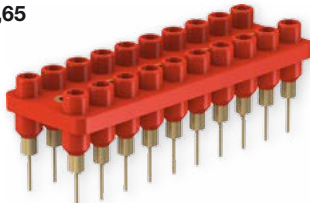

Order No.	Type	Rated voltage/current	Number of sockets	Plug spacing	Assembly instructions		*Colors <sup>1)</sup>
63.9356-*	BL2-6/20/A	30 VAC / 10 A 60 VDC / 10 A	2 x 10	6 mm	MAH559A	Au	21 22
63.9358-*	BL2-12/20/A	30 VAC / 10 A 60 VDC / 10 A	2 x 10	12 mm	MAH559B	Au	21 22 23 24 25
63.9364-*	BL2-6/20-0,65	30 VAC / 10 A 60 VDC / 10 A	2 x 10	6 mm	MAH559D	Au	21 22
63.9363-*	BL2-12/20-0,65	30 VAC / 10 A 60 VDC / 10 A	2 x 10	12 mm	MAH559C	Au	21 22

<sup>1)</sup> Other colors on request.



Assembly instructions MAH559...

[www.staubli.com/electrical](http://www.staubli.com/electrical)

# Ø 2 mm Test Probes and Clips

## Test Probe SPP2-S

With tapered, stainless steel rigid needle.  
Handle guard chamfered on both sides.  
Ø 2 mm rigid socket in handle accepting

spring-loaded Ø 2 mm plugs with rigid insulating sleeve. Supplied with protective cap.

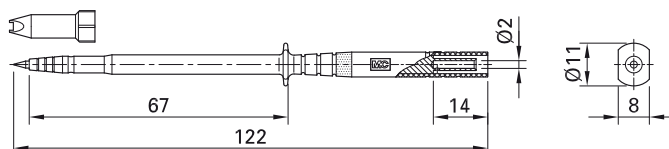

Order No.	Type	Rated voltage/current		*Colors
24.0239-*	SPP2-S	1000 V, CAT III / 1 A	CE	21 22

### Test Clip KPS1/B2

Made of hard-drawn copper alloy for grasping IC legs, plug pins and bare wire connections. Grasped objects are pressed against the tip of the insulator under spring pres-

sure. The low weight of the clip imposes hardly any load even on critical contacts. Ø 2 mm rigid socket in insulator.

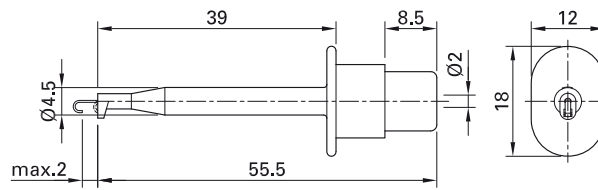

Order No.	Type	Rated voltage/current	Clamping limit		*Colors
24.0139-*	KPS1/B2	30 VAC / 1 A 60 VDC / 1 A	max. 2 mm	Au	21 22

### Test Clip AGK40

With unbreakable insulation. Fine-wire gripping surface, made of brass. Ø 2 mm rigid socket in insulator.

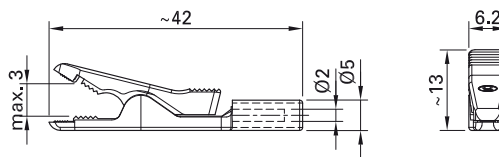

Order No.	Type	Rated voltage/current	Clamping limit		*Colors
24.0154-*	AGK40	30 VAC / 6 A 60 VDC / 6 A	max. 3 mm	Sn	21 22

# Ø 2 mm Connecting Plugs

## Connecting Plug KS2-...

Insulated, Ø 2 mm, made of brass, one piece and with spring-loaded MULTILAM.

### KS2-5,08L

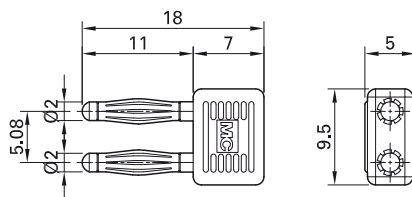
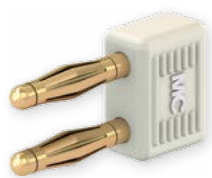

### KS2-10L/1

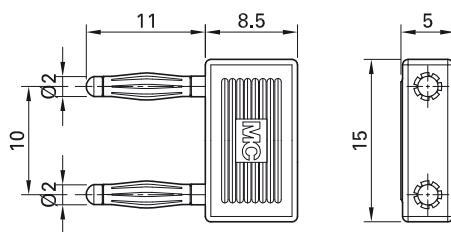

Order No.	Type	Rated voltage/current	Plug spacing		Color
24.0040-29	KS2-5,08L	30 VAC / 10 A 60 VDC / 10 A	5.08 mm	Au	29
24.0043-29	KS2-10L/1	30 VAC / 10 A 60 VDC / 10 A	10 mm	Au	29

## Connecting Plug KS2-10L

Insulated, Ø 2 mm, made of brass, one piece and with spring-loaded MULTILAM. With insulating grip.

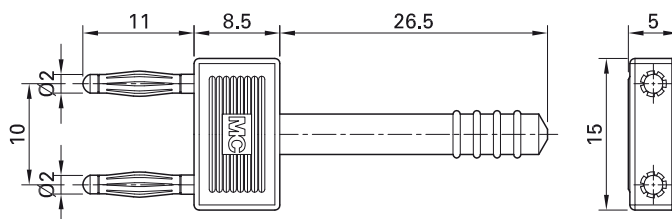

Order No.	Type	Rated voltage/current	Plug spacing		Color
24.0042-29	KS2-10L	30 VAC / 10 A 60 VDC / 10 A	10 mm	Au	29

## Connecting Plug KS2-...

Insulated, Ø 2 mm, made of brass. Equipped with spring-loaded MULTILAM to ensure vibration-proof contacts – ideal use is in the automotive field for test drives and servic-

ing. Ø 2 mm rigid socket in insulator accepting spring-loaded Ø 2 mm plugs with rigid insulating sleeve.

KS2-5,08L/1A/N



KS2-5,08L/1A/A

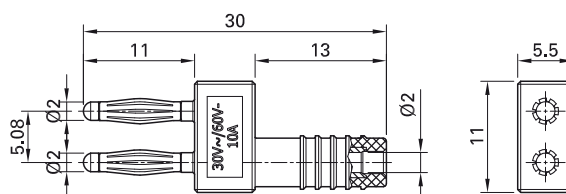

KS2-12L/1SA/N



KS2-12L/1SA/A

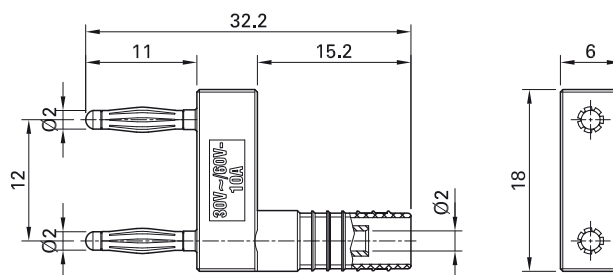

Order No.	Type	Rated voltage/current	Plug spacing		Color
63.9844-21	KS2-5,08L/1A/N	30 VAC / 10 A 60 VDC / 10 A	5.08 mm	Ni	21
63.9847-21	KS2-5,08L/1A/A	30 VAC / 10 A 60 VDC / 10 A	5.08 mm	Au	21
63.9845-21	KS2-12L/1SA/N	30 VAC / 10 A 60 VDC / 10 A	12 mm	Ni	21
63.9848-21	KS2-12L/1SA/A	30 VAC / 10 A 60 VDC / 10 A	12 mm	Au	21

## Connecting Plug KS2-...

Insulated, Ø 2 mm, with rigid Ø 2 mm socket in handling part.

KS2-6L/A



KS2-6L/N

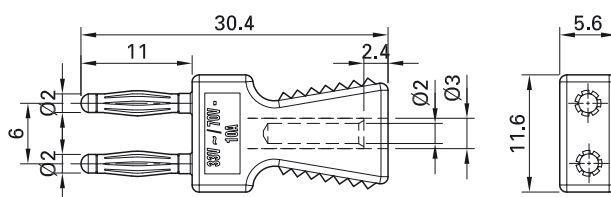
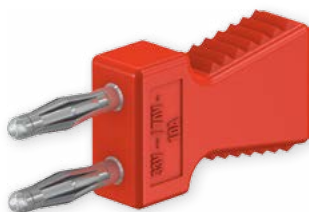

KS2-12L/A

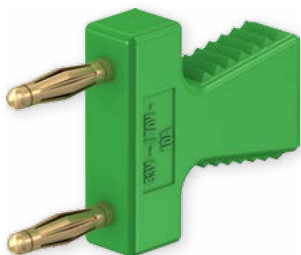

KS2-12L/N

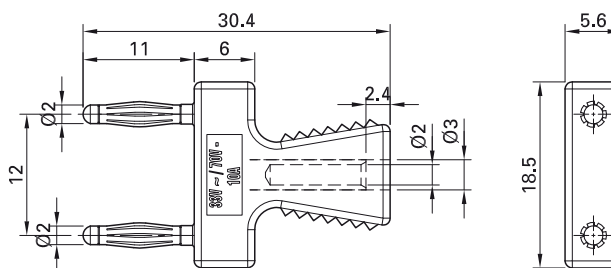
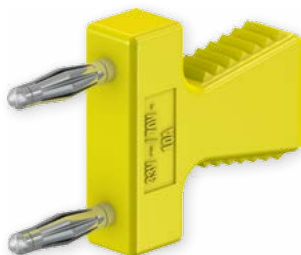

Order No.	Type	Rated voltage/current	Plug spacing	Suitable for		*Colors <sup>1)</sup>
63.9352-*	KS2-6L/A	30 VAC / 10 A 60 VDC / 10 A	6 mm	BL2-6/20/A	Au	21 22
63.9353-*	KS2-6L/N	30 VAC / 10 A 60 VDC / 10 A	6 mm	BL2-6/20/A	Ni	21 22
63.9354-*	KS2-12L/A	30 VAC / 10 A 60 VDC / 10 A	12 mm	BL2-12/20/A	Au	21 22 23 24 25
63.9355-*	KS2-12L/N	30 VAC / 10 A 60 VDC / 10 A	12 mm	BL2-12/20/A	Ni	21 22 23 24 25

Our Ø 2 mm connecting plugs KS2-..L.. are equipped with the tried and tested MULTILAM, and make a vibration-proof contact. Together with the socket strips, they are ideally suited for the saving of

space in applications such as panels for testing and servicing in the aviation industry. The gold-plated versions offer a very low contact resistance and extremely high resistance to corrosion.

<sup>1)</sup> Other colors on request.

# Ø 2 mm / Ø 4 mm Adapter and Adapter Leads

## Adapter A2/4

Ø 2 mm, made of brass, with spring-loaded MULTILAM. Ø 4 mm rigid socket in insulator

accepting spring-loaded Ø 4 mm plugs with rigid insulating sleeve.

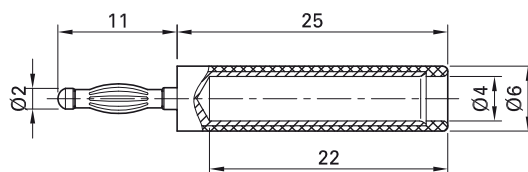

Order No.	Type	Rated voltage/current		*Colors
24.0115-*	A2/4	30 VAC / 10 A 60 VDC / 10 A	Au	21 22 23 24



RZ Sheet RZ002

[www.staubli.com/electrical](http://www.staubli.com/electrical)

## Adapter Lead AK205/410

Highly flexible. One end with Ø 2 mm stackable MULTILAM plug, the other end with Ø 4 mm stackable MULTILAM plug.

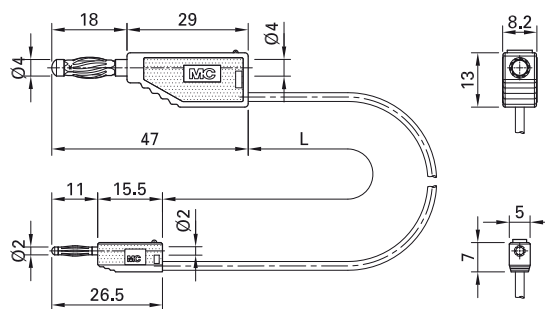

Order No.	Type	Rated voltage/current	Lead		Lead lengths L [cm]	*Colors
28.0011-□*	AK205/410	30 VAC / 10 A 60 VDC / 10 A	PVC 0.5 mm <sup>2</sup>	Au	007 (7.5 cm) 015 030 045 060	20 21 22 23 24 25 26 27 28 29



## Adapter Lead AK205/405-BK

Highly flexible. One end with Ø 2 mm stackable MULTILAM plug, the other end with

Ø 4 mm rigid socket with rigid insulating sleeve.

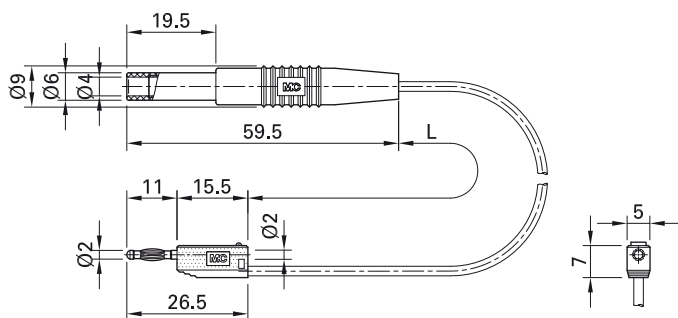

Order No.	Type	Rated voltage/current	Lead		Lead length L [cm]	*Colors
28.0012-015*	AK205/405-BK	30 VAC / 10 A 60 VDC / 10 A	PVC 0.5 mm <sup>2</sup>	Au	015	21 22



RZ Sheet RZ002

[www.staubli.com/electrical](http://www.staubli.com/electrical)

Ø 4 MM SYSTEM

Ø 4 mm Test Leads

Test Lead LK4-B

Highly flexible, with stackable Ø 4 mm hollow plugs on both ends. For information on

the many applications of our hollow plugs, see page 38.

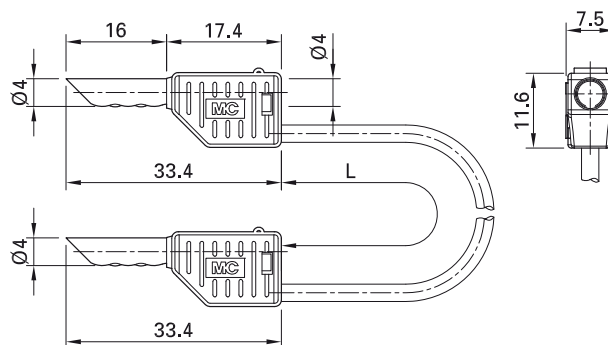
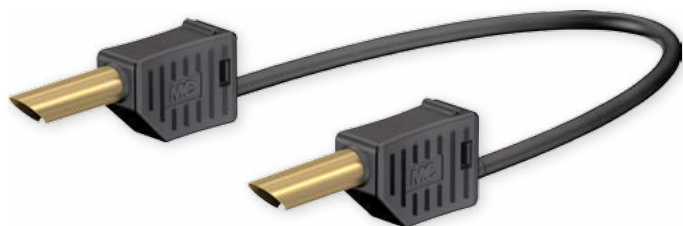

Order No.	Type	Rated voltage/current	Lead		Lead length L [cm]	*Colors
28.0055-□*	LK4-B	30 VAC / 19 A 60 VDC / 19 A	PVC 1.0 mm <sup>2</sup>	Au	025 050 075 100 150 200	21 22 23 24 25 29
28.0056-□*	LK4-B/SIL	30 VAC / 19 A 60 VDC / 19 A	SIL 1.0 mm <sup>2</sup>	Au	025 050 075 100 150 200	21 22 23 24 25

Test Lead FML SML

Highly flexible, with moulded stackable Ø 4 mm MULTILAM plugs on both ends.

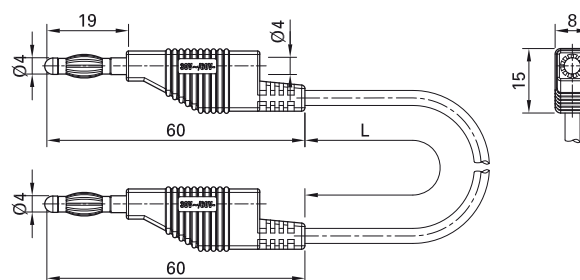
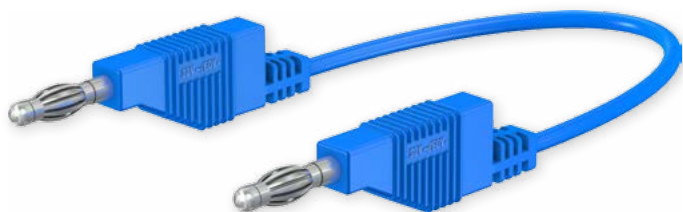

Order No.	Type	Rated voltage/current	Lead		Lead length L [cm]	*Colors
64.7289-□*	FML	30 VAC / 15 A 60 VDC / 15 A	PVC 0.75 mm <sup>2</sup>	Ni	025 050 100 150 200	21 22 23 24 25
64.7288-□*	SML	30 VAC / 15 A 60 VDC / 15 A	SIL 0.75 mm <sup>2</sup>	Ni	025 050 100 150 200	21 22 23 24 25

## Test Lead LK4...X

Highly flexible, with stackable Ø 4 mm MULTILAM plugs on both ends.

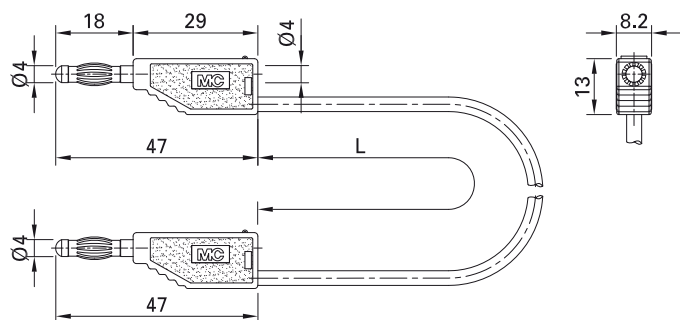
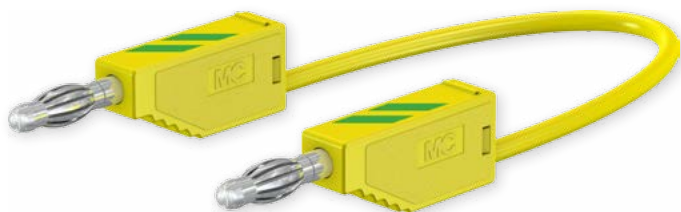

Order No.	Type	Rated voltage/current	Lead		Lead lengths L [cm]	*Colors
28.0116-□*	LK410-X	30 VAC / 19 A 60 VDC / 19 A	PVC 1.0 mm <sup>2</sup>	Ni	025 050 075 100 150 200	20 21 22 23 24 25 26 27 29
28.0119-□*	LK425-A/X	30 VAC / 32 A 60 VDC / 32 A	PVC 2.5 mm <sup>2</sup>	Ni	025 050 075 100 150 200	20 21 22 23 24 25 26 27 29

## Test Lead LK4...

Highly flexible, with stackable Ø 4 mm MULTILAM plugs on both ends.

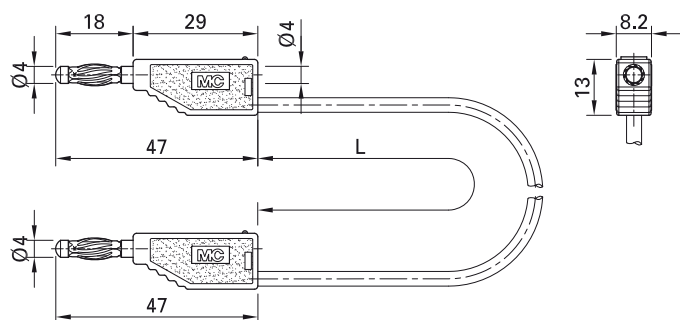
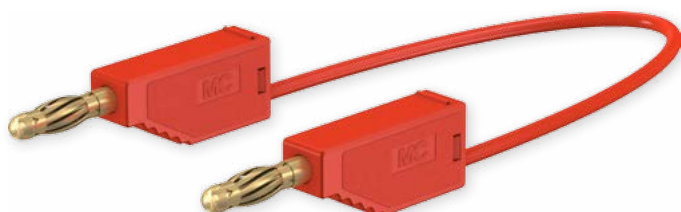

Order No.	Type	Rated voltage/current	Lead		Lead lengths L [cm]	*Colors
28.0060-□*	LK410	30 VAC / 19 A 60 VDC / 19 A	PVC 1.0 mm <sup>2</sup>	Au	025 050 075 100 150 200	20 21 22 23 24 25 26 27 28 29
28.0061-□*	LK410/SIL	30 VAC / 19 A 60 VDC / 19 A	SIL 1.0 mm <sup>2</sup>	Au	025 050 075 100 150 200	21 22 23 24 25 26
28.0073-□*	LK425-A	30 VAC / 32 A 60 VDC / 32 A	PVC 2.5 mm <sup>2</sup>	Au	025 050 075 100 150 200	20 21 22 23 24 25 26 27 28 29
28.0074-□*	LK425-A/SIL	30 VAC / 32 A 60 VDC / 32 A	SIL 2.5 mm <sup>2</sup>	Au	025 050 075 100 150 200	21 22 23 24 25

## Test Lead FAL

Highly flexible, with in-line Ø 4 mm  
MULTILAM plugs on both ends.

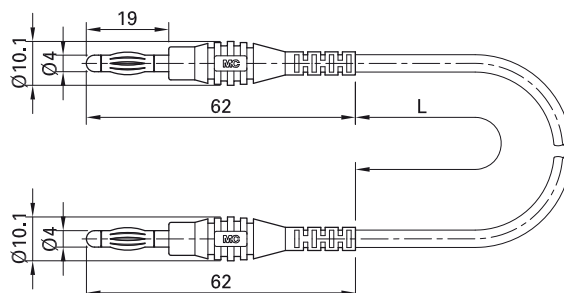

Order No.	Type	Rated voltage/current	Lead		Lead lengths L [cm]	*Colors
64.9289-□*	FAL	30 VAC / 15 A 60 VDC / 15 A	PVC 0.75 mm <sup>2</sup>	Ni	025 050 100 150 200	21 22 23 24 25

## Test Lead LK410-L

Highly flexible, with in-line Ø 4 mm  
MULTILAM plugs on both ends.

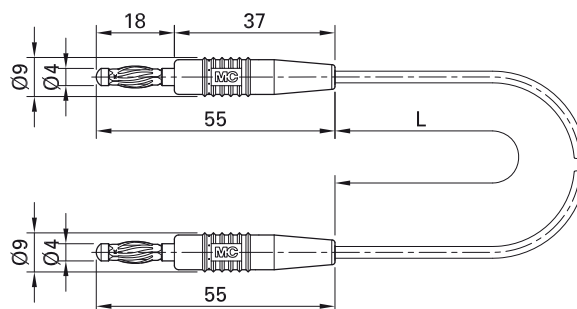

Order No.	Type	Rated voltage/current	Lead		Lead lengths L [cm]	*Colors
28.0065-□*	LK410-L	30 VAC / 19 A 60 VDC / 19 A	PVC 1.0 mm <sup>2</sup>	Au	025 050 075 100 150 200	20 21 22 23 24 25 26 27 28 29

## Coupling Lead LK4...-B

Highly flexible, with Ø 4 mm rigid sockets on both ends.

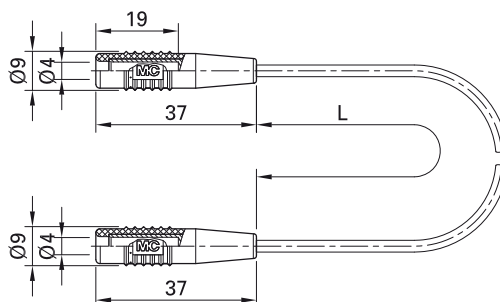
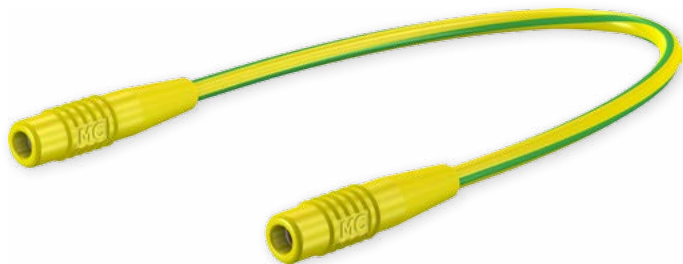

Order No.	Type	Rated voltage/current	Lead		Lead lengths L [cm]	*Colors
28.0062-□*	LK410-B	30 VAC / 19 A 60 VDC / 19 A	PVC 1.0 mm <sup>2</sup>	Au	025 050 075 100 150 200	20 21 22 23 24 25 26 27 28 29
28.0077-□*	LK425-B	30 VAC / 32 A 60 VDC / 32 A	PVC 2.5 mm <sup>2</sup>	Au	025 050 075 100 150 200	21 22 23 24 25 29

## Extension Lead AK410-L/B

Highly flexible. One end with Ø 4 mm MULTILAM plug, the other end with Ø 4 mm rigid socket.

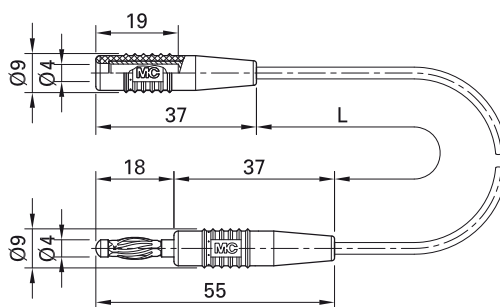

Order No.	Type	Rated voltage/current	Lead		Lead lengths L [cm]	*Colors
28.0014-□*	AK410-L/B	30 VAC / 19 A 60 VDC / 19 A	PVC 1.0 mm <sup>2</sup>	Au	025 050 075 100 150 200	20 21 22 23 24 25 26 27 28 29

# Ø 4 mm plugs and sockets

## Hollow Plug SLS4-B

Stackable, Ø 4 mm, for self-assembly of test leads. Nickel-plated and gold-plated versions available.

**Solder connection.**

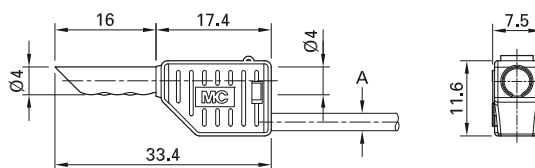

Order No.	Type	Rated voltage/current	Cable (A)	*Colors																			
22.2642-*	SLS4-B	30 VAC / 19 A 60 VDC / 19 A	<table border="0"> <tr> <td>PVC</td> <td>TPE</td> <td>Ø 2.7 mm</td> <td rowspan="2">1.0 mm<sup>2</sup></td> </tr> <tr> <td>SIL</td> <td></td> <td>Ø 3.0 mm</td> </tr> </table>	PVC	TPE	Ø 2.7 mm	1.0 mm <sup>2</sup>	SIL		Ø 3.0 mm	<table border="0"> <tr> <td>Au</td> <td>21</td> <td>22</td> <td>23</td> <td>24</td> <td>25</td> </tr> <tr> <td></td> <td>29</td> <td></td> <td></td> <td></td> <td></td> </tr> </table>	Au	21	22	23	24	25		29				
PVC	TPE	Ø 2.7 mm	1.0 mm <sup>2</sup>																				
SIL		Ø 3.0 mm																					
Au	21	22	23	24	25																		
	29																						

### Component parts

22.2060-*	KT4-B	Insulator
22.1005	LS4	Plug



### Assembly instructions MA111

[www.staubli.com/electrical](http://www.staubli.com/electrical)

## The exceptional versatility of our hollow plugs

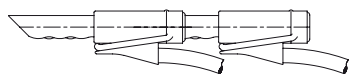

Stackable to any desired number.

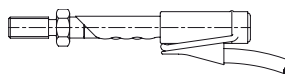

Contact to rigid or spring-loaded pins.

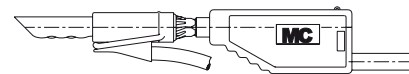

Stackable with rigid or spring-loaded pins.

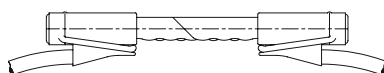

Face to face connection.

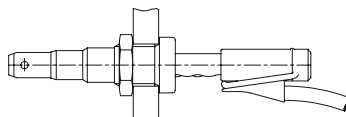

Contact to rigid or spring-loaded sockets.

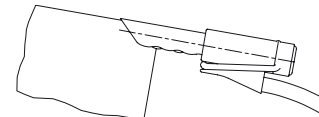

Clamping contact on edges, sheets or housing parts for earthing purposes.

## Plug SLS4...

Stackable, Ø 4 mm, with spring-loaded MULTILAM for self-assembly of test leads.

**Solder connection.**

SLS410  
SLS425-A

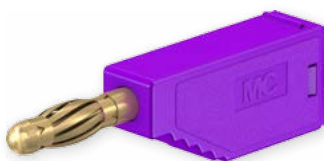

SLS410N  
SLS425-A/N

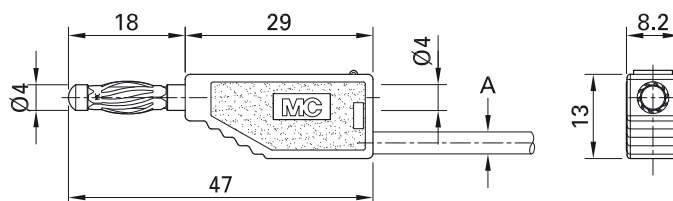

Order No.	Type	Rated voltage/current	Cable (A)		*Colors
22.2626-*	SLS410	30 VAC / 19 A 60 VDC / 19 A	PVC TPE Ø 2.7 mm SIL Ø 3.0 mm	1.0 mm <sup>2</sup>	Au 20 21 22 23 24 25 26 27 28 29
22.2627-*	SLS410N	30 VAC / 19 A 60 VDC / 19 A	PVC TPE Ø 2.7 mm SIL Ø 3.0 mm	1.0 mm <sup>2</sup>	Ni 20 21 22 23 24 25 26 27 28 29
22.2631-*	SLS425-A	30 VAC / 32 A 60 VDC / 32 A	PVC TPE Ø 3.6 mm SIL Ø 3.9 mm	2.5 mm <sup>2</sup>	Au 20 21 22 23 24 25 26 27 28 29
22.2632-*	SLS425-A/N	30 VAC / 32 A 60 VDC / 32 A	PVC TPE Ø 3.6 mm SIL Ø 3.9 mm	2.5 mm <sup>2</sup>	Ni 20 21 22 23 24 25 26 27 28 29

### Component parts

22.2140-*	KT410	Insulator for SLS410, SLS410N
22.2160-*	KT425-A	Insulator for SLS425-A, SLS425-A/N
22.1010	LS410	Plug for SLS410, SLS425-A
22.5067	LS410N	Plug for SLS410N, SLS425-A/N



Assembly instructions MA110

[www.staubli.com/electrical](http://www.staubli.com/electrical)

## Plug SLS425-A/X

Stackable, Ø 4 mm, with spring-loaded MULTILAM for self-assembly of test leads.

**Solder connection.**

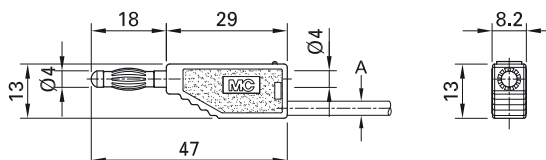
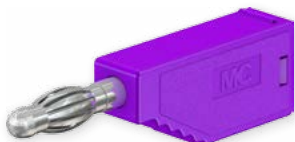

Order No.	Type	Rated voltage/current	Cable (A)		*Colors																	
22.2634-*	SLS425-A/X	30 VAC / 32 A 60 VDC / 32 A	<table border="1"> <tr> <td>PVC</td> <td>TPE</td> <td>Ø 3.6 mm</td> <td rowspan="2">2.5 mm<sup>2</sup></td> </tr> <tr> <td>SIL</td> <td></td> <td>Ø 3.9 mm</td> </tr> </table>	PVC	TPE	Ø 3.6 mm	2.5 mm <sup>2</sup>	SIL		Ø 3.9 mm	Ni	<table border="1"> <tr> <td>20</td> <td>21</td> <td>22</td> <td>23</td> <td>24</td> </tr> <tr> <td>25</td> <td>26</td> <td>27</td> <td>28</td> <td>29</td> </tr> </table>	20	21	22	23	24	25	26	27	28	29
PVC	TPE	Ø 3.6 mm	2.5 mm <sup>2</sup>																			
SIL		Ø 3.9 mm																				
20	21	22	23	24																		
25	26	27	28	29																		

### Component parts

22.2160-*	KT425-A	Insulator
22.1202	LS410-X	Plug



Assembly instructions MA110

[www.staubli.com/electrical](http://www.staubli.com/electrical)

## Plug SLS425-AM

Stackable, Ø 4 mm, with spring-loaded MULTILAM for self-assembly of test leads.

**Screw connection.**

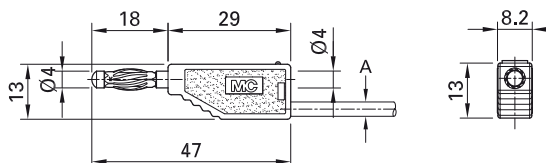
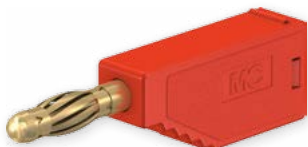

Order No.	Type	Rated voltage/current	Cable (A)		*Colors										
22.2633-*	SLS425-AM	30 VAC / 32 A 60 VDC / 32 A	~ Ø 4.0 mm 2.5 mm <sup>2</sup>	Au	<table border="1"> <tr> <td>20</td> <td>21</td> <td>22</td> <td>23</td> <td>24</td> </tr> <tr> <td>25</td> <td>26</td> <td>27</td> <td>28</td> <td>29</td> </tr> </table>	20	21	22	23	24	25	26	27	28	29
20	21	22	23	24											
25	26	27	28	29											

### Component parts

22.2160-*	KT425-A	Insulator
22.1028	LS425-AM	Plug



Assembly instructions MA110

[www.staubli.com/electrical](http://www.staubli.com/electrical)



## Plug ZGL-4...

Stackable, Ø 4 mm, with spring-loaded MULTILAM for self-assembly of test leads.  
With retractable sleeve to prevent accidental touching.

**Screw connection.**

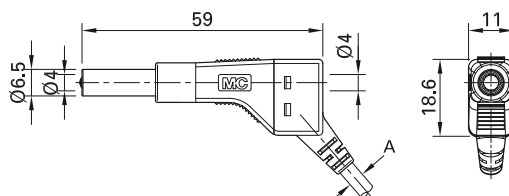

**Assembly instructions**  
**MAH555, MAH556**

[www.staubli.com/electrical](http://www.staubli.com/electrical)

Order No.	Type	Rated voltage/current	Cable (A)	Assembly instructions		*Colors										
64.9325-*	ZGL-410	30 VAC / 19 A 60 VDC / 19 A	min. Ø 3.4 mm max. Ø 3.9 mm	1.0 mm <sup>2</sup>	MAH 555	Ni <table border="1"><tr><td>20</td><td>21</td><td>22</td><td>23</td><td>24</td></tr><tr><td>25</td><td>26</td><td>27</td><td>28</td><td></td></tr></table>	20	21	22	23	24	25	26	27	28	
20	21	22	23	24												
25	26	27	28													
64.9326-*	ZGL-425	30 VAC / 32 A 60 VDC / 32 A	min. Ø 3.4 mm max. Ø 3.9 mm	2.5 mm <sup>2</sup>	MAH 556	Ni <table border="1"><tr><td>20</td><td>21</td><td>22</td><td>23</td><td>24</td></tr><tr><td>25</td><td>26</td><td>27</td><td>28</td><td></td></tr></table>	20	21	22	23	24	25	26	27	28	
20	21	22	23	24												
25	26	27	28													

## Plug SLS4...-L

In-line, Ø 4 mm, with spring-loaded MULTILAM for self-assembly of test leads.  
Soft insulator.

**Solder connection.**

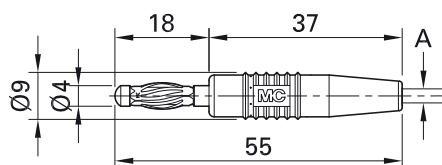

**Assembly instructions MA116**

[www.staubli.com/electrical](http://www.staubli.com/electrical)

Order No.	Type	Rated voltage/current	Cable (A)	Assembly instructions		*Colors										
22.2646-*	SLS410-L	30 VAC / 19 A 60 VDC / 19 A	Ø 3.0 mm	1.0 mm <sup>2</sup>	Au	<table border="1"><tr><td>21</td><td>22</td><td>23</td><td>24</td><td>25</td></tr><tr><td>26</td><td>27</td><td>28</td><td>29</td><td></td></tr></table>	21	22	23	24	25	26	27	28	29	
21	22	23	24	25												
26	27	28	29													
22.2648-*	SLS425-L	30 VAC / 32 A 60 VDC / 32 A	Ø 3.8 mm	2.5 mm <sup>2</sup>	Au	<table border="1"><tr><td>21</td><td>22</td><td>23</td><td>24</td><td>25</td></tr><tr><td>29</td><td></td><td></td><td></td><td></td></tr></table>	21	22	23	24	25	29				
21	22	23	24	25												
29																

### Component parts

22.2170-*	KT410-L	Insulator for SLS410-L
22.2190-*	KT425-L	Insulator for SLS425-L
22.1011	LS410-L	Plug for SLS410-L
22.1015	LS425-L	Plug for SLS425-L

## Plug L-400

In-line, Ø 4 mm, with spring-loaded MULTILAM for self-assembly of test leads.

**Solder connection.**

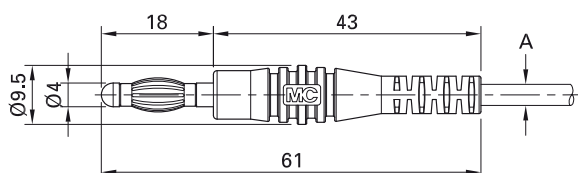

Order No.	Type	Rated voltage/current	Cable (A)		*Colors
64.9294-*	L-400	30 VAC / 32 A 60 VDC / 32 A	max. Ø 3.9 mm 2.5 mm <sup>2</sup>	Ni	21 22 23 24 25

## Plug L-409

In-line, Ø 4 mm, with spring-loaded MULTILAM for self-assembly of test leads.

**Screw connection.**

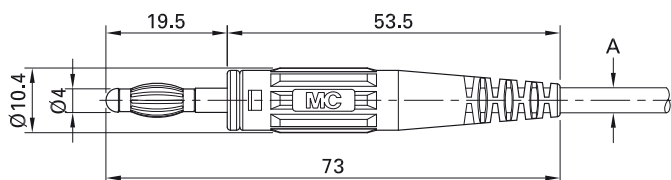

Order No.	Type	Rated voltage/current	Cable (A)		*Colors
64.9195-*	L-409	30 VAC / 32 A 60 VDC / 32 A	max. Ø 3.9 mm 2.5 mm <sup>2</sup>	Ni	21 22 23 24 25 26 27 29

## Plug L-41...

In-line, Ø 4 mm, with spring-loaded MULTILAM for self-assembly of test leads.

Type L-41Q with Ø 4 mm lateral hole for additional test connection.

**Solder connection.**

L-41



L-41Q

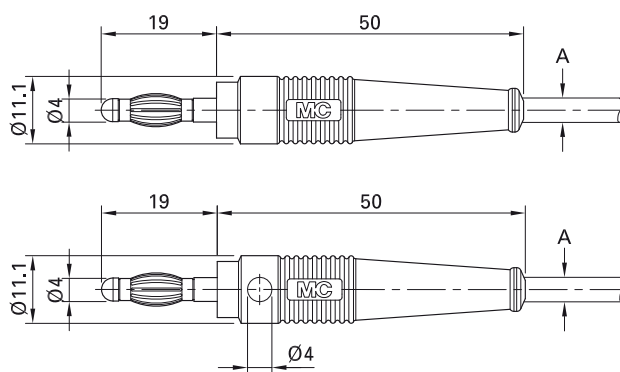

Order No.	Type	Rated voltage/current	Cable (A)		*Colors										
64.9200-*	L-41	30 VAC / 32 A 60 VDC / 32 A	max. Ø 3.9 mm 2.5 mm <sup>2</sup>	Ni	<table border="1"> <tr> <td>21</td> <td>22</td> <td>23</td> <td>24</td> <td>25</td> </tr> <tr> <td>26</td> <td>27</td> <td>29</td> <td></td> <td></td> </tr> </table>	21	22	23	24	25	26	27	29		
21	22	23	24	25											
26	27	29													
64.9199-*	L-41Q	30 VAC / 32 A 60 VDC / 32 A	max. Ø 3.9 mm 2.5 mm <sup>2</sup>	Ni	<table border="1"> <tr> <td>21</td> <td>22</td> <td>23</td> <td>24</td> <td>25</td> </tr> <tr> <td>26</td> <td>27</td> <td>29</td> <td></td> <td></td> </tr> </table>	21	22	23	24	25	26	27	29		
21	22	23	24	25											
26	27	29													

## Plug SLS425-ZL...

In-line, Ø 4 mm, with spring-loaded MULTILAM for self-assembly of test leads. With retractable sleeve to prevent accidental touching.

**Various types of connection:**  
 SLS425-ZL: Solder connection  
 SLS425-ZL/M3: Screw connection



**Assembly instructions MA130**  
[www.staubli.com/electrical](http://www.staubli.com/electrical)

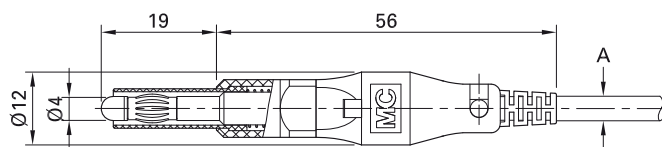

Order No.	Type	Rated voltage/current	Cable (A)	*Colors																			
22.2652-*	SLS425-ZL	30 VAC / 32 A 60 VDC / 32 A	<table border="1"> <tr> <td>PVC</td> <td>TPE</td> <td>Ø 3.7 mm</td> <td rowspan="2">2.5 mm<sup>2</sup></td> </tr> <tr> <td>SIL</td> <td></td> <td>Ø 3.9 mm</td> </tr> </table>	PVC	TPE	Ø 3.7 mm	2.5 mm <sup>2</sup>	SIL		Ø 3.9 mm	<table border="1"> <tr> <td>Ni</td> <td>21</td> <td>22</td> <td>23</td> <td>24</td> <td>25</td> </tr> <tr> <td></td> <td>29</td> <td></td> <td></td> <td></td> <td></td> </tr> </table>	Ni	21	22	23	24	25		29				
PVC	TPE	Ø 3.7 mm	2.5 mm <sup>2</sup>																				
SIL		Ø 3.9 mm																					
Ni	21	22	23	24	25																		
	29																						
22.2653-*	SLS425-ZL/M3	30 VAC / 32 A 60 VDC / 32 A	<table border="1"> <tr> <td>PVC</td> <td>TPE</td> <td>Ø 3.7 mm</td> <td rowspan="2">2.5 mm<sup>2</sup></td> </tr> <tr> <td>SIL</td> <td></td> <td>Ø 3.9 mm</td> </tr> </table>	PVC	TPE	Ø 3.7 mm	2.5 mm <sup>2</sup>	SIL		Ø 3.9 mm	<table border="1"> <tr> <td>Ni</td> <td>21</td> <td>22</td> <td>23</td> <td>24</td> <td>25</td> </tr> <tr> <td></td> <td>29</td> <td></td> <td></td> <td></td> <td></td> </tr> </table>	Ni	21	22	23	24	25		29				
PVC	TPE	Ø 3.7 mm	2.5 mm <sup>2</sup>																				
SIL		Ø 3.9 mm																					
Ni	21	22	23	24	25																		
	29																						

### Component parts

50.1138-*	KT425-ZL	Insulator
49.2030	LS425-ZL	Plug for SLS425-ZL
49.2029	LS425-ZL/M3	Plug for SLS425-ZL/M3

## Plug GL-438

In-line, Ø 4 mm, with spring-loaded MULTILAM for self-assembly of test leads.

With retractable sleeve to prevent accidental touching.

**Screw connection.**

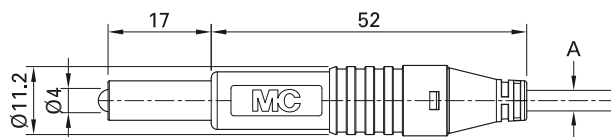

Order No.	Type	Rated voltage/current	Cable (A)	*Colors						
64.9701-*	GL-438	30 VAC / 32 A 60 VDC / 32 A	<table border="1"> <tr> <td>max. Ø 3.9 mm</td> <td>2.5 mm<sup>2</sup></td> </tr> </table>	max. Ø 3.9 mm	2.5 mm <sup>2</sup>	<table border="1"> <tr> <td>Ni</td> <td>21</td> <td>22</td> <td>23</td> </tr> </table>	Ni	21	22	23
max. Ø 3.9 mm	2.5 mm <sup>2</sup>									
Ni	21	22	23							



**Assembly instructions MAH522**  
[www.staubli.com/electrical](http://www.staubli.com/electrical)

## Socket SLS4...-B

Ø 4 mm, rigid, for self-assembly of test leads. Soft insulator.

**Solder connection.**

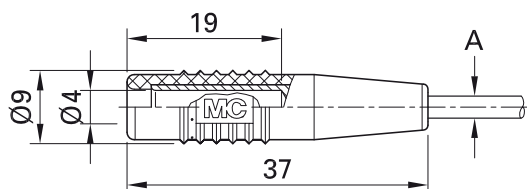

Order No.	Type	Rated voltage/current	Cable (A)		*Colors
22.2649-*	SLS410-B	30 VAC / 19 A 60 VDC / 19 A	max. Ø 3.0 mm 1.0 mm <sup>2</sup>	Au	21 22 23 24 25 26 27 28 29
22.2651-*	SLS425-B	30 VAC / 32 A 60 VDC / 32 A	max. Ø 4.0 mm 2.5 mm <sup>2</sup>	Au	21 22 23 24 25 29

### Component parts

22.2170-*	KT410-L	Insulator for SLS410-B
22.2190-*	KT425-L	Insulator for SLS425-B
22.1012	LS410-B	Socket for SLS410-B
22.1016	LS425-B	Socket for SLS425-B



**Assembly instructions MA117**

[www.staubli.com/electrical](http://www.staubli.com/electrical)

## Socket K-41

Ø 4 mm rigid, for self-assembly of test leads.

**Solder connection.**

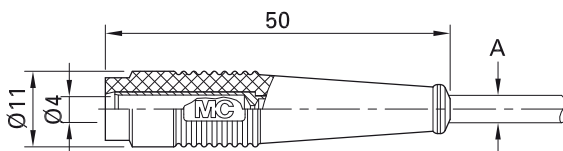

Order No.	Type	Rated voltage/current	Cable (A)		*Colors
64.9201-*	K-41	30 VAC / 32 A 60 VDC / 32 A	max. Ø 3.9 mm 2.5 mm <sup>2</sup>	Ni	21 22 23 24 25 26 27 29

## Clip-on Plug KLS4

Ø 4 mm, with spring-loaded MULTILAM for clamp-connecting stranded wires.

**Clamp connection.**

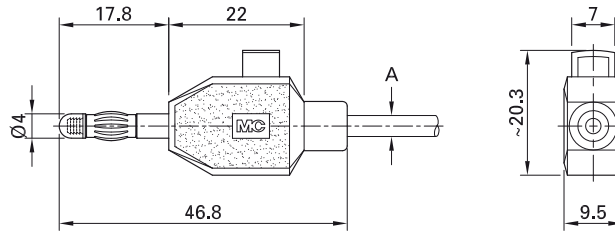
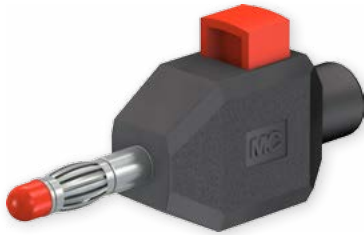

Order No.	Type	Rated voltage/current	Cable (A)		*Colors
22.3006-*	KLS4	30 VAC / 10 A 60 VDC / 10 A	max. Ø 4.8mm 2.5 mm <sup>2</sup>	Ni	21 22



RZ Sheet RZ023

[www.staubli.com/electrical](http://www.staubli.com/electrical)

## Press-in Socket LB4...

Uninsulated, Ø 4 mm, rigid, made of rolled brass sheet. The socket is pressed into predrilled plastic panels or soldered into

printed circuit boards. Nickel-plated and gold-plated versions available.

**Solder connection.**

LB4



LB4N

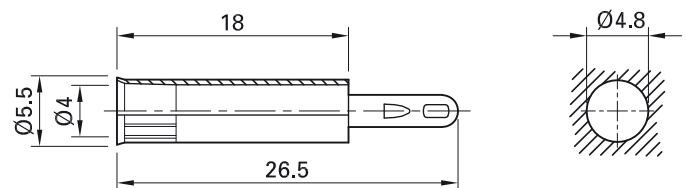

Order No.	Type	Rated voltage/current		
23.1003	LB4	30 VAC / 25 A 60 VDC / 25 A	Au	
23.5326	LB4N	30 VAC / 25 A 60 VDC / 25 A	Ni	

## Press-in Socket LB4-A

Uninsulated, Ø 4 mm, rigid, made of punched brass tubing. The socket is pressed into pre-

drilled plastic panels or soldered into printed circuit boards.

**Solder connection.**

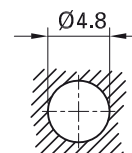
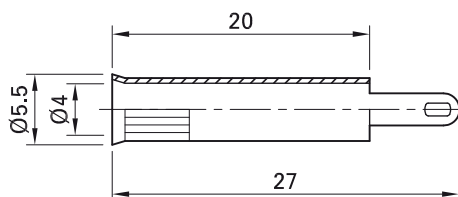
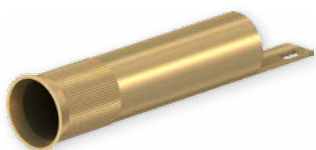

Order No.	Type	Rated voltage/current		
23.1004	LB4-A	30 VAC / 25 A 60 VDC / 25 A	Au	

## Press-in Socket EB4

Insulated, Ø 4 mm, rigid. Machined brass. The socket is pressed into predrilled panels of plastic, metal etc.

**Flat connecting tab 4.8 mm x 0.8 mm.**

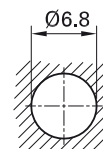
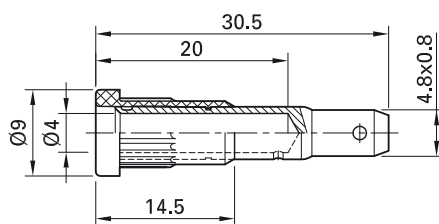
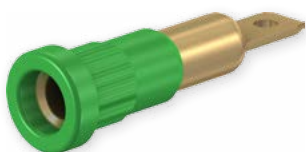

Order No.	Type	Rated voltage/current		*Colors										
23.1013-*	EB4	30 VAC / 25 A 60 VDC / 25 A	Au	<table border="1"> <tr> <td>20</td> <td>21</td> <td>22</td> <td>23</td> <td>24</td> </tr> <tr> <td>25</td> <td>26</td> <td>27</td> <td>28</td> <td>29</td> </tr> </table>	20	21	22	23	24	25	26	27	28	29
20	21	22	23	24										
25	26	27	28	29										

### Component parts

23.5013-*	I-EB4	Insulator
23.5012	B-EB4	Socket



Assembly instructions MA103

[www.staubli.com/electrical](http://www.staubli.com/electrical)



Press-in tool MB4, page 73

Flat connecting receptacle FSH4,8x0,8,  
page 72

## Press-in Socket EB4-A...

Insulated, Ø 4 mm, rigid. Machined brass.  
The socket is pressed into predrilled panels of plastic, metal etc. Nickel-plated and gold-plated versions available.

**Round connecting pin Ø 1.9 mm.**

EB4-A



EB4-A/N

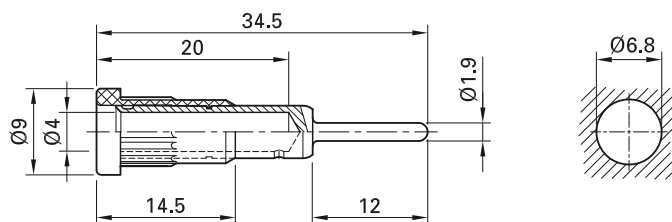

Order No.	Type	Rated voltage/current		*Colors										
23.1014-*	EB4-A	30 VAC / 25 A 60 VDC / 25 A	Au	<table border="1"> <tr> <td>20</td><td>21</td><td>22</td><td>23</td><td>24</td> </tr> <tr> <td>25</td><td>26</td><td>27</td><td>28</td><td>29</td> </tr> </table>	20	21	22	23	24	25	26	27	28	29
20	21	22	23	24										
25	26	27	28	29										
49.7077-*	EB4-A/N	30 VAC / 25 A 60 VDC / 25 A	Ni	<table border="1"> <tr> <td>20</td><td>21</td><td>22</td><td>23</td><td>24</td> </tr> <tr> <td>25</td><td>26</td><td>27</td><td>28</td><td>29</td> </tr> </table>	20	21	22	23	24	25	26	27	28	29
20	21	22	23	24										
25	26	27	28	29										

### Component parts

23.5013-*	I-EB4	Insulator
23.5014	B-EB4-A	Socket for EB4-A
23.5025	B-EB4-A/N	Socket for EB4-A/N



Press-in tool MB4, page 73



Assembly instructions MA103

[www.staubli.com/electrical](http://www.staubli.com/electrical)



## Press-in Socket EB4-B

Insulated, Ø 4 mm, rigid. Brass sheet, punched and rolled. The socket is pressed into predrilled panels of plastic, metal etc.

**Flat connecting tab 4.8 mm x 0.8 mm**, can be bent to 90°, once only.

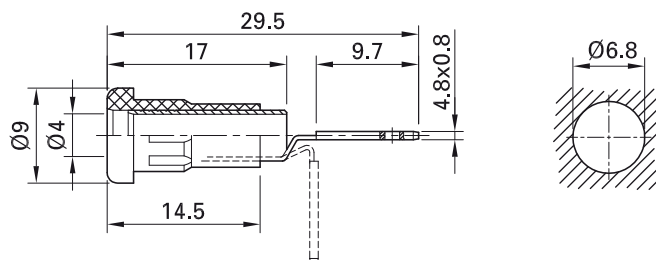

Order No.	Type	Rated voltage/current		*Colors										
23.1015-*	EB4-B	30 VAC / 25 A 60 VDC / 25 A	Ni	<table border="1"> <tr> <td>20</td> <td>21</td> <td>22</td> <td>23</td> <td>24</td> </tr> <tr> <td>25</td> <td>26</td> <td>27</td> <td>28</td> <td>29</td> </tr> </table>	20	21	22	23	24	25	26	27	28	29
20	21	22	23	24										
25	26	27	28	29										

### Component parts

23.5019-*	I-EB4-B	Insulator
23.5026	B-EB4-B	Socket



Press-in tool MB4, page 73

Flat connecting FSH4,8x0,8, page 72



Assembly instructions MA103

[www.staubli.com/electrical](http://www.staubli.com/electrical)

## Press-in Socket EB4-C

Insulated, Ø 4 mm, rigid. Machined brass.  
The socket is pressed into predrilled panels of plastic, metal etc.

**Round connecting pin Ø 1.2 mm.**

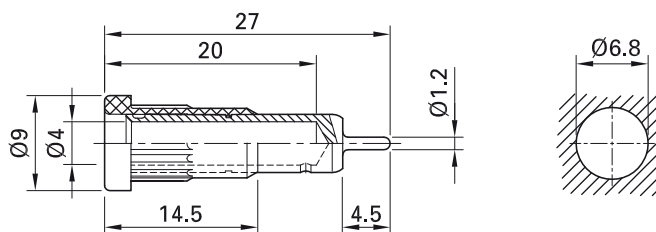

Order No.	Type	Rated voltage/current		*Colors										
23.1016-*	EB4-C	30 VAC / 25 A 60 VDC / 25 A	Au	<table border="1"> <tr> <td>20</td> <td>21</td> <td>22</td> <td>23</td> <td>24</td> </tr> <tr> <td>25</td> <td>26</td> <td>27</td> <td>28</td> <td>29</td> </tr> </table>	20	21	22	23	24	25	26	27	28	29
20	21	22	23	24										
25	26	27	28	29										

### Component parts

23.5013-*	I-EB4	Insulator
23.5308	B-EB4-C	Socket



Press-in tool MB4, page 73



Assembly instructions MA103

[www.staubli.com/electrical](http://www.staubli.com/electrical)

## Earth socket LB4-R...

Uninsulated, Ø 4 mm, rigid. Machined brass. The sockets can be screw-mounted in pre-

drilled panels.

**Solder connection.**

LB4-R



LB4-R/A

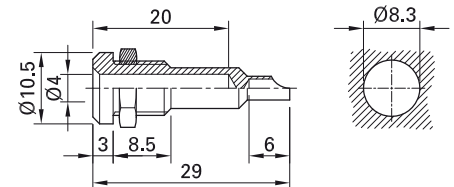

Order No.	Type	Rated voltage/current		
23.0090	LB4-R	30 VAC / 40 A 60 VDC / 40 A	Ni	
23.0470	LB4-R/A	30 VAC / 40 A 60 VDC / 40 A	Au	

### Component parts

23.5044	B-LB4-R	Socket without nut for LB4-R
23.5339	B-LB4-R/A	Socket without nut for LB4-R/A
Page 68	MU/M8x0,5	Hexagonal Nuts
Page 69	SP4	Washer

## Earth Socket MSLB4-G

Uninsulated, Ø 4 mm, rigid, accepting spring-loaded Ø 4 mm plugs with rigid insu-

lating sleeve. Machined brass. The socket can directly be mounted in predrilled metal panels.

**Connection: Threaded bolt M4.**

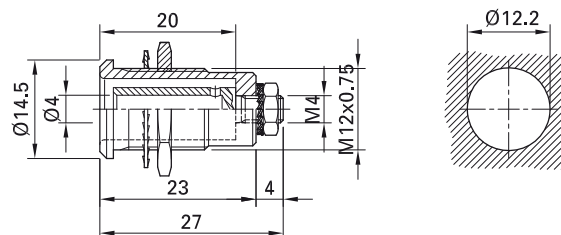

Order No.	Type	Rated voltage/current		
23.3090	MSLB4-G	30 VAC / 32 A 60 VDC / 32 A	Ni	

### Supplied assembly material

Page 68	MU/M12x0,75	Hexagonal Nuts
Page 68	MU0,5D/M4N	Hexagonal Nuts
Page 68	MU/M8x0,5	Hexagonal Nuts
Page 69	SP4	Washer
Page 70	FS/M12	Spring Washers
Page 70	FS/M4	Spring Washers

## Panel-mount Socket LB4-R/I

Insulated, Ø 4 mm, rigid. Machined brass.  
The socket can be screw-mounted in pre-drilled panels.

**Solder connection.**

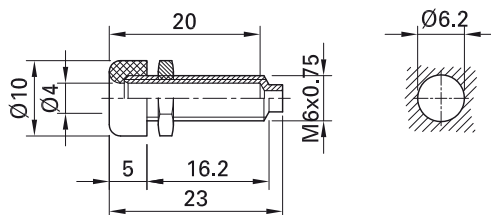

Order No.	Type	Rated voltage/current		*Colors
49.7068-*	LB4-R/I	30 VAC / 20 A 60 VDC / 20 A	Ni	21 22

### Component parts

49.7090-*	BI-LB4-R/I	Socket without nut
Page 68	MUE/M6x0,75	Hexagonal Nuts

## Panel-mount Socket EBI-40

Insulated, Ø 4 mm, rigid. Machined brass.  
The socket can be screw-mounted in pre-drilled panels.

**Threaded bolt M6x0.75 and solder connection.**

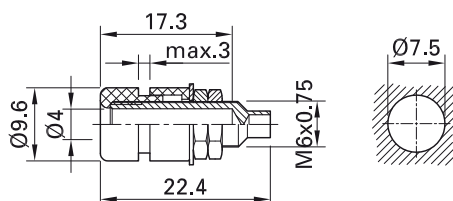

Order No.	Type	Rated voltage/current		*Colors
69.8321-*	EBI-40	30 VAC / 20 A 60 VDC / 20 A	Ni	21 22 23 24 25 29

## Panel-mount Socket LB-I4R

Insulated, Ø 4 mm, rigid. Machined brass. Metal thread jacket on the insulation. The socket can be screw-mounted in predrilled panels. Available with hexagonal or round nut.

**Solder connection.**

### LB-I4R

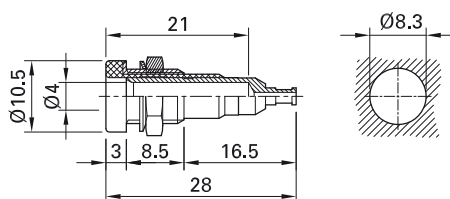

### LB-I4R

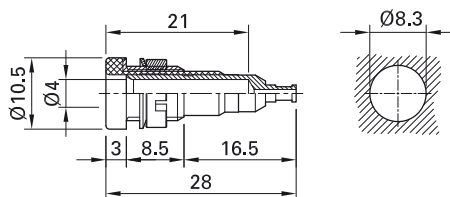

Order No.	Type	Rated voltage/current	Nut		*Colors										
23.0110-*	LB-I4R	30 VAC / 25 A 60 VDC / 25 A	Hexagonal nut	Opt	<table border="1"> <tr> <td>20</td> <td>21</td> <td>22</td> <td>23</td> <td>24</td> </tr> <tr> <td>25</td> <td>26</td> <td>27</td> <td>28</td> <td>29</td> </tr> </table>	20	21	22	23	24	25	26	27	28	29
20	21	22	23	24											
25	26	27	28	29											
23.0100-*	LB-I4R	30 VAC / 25 A 60 VDC / 25 A	Round nut	Opt	<table border="1"> <tr> <td>20</td> <td>21</td> <td>22</td> <td>23</td> <td>24</td> </tr> <tr> <td>25</td> <td>26</td> <td>27</td> <td>28</td> <td>29</td> </tr> </table>	20	21	22	23	24	25	26	27	28	29
20	21	22	23	24											
25	26	27	28	29											

### Component parts

23.6111-*	BI-LB-I4R	Socket without nut
Page 68	MU/M8x0,5	Hexagonal Nuts
Page 69	MUR/M8x0,5	Round Nut
Page 69	SP4	Washer

## Panel-mount Socket LB-I4R-B

Insulated, Ø 4 mm, rigid. Rolled brass sheet.  
The socket can be screw-mounted in pre-drilled panels.

**Solder connection.**

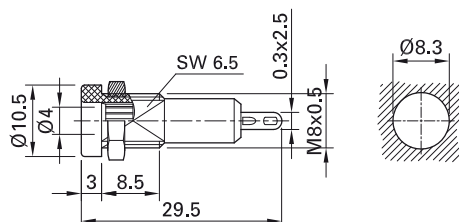

Order No.	Type	Rated voltage/current		*Colors
23.0450-*	LB-I4R-B	30 VAC / 25 A 60 VDC / 25 A	Ni	21 22 23 24 25 29

### Component parts

23.8111-*	BI-LB-I4R-B	Socket without nut
Page 68	MU/M8x0,5	Hexagonal Nuts

## Panel-mount Socket LB-I4Q

Insulated, Ø 4 mm, rigid. Machined brass.  
Metal thread jacket on the insulation. The socket can be screw-mounted in predrilled panels.

**Solder connection.**

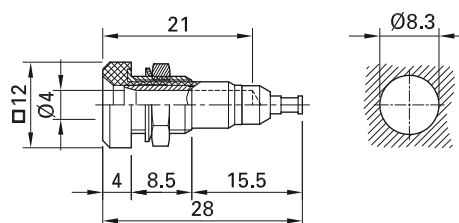
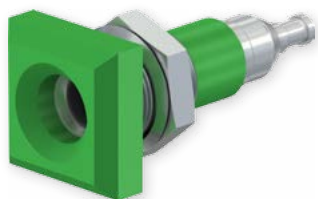

Order No.	Type	Rated voltage/current		*Colors
23.0120-*	LB-I4Q	30 VAC / 25 A 60 VDC / 25 A	Opt	21 22 23 24 25 26 29

### Component parts

23.6222-*	BI-LB-I4Q	Socket without nut
Page 68	MU/M8x0,5	Hexagonal Nuts
Page 69	SP4	Washer

## Panel-mount Socket LB-I4R-A

Insulated, Ø 4 mm, rigid. Machined brass.  
Metal thread jacket on the insulation. The socket can be screw-mounted in predrilled panels. Available with hexagonal nut.

**Flat connecting tab 4.8 mm x 0.8 mm.**

LB-I4R-A

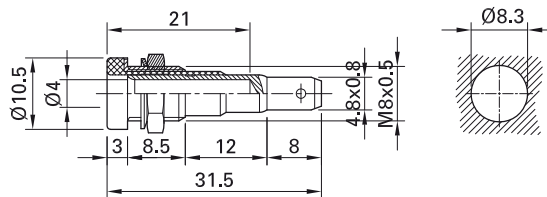
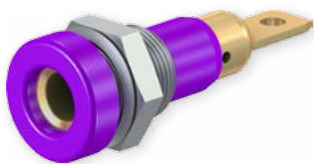

LB-I4R-A

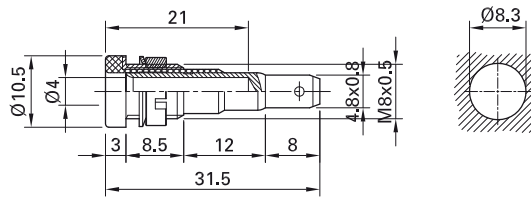

Order No.	Type	Rated voltage/current	Nut		*Colors										
23.0190-*	LB-I4R-A	30 VAC / 25 A 60 VDC / 25 A	Hexagonal nut	Au	<table border="1"> <tr> <td>20</td><td>21</td><td>22</td><td>23</td><td>24</td> </tr> <tr> <td>25</td><td>26</td><td>27</td><td>28</td><td>29</td> </tr> </table>	20	21	22	23	24	25	26	27	28	29
20	21	22	23	24											
25	26	27	28	29											
23.0180-*	LB-I4R-A	30 VAC / 25 A 60 VDC / 25 A	Round Nut	Au	<table border="1"> <tr> <td>20</td><td>21</td><td>22</td><td>23</td><td>24</td> </tr> <tr> <td>25</td><td>26</td><td>27</td><td>28</td><td>29</td> </tr> </table>	20	21	22	23	24	25	26	27	28	29
20	21	22	23	24											
25	26	27	28	29											

### Component parts

23.6333-*	BI-LB-I4R-A	Socket without nut
Page 68	MU/M8x0,5	Hexagonal Nuts
Page 69	MUR/M8x0,5	Round Nut
Page 69	SP4	Washer



Flat connecting FSH4,8x0,8, page 72

## Panel-mount Socket LB-IF4R-A

Insulated, Ø 4 mm, with spring-loaded MULTILAM. Machined brass. Metal thread jacket on the insulation. The socket can be screw-mounted in predrilled panels.

**Flat connecting tab 4.8 mm x 0.8 mm.**

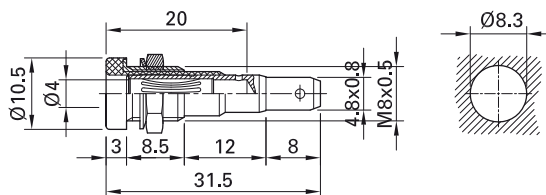

Order No.	Type	Rated voltage/current		*Colors										
23.0210-*	LB-IF4R-A	30 VAC / 25 A 60 VDC / 25 A	Opt	<table border="1"> <tr> <td>20</td> <td>21</td> <td>22</td> <td>23</td> <td>24</td> </tr> <tr> <td>25</td> <td>26</td> <td>27</td> <td>28</td> <td>29</td> </tr> </table>	20	21	22	23	24	25	26	27	28	29
20	21	22	23	24										
25	26	27	28	29										

### Component parts

23.6666-*	BI-LB-IF4R-A	Socket without nut
Page 68	MU/M8x0,5	Hexagonal Nuts
Page 69	SP4	Washer



**Flat connecting FSH4,8x0,8, page 72**



## Panel-mount Socket LB-IF4R

Insulated, Ø 4 mm, with spring-loaded MULTILAM. Machined brass. Metal thread jacket on the insulation. The socket can be screw-mounted in predrilled panels. Available with hexagonal or round nut.

**Solder connection.**

### LB-IF4R

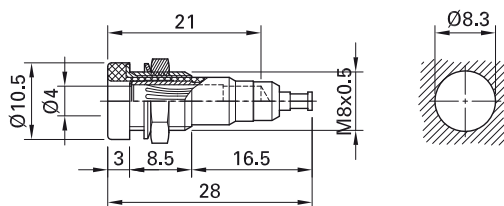

### LB-IF4R

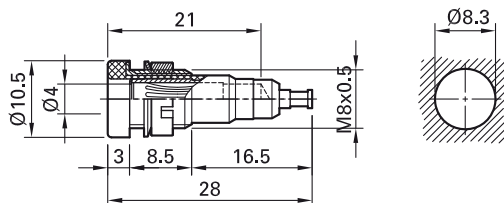

Order No.	Type	Rated voltage/current	Nut		*Colors										
23.0140-*	LB-IF4R	30 VAC / 25 A 60 VDC / 25 A	Hexagonal nut	Opt	<table border="1"> <tr> <td>20</td> <td>21</td> <td>22</td> <td>23</td> <td>24</td> </tr> <tr> <td>25</td> <td>26</td> <td>27</td> <td>28</td> <td>29</td> </tr> </table>	20	21	22	23	24	25	26	27	28	29
20	21	22	23	24											
25	26	27	28	29											
23.0130-*	LB-IF4R	30 VAC / 25 A 60 VDC / 25 A	Round Nut	Opt	<table border="1"> <tr> <td>20</td> <td>21</td> <td>22</td> <td>23</td> <td>24</td> </tr> <tr> <td>25</td> <td>26</td> <td>27</td> <td>28</td> <td>29</td> </tr> </table>	20	21	22	23	24	25	26	27	28	29
20	21	22	23	24											
25	26	27	28	29											

### Component parts

23.6444-*	BI-LB-IF4R	Socket without nut
Page 68	MU/M8x0,5	Hexagonal Nuts
Page 69	MUR/M8x0,5	Round Nut
Page 69	SP4	Washer

## Panel-mount Socket LB-I4/2P

Insulated, Ø 4 mm, rigid. Machined brass.  
The socket can be screw-mounted in pre-drilled panels.

**Solder connection.**

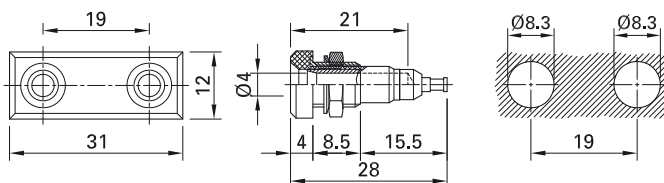
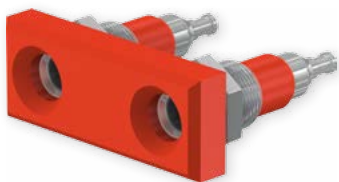

Order No.	Type	Rated voltage/current		*Colors
23.2000-*	LB-I4/2P	30 VAC / 25 A 60 VDC / 25 A	Opt	21 22

### Component parts

23.6777-*	BI-LB-I4/2P	Socket without nut
Page 68	2 × MU/M8x0,5	Hexagonal Nuts
Page 69	2 × SP4	Washer

## Binding Post PK4-T

Insulated, Ø 4 mm, rigid, and insulated head undetachable. Ø 2.5 mm cross hole for quick wire connection. Machined brass.

For mounting, with anti-rotation lug, in front panels up to 4 mm thick.

**Connection: Threaded bolt M4.**

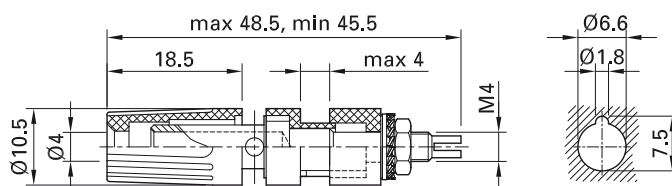

Order No.	Type	Rated voltage/current		*Colors
23.0330-*	PK4-T	30 VAC / 35 A 60 VDC / 35 A	Ni	20 21 22 23 24 25 29

# Ø 4 mm Test Probes and Clips

## Test Probe PP-130

With stainless steel needle, ground to a sharp point, eg. for piercing thin insulation and oxide layers. The insulation can be cut

back in steps to bare a suitable length of tip. The test probe features an anti-roll finger

guard. Ø 4 mm rigid socket in handle. Supplied with protective cap.

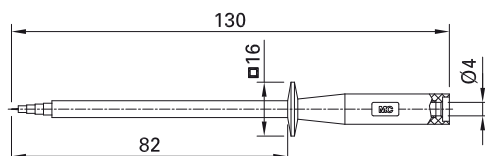



Order No.	Type	Rated voltage/current		*Colors
64.9205-*	PP-130	30 VAC / 1 A 60 VDC / 1 A		21 22 23 24 25

## Test Clip SKPS-4

With flexible shaft and spring wire grabber (stainless steel) for a good contact to pins and wires in inaccessible places. Especially suitable for measuring voltages. The shaft is silicone insulated and guarantees good

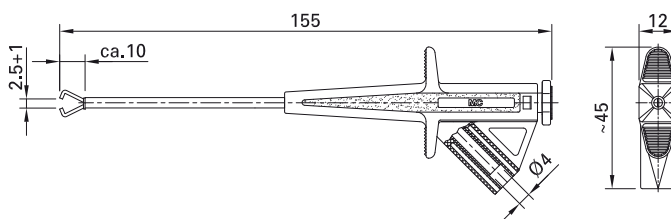
heat resistance and flexibility even at low temperatures. Ø 4 mm rigid socket in handle accepting spring-loaded Ø 4 mm plugs with rigid insulating sleeve.



Order No.	Type	Rated voltage/current		*Colors
24.0224-*	SKPS-4	1000 V, CAT III / 4 A	CE  US	21 22 23

## Test Clip GRIP-A

With rigid hook clip made of steel for hooking onto wires. Ø 4 mm rigid socket in hand-

dle accepting spring-loaded Ø 4 mm plugs with rigid insulating sleeve.

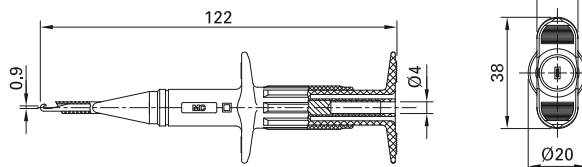

Order No.	Type	Rated voltage/current		*Colors
66.9116-*	GRIP-A	1000 V, CAT III / 3 A	CE c UL US	21 22 23

## Test Clip AGK20

Uninsulated, with Ø 4 mm rigid socket. Steel. Connection also possible with screw clamp or soldering.

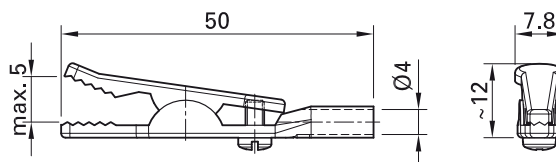

Order No.	Type	Rated voltage/current		
24.0149	AGK20	30 VAC / 10 A 60 VDC / 10 A	Ni	

## Test Clip APK-4

Insulated, with Ø 4 mm rigid socket. Brass. Sharp toothed, pointed jaws. The upper jaw is insulated.

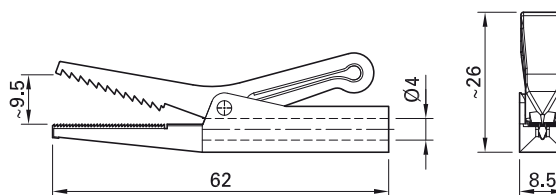

Order No.	Type	Rated voltage/current		*Colors
64.9209-*	APK-4	30 VAC / 10 A 60 VDC / 10 A	Ni	21 22 23 24 25

# Ø 4 mm Connecting Plugs

## Connecting Plug KS4-1...

Insulated, Ø 4 mm, made of brass. Equipped with spring-loaded MULTILAM to ensure vibration-proof contacts – ideal use is in the automotive field for test drives and servic-

ing. Ø 4 mm rigid socket in insulator accepting spring-loaded Ø 4 mm plugs with rigid insulating sleeve.

KS4-11L/1A/N



KS4-11L/1A/A

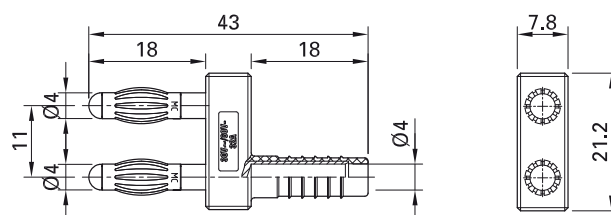

KS4-14LA/N



KS4-14LA/A

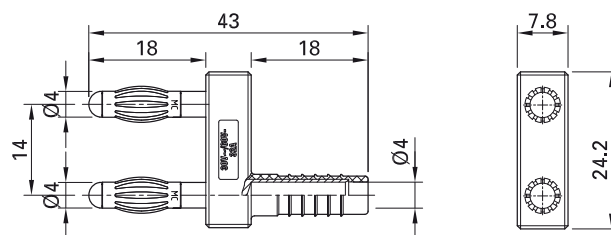

Order No.	Type	Rated voltage/current	Plug spacing		Color
64.9302-21	KS4-11L/1A/N	30 VAC / 32 A 60 VDC / 32 A	11 mm	Ni	21
64.9301-21	KS4-11L/1A/A	30 VAC / 32 A 60 VDC / 32 A	11 mm	Au	21
20.1010-21	KS4-14LA/N	30 VAC / 32 A 60 VDC / 32 A	14 mm	Ni	21
20.1020-21	KS4-14LA/A	30 VAC / 32 A 60 VDC / 32 A	14 mm	Au	21

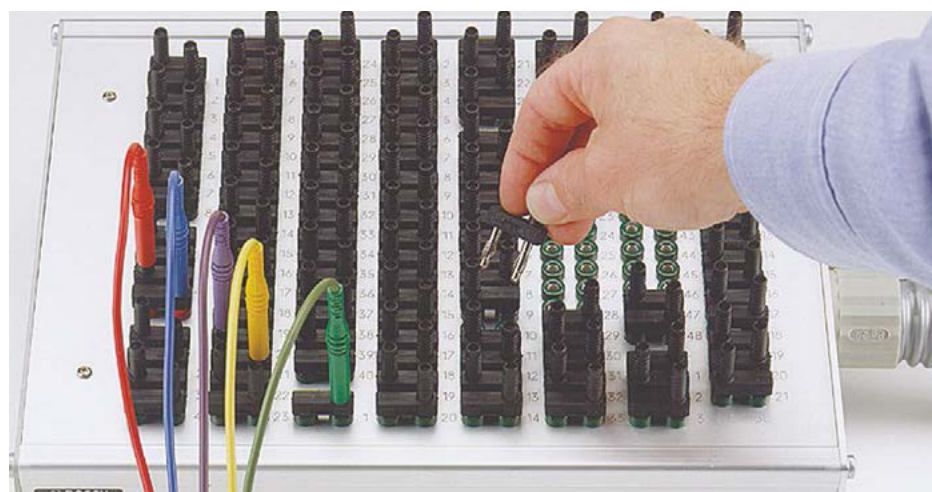

## Connecting Plug KS4-1...

Insulated, Ø 4 mm. Hollow plug, made from a single piece of hard-drawn copper alloy.

Type KS4-14 with Ø 4 mm rigid socket in insulator for tap connection at rear.

KS4-14

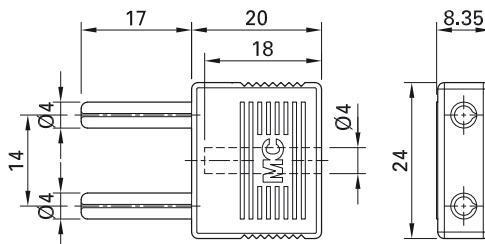

KS4-19

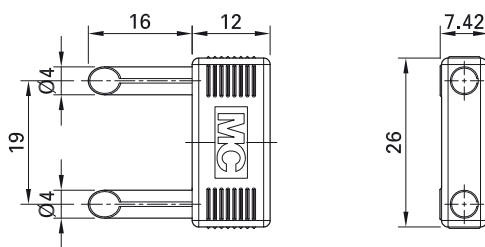

Order No.	Type	Rated voltage/current	Plug spacing		Color
24.0004-28	KS4-14	30 VAC / 25 A 60 VDC / 25 A	14 mm	Au	28
24.0002-21	KS4-19	30 VAC / 25 A 60 VDC / 25 A	19 mm	Au	21

## Connecting Plug KS4-19L

Insulated, Ø 4 mm. Made of brass, one piece and with spring-loaded MULTILAM.

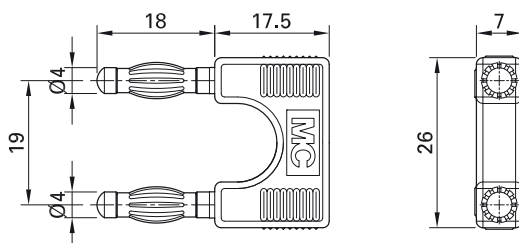

Order No.	Type	Rated voltage/current	Plug spacing		Color
24.0020-28	KS4-19L	30 VAC / 32 A 60 VDC / 32 A	19 mm	Au	28

## Connecting Plug KS4-19L/1

Insulated, Ø 4 mm, made of brass. Plugs with spring-loaded MULTILAM. With insulated grip and with two in-line Ø 4 mm rigid

sockets accepting spring-loaded Ø 4 mm plugs with rigid insulating sleeve.

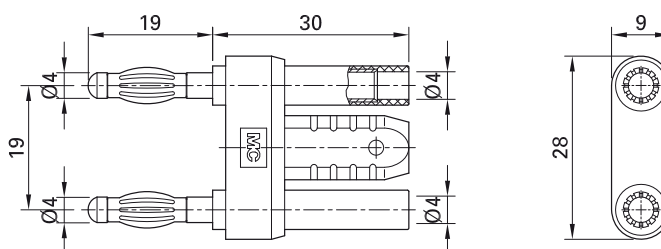

Order No.	Type	Rated voltage/current	Plug spacing		Color
24.0027-21	KS4-19L/1	30 VAC / 32 A 60 VDC / 32 A	19 mm	Ni	21

# Ø 4 mm Adapters

## Reducer Adapter R4/2

Uninsulated, Ø 4 mm plug, made of brass, with spring-loaded MULTILAM. Ø 2 mm rigid

socket, accepting spring-loaded Ø 2 mm plugs (pluggable on both sides).

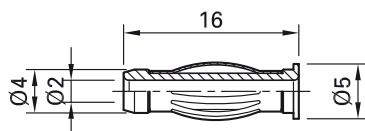

Order No.	Type	Rated voltage/current		
24.0110	R4/2	30 VAC / 25 A 60 VDC / 25 A	Au	

## Reducer Adapter R4/2-A

Insulated, Ø 4 mm plug, made of brass, with spring-loaded MULTILAM. Ø 2 mm rigid

socket in insulator accepting spring-loaded Ø 2 mm plugs (pluggable on both sides).

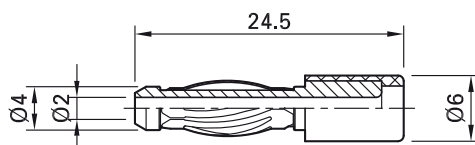

Order No.	Type	Rated voltage/current		*Colors
24.0106-*	R4/2-A	30 VAC / 25 A 60 VDC / 25 A	Au	21 22 23 24



### Plug Adapter A4/4-Z

Ø 4 mm plug, made of brass, with spring-loaded MULTILAM and retractable sleeve to prevent accidental contact.

Ø 4 mm rigid socket in insulator accepting spring-loaded Ø 4 mm plugs with rigid insulating sleeve.

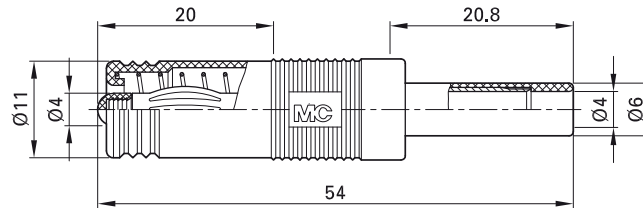

Order No.	Type	Rated voltage/current		Color
24.0116-22	A4/4-Z	30 VAC / 25 A 60 VDC / 25 A	Ni	22



RZ Sheet RZ002

[www.staubli.com/electrical](http://www.staubli.com/electrical)

### Plug Adapter LS410-I

Ø 4 mm plug, made of brass, with spring-loaded MULTILAM. Ø 4 mm rigid

socket in insulator accepting spring-loaded Ø 4 mm plugs with rigid insulating sleeve.

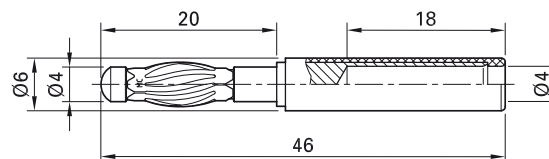

Order No.	Type	Rated voltage/current		*Colors
22.5163-*	LS410-I	30 VAC / 30 A 60 VDC / 30 A	Ni	21 22



RZ Sheet RZ098

[www.staubli.com/electrical](http://www.staubli.com/electrical)

## Screw-in Adapter B4-E-M5-I

Insulated screw-in adapter with M5 external thread for screw connection to threaded holes. Machined brass. Ø 4 mm rigid

socket in insulator accepting spring-loaded Ø 4 mm plugs with rigid insulating sleeve. Socket with internal slot for screwdriver.

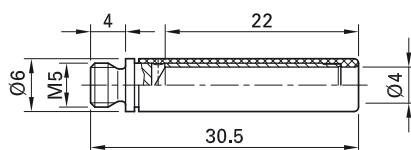

Order No.	Type	Rated voltage/current	Thread		*Colors
23.1034-*	B4-E-M5-I	30 VAC / 30 A 60 VDC / 30 A	M5	Ni	21 22 23 24

### Component parts

24.5012-*	I-A2/4	Insulator
23.5085	B4-E-M5	Uninsulated adapter



### RZ Sheet RZ002

[www.staubli.com/electrical](http://www.staubli.com/electrical)

## Test Plug PS2,3

Ø 2.3 mm plug, made of silver-plated brass with spring-loaded MULTILAM, suitable for installation terminals with threaded holes

M3. Ø 4 mm rigid socket in insulator accepting spring-loaded Ø 4 mm plugs with rigid insulating sleeve.

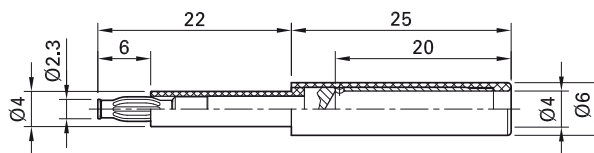

Order No.	Type	Rated voltage/current		*Colors
24.0100-*	PS2,3	30 VAC / 25 A 60 VDC / 25 A	Ag	21 22



### RZ Sheet RZ002

[www.staubli.com/electrical](http://www.staubli.com/electrical)

## Test Plug A-SLK4-RG

Ø 4 mm, made of brass with spring-loaded MULTILAM for connecting into rail mounted terminals with Ø 4 mm sockets. Ø 4 mm rigid

socket in insulator accepting spring-loaded Ø 4 mm plugs with rigid insulating sleeve.

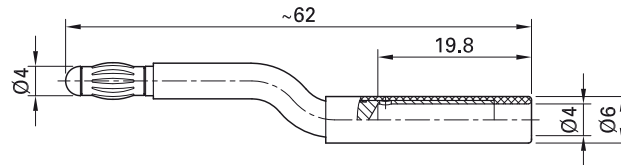

Order No.	Type	Rated voltage/current		Color
24.0164-21	A-SLK4-RG	30 VAC / 25 A 60 VDC / 25 A	Ni	21



RZ Sheet RZ002

[www.staubli.com/electrical](http://www.staubli.com/electrical)

## Adapter Lead BST-45

Highly flexible. One end with touch-protected BNC male connector, other end with stackable Ø 4 mm MULTILAM plugs.

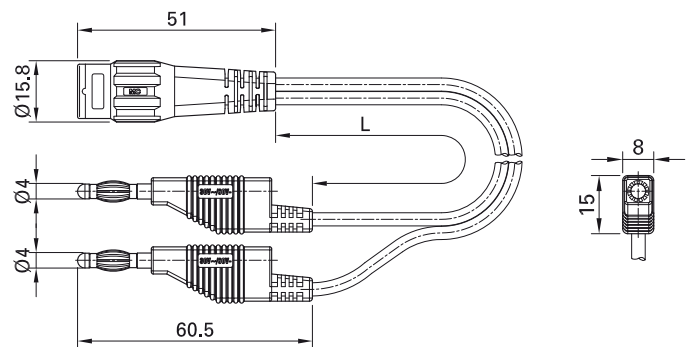
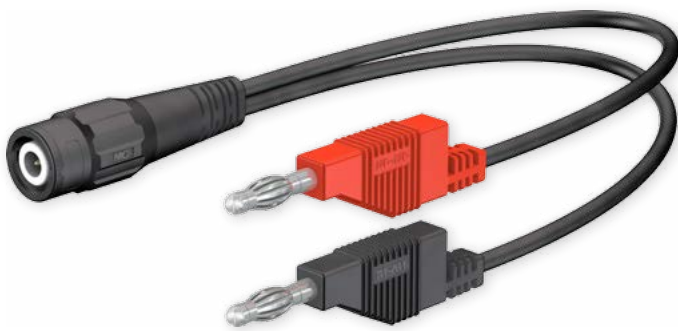

Order No.	Type	Rated voltage/current	Lead cross section	Lead lengths L [cm]
67.9417-025	BST-45	30 VAC 60 VDC	SIL 2 x 0.5 mm <sup>2</sup>	025

ASSEMBLY MATERIAL AND ACCESSORIES

# Assembly Material and Accessories

## Hexagonal Nuts MU.../M... GEW.12-MUTTER

For installing and connecting our panel-mount sockets and terminals.

MU0,5D/M4N



MU0,8D/M4 MU0,8D/M4N



MU/M5



MU/M6x0,5



MUE/M6x0,75



MU/M8x0,5



MU/M12x0,75



GEW.12-MUTTER

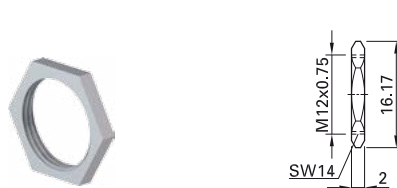

Order No.	Type	Wrench size	Thread	
22.6610	MU0,5D/M4N	SW7	M4	Ni
22.6509	MU0,8D/M4	SW7	M4	Au
22.6539	MU0,8D/M4N	SW7	M4	Ni
23.5103	MU/M5	SW6	M5	Ni
23.5104	MU/M6x0,5	SW8	M6x0.5	Ni
50.2008	MUE/M6x0,75	SW8	M6x0.75	Ni
23.5112	MU/M8x0,5	SW10	M8x0.5	Ni
23.5118	MU/M12x0,75	SW15	M12x0.75	Ni
66.9679	GEW.12-MUTTER	SW14	Gew. 12	Ni

## Round Nuts MUR...

For installing and connecting our panel-mount sockets and terminals.

**MUR/M6x0,5**

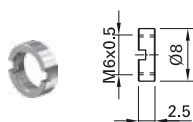

**MUR/M8x0,5**

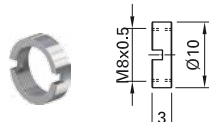

**MUR/M12x0,75**

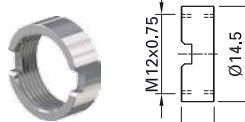

**MUR-S/M12x0,75**



Order No.	Type	Suitable tube spanner	Thread	
23.5100	MUR/M6x0,5	SS2	M6x0.5	Ni
23.5110	MUR/M8x0,5	SS4	M8x0.5	Ni
23.5120	MUR/M12x0,75	SS425	M12x0.75	Ni
23.5116	MUR-S/M12x0,75	SS425	M12x0.75	Ni

## Washers SP2 U/M4 U/4,3x12 SSP4 SP4

**SP2**

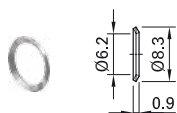

**U/M4**

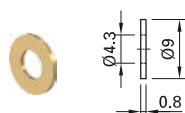

**U/4,3x12**

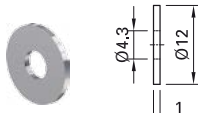

**SSP4**

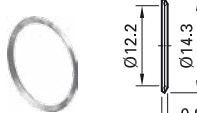

**SP4**

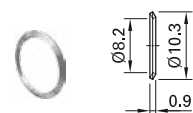

Order No.	Type	
23.5105	SP2	Ni
22.6511	U/M4	Au
22.6516	U/4,3x12	Sn
23.5108	SSP4	Ni
23.5107	SP4	Ni

## Spring Washers FS/M...

FS/M4

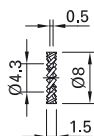

FS/M12

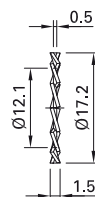

Order No.	Type	
22.6533	FS/M4	
23.5117	FS/M12	Ni

## Protective Cap SCHUDE-SLB SD-XUB

To cover up unplugged, unused sockets.

SCHUDE-SLB

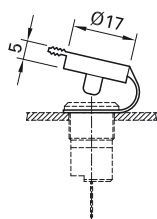

SD-XUB

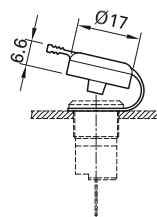

Order No.	Type	Suitable for socket types	Protection degree	Color
23.5140-33	SCHUDE-SLB	SEB4..., SLB4..., XE..-1R(R)	IP65	33
66.1020-21	SD-XUB	XUB-G, XEP...	IP67	21



Assembly instructions MAH560 (SD-XUB)

[www.staubli.com/electrical](http://www.staubli.com/electrical)

## Safety Hood SCHUKA-SLB

Designed for a touch-protected cover-up of connecting parts of sockets.

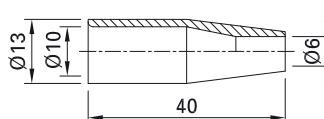

Order No.	Type	Suitable for socket types	Color
23.5142-33	SCHUKA-SLB	SEB4..., SLB4..., XE...-1R(R)	33

## Spacer Sleeves XAS-1R ID-SAB4-G

To increase the height of the mounting position of sockets and terminals.

### XAS-1R

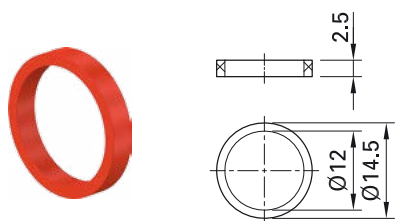

### ID-SAB4-G

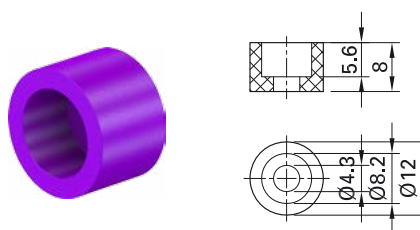

Order No.	Type	Suitable for socket types	*Colors
66.9151-*	XAS-1R	SEB4..., SLB4..., XE...-1R(R)	21 22 23 24
23.5039-*	ID-SAB4-G	SAB4-G	21 22 23 24 25 26 27 28 29

## Flat Connecting Receptacles FSH...

Gold-plated, for sockets with flat connecting tabs.

**FSH2,8x0,8**

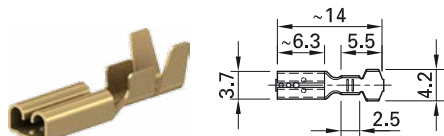

**FSH4,8x0,8**

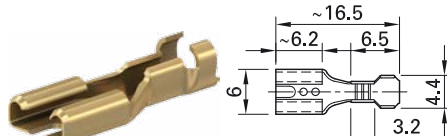

**FSH6,3x0,8**

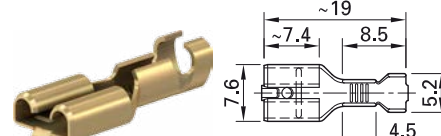

Order No.	Type	Suitable for flat connecting tab	Connectable conductor cross-section	
23.5200	FSH2,8x0,8	2.8 mm × 0.8 mm	0.5 mm <sup>2</sup> ... 1.0 mm <sup>2</sup>	Au
23.5201	FSH4,8x0,8	4.8 mm × 0.8 mm	0.5 mm <sup>2</sup> ... 1.0 mm <sup>2</sup>	Au
23.5203	FSH6,3x0,8	6.3 mm × 0.8 mm	1.0 mm <sup>2</sup> ... 2.5 mm <sup>2</sup>	Au

## Tube Spanners SS...

Special wrench for tightening and unscrewing round nuts or for use as anti-twist wrench for our touch-protected sockets.

**SS2**



**SS425**



**SS6**



Order No.	Type	To fit round nuts / socket
25.0022	SS2	XEB-..., SLB4-..., SAB4-...
25.0020	SS425	MUR/M12x0,75, MUR-S/M12x0,75
25.0023	SS2-S	SLB2-...
25.0021	SS4	MUR/M8x0,5
14.5008	SS6	M18x1



## Hexagonal Wrenches STS1,5

Uninsulated type (hexagonal 1.5 mm).



Order No.	Type	Version
25.0035	STS1,5	uninsulated

## Press-in Tools MB...

Steel assembly mandrels for our press-fit sockets.

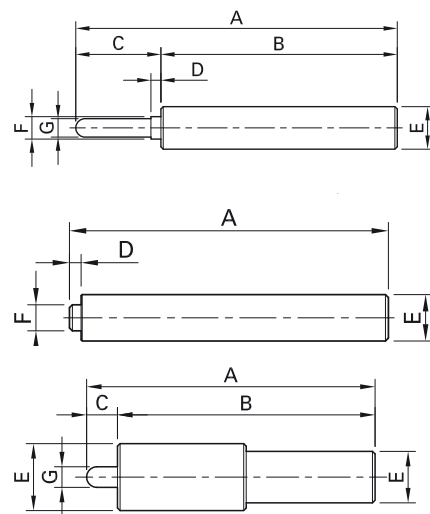
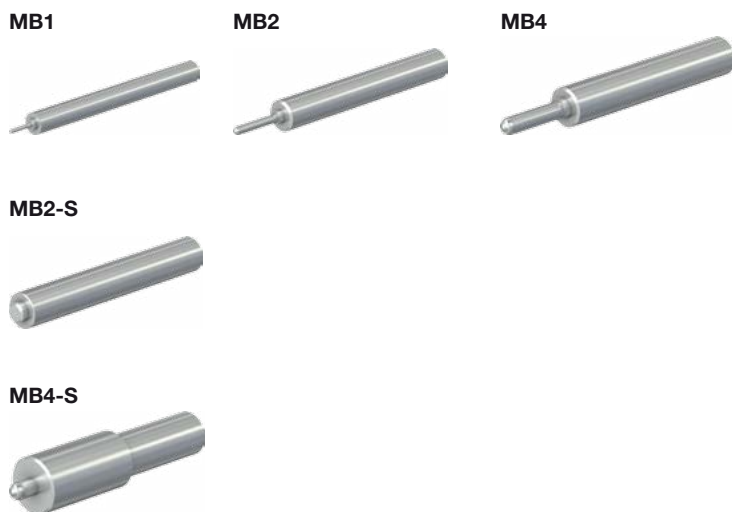

Order No.	Type	Suitable for socket types	Dimensions (mm)						
			A	B	C	D	E	F	G
25.0030	MB1	EB1	56.9	50	6.9	0.9	Ø 5	Ø 2.4	Ø 1
25.0031	MB2	LB2, EPB-2N/S, EB2, EB2-A	63.5	50	13.5	1.6	Ø 7	Ø 3	Ø 1.9
25.0028	MB2-S	SEB2-...	55	53	-	2	Ø 8	Ø 4.5	-
25.0032	MB4	EB4-...	68	50	18	2.1	Ø 9	Ø 4.75	Ø 3.9
25.0033	MB4-S	XEP..., SEB4-..., XUB-G	56	50	6	-	Ø 10/13	-	Ø 4

## Insulation Stripping Pincers STRIPAX

With automatic adaptation to wire cross-section and with wire-cutter for cross-sections up to 4 mm<sup>2</sup>.



Order No.	Type	Wire cross-section range	Overall length	Weight
25.0015	STRIPAX	0.5 mm <sup>2</sup> ... 4 mm <sup>2</sup> (AWG 20 - 11)	200 mm	145 g

### Accessories

25.5015	STRIPAX/M	Spare blade		
---------	-----------	-------------	--	--

## Crimping Pliers PZK3

For end-sleeves from 0.5 mm<sup>2</sup> up to 16 mm<sup>2</sup>. Suitable especially for LS425-SL or LS425-SL/N.



Order No.	Type	Overall length	Weight
25.0018	PZK3	228 mm	236 g

## Test Lead Holders LKW2-N

Trolley made of anodized aluminium square section tube for orderly storage of test leads. 2 lead holders (length: 56 cm), each with 34

plastic brackets. For efficient packing, the trolley is supplied disassembled.

**The test leads are not supplied!**

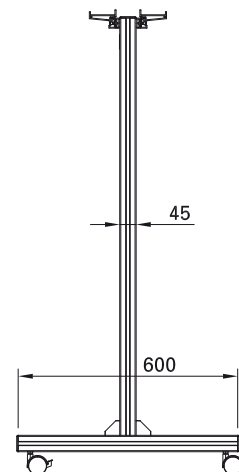
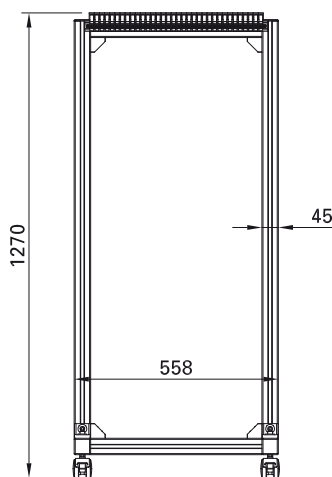
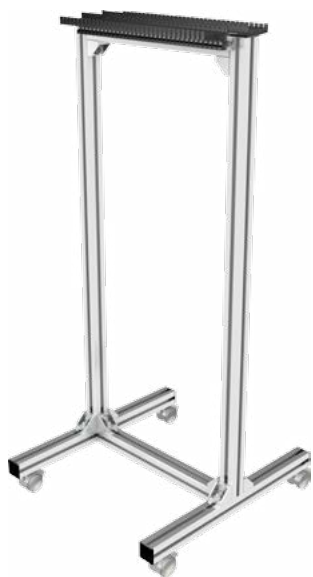

Order No.	Type
64.9284	LKW2-N

## Test Lead Holders MH-1/...

Holder for orderly storage of test leads. C-profile rails, made of anodized aluminum of different lengths (type MPS-...) can be used as a carrier for hanger modules MPK-

10. Integral spacers maintain a set spacing of 4 mm. When necessary, the spacers can be taken away easily to storage leads with smaller diameters. For thicker leads, the

holders can be moved accordingly in the C-profile rail.

MH-1...



MPS-...



Order No.	Type	Length	Number of hangers
64.9242-020	MH-1/200	20 cm	12
64.9243-025	MH-1/250	25 cm	16
64.9244-033	MH-1/330	33 cm	21
64.9245-050	MH-1/500	50 cm	34
64.9246-075	MH-1/750	75 cm	52
64.9247-100	MH-1/1000	100 cm	69

### Component parts

64.9235	MPK-10	Hanger module
64.9236-020	MPS-200	C-profile rail suitable for: MH-1/200
64.9237-025	MPS-250	C-profile rail suitable for: MH-1/250
64.9238-033	MPS-330	C-profile rail suitable for: MH-1/330
64.9239-050	MPS-500	C-profile rail suitable for: MH-1/500
64.9240-075	MPS-750	C-profile rail suitable for: MH-1/750
64.9241-100	MPS-1000	C-profile rail suitable for: MH-1/1000

## APPENDIX

# Product range consolidation/Alternative article

If you were unable to find the items you were looking for in this catalog, they may be listed here. In the following list, you can see whether the item you were looking for has been affected by the overhaul to our

portfolio, and whether any recommended alternatives are available. Please note that we cannot offer alternatives for every discontinued item. The suggested alternative items are not always 1:1 replacements and

could differ slightly from the original items. For this reason it is imperative that you refer to the properties of the alternative item on the corresponding catalog page.

### Sorted by type

Phased-out article		Alternative article		
Type	Order No.	Type	Order No.	Page
A-2/2	24.0114-*			
A-CEE/SLK4	50.4800			
AK0,63-B/405-BK	28.0005-01521			
AK1-A/4012-BK	28.0007-015*			
AK1-B/1-S	28.0008-*			
AK2-F/4-B	28.0010-*	AK205/410	28.0011-*	32
ALH-200	64.9350-*			
A-NETZ/SLK4-B	24.0147-28			
AS-2/4	64.9227-*	XA-2/4	65.9192-*	2)
AZ4/4-2	22.3000-*			
B4-E-IM5	23.5091			
B4-E-IM5-I	23.1036-*			
B-EB4-F	23.5042			
DLH-200	64.9382-090			
EB4-F	23.1023-*			
FSL	64.7290-*	LK425-A/X	28.0119-*	35
GMF-438	64.9710-*			
GMS-438	64.9711-*			
I-KK2/2	24.5090-*			
KK2/4	24.0141-*			
KP4-2P/19	24.0103-*			
KS2-19L	24.0044-29			
KS2-5,08L/1	24.0046-29	KS2-5,08L	24.0040-29	29
KS4-14L/A	20.1005-28			
KS4-14L/N	20.1000-28			
KT1-A	22.2040-*			
KT2,3-F90	22.2100-*			
KT415	22.2150-*			
KT415-L	22.2180-*			
KT-471	64.1010-*			
KT4-A	22.2050-*	KT4-B	22.2060-*	38
L-471	64.9204-*	SLS425-A/X	22.2634-*	40
LB2-D/N	49.7511	LB2-D	49.7512	21
LK1,25-B	28.0023-*			

Phased-out article		Alternative article		
Type	Order No.	Type	Order No.	Page
LK205/SIL	28.0040-*	LK205	28.0039-*	14
LK205-A	28.0041-*	LK205	28.0039-*	14
LK205-B	28.0043-*			
LK205-B/SIL	28.0044-*			
LK205-BF	28.0045-*			
LK205-BF/SIL	28.0046-*			
LK205-S	28.0048-*	LK205-L	28.0047-*	15
LK205-S/SIL	28.0049-*	LK205-L	28.0047-*	15
LK205-U	28.0050-*			
LK205-U/SIL	28.0051-*			
LK2-S	28.0037-*			
LK410-L/SIL	28.0066-*	LK410-L	28.0065-*	36
LK415	28.0068-*	LK425-A	28.0073-*	35
LK415-B	28.0069-*	LK425-B	28.0077-*	37
LK425-ZL	49.0112-*			
LK4-A	28.0053-*	LK4-B	28.0055-*	34
LKW2	25.0010	LKW2-N	64.9284-	75
LS0,63-0,78-B-I	49.7001-21			
LS1,62-S	22.5102			
LS1-A	22.1019			
LS2,3-F	22.1003			
LS2-F/N	22.5071	LS2-F	22.1006	16
LS2-S/A	22.5103	LS2-S	22.1002	17
LS305-L	22.5108			
LS410-TS	22.1013			
LS425	22.1000			
LS-471	64.1011			
LS4-E	22.1200	LS4	22.1005	38
LS4-E/N	22.1201	LS4	22.1005	38
LS4N	22.5068	LS4	22.1005	38
MB0,76	25.0029			
MB4-ESD	25.0034			
MICROGRIP-A	63.9090-*	KPS1	24.0135-*	13
MICROGRIP-XB0,63	68.9059-*			
MINI-STRIPAX	25.0014			
MINI-STRIPAX/M	25.5014			
PA2-5x0,65/B4	24.0522-21			
PA2-8x0,8/B4	24.0523-21			
PK4-T/A	23.0360-*	PK4-T	23.0330-*	58
PK4-TS	23.0350-*			
PKUI-35	64.9214-*			
PP1	24.0229-*			

<sup>1)</sup> see catalog „Test Accessories Touch-Protected“, page 19

Phased-out article		Alternative article		
Type	Order No.	Type	Order No.	Page
PPK1	28.0082-045*			
R4/2-F	24.0107	R4/2	24.0110	64
RS-4/2A	63.9226*	A2/4	24.0115-*	32
SAL	64.9291-*	FAL	64.9289-*	36
S-KS2-10L	24.5045	KS2-10L/1	24.0043-29	29
S-KS2-5,08L	24.5042	KS2-5,08L	24.0040-29	29
S-KS4-19L	24.5052			
SLS0,63-0,78-B-I	22.2601-21			
SLS1,62-S	22.2607-*			
SLS1-A	22.2604-*			
SLS2,3-F90	22.2624-*			
SLS2-F/N	22.2612-*	SLS2-F	22.2611-*	16
SLS2-S/A	22.2610-*	SLS2-S	22.2609-*	17
SLS305-L	22.2625-*			
SLS410-TS	22.2635-*			
SLS410-X	22.2630-*	SLS410N	22.2627-*	39
SLS415	22.2628-*	SLS425-A	22.2631-*	39
SLS415-B	22.2650-*	SLS425-B	22.2651-*	45
SLS415-L	22.2647-*	SLS425-L	22.2648-*	41
SLS415N	22.2629-*	SLS425-A/N	22.2632-*	39
SLS425-A/TS	22.2636-*			
SLS4-A	22.2638-*	SLS4-B	22.2642-*	38
SLS4-A/E	22.2640-*	SLS4-B	22.2642-*	38
SLS4-A/E/N	22.2641-*	SLS4-B	22.2642-*	38
SLS4-A/N	22.2639-*	SLS4-B	22.2642-*	38
SLS4-B/E	22.2644-*	SLS4-B	22.2642-*	38
SLS4-B/E/N	22.2645-*	SLS4-B	22.2642-*	38
SLS4-B/N	22.2643-*	SLS4-B	22.2642-*	38
SSL	64.7291-*	LK425-A/X	28.0119-*	35
STS1,5-I	25.0037			
VS4-38	24.0026-21			
XAKK-446	66.9399-150			
XUG	66.9122-*	LS410-I	22.5163-*	65
ZG410	64.9307-*	XZG410	66.9405-*	1)
ZG410/SIL	64.9308-*	XZG410/SIL	66.9406-*	1)
ZG425	64.9309-*	XZG425	66.9407-*	1)
ZG425/SIL	64.9310-*	XZG425/SIL	66.9408-*	1)

<sup>2)</sup> see catalog „Test Accessories Touch-Protected“, page 72

## Sorted by order No.

Phased-out article		Alternative article		
Order No.	Type	Order No.	Type	Page
20.1000-28	KS4-14L/N			
20.1005-28	KS4-14L/A			
22.1000	LS425			
22.1003	LS2,3-F			
22.1013	LS410-TS			
22.1019	LS1-A			
22.1200	LS4-E	22.1005	LS4	38
22.1201	LS4-E/N	22.1005	LS4	38
22.2040-*	KT1-A			
22.2050-*	KT4-A	22.2060-*	KT4-B	38
22.2100-*	KT2,3-F90			
22.2150-*	KT415			
22.2180-*	KT415-L			
22.2601-21	SLS0,63-0,78-B-I			
22.2604-*	SLS1-A			
22.2607-*	SLS1,62-S			
22.2610-*	SLS2-S/A	22.2609-*	SLS2-S	17
22.2612-*	SLS2-F/N	22.2611-*	SLS2-F	16
22.2624-*	SLS2,3-F90			
22.2625-*	SLS305-L			
22.2628-*	SLS415	22.2631-*	SLS425-A	39
22.2629-*	SLS415N	22.2632-*	SLS425-A/N	39
22.2630-*	SLS410-X	22.2627-*	SLS410N	39
22.2635-*	SLS410-TS			
22.2636-*	SLS425-A/TS			
22.2638-*	SLS4-A	22.2642-*	SLS4-B	38
22.2639-*	SLS4-A/N	22.2642-*	SLS4-B	38
22.2640-*	SLS4-A/E	22.2642-*	SLS4-B	38
22.2641-*	SLS4-A/E/N	22.2642-*	SLS4-B	38
22.2643-*	SLS4-B/N	22.2642-*	SLS4-B	38
22.2644-*	SLS4-B/E	22.2642-*	SLS4-B	38
22.2645-*	SLS4-B/E/N	22.2642-*	SLS4-B	38
22.2647-*	SLS415-L	22.2648-*	SLS425-L	41
22.2650-*	SLS415-B	22.2651-*	SLS425-B	45
22.3000-*	AZ4/4-2			
22.5068	LS4N	22.1005	LS4	38
22.5071	LS2-F/N	22.1006	LS2-F	16
22.5102	LS1,62-S			
22.5103	LS2-S/A	22.1002	LS2-S	17
22.5108	LS305-L			



Phased-out article		Alternative article		
Order No.	Type	Order No.	Type	Page
23.0350-*	PK4-TS			
23.0360-*	PK4-T/A	23.0330-*	PK4-T	58
23.1023-*	EB4-F			
23.1036-*	B4-E-IM5-I			
23.5042	B-EB4-F			
23.5091	B4-E-IM5			
24.0026-21	VS4-38			
24.0044-29	KS2-19L			
24.0046-29	KS2-5,08L/1	24.0040-29	KS2-5,08L	29
24.0103-*	KP4-2P/19			
24.0107	R4/2-F	24.0110	R4/2	64
24.0114-*	A-2/2			
24.0141-*	KK2/4			
24.0147-28	A-NETZ/SLK4-B			
24.0229-*	PP1			
24.0522-21	PA2-5x0,65/B4			
24.0523-21	PA2-8x0,8/B4			
24.5042	S-KS2-5,08L	24.0040-29	KS2-5,08L	29
24.5045	S-KS2-10L	24.0043-29	KS2-10L/1	29
24.5052	S-KS4-19L			
24.5090-*	I-KK2/2			
25.0010	LKW2	64.9284-	LKW2-N	75
25.0014	MINI-STRIPAX			
25.0029	MB0,76			
25.0034	MB4-ESD			
25.0037	STS1,5-I			
25.5014	MINI-STRIPAX/M			
28.0005-01521	AK0,63-B/405-BK			
28.0007-015*	AK1-A/4012-BK			
28.0008-*	AK1-B/1-S			
28.0010-*	AK2-F/4-B	28.0011-*	AK205/410	32
28.0023-*	LK1,25-B			
28.0037-*	LK2-S			
28.0040-*	LK205/SIL	28.0039-*	LK205	14
28.0041-*	LK205-A	28.0039-*	LK205	14
28.0043-*	LK205-B			
28.0044-*	LK205-B/SIL			
28.0045-*	LK205-BF			
28.0046-*	LK205-BF/SIL			
28.0048-*	LK205-S	28.0047-*	LK205-L	15
28.0049-*	LK205-S/SIL	28.0047-*	LK205-L	15
28.0050-*	LK205-U			

Phased-out article		Alternative article		
Order No.	Type	Order No.	Type	Page
28.0051-*	LK205-U/SIL			
28.0053-*	LK4-A	28.0055-*	LK4-B	34
28.0066-*	LK410-L/SIL	28.0065-*	LK410-L	36
28.0068-*	LK415	28.0073-*	LK425-A	35
28.0069-*	LK415-B	28.0077-*	LK425-B	37
28.0082-045*	PPK1			
49.0112-*	LK425-ZL			
49.7001-21	LS0,63-0,78-B-I			
49.7511	LB2-D/N	49.7512	LB2-D	21
50.4800	A-CEE/SLK4			
63.9090-*	MICROGRIP-A	24.0135-*	KPS1	13
63.9226-*	RS-4/2A	24.0115-*	A2/4	32
64.1010-*	KT-471			
64.1011	LS-471			
64.7290-*	FSL	28.0119-*	LK425-A/X	35
64.7291-*	SSL	28.0119-*	LK425-A/X	35
64.9204-*	L-471	22.2634-*	SLS425-A/X	40
64.9214-*	PKUI-35			
64.9227-*	AS-2/4	65.9192-*	XA-2/4	2)
64.9291-*	SAL	64.9289-*	FAL	36
64.9307-*	ZG410	66.9405-*	XZG410	1)
64.9308-*	ZG410/SIL	66.9406-*	XZG410/SIL	1)
64.9309-*	ZG425	66.9407-*	XZG425	1)
64.9310-*	ZG425/SIL	66.9408-*	XZG425/SIL	1)
64.9350-*	ALH-200			
64.9382-090	DLH-200			
64.9710-*	GMF-438			
64.9711-*	GMS-438			
66.9122-*	XUG	22.5163-*	LS410-I	65
66.9399-150	XAKK-446			
68.9059-*	MICROGRIP-XB0,63			

<sup>1)</sup> see catalog „Test Accessories Touch-Protected“, page 19

<sup>2)</sup> see catalog „Test Accessories Touch-Protected“, page 72

# Index

Type	Page
A2/4	32
A4/4-Z	65
AGK20	60
AGK40	28
AK205/405-BK	33
AK205/410	32
AK410-L/B	37
APK-4	60
A-SLK4-RG	67
B4-E-M5	66
B4-E-M5-I	66
B-EB2	22
B-EB2-A	22
B-EB2-F	23
B-EB4	47
B-EB4-A	48
B-EB4-A/N	48
B-EB4-B	49
B-EB4-C	50
BI-LB2-IF	24
BI-LB4-R/I	52
BI-LB-I2R	24
BI-LB-I4/2P	58
BI-LB-I4Q	54
BI-LB-I4R	53
BI-LB-I4R-A	55
BI-LB-I4R-B	54
BI-LB-IF2R	25
BI-LB-IF4R	57
BI-LB-IF4R-A	56
BL2-6/20-0,65	26
BL2-6/20/A	26
BL2-12/20-0,65	26
BL2-12/20/A	26
B-LB4-R	51
B-LB4-R/A	51
BST-45	67
EB0,76	12
EB1	12
EB2	22
EB2-A	22
EB2-F	23
EB4	47
EB4-A	48

Type	Page
EB4-A/N	48
EB4-B	49
EB4-C	50
EBI-40	52
EPB-2N/S	21
FAL	36
FML	34
FSH2,8x0,8	72
FSH4,8x0,8	72
FSH6,3x0,8	72
FS/M4	70
FS/M12	70
GEW.12-MUTTER	68
GL-438	44
GRIP-A	60
I-A2/4	66
ID-SAB4-G	71
I-EB1	12
I-EB2	22, 23
I-EB4	47, 48, 50
I-EB4-B	49
K-41	45
KLS4	46
KPS1	13
KPS1/B2	28
KS2-5,08L	29
KS2-5,08L/1A/A	30
KS2-5,08L/1A/N	30
KS2-6L/A	31
KS2-6L/N	31
KS2-10L	29
KS2-10L/1	29
KS2-12L/1SA/A	30
KS2-12L/1SA/N	30
KS2-12L/A	31
KS2-12L/N	31
KS4-11L/1A/A	61
KS4-11L/1A/N	61
KS4-14	62
KS4-14LA/A	61
KS4-14LA/N	61
KS4-19	62
KS4-19L	63
KS4-19L/1	63

Type	Page
KT0,76-S	10
KT1-S	10, 11
KT2-F	16
KT2-S	11, 12, 17, 19
KT4-B	38
KT205	16, 17
KT205-S	18, 19, 20
KT410	39
KT410-L	41, 45
KT425-A	39, 40
KT425-L	41, 45
KT425-ZL	44
L-41	43
L-41Q	43
L-400	42
L-409	42
LB0,76	12
LB1	12
LB2	20
LB2-A	21
LB2-D	21
LB2-IF	24
LB4	46
LB4-A	47
LB4N	46
LB4-R	51
LB4-R/A	51
LB4-R/I	52
LB-I2R	24
LB-I4/2P	58
LB-I4Q	54
LB-I4R	53
LB-I4R-A	55
LB-I4R-B	54
LB-IF2R	25
LB-IF4R	57
LB-IF4R-A	56
LK1-A	9
LK1-S	9
LK2-F	14
LK4-B	34
LK4-B/SIL	34
LK205	14
LK205-L	15

Type	Page
LK205-X	14
LK410	35
LK410-B	37
LK410-L	36
LK410/SIL	35
LK410-X	35
LK425-A	35
LK425-A/SIL	35
LK425-A/X	35
LK425-B	37
LKW2-N	75
LS0,76-S	10
LS1,5-S	12
LS1,25-B	11
LS1-B	11
LS1-S	10
LS2-F	16
LS2-S	17
LS4	38
LS205	17
LS205-A	16
LS205-B	19
LS205-BF	20
LS205-L	19
LS205-L/N	19
LS205N	17
LS205-S	18
LS205-U	18
LS410	39
LS410-B	45
LS410-I	65
LS410-L	41
LS410N	39
LS410-X	40
LS425-AM	40
LS425-B	45
LS425-L	41
LS425-ZL	44
LS425-ZL/M3	44
MB1	73
MB2	73
MB2-S	73
MB4	73
MB4-S	73

Type	Page
MH-1/200	76
MH-1/250	76
MH-1/330	76
MH-1/500	76
MH-1/750	76
MH-1/1000	76
MPK-10	76
MPS-200	76
MPS-250	76
MPS-330	76
MPS-500	76
MPS-750	76
MPS-1000	76
MSLB4-G	51
MU0,5D/M4N	68
MU0,8D/M4	68
MU0,8D/M4N	68
MUE/M6x0,75	68
MU/M5	68
MU/M6x0,5	68
MU/M8x0,5	68
MU/M12x0,75	68
MUR/M6x0,5	69
MUR/M8x0,5	69
MUR/M12x0,75	69
MUR-S/M12x0,75	69
PK2-T	25
PK4-T	58
PP-130	59
PS2,3	66
PZK3	74
R4/2	64
R4/2-A	64
SCHUDE-SLB	70
SCHUKA-SLB	71
SD-XUB	70
SKPS-4	59
SLS0,76-S	10
SLS1,5-S	12
SLS1,25-B	11
SLS1-B	11
SLS1-S	10
SLS2-F	16
SLS2-S	17

Type	Page
SLS4-B	38
SLS205	17
SLS205-A	16
SLS205-B	19
SLS205-BF	20
SLS205-L	19
SLS205-L/N	19
SLS205-S	18
SLS205-U	18
SLS205-X	17
SLS410	39
SLS410-B	45
SLS410-L	41
SLS410N	39
SLS425-A	39
SLS425-AM	40
SLS425-A/N	39
SLS425-A/X	40
SLS425-B	45
SLS425-L	41
SLS425-ZL	44
SLS425-ZL/M3	44
SML	34
SP2	69
SP4	69
SPP2-S	27
SS2	72
SS2-S	72
SS4	72
SS6	72
SS425	72
SSP4	69
STRIPAX	74
STRIPAX/M	74
STS1,5	73
U/4,3x12	69
U/M4	69
XAS-1R	71
ZGL-410	41
ZGL-425	41

# Notes

# Notes



■ Stäubli Units    ○ Agents

# Global presence of the Stäubli Group

[www.staubli.com/contacts](http://www.staubli.com/contacts)