

# Oscilloscope Probes and Probe Accessories

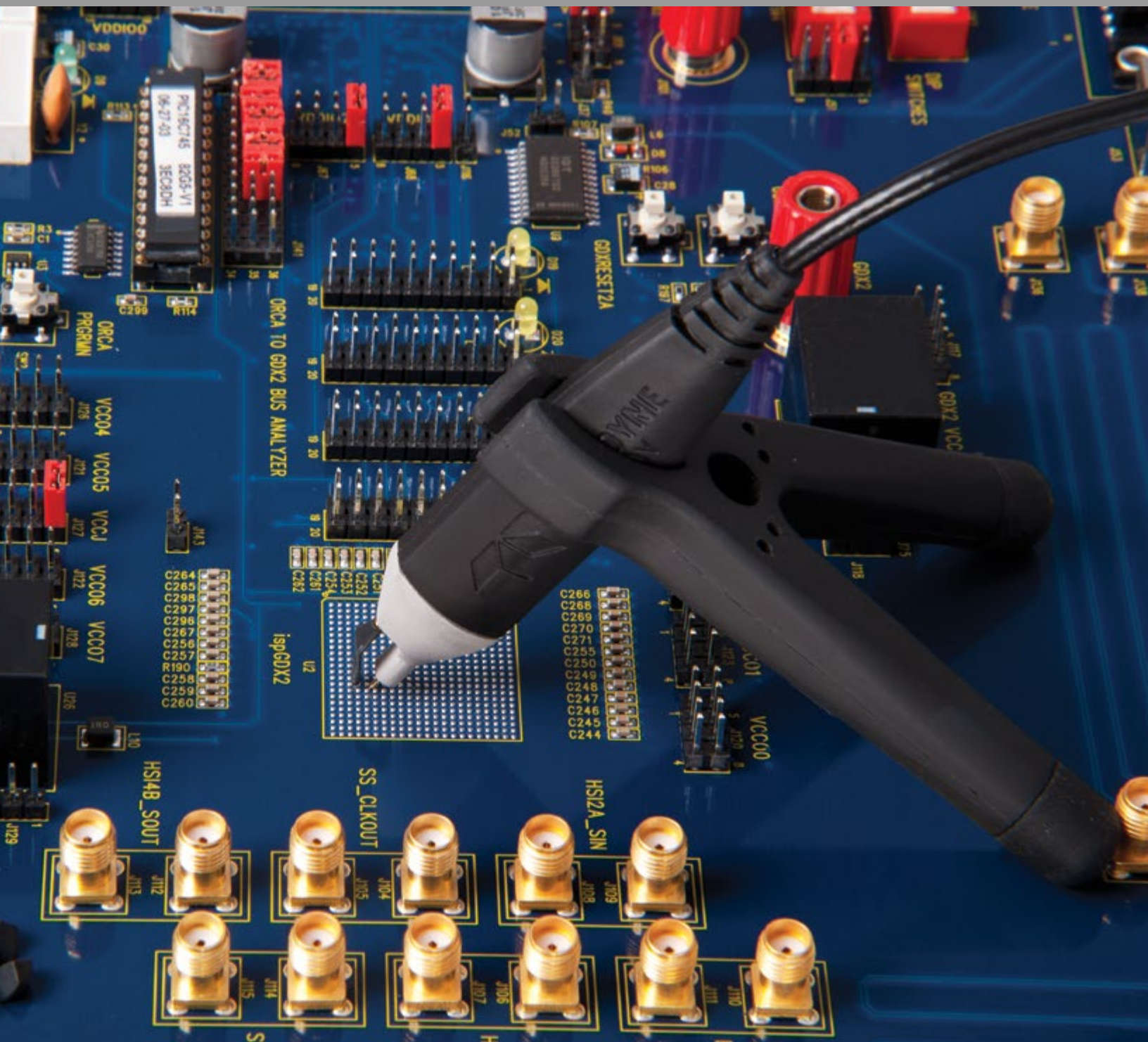

Teledyne LeCroy has a wide variety of world class probes and amplifiers to compliment its product line. From the ZS high impedance active probes to the WaveLink differential probing system which offers bandwidths up to 25 GHz, Teledyne LeCroy probes and probe accessories provide optimum mechanical connections for signal measurement.



Front Cover:  
ZS Series High Impedance  
Active Probes

	WaveAce Oscilloscopes	WaveJet Oscilloscopes	WaveSurfer 3000 Oscilloscopes	WaveSurfer 10 / MXs-B / MSO MXs-B Oscilloscopes	HDO4000 / HDO4000-MS High Definition Oscilloscopes	HDO6000 / HDO6000-MS High Definition Oscilloscopes	WaveRunner 8000 Oscilloscopes	HDO8000 / HDO8000-MS High Definition Oscilloscopes	MDA800 Motor Drive Analyzers	HDO9000 / HDO9000-MS High Definition Oscilloscopes	WavePro/SDA/DDA/7 Zi/7 Zi-A Oscilloscopes	WaveMaster/SDA/DDA/8 Zi/Zi-B Oscilloscopes	LabMaster 9 Zi-A Oscilloscopes	LabMaster 10 Zi-A Oscilloscopes
<b>Active Voltage Rail Probes - p. 4 - 7</b>														
RP4030				✓	✓	✓	✓	✓	✓	✓	✓	✓	✓	✓
<b>Active Voltage Probes - p. 8 - 11</b>														
ZS1000	✓	✓	✓	✓	✓	✓	✓	✓	✓	✓	✓	✓	✓	✓
ZS1500		✓	✓	✓	✓	✓	✓	✓	✓	✓	✓	✓	✓	✓
ZS2500						✓			✓	✓	✓	✓	✓	✓
ZS4000						✓			✓	✓	✓	✓	✓	✓
<b>Current Probes - p. 12 - 15</b>														
CP030	✓	✓	✓	✓	✓	✓	✓	✓	✓	✓	✓	✓	✓	✓
CP030A	✓	✓	✓	✓	✓	✓	✓	✓	✓	✓	✓	✓	✓	✓
CP031	✓	✓	✓	✓	✓	✓	✓	✓	✓	✓	✓	✓	✓	✓
CP031A	✓	✓	✓	✓	✓	✓	✓	✓	✓	✓	✓	✓	✓	✓
CP150	✓	✓	✓	✓	✓	✓	✓	✓	✓	✓	✓	✓	✓	✓
CP500	✓	✓	✓	✓	✓	✓	✓	✓	✓	✓	✓	✓	✓	✓
CA10			✓	✓	✓	✓	✓	✓	✓	✓	✓	✓	✓	✓
<b>Differential Probes - p. 16 - 25</b>														
ZD200	✓	✓	✓	✓	✓	✓	✓	✓	✓	✓	✓	✓	✓	✓
ZD500	✓	✓	✓	✓	✓	✓	✓	✓	✓	✓	✓	✓	✓	✓
ZD1000	✓	✓	✓	✓	✓	✓	✓	✓	✓	✓	✓	✓	✓	✓
ZD1500	✓	✓	✓	✓	✓	✓	✓	✓	✓	✓	✓	✓	✓	✓
AP033	✓	✓	✓	✓	✓	✓	✓	✓	✓	✓	✓	✓	✓	✓
D410-A-PS						✓			✓	✓	✓	✓	✓	✓
D420-A-PS						✓			✓	✓	✓	✓	✓	✓
D400A-AT						✓			✓	✓	✓	✓	✓	✓
D610-A-PS						✓			✓	✓	✓	✓	✓	✓
D620-A-PS						✓			✓	✓	✓	✓	✓	✓
D600A-AT						✓			✓	✓	✓	✓	✓	✓
D830-PS											✓	✓	✓	✓
D1030-PS											✓	✓	✓	✓
D1330-PS											✓	✓	✓	✓
D1305-A-PS											✓	✓	✓	✓
D1605-A-PS											✓	✓	✓	✓
D2005-A-PS											✓	✓	✓	✓
D2505-A-PS											✓	✓	✓	✓
<b>High Voltage Differential Probes - p. 26 - 31</b>														
HVD3102	✓	✓	✓	✓	✓	✓	✓	✓	✓	✓	✓	✓	✓	✓
HVD3106	✓	✓	✓	✓	✓	✓	✓	✓	✓	✓	✓	✓	✓	✓
HVD3106-6M	✓	✓	✓	✓	✓	✓	✓	✓	✓	✓	✓	✓	✓	✓
HVD3206	✓	✓	✓	✓	✓	✓	✓	✓	✓	✓	✓	✓	✓	✓
HVD3206-6M	✓	✓	✓	✓	✓	✓	✓	✓	✓	✓	✓	✓	✓	✓
HVD3605	✓	✓	✓	✓	✓	✓	✓	✓	✓	✓	✓	✓	✓	✓

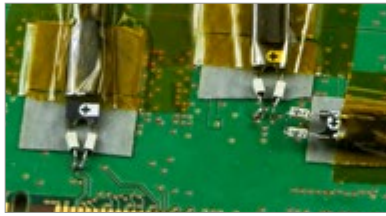
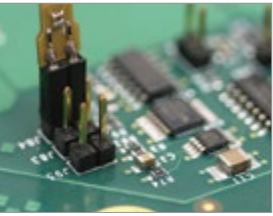

*WaveAce Oscilloscopes*  
*WaveJet Oscilloscopes*  
*WaveSurfer 3000 Oscilloscopes*  
*WaveSurfer 10 / MXs-B / MSO MXs-B Oscilloscopes*  
*HDO4000 / HDO4000-MS High Definition Oscilloscopes*  
*HDO6000 / HDO6000-MS High Definition Oscilloscopes*  
*WaveRunner 8000 Oscilloscopes*  
*HDO8000 / HDO8000-MS High Definition Oscilloscopes*  
*MDA800 Motor Drive Analyzers*  
*HDO9000 / HDO9000-MS High Definition Oscilloscopes*  
*WavePro/SDA/DDA/7 Zi/7 Zi-A Oscilloscopes*  
*WaveMaster/SDA/DDA/8 Zi/8 Zi-B Oscilloscopes*  
*LabMaster 9 Zi-A Oscilloscopes*  
*LabMaster 10 Zi-A Oscilloscopes*

High Voltage Differential Probes (cont'd) - p. 26-31													
ADP300													
ADP305													
AP031	✓	✓	✓	✓	✓	✓	✓	✓	✓	✓	✓	✓	✓
Differential Amplifiers - p. 32 - 35													
DXC200			✓	✓	✓	✓	✓	✓	✓	✓	✓	✓	✓
DA101			✓	✓	✓	✓	✓	✓	✓	✓	✓	✓	✓
DA1855A			✓	✓	✓	✓	✓	✓	✓	✓	✓	✓	✓
DA1855A-PR2			✓	✓	✓	✓	✓	✓	✓	✓	✓	✓	✓
DA1855A-PR2-RM			✓	✓	✓	✓	✓	✓	✓	✓	✓	✓	✓
DA1855A-RM			✓	✓	✓	✓	✓	✓	✓	✓	✓	✓	✓
DXC-5100			✓	✓	✓	✓	✓	✓	✓	✓	✓	✓	✓
DXC100A			✓	✓	✓	✓	✓	✓	✓	✓	✓	✓	✓
High Voltage Probes - p. 36 - 39													
HVP120	✓	✓	✓	✓	✓	✓	✓	✓	✓	✓	✓	✓	✓
PPE4KV	✓	✓	✓	✓	✓	✓	✓	✓	✓	✓	✓	✓	✓
PPE5KV	✓	✓	✓	✓	✓	✓	✓	✓	✓	✓	✓	✓	✓
PPE6KV	✓	✓	✓	✓	✓	✓	✓	✓	✓	✓	✓	✓	✓
High Voltage Fiber Optically-isolated Probes - p. 40 - 43													
HVFO103					✓	✓	✓	✓	✓	✓	✓	✓	✓
Optical-To-Electrical Converters - p. 44 - 47													
OE6250G-M													
OE695G											✓	✓	✓
OE425							✓			✓	✓	✓	✓
OE455							✓			✓	✓	✓	✓
OE525										✓	✓	✓	✓
OE555										✓	✓	✓	✓
Passive Probes - p. 48 - 51													
PP006C		✓											
PP016	✓												
PP019			✓										
PP020			✓										
PP021				✓						✓	✓		
PP022				✓			✓			✓			
PP023					✓		✓	✓		✓			
PP024				✓			✓			✓			
PP025				✓						✓	✓		
PP026					✓	✓		✓	✓				
Probe Adapters - p. 52 - 53													
CA10					✓	✓	✓	✓	✓	✓	✓	✓	✓
TPA10		✓	✓	✓	✓	✓	✓	✓	✓	✓	✓	✓	✓
Transmission Line Probes - p. 54 - 55													
PP066										✓	✓	✓	✓

Note: Some probes require purchase of the amplifier and platform/cable assembly separately – Reference detailed literature for more information.

# ACTIVE VOLTAGE RAIL PROBE

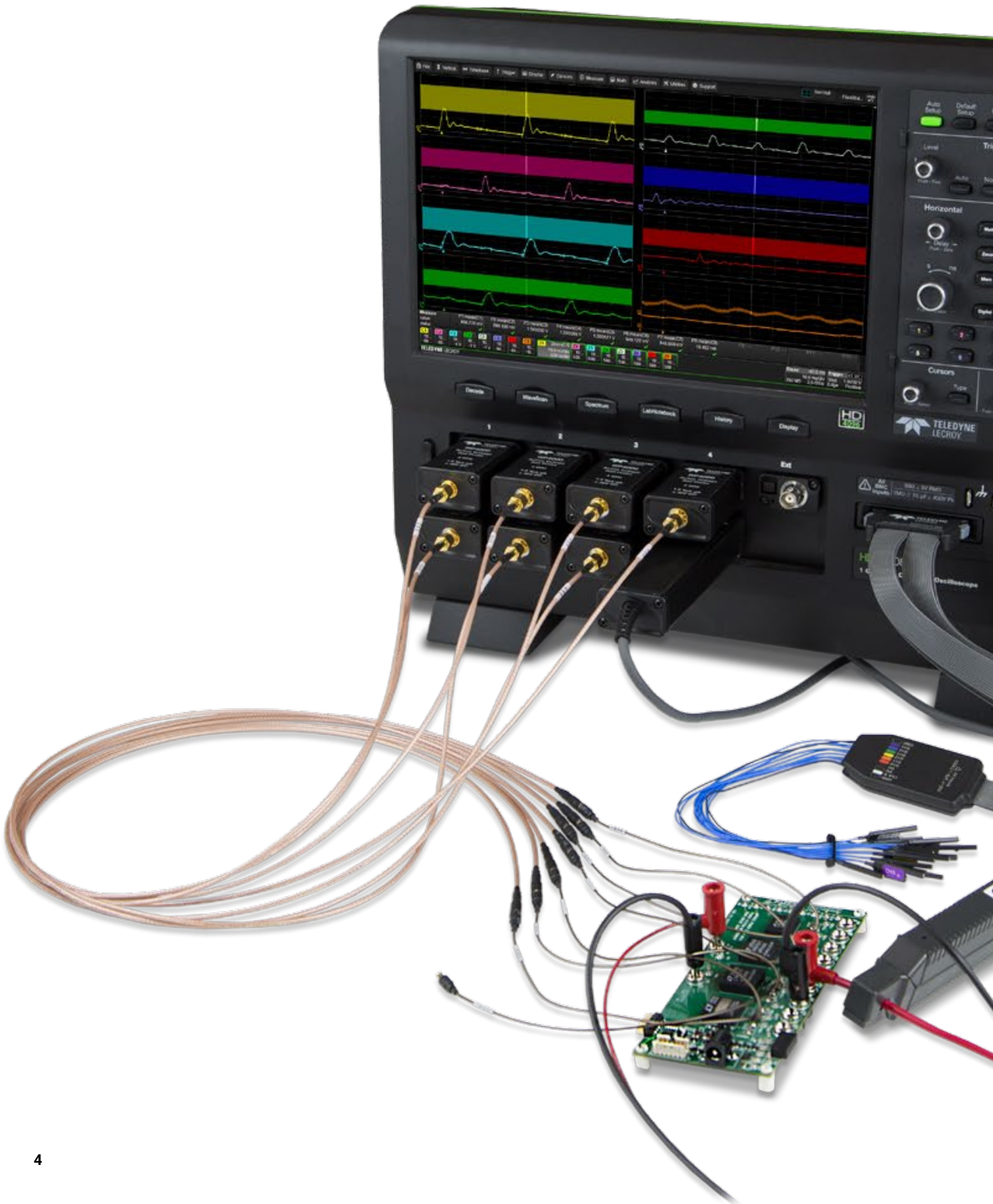

The RP4030 is designed specifically to probe a 50Ω DC power/voltage rail. The probe has large built-in offset, low attenuation (noise), and high DC input impedance. Built-in offset and low attenuation permit the power/voltage rail to be offset in the oscilloscope by its mean DC voltage with high oscilloscope gain (sensitivity) to achieve a noise-free view of small signal variations. The high DC input impedance eliminates loading of the DC rail.

Teledyne LeCroy  
Active Voltage Rail Probe  
Model Numbers:  
**RP4030**

*Opposite page:  
Active Voltage Rail Probes RP4030 working with  
an HD08000 High Definition Oscilloscope*

# ACTIVE VOLTAGE RAIL PROBE

Teledyne LeCroy  
Active Voltage Rail Probe  
Model Number:  
RP4030

## Key Features

**4 GHz Bandwidth**

**±30V Offset Capability**

**±800mV Dynamic Range**

**50 kΩ DC Input Impedance**

**1.2x Attenuation (Low Additive Noise, ~5%)**

**MCX terminated cable with wide variety of connections:**

- Solder-in (4 GHz)
- Coaxial Cable to U.FL receptacle (3 GHz)
- MCX PCB Mount (4 GHz)
- Browser (350 MHz)

**ProBus Interface**



## Large Offset Range

Permits the DC signal to be displayed in the vertical center of the oscilloscope grid with a high-sensitivity gain setting.

## Low Attenuation and Noise

The probe attenuation is a nominal 1.2x coupled to the oscilloscope at DC 50 Ω. This keeps additive noise to a minimum, and makes it exceptionally useful with High Definition oscilloscopes for lowest noise at highest sensitivity gain settings.

## High DC Input Impedance

50 kΩ input impedance at DC effectively eliminates probe loading on the DC power/voltage rail and provides for more accurate measurements and signal fidelity.

## 4 GHz of Bandwidth

Provides maximum bandwidth for probing near the CPU, and the perfect match with the 4 GHz, 10 bit HDO9404 when making power integrity measurements.

## Wide Assortment of Tips and Leads

The RP4030 is supplied standard with solder-in and coaxial cables with MCX and U.FL PCB receptacle mounts. A browser tip is optionally available. Additional receptacles or leads may be purchased as accessories and left connected in circuit for easy connection of different signals during different test or validation stages.

## Specifications

### Electrical Characteristics

Bandwidth	4 GHz (guaranteed, MCX receptacle) 4 GHz (typical, solder-in lead) 3 GHz (typical, U.FL cable + receptacle) 350 MHz (typical, browser)
Rise Time (10-90%)	110 ps (typical, MCX receptacle or solder-in lead)
Input Capacitance	0.1 uF (in series with 50Ω)
DC Input Resistance	50 kΩ
Offset Range	±30V
Attenuation	1.2x
Input Dynamic Range	±800 mV
Non-destruct Voltage	±50V
Noise	~5% additive to oscilloscope noise
Oscilloscope Termination	DC 50Ω

### Environmental

Operating Temperature Range	0 to 50 °C
Non-operating Temperature Range	-40 to +70 °C
Humidity	5% to 80% RH (non-condensing) up to 30 °C, decreasing linearly to to 45% RH at 50 °C
Operating Altitude	3000 meters maximum

### Physical

RP4030	<b>Probe:</b> 38.1 mm W x 15.9mm H x 73mm L (1-1/2" x 5/8" x 2-7/8") <b>SMA to MCX Cable:</b> 914mm L (36") <b>MCX to Solder-in Lead:</b> 191mm (7-1/2") usable length <b>MCX to U.FL Plug Coaxial Cable:</b> 102mm (4") usable length
RP4000-BROWSER	11.9mm W x 9.5mm H x 38mm L (15/32" x 3/8" x 1-1/2") <b>SMA to SMA Cable:</b> 1m (39-3/8") usable length

### Other

Oscilloscope Interface	Teledyne LeCroy ProBus
Software Requirements	Teledyne LeCroy MAUI 8.2.1.1 or higher
Weight	119 g (0.26 lb)

## Ordering Information

### Product Description

Power/Voltage Rail Probe  
4 GHz, 1.2x, ±30V offset, ±800mV dynamic range

### Product Code

RP4030

Includes Qty. 1 ProBus compatible probe offset amplifier with 50 kΩ DC input impedance and SMA input connection for provided 0.9m SMA to MCX extension cable. Also supplied are Qty. 3 MCX solder-in leads, Qty. 3 MCX PCB Mounts, Qty. 3 MCX to U.FL coaxial cables, Qty. 5 U.FL PCB Mounts, Qty. 1 MCX to SMA adapter, and soft carrying case. Browser tip sold separately.

350 MHz Browser Tip Accessory

RP4000-BROWSER

Includes 0 Ω (1x), 450 Ω (10x) and 950 Ω (20x) tips.



### Accessories and Consumables

Qty. 3 MCX 4 GHz solder-in leads	RP4000-MCX-LEAD-SI
Qty. 10 MCX PCB mount receptacle	RP4000-MCX-PCBMOUNT
Qty. 3 MCX to U.FL 3 GHz ultra-mini coax cable	RP4000-MCX-CABLE-UFL
Qty. 10 U.FL PCB mount receptacles	RP4000-UFL-PCBMOUNT

# ACTIVE VOLTAGE PROBES

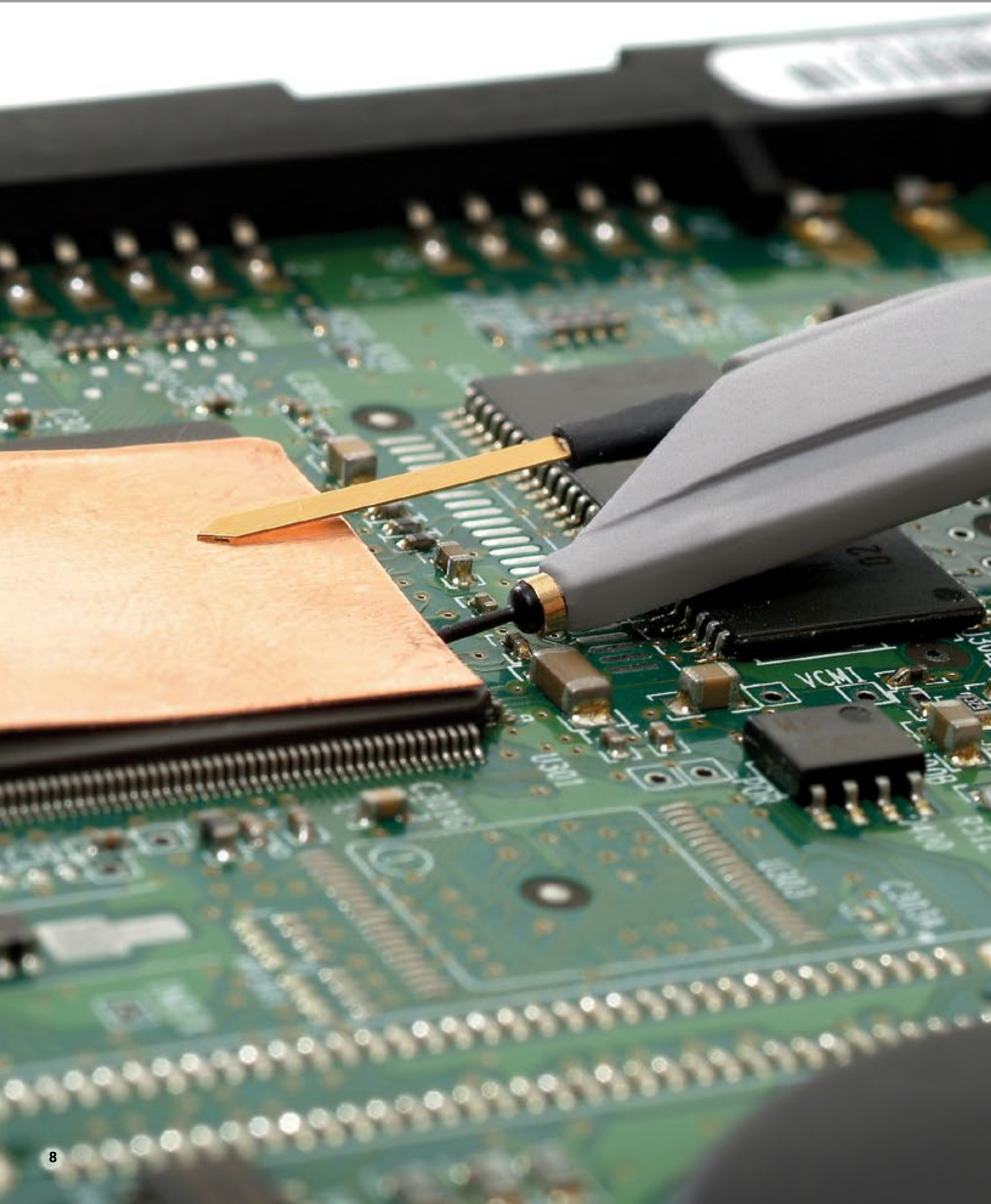



Engineers must commonly probe high-frequency signals with high signal fidelity. Typical passive probes with high input R and C provide good response at lower frequencies, but inappropriately load the circuit and distort signals at higher frequencies. Active voltage probes feature both high input R and low input C to reduce circuit loading across the entire probe/oscilloscope bandwidth. With low circuit loading and a form factor that allows probing in confined areas, the active voltage probe becomes the everyday probe for all different types of signals and connection points.

Teledyne LeCroy  
Active Voltage Probe  
Model Numbers:

ZS1000  
ZS1500  
ZS2500  
ZS4000

*Opposite page:  
ZS Series High Impedance Active Probe*

# ZS SERIES ACTIVE PROBES



Teledyne LeCroy  
Active Voltage Probe  
Model Numbers:

**ZS1000**  
**ZS1500**  
**ZS2500**  
**ZS4000**

The ZS Series probes are high impedance, low capacitance active probes that maintain high signal fidelity through 4 GHz. A small form factor and a wide variety of accessories ensures the ZS probe meets every difficult probing challenge.

Engineers must commonly probe high frequency signals with high signal fidelity. Typical passive probes with high input R and C provide good response at lower frequencies but inappropriately load the circuit and distort signals at higher frequencies. The ZS Series features both high input R (1 M $\Omega$ ) and low input C (0.6 pF and 0.9 pF) to reduce circuit loading across the entire probe/oscilloscope bandwidth. The ZS1000 is ideal for 200–600 MHz oscilloscopes. The ZS1500 is ideal for 1 GHz oscilloscopes, the ZS2500 is ideal for 2 GHz oscilloscopes, and the ZS4000 is ideal for 2.5 GHz and 4 GHz oscilloscopes.

## ZS4000

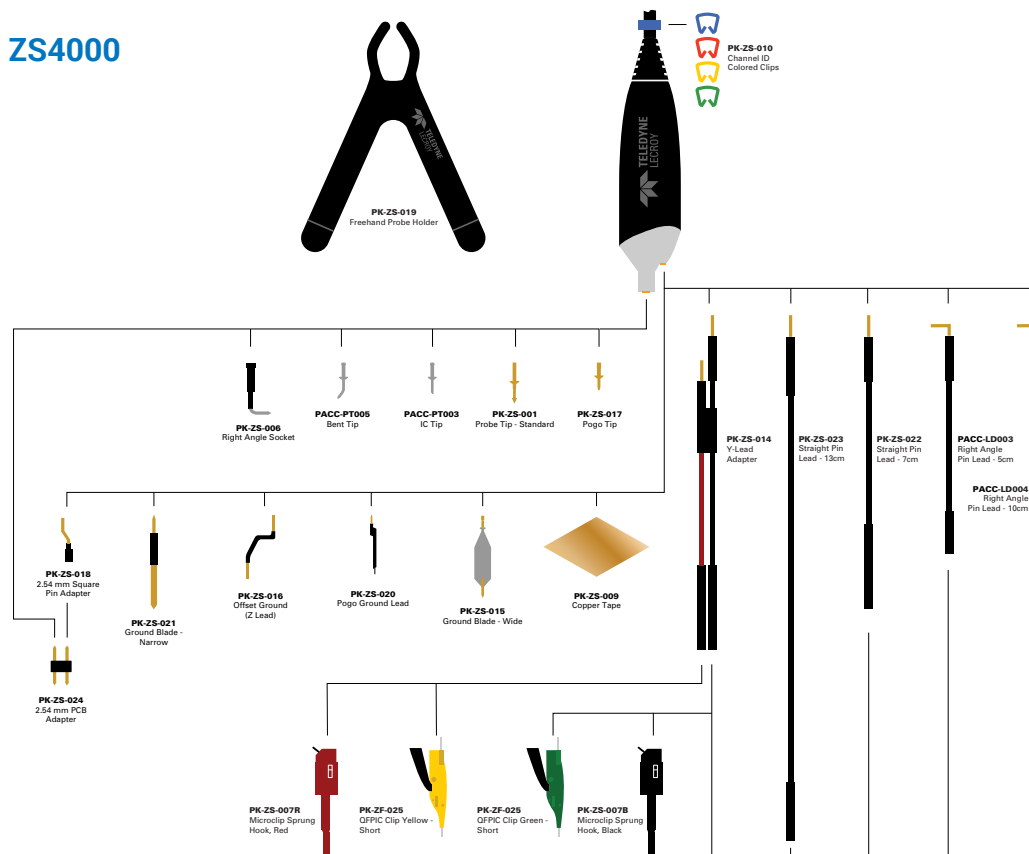

# ZS SERIES ACTIVE PROBES

ZS1000  
ZS1500  
ZS2500

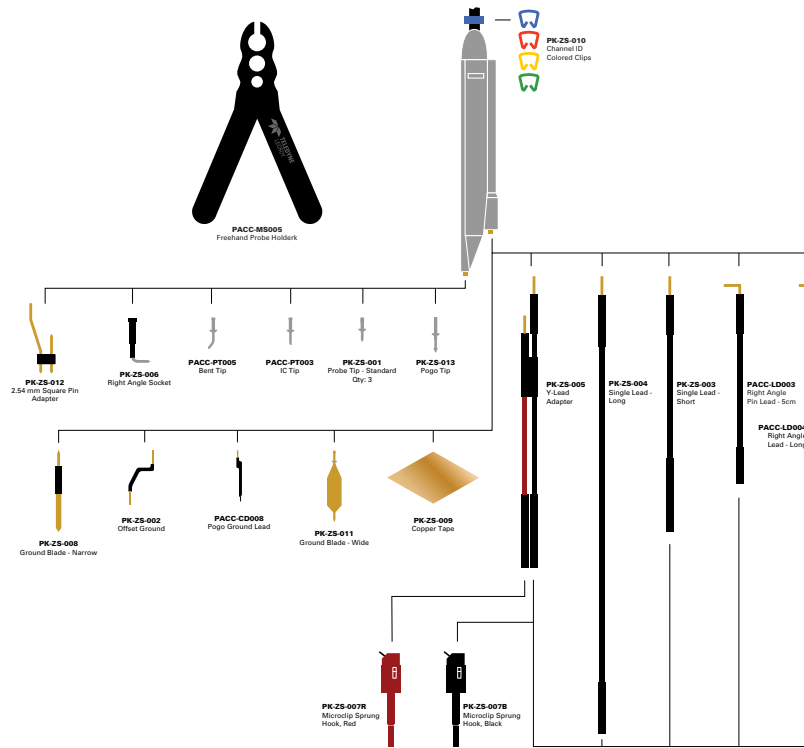

## Ordering Information

### Product Description

Product Description	Product Code
4 GHz, 0.6 pF, 1 M $\Omega$ High Impedance Active Probe	ZS4000
2.5 GHz, 0.9 pF, 1 M $\Omega$ High Impedance Active Probe	ZS2500
1.5 GHz, 0.9 pF, 1 M $\Omega$ High Impedance Active Probe	ZS1500
1 GHz, 0.9 pF, 1 M $\Omega$ High Impedance Active Probe	ZS1000
Set of 4 ZS2500, 2.5 GHz, 0.9 pF, 1 M $\Omega$ High Impedance Active Probes	ZS2500-QUADPAK
Set of 4 ZS1500, 1.5 GHz, 0.9 pF, 1 M $\Omega$ High Impedance Active Probes	ZS1500-QUADPAK
Set of 4 ZS1000, 1 GHz, 0.9 pF, 1 M $\Omega$ High Impedance Active Probes	ZS1000-QUADPAK

### Standard Accessory/Quantity

Accessory Description	Replacement Part Number	ZS1000	ZS1500	ZS2500	ZS4000
2.54 mm PCB Adaptor	PK-ZS-024				5
2.54mm Square Pin Adapter	PK-ZS-012	1			
2.54mm Square Pin Adaptor	PK-ZS-018		1		
IC Tip	PACC-PT003	1	1		
Bent Tip	PACC-PT005	1	1		
Channel ID Clips (Set of 4 colors)	PK-ZS-010	4	1		
Copper Tape Pad	PK-ZS-009	2	2		
Freehand Probe Holder	PK-ZS-019		1		
Freehand Probe Holder	PACC-MS005	1			
Ground Blade – Narrow	PK-ZS-008	1			
Ground Blade – Wide	PK-ZS-011	1			
Ground Blade, Narrow	PK-ZS-021			1	
Ground Blade, Wide	PK-ZS-015			2	
Micro-Grabber Pair	PK-ZS-007R and PK-ZS-007B	1		2	
Offset Ground	PK-ZS-016			2	

## Specifications ZS1000 ZS1500 ZS2500 ZS4000

### Electrical Characteristics

Probe Bandwidth	1 GHz	1.5 GHz	2.5 GHz	4 GHz
Input Capacitance		0.9 pF		0.6 pF
DC Input Resistance			1 M $\Omega$	
Probe Offset Range	N/A		$\pm 12$ V	
Attenuation			$\div 10$	
Input Dynamic Range			$\pm 8$ V	
Non-destruct Voltage			20 V	

### General Characteristics

Cable Length	1.3 m
--------------	-------

Accessory Description	Replacement Part Number	ZS1000	ZS1500	ZS2500	ZS4000
Offset Ground – Z Lead	PK-ZS-002	1			
Pogo Ground Lead	PK-ZS-020				1
Pogo Ground Lead	PACC-CD008	1			
Pogo Tip	PK-ZS-017				3
Pogo Tip	PK-ZS-013	1			
Probe Tip – Standard	PK-ZS-001	3			3
QFPIC Clips (set of 2)	PK-ZS-025				1
Right Angle Lead – Long	PACC-LD004	1			1
Right Angle Lead – Short	PACC-LD003	1			1
Right Angle Socket	PK-ZS-006	1			1
Straight Pin Lead – Long	PK-ZS-023				1
Straight Pin Lead – Long	PK-ZS-004	1			
Straight Pin Lead – Short	PK-ZS-022				1
Straight Pin Lead – Short	PK-ZS-003	1			
Y Lead Adapter	PK-ZS-005	1			
Y Lead Adaptor	PK-ZS-014				1

# CURRENT PROBES

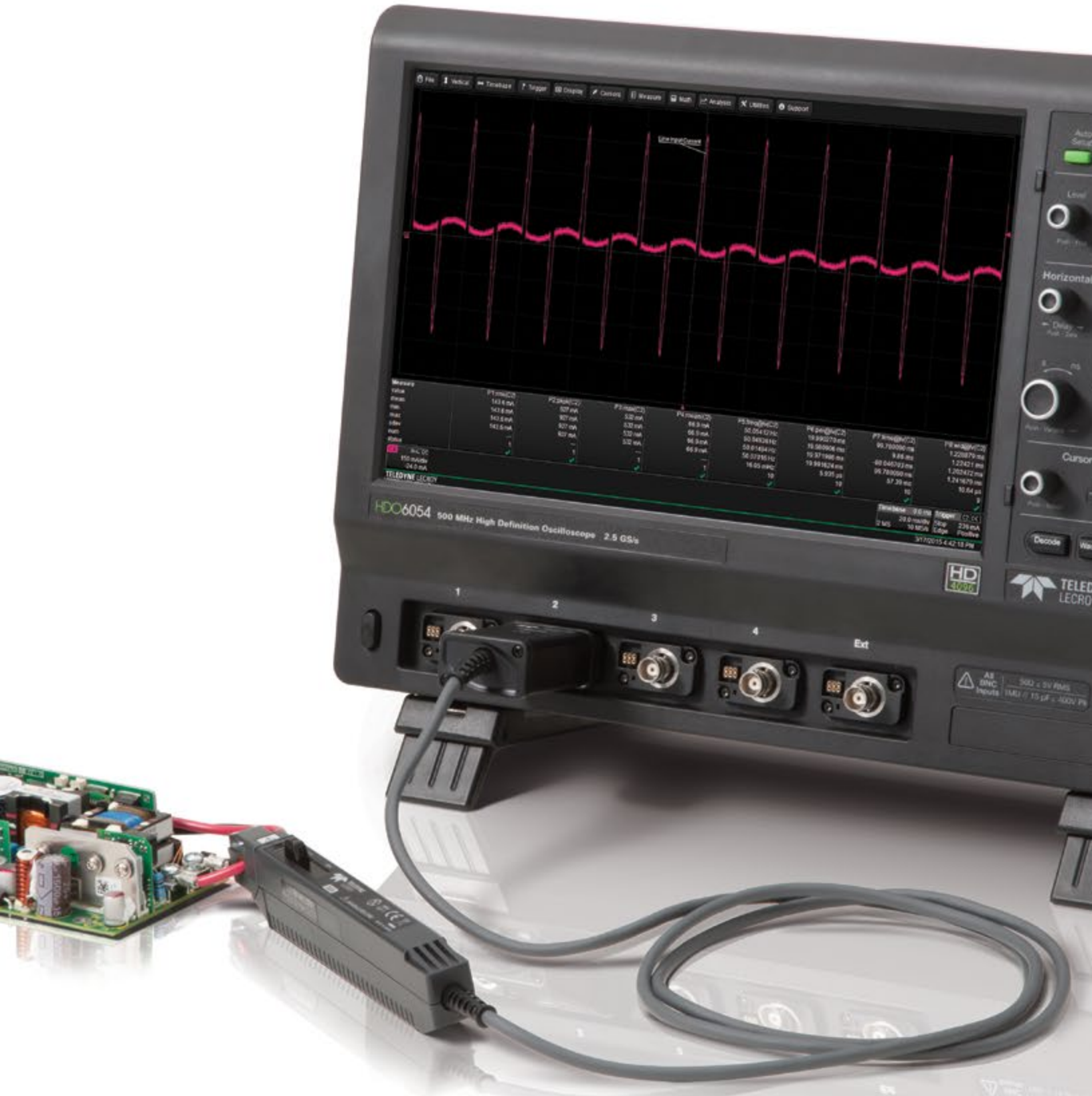

**Teledyne LeCroy current probes do not require the breaking of a circuit or the insertion of a shunt to make accurate and reliable current measurements. Based on a combination of Hall effect and transformer technology, Teledyne LeCroy current probes are ideal for making accurate AC, DC, and impulse current measurements.**

## Wide Range of Applications

Teledyne LeCroy current probes are available in a variety of models for a wide range of applications. The full range of Teledyne LeCroy current probes includes models with bandwidths up to 100 MHz, peak currents up to 700 A and sensitivities to 1 mA/div. Teledyne LeCroy current probes are often used in applications such as the design and test of switching power supplies, motor drives, electric vehicles, and uninterruptible power supplies.

## High Sensitivity

The CP030A and CP031A provide a high sensitivity of 1 mA/div. This allows for more precise low current measurements on Teledyne LeCroy oscilloscopes. When used with HDO high definition oscilloscopes with HD4096 technology, users will obtain highly accurate, low current waveforms with unmatched 12-bit resolution for improved debug and analysis.

## Fully Integrated

All Teledyne LeCroy current probes are powered through the Teledyne LeCroy ProBus® connection and require no additional hardware. Along with providing power, the ProBus connection allows the current probe and oscilloscope to communicate, resulting in current waveforms automatically displayed on screen in Amps, and calculated power traces scaled correctly in Watts. This full integration also allows for Degauss and Autozero functions to be done directly from the oscilloscope's user interface.

## Deskew Calibration Source

The DCS015 deskew calibration source has both voltage and current time-aligned signals, which enables the precise deskew of voltage and current probes. Most voltage probes along with the CP030, CP030A, CP031, and CP031A are compatible with the DSC015.

Teledyne LeCroy  
Current Probe  
and Adapter  
Model Numbers:

CP030  
CP030A  
CP031  
CP031A  
CP150  
CP500  
DCS015  
CA10

*Opposite page:  
CP031, 30A, 100 MHz Current Probe.*

# CURRENT PROBES



Teledyne LeCroy  
Current Probe  
and Adapter  
Model Numbers:

**CP030**

**CP030A**

**CP031**

**CP031A**

**CP150**

**CP500**

**DCS015**

**CA10**

## Key Features

- ProBus active probe interface with automatic scaling in A/div
- Autozero and degauss capabilities built into instrument's user interface
- Wide range of input currents and bandwidth capabilities



### CP030

- 30 A<sub>rms</sub> continuous current
- 50 A<sub>peak</sub> current
- 50 MHz bandwidth



### CP030A

- 30 A<sub>rms</sub> continuous current
- 50 A<sub>peak</sub> current
- 50 MHz bandwidth
- 1 mA/div sensitivity



### CP031

- 30 A<sub>rms</sub> continuous current
- 50 A<sub>peak</sub> current
- 100 MHz bandwidth



### CP031A

- 30 A<sub>rms</sub> continuous current
- 50 A<sub>peak</sub> current
- 100 MHz bandwidth
- 1 mA/div sensitivity



### CP150

- 150 A<sub>rms</sub> continuous current
- 500 A<sub>peak</sub> current
- 10 MHz bandwidth



### CP500

- 500 A<sub>rms</sub> continuous current
- 700 A<sub>peak</sub> current
- 2 MHz bandwidth



### DCS015

- Precise skew of voltage and current probes.
- Compatible with the CP031, CP031A, CP030, and CP030A



## CA10 Current Sensor Adapter

The CA10 enables a third-party current measurement device to operate like a Teledyne LeCroy probe. The CA10 is programmable and customizable to work with third-party current measurement devices that output voltage or current signals proportional to measured current. (See page 48 for more information and specifications).

### Specifications

#### Electrical Characteristics\*

	CP030 (CP030-3M)	CP030A	CP031	CP031A	CP150 (CP150-6M)	CP500
Max. Continuous Input Current	30 A <sub>rms</sub>				150 A <sub>rms</sub>	500 A <sub>rms</sub>
Bandwidth	50 MHz (10 MHz)		100 MHz		10 MHz (5 MHz)	2 MHz
Rise Time (typical)	≤ 7 ns (≤ 35 ns)		≤ 3.5 ns		≤ 35 ns (≤ 70 ns)	≤ 175 ns
Max. Peak Current	50 A <sub>peak</sub> (non-continuous)				300 A <sub>peak</sub> (non-continuous); 500 A <sub>peak</sub> ≤ 30 μs	700 A <sub>peak</sub> (non-continuous)
Output Voltage	0.1 V/A	0.1 V/A & 1 V/A	0.1 V/A	0.1 V/A & 1 V/A	0.01 V/A	
Max Continuous Input Current at 1 V/A (100mA/div or less)	–	5 A	–	5 A	–	
Offset Range at 1V/A (100mA/div or less)	–	±5 A	–	±5 A	–	
Minimum Sensitivity	10 mA/div	1 mA/div	10 mA/div	1 mA/div	100 mA/div	
Low-Frequency Accuracy	1%					
AC Noise at 20 MHz BWL	≤ 2.5 mA	≤ 150 μA	≤ 2.5 mA	≤ 150 μA	≤ 6.0 mA	≤ 8.0 mA
Coupling	AC, DC, GND					

### General Characteristics

Cable Length	1.5 m (3 m)		1.5 m		2 m (6 m)	6 m
Weight	240 g (290 g)	260 g	240 g	260 g	500 g (600 g)	630 g
Max. Conductor Size (Diameter)	5 mm				20 mm	
Interface	ProBus, 1 MΩ only					
Usage Environment	Indoor					
Operating Temperature	0° C to 40° C					
Max. Relative Humidity	80%					
Max. Altitude	2000 m					
Maximum Insulated Wire Voltage	300 V CAT I				600 V CAT II, 300 V CAT III	

\* Electrical Characteristics Guaranteed at 23 °C ±3 °C

CP03x, CP150, and CP500 probes (and long cable versions of these) are compatible with any Teledyne LeCroy oscilloscope with a ProBus interface running firmware version 4.3.1.1 or great.

CP03xA probes are compatible with most Teledyne LeCroy oscilloscopes with a ProBus interface running X-Stream™ firmware version 7.8.x.x or later, including WaveSurfer Xs-A, MXs/MXs-A/MXs-B, and 10; HDO4000, 6000, 8000, and 9000; MDA800, HRO/WaveRunner 6 Zi, WaveRunner 8000, Xi/Xi-A/MXi/MXi-A, WavePro/SDA/DDA 7 Zi/Zi-A; WaveMaster/SDA/DDA 8 Zi/Zi-A/Zi-B, and LabMaster 9 Zi-A series. WavePro 7000/7000A series are compatible if they are running Windows XP Professional and X-Stream™ firmware version 7.8.x.x or later. WaveSurfer Xs series must be upgraded to Windows XP Professional. Contact your local service center regarding upgrades.

## Ordering Information

### Product Description

Product Description	Product Code
ProBus Current Sensor Adapter	CA10
Set of 4 CA10, ProBus Current Sensor Adapters	CA10-QUADPAK
30 A; 50 MHz Current Probe – AC/DC; 30 A <sub>rms</sub> ; 50 A Peak Pulse, 1.5 meter cable	CP030
30 A; 10 MHz Current Probe – AC/DC, 30 A <sub>rms</sub> ; 50 A Peak Pulse, 3 meter cable (not EMC compliant)	CP030-3M
30 A; 50 MHz High Sensitivity Current Probe – AC/DC; 30 A <sub>rms</sub> ; 50 A Peak Pulse, 1.5 meter cable	CP030A
30 A; 100 MHz Current Probe – AC/DC; 30 A <sub>rms</sub> ; 50 A Peak Pulse, 1.5 meter cable	CP031
30 A; 100 MHz High Sensitivity Current Probe – AC/DC; 30 A <sub>rms</sub> ; 50 A Peak Pulse, 1.5 meter cable	CP031A
150 A; 10 MHz Current Probe – AC/DC; 150 A <sub>rms</sub> ; 500 A Peak Pulse, 2 meter cable	CP150
150 A; 5 MHz Current Probe – AC/DC; 150 A <sub>rms</sub> ; 500 A Peak Pulse, 6 meter cable (not EMC compliant)	CP150-6M
500 A; 2 MHz Current Probe – AC/DC; 500 A <sub>rms</sub> ; 700 A Peak Pulse, 6 meter cable	CP500
Deskew Calibration Source for CP031,CP031A, CP030, CP030A and AP015	DCS015

# DIFFERENTIAL PROBES

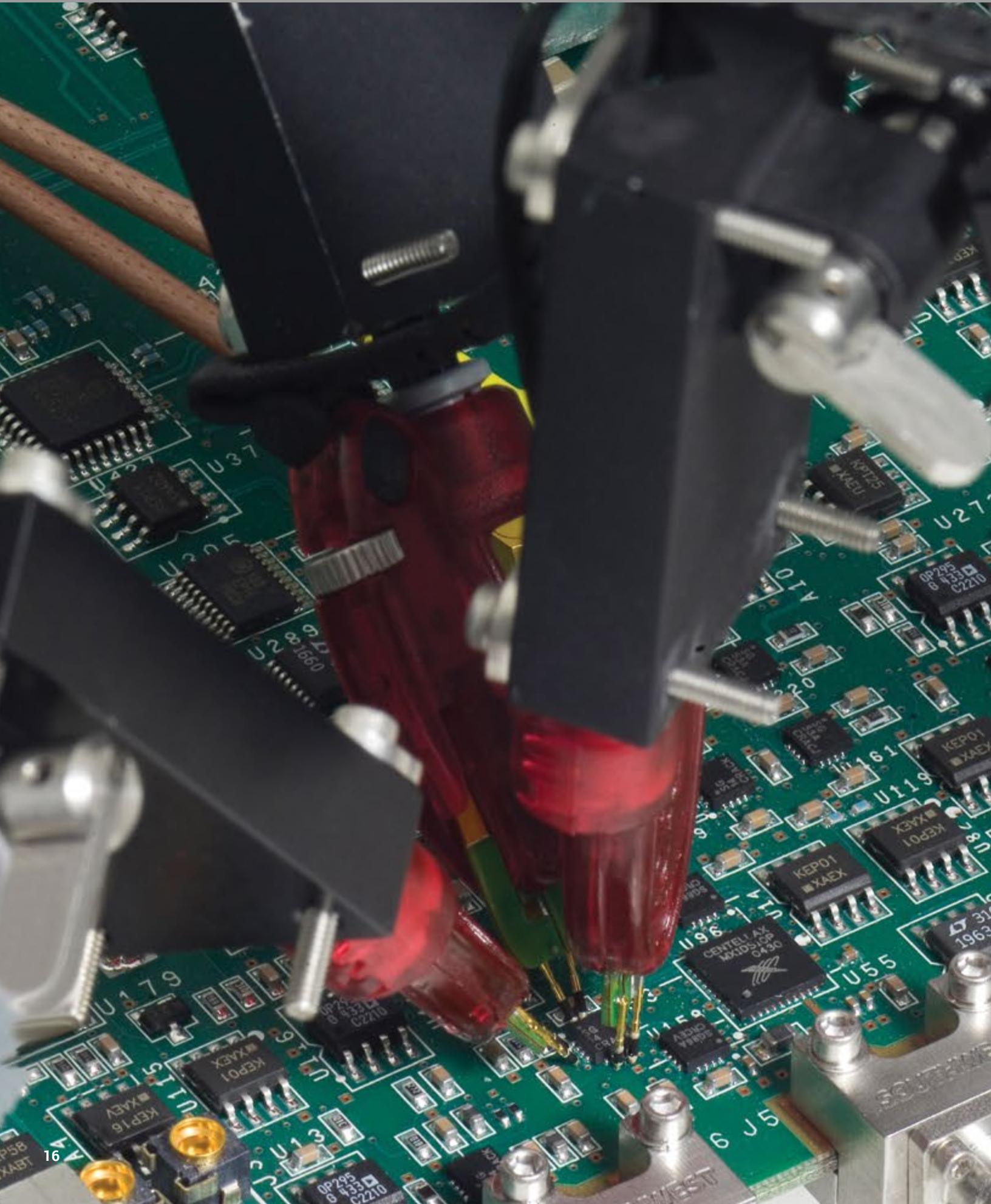



**Differential active probes are like two probes in one. Instead of measuring a test point in relation to a ground point (like single-ended active probes), differential probes measure the difference in voltage of a test point in relation to another test point.**

Teledyne LeCroy  
Differential Probe  
Model Numbers:

≤ 1.5 GHz

ZD200

ZD500

ZD1000

ZD1500

AP033

4 GHz - 6 GHz

D410-A-PS

D420-A-PS

D400A-AT

D610-A-PS

D620-A-PS

D600A-AT

8 GHz - 13 GHz

D830-PS

D1030-PS

D1330-PS

13 GHz - 25 GHz

D1305-A-PS

D1605-A-PS

D2005-A-PS

D2505-A-PS

*Opposite page:  
WaveLink® High Bandwidth Differential Probing System  
(13 GHz – 25 GHz)*

# ≤ 1.5 GHz DIFFERENTIAL PROBES



Teledyne LeCroy  
≤1.5 GHz  
Differential Probe  
Model Numbers:

ZD200  
ZD500  
ZD1000  
ZD1500  
AP033

The ZD Series probes provide wide dynamic range, excellent noise and loading performance and an extensive set of probe tips, leads, and ground accessories to handle a wide range of probing scenarios. The low 1 pF capacitance means this probe is ideal for all frequencies. The ZD Series differential probes provide full system bandwidth for all Teledyne LeCroy Oscilloscopes 1.5 GHz and lower.

## Fully Integrated

With the ProBus interface, the ZD500, 1000, and 1500 become an integral part of the oscilloscope. All probe gain and offset controls are transparent to the user, making it easier to probe the circuit without concern for which gain setting to choose. When used with a Teledyne LeCroy digital oscilloscope, no external power supply is required.

## Wide Dynamic Range

The ZD500, 1000, 1500 probes provide transparent probe attenuation so signals are always optimized for the display. The differential range is 18 V<sub>p-p</sub> with a differential offset of ±8V and common mode range of ±10 V, making these probes versatile for every probing application.

## Wide Applications

The wide dynamic range of 16 V<sub>p-p</sub> and offset range of ±8V suit this probe to a wide range of applications and signal types. The ZD differential probes are ideally suited for Automotive, Serial Data, power, and general purpose use.

## Specifications

### Electrical Characteristics

	ZD200	ZD500	ZD1000	ZD1500
Bandwidth (Warranted)	200 MHz	500 MHz	1000 MHz	1500 MHz
Bandwidth (Typical)	-	650 MHz	1200 MHz	1700 MHz
Risetime 10–90% (Typical)	1.75 ns	650 ps	375 ps	270 ps
Risetime 20–80% (Typical)	-	500 ps	280 ps	200 ps
LF Attenuation Accuracy (Warranted)	1%		2%	
Zero Offset (Typical) (within 15 minutes after autozero)	-		5 mV	
System Noise (Typical)	-	1.3 mV <sub>rms</sub>		1.75 mV <sub>rms</sub>
Probe Noise Density (Typical)	3 mV <sub>rms</sub>		38 nV/rt (Hz)	
Input Differential Range (Nominal)	± 20 V		±8 V (16 V <sub>p-p</sub> )	
Differential Offset Range (Nominal)	-		±18 V	
Offset Gain Accuracy (Typical)	-		2%	
Common Mode Range (Nominal)	± 60 V		±10 V	
Maximum Non-destruct Voltage (Nominal)	-		30 V	
CMRR (Typical)	80 dB @ 60 Hz 50 dB @ 10 MHz	60 dB 50/60 Hz 30 dB 20 MHz 25 dB 500 MHz	60 dB 50/60 Hz 30 dB 20 MHz 25 dB @ 1000 MHz	60 dB 50/60 Hz 30 dB 20 MHz 25 dB @ 1500 MHz
DC Input Resistance (Nominal)	250 kΩ (Common Mode) 1 MΩ (Differential Mode)		50 kΩ (Common Mode) 120 kΩ (Differential Mode)	
Differential Input Capacitance (Typical)	3.5 pF		< 1.0 pF	

## Ordering Information

### Product Description

Product Description	Product Code
200 MHz, 3.5 pF, 1 MΩ Active Differential Probe	ZD200
500 MHz, 1.0 pF Active Differential Probe, ±8 V	ZD500
1 GHz, 1.0 pF Active Differential Probe, ±8 V	ZD1000
1.5 GHz, 1.0 pF Active Differential Probe, ±8 V	ZD1500

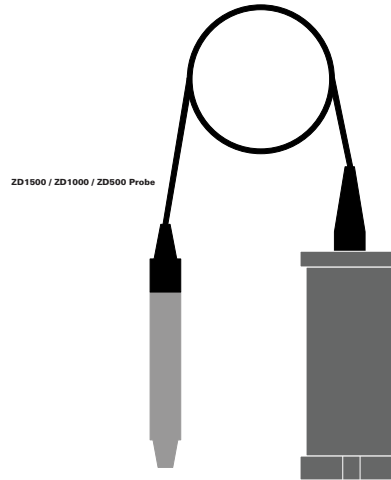

PCF200  
Probe Calibration Fixture

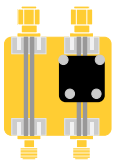

PACC-MS001  
Hands Free Probe Holder

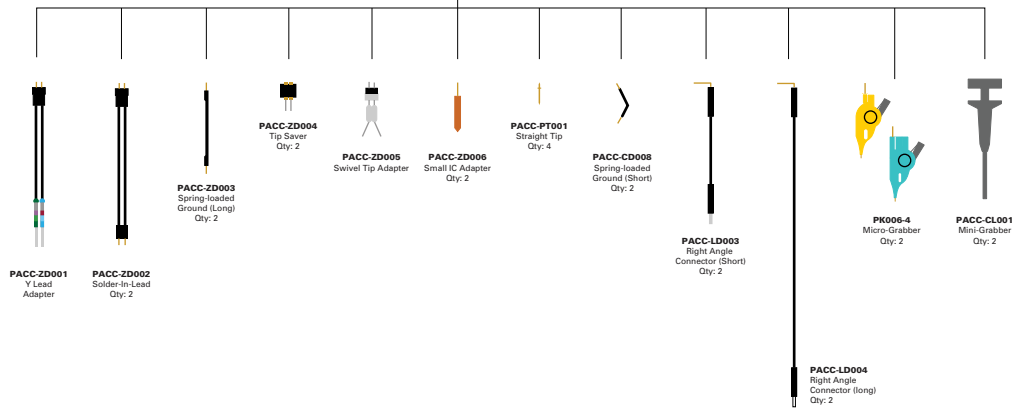
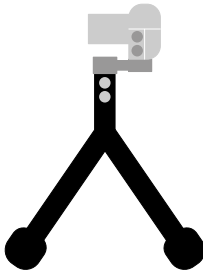

## AP033

High bandwidth, excellent common-mode rejection ratio (CMRR) and low noise make these active differential probes ideal for applications such as disk drive design and failure analysis, as well as wireless and data communication design.



## Specifications

Bandwidth	500 MHz
Gain	x10, x1, ÷10 (÷100 with plug-on ÷10 attenuator)
DC Accuracy	1% in x1 without external attenuator
Input Resistance	1 MΩ each input to ground 2 MΩ differential between inputs
Differential Mode Range	±400 mV (x1) ±40 mV (x10) ±4 V (÷10) ±40 V (÷100)
Offset Range	±400 mV (x1, x10) ±4 V (±10) ±40 V (±100)
Common-Mode Range	±42 V peak (±10) +4.2 V peak (±100)
CMRR	70 Hz 10,000:1 (80 dB) 100 kHz 10,000:1 (80 dB) 1 MHz 1000:1 (60 dB) 10 MHz 100:1 (40 dB) 250 MHz 5:1 (14 dB)

## Ordering Information

### Product Description

500 MHz Differential Probe

### Product Code

AP033

# 4 GHz - 6 GHz DIFFERENTIAL PROBES



Teledyne LeCroy  
4 GHz - 6 GHz  
Differential Probe  
Model Numbers:

**D410-A-PS**  
**D420-A-PS**  
**D400A-AT**  
**D610-A-PS**  
**D620-A-PS**  
**D600A-AT**

Teledyne LeCroy's WaveLink 4-6 GHz Differential Probes are a general purpose probing solution with high-input dynamic range and offset range capability. The range of capabilities is ideal for a variety of high-speed DDR signals where high dynamic range and large offset requirements are common.

## Key Features

- **4 GHz or 6 GHz models**
- **Up to 5 Vpk-pk dynamic range with low noise**
- **±3 V offset range**
- **Ideal for DDR2, LPDDR2, DDR3**
- **Innovative QuickLink architecture**
- **Wide variety of tips and leads**
  - Solder-In Lead
  - QuickLink Solder-In Lead
  - Positioner (Browser) Tip
  - Adjustable (Browser) Tip
  - Quick Connect Lead
  - Square Pin Lead
  - Hi-Temp Solder-In Lead
- **Low loading and high impedance for minimal signal disturbance**
- **Deluxe soft carrying case**

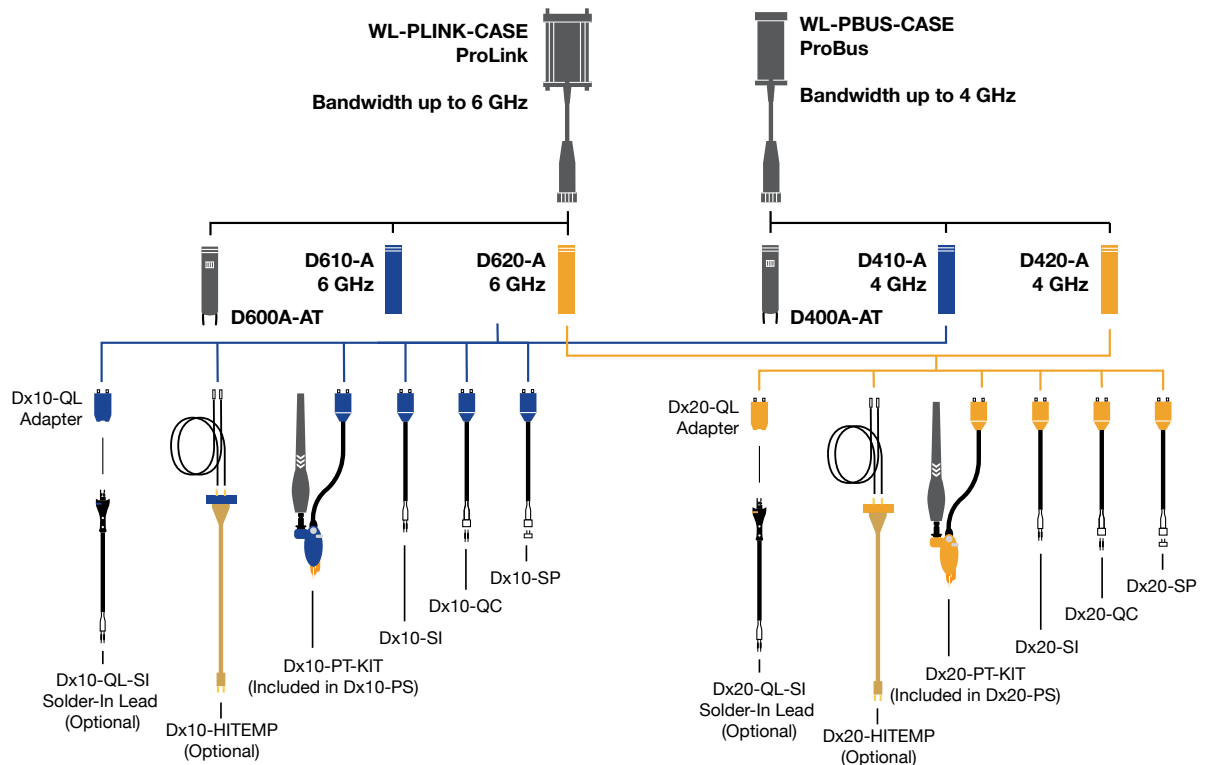

# 4 GHz - 6 GHz DIFFERENTIAL PROBES

	D610-A, D610-A-PS	D620-A, D620-A-PS	D410-A, D410-A-PS	D420-A, D420-A-PS	D600A-AT	D400A-AT
<b>Bandwidth*</b> (Probe only, guaranteed) (System bandwidth, typical)	Dx10-SI, Dx10-QL-SI and Dx10-PT Tips 6 GHz  Dx10-HiTemp 5 GHz  Dx10-QC Tip 4 GHz  Dx10-SP Tip 3 GHz	Dx20-SI, Dx20-QL-SI and Dx20-PT Tips 6 GHz  Dx20-HiTemp 5 GHz  Dx20-QC Tip 4 GHz  Dx20-SP Tip 3 GHz	Dx10-SI, Dx10-QL-SI, Dx10-HiTemp, Dx10-QC and Dx10-PT Tips 4 GHz  Dx10-SP Tip 3 GHz	Dx20-SI, Dx20-QL-SI, Dx20-HiTemp, Dx20-QC and Dx20-PT Tips 4 GHz  Dx20-SP Tip 3 GHz	6 GHz	4 GHz
<b>Rise Time* (10–90%)</b>	Dx10-SI, Dx10-QL-SI and Dx10-PT Tips 75 ps (typical)  Dx10-HiTemp 90 ps (typical)  Dx10-QC Tip 122.5 ps (typical)  Dx10-SP Tip 150 ps (typical)	Dx20-SI, Dx20-QL-SI and Dx20-PT Tips 75 ps (typical)  Dx20-HiTemp 90 ps (typical)  Dx20-QC Tip 122.5 ps (typical)  Dx20-SP Tip 150 ps (typical)	Dx10-SI, Dx10-QL-SI, Dx10-HiTemp, Dx10-QC and Dx10-PT Tips 112 ps (typical)  Dx10-QC Tip 122.5 ps (typical)  Dx10-SP Tip 150 ps (typical)	Dx20-SI, Dx20-QL-SI, Dx20-HiTemp, Dx20-QC and Dx20-PT Tips 112 ps (typical)  Dx20-QC Tip 122.5 ps (typical)  Dx20-SP Tip 150 ps (typical)	<75 ps (typical)	<112 ps (typical)
<b>Rise Time* (20–80%)</b>	Dx10-SI, Dx10-QL-SI and Dx10-PT Tips 56 ps (typical)  Dx10-HiTemp 67.5 ps (typical)  Dx10-QC Tip 92 ps (typical)  Dx10-SP Tip 113 ps (typical)	Dx20-SI, Dx20-QL-SI and Dx20-PT Tips 56 ps (typical)  Dx20-HiTemp 67.5 ps (typical)  Dx20-QC Tip 92 ps (typical)  Dx20-SP Tip 113 ps (typical)	Dx10-SI, Dx10-QL-SI, Dx10-HiTemp, Dx10-QC and Dx10-PT Tips 84 ps (typical)  Dx10-QC Tip 92 ps (typical)  Dx10-SP Tip 113 ps (typical)	Dx20-SI, Dx20-QL-SI, Dx20-HiTemp, Dx20-QC and Dx20-PT Tips 84 ps (typical)  Dx20-QC Tip 92 ps (typical)  Dx20-SP Tip 113 ps (typical)	56 ps (typical)	84 ps (typical)
<b>Noise (System)</b>	<36 nV/√Hz (2.8 mVrms) (typical) Referred to input, 6 GHz bandwidth	<61 nV/√Hz (4.8 mVrms) (typical) Referred to input, 6 GHz bandwidth	<36 nV/√Hz (2.3 mVrms) (typical) Referred to input, 4 GHz bandwidth	<67 nV/√Hz (4.3 mVrms) (typical) Referred to input, 4 GHz bandwidth	<74 nV/√Hz (5.8 mVrms) (typical) Referred to input, 6 GHz bandwidth	<74 nV/√Hz (4.7 mVrms) (typical) Referred to input, 4 GHz bandwidth

<b>Input</b>						
<b>Input Dynamic Range (Nominal)</b>	2.5Vpk-pk, ±1.25V	5Vpk-pk, ±2.5V	2.5Vpk-pk, ±1.25V	5Vpk-pk, ±2.5V	4.8Vpk-pk, ±2.4V	
<b>Input Common Mode Voltage Range (Nominal)</b>	±4 V				±2.4 Vmax	
<b>Input Offset Voltage Range</b>	±3 V Differential (nominal)				n/a	
<b>Non-destructive Input Range (Nominal)</b>	±20 V				±18 V	
<b>Attenuation</b>	1.7X / 1.0X (nominal)	3.2X / 1.9X (nominal)	1.7X / 1.0X (nominal)	3.2X / 1.9X (nominal)	2.5X	
<b>DC Input Resistance (Nominal)</b>	200 kΩ Differential 50 kΩ Common Mode				4 kΩ Differential 1 kΩ Common Mode	

\* All bandwidth and rise time measurements are made with an oscilloscope bandwidth greater or equal to the probe bandwidth  
† Through entire frequency range

## Product Description Product Code

### Complete Probe Systems

4 GHz Complete Probe System with Dx10-SI Solder-In Tip (Qty. 1), Dx10-SP Square Pin (Qty. 1), Dx10-QC Quick Connect (Qty. 1), and Dx10-PT-KIT Positioner Tip Browser (Qty. 1)	D410-A-PS
4 GHz Complete Probe System with Dx20-SI Solder-In Tip (Qty. 1), Dx20-SP Square Pin (Qty. 1), Dx20-QC Quick Connect (Qty. 1), and Dx20-PT-KIT Positioner Tip Browser (Qty. 1)	D420-A-PS
6 GHz Complete Probe System with Dx10-SI Solder-In Tip (Qty. 1), Dx10-SP Square Pin (Qty. 1), Dx10-QC Quick Connect (Qty. 1), and Dx10-PT-KIT Positioner Tip Browser (Qty. 1)	D610-A-PS
6 GHz Complete Probe System with Dx20-SI Solder-In Tip (Qty. 1), Dx20-SP Square Pin (Qty. 1), Dx20-QC Quick Connect (Qty. 1), and Dx20-PT-KIT Positioner Tip Browser (Qty. 1)	D620-A-PS

### Amplifier and Probe Tip Modules

WaveLink D410-A 4 GHz/2.5Vp-p Differential Probe Amplifier with Dx10-SI Solder-In Tip (Qty. 1), Dx10-SP Square Pin (Qty. 1), and Dx10-QC Quick Connect (Qty. 1)	D410-A
WaveLink D420-A 4 GHz/5Vp-p Differential Probe Amplifier with Dx20-SI Solder-In Tip (Qty. 1), Dx20-SP Square Pin (Qty. 1), and Dx20-QC Quick Connect (Qty. 1)	D420-A
WaveLink D610-A 6 GHz/2.5Vp-p Differential Probe Amplifier with Dx10-SI Solder-In Tip (Qty. 1), Dx10-SP Square Pin (Qty. 1), and Dx10-QC Quick Connect (Qty. 1)	D610-A
WaveLink D620-A 6 GHz/5Vp-p Differential Probe Amplifier with Dx20-SI Solder-In Tip (Qty. 1), Dx20-SP Square Pin (Qty. 1), Dx20-QC Quick Connect (Qty. 1)	D620-A
WaveLink D400A-AT 4 GHz/4.8Vp-p Differential Amplifier Module with Adjustable Tip	D400A-AT
WaveLink D600A-AT 6 GHz/4.8Vp-p Differential Amplifier Module with Adjustable Tip	D600A-AT

-PS COMPONENTS

## Product Description Product Code

<b>Positioner Tip (Browser) Kits</b>	
WaveLink Dx10-PT Adjustable Positioner Tip Kit. For use with Dx10 amplifiers.	Dx10-PT-KIT
WaveLink Dx20-PT Adjustable Positioner Tip Kit. For use with Dx20 amplifiers.	Dx20-PT-KIT
<b>Probe Platform/Cable Assemblies and Adapters</b>	
WaveLink ProLink Platform/Cable Assembly Kit with complete soft carrying case for all probe items.	WL-PLINK-CASE
WaveLink ProBus Platform/Cable Assembly Kit with complete soft carrying case for all probe items.	WL-PBUS-CASE
<b>QuickLink Solder-In Tip Set</b>	
QuickLink Solder-In starter pack for use with Dx10 amplifier. Includes one QuickLink adapter and three QL-SI tips.	Dx10-QL-3SI
QuickLink Solder-In starter pack for use with Dx20 amplifier. Includes one QuickLink adapter and three QL-SI tips.	Dx20-QL-3SI

### Hi-Temp Leads

WaveLink Temperature Extension Cables for Dx10. Includes set of Matched 30" High Temperature Cables (Qty. 1) and solder-in lead set (Qty. 1)	Dx10-HiTemp
WaveLink Temperature Extension Cables for Dx20. Includes set of Matched 30" High Temperature Cables (Qty. 1) and solder-in lead set (Qty. 1)	Dx20-HiTemp

# 8 GHz - 13 GHz DIFFERENTIAL PROBES



Teledyne LeCroy  
8 GHz - 13 GHz  
Differential Probe  
Model Numbers:

**D830-PS**

**D1030-PS**

**D1330-PS**

The WaveLink Differential Probe Series is a 8-13 GHz bandwidth active differential probe series with high input dynamic range, a large offset capability, and a wide variety of tips and leads available for different applications.

## Key Features

- Choice of 8, 10, or 13 GHz bandwidth models
- 3.5 Vpk-pk dynamic range
- $\pm 4$  V offset range
- Ideal for DDR3, DDR4, LPDDR3
- Innovative QuickLink architecture
- Wide variety of tips and leads
  - Solder-In Lead
  - QuickLink Solder-In Lead
  - Positioner (Browser) Tip
  - SMA/SMP Lead
  - Square Pin Lead
  - Hi-Temp Solder-In Lead
- Low loading and high impedance for minimal signal disturbance
- Deluxe soft carrying case
- SMA/SMP lead set accessory does not require purchase of a different amplifier

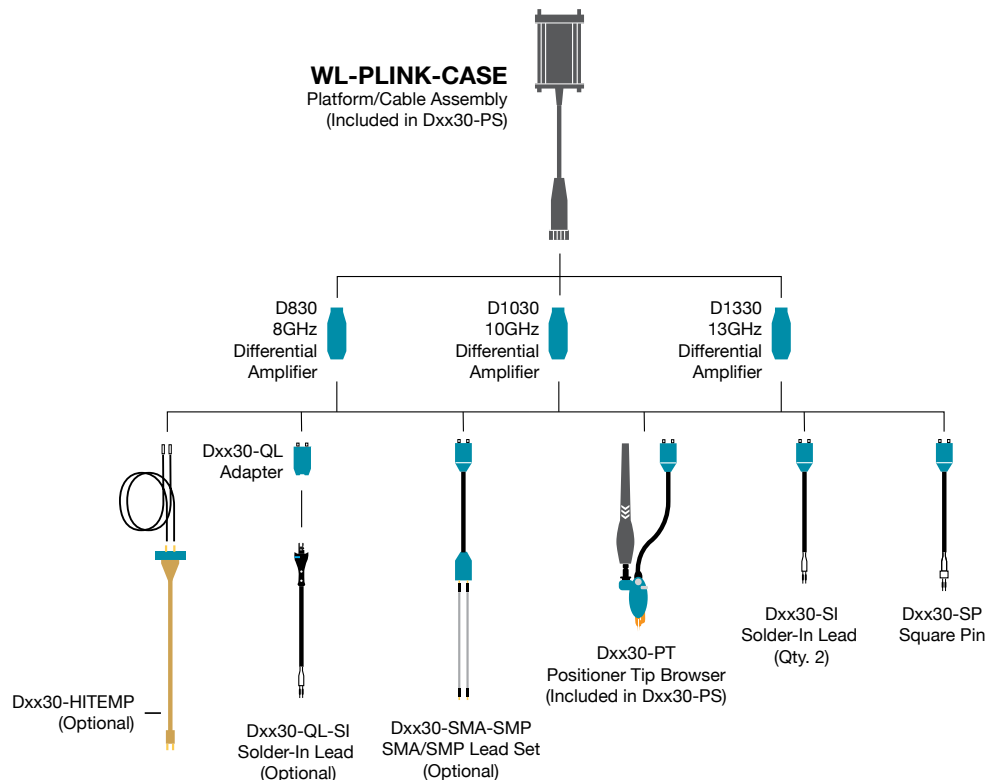

# 8 GHz - 13 GHz DIFFERENTIAL PROBES

	<b>D830, D830-PS</b>	<b>D1030, D1030-PS</b>	<b>D1330, D1330-PS</b>
<b>Bandwidth*</b> (Probe only, guaranteed) (System bandwidth, typical)	<b>Dxx30-SI, Dxx30-QL-SI, Dxx30-SMA-SMP, Dxx30-HiTemp, and Dxx30-PT Tips</b> 8 GHz  <b>Dxx30-SP Tip</b> 3 GHz	<b>Dxx30-SI, Dxx30-SMA-SMP, Dxx30-HiTemp, and Dxx30-PT Tips</b> 10 GHz  <b>Dxx30-QL-SI Tip</b> 8 GHz  <b>Dxx30-SP Tip</b> 3 GHz	<b>Dxx30-SI and Dxx30-SMA-SMP Tips</b> 13 GHz  <b>Dxx30-PT and Dxx30-HiTemp Tips</b> 10 GHz  <b>Dxx30-QL-SI Tip</b> 8 GHz  <b>Dxx30-SP Tip</b> 3 GHz
<b>Rise Time* (10–90%)</b>	<b>Dxx30-SI, Dxx30-QL-SI, Dxx30-SMA-SMP, Dxx30-HiTemp, and Dxx30-PT Tips</b> 50 ps (typical)  <b>Dxx30-SP Tip</b> 132 ps (typical)	<b>Dxx30-SI, Dxx30-SMA-SMP, Dxx30-HiTemp, and Dxx30-PT Tips</b> 40 ps (typical)  <b>Dxx30-QL-SI Tip</b> 50 ps (typical)  <b>Dxx30-SP Tip</b> 132 ps (typical)	<b>Dxx30-SI and Dxx30-SMA-SMP Tips</b> 35 ps (typical)  <b>Dxx30-PT and Dxx30-HiTemp Tips</b> 40 ps (typical)  <b>Dxx30-QL-SI Tip</b> 50 ps (typical)  <b>Dxx30-SP Tip</b> 132 ps (typical)
<b>Rise Time* (20–80%)</b>	<b>Dxx30-SI, Dxx30-QL-SI, Dxx30-SMA-SMP, Dxx30-HiTemp, and Dxx30-PT Tips</b> 37.5 ps (typical)  <b>Dxx30-SP Tip</b> 100 ps (typical)	<b>Dxx30-SI, Dxx30-SMA-SMP, Dxx30-HiTemp, and Dxx30-PT Tips</b> 30 ps (typical)  <b>Dxx30-QL-SI Tip</b> 37.5 ps (typical)  <b>Dxx30-SP Tip</b> 100 ps (typical)	<b>Dxx30-SI and Dxx30-SMA-SMP Tips</b> 26 ps (typical)  <b>Dxx30-PT and Dxx30-HiTemp Tips</b> 30 ps (typical)  <b>Dxx30-QL-SI Tip</b> 37.5 ps (typical)  <b>Dxx30-SP Tip</b> 100 ps (typical)
<b>Noise (Probe)</b>	<48 nV/√Hz (4.3 mVrms) (typical) Referred to input, 8 GHz bandwidth.	<48 nV/√Hz (4.8 mVrms) (typical) Referred to input, 10 GHz bandwidth.	<48 nV/√Hz (5.5 mVrms) (typical) Referred to input, 13 GHz bandwidth.
<b>Noise (System)</b>	<52 nV/√Hz (4.6 mVrms) (typical) Referred to input, 8 GHz bandwidth.	<52 nV/√Hz (5.2 mVrms) (typical) Referred to input, 10 GHz bandwidth.	<52 nV/√Hz (5.9 mVrms) (typical) Referred to input, 13 GHz bandwidth.
<b>Input</b>			
<b>Input Dynamic Range</b>	3.5Vpk-pk, ±1.75V (nominal)		
<b>Input Common Mode Voltage Range</b>	±5 V (nominal)		
<b>Input Offset Voltage Range</b>	±4 V Differential (nominal)		
<b>Non-destructive Input Range</b>	±15 V (nominal)		
<b>Attenuation</b>	3.75x (nominal)		
<b>DC Input Resistance (nominal)</b>	200 kΩ Differential 50 kΩ Common mode		
<b>Impedance (Zmin, typical)</b>	>250 Ω Differential through entire frequency range using SI tip		
<b>Impedance (mid-band, typical)</b>	<b>Dxx30-SI, Dxx30-QL-SI, and Dxx30-HiTemp Tips</b> 470 Ω at 4 GHz, 320 Ω at 6 GHz, 260 Ω at 8 GHz, 250 Ω at 9 GHz, 260 Ω at 10 GHz, 350 Ω at 13 GHz  <b>Dxx30-PT Tip</b> 155 Ω at 4 GHz, 210 Ω at 6 GHz, 140 Ω at 8 GHz, 80 Ω at 9 GHz, 40 Ω at 10 GHz		
<b>CMRR</b>	58 dB DC / 100 Hz 38 dB to 10 MHz 30 dB to 3 GHz 20 dB to 8 GHz (typical)		

\* All Bandwidth and Rise Time measurements are made with an oscilloscope bandwidth greater or equal to the probe bandwidth

	<b>Product Description</b>	<b>Product Code</b>	<b>Product Description</b>	<b>Product Code</b>
	<b>Complete Probe Systems</b>		<b>QuickLink Solder-In Tip Set</b>	
	8 GHz Complete Probe System with Dxx30-SI Solder-In Tip (Qty. 2), Dxx30-SP Square Pin (Qty. 1), and Dxx30-PT-KIT Positioner Tip Browser (Qty. 1)	D830-PS	QuickLink Solder-In starter pack for use with Dxx30 amplifier. Includes one QuickLink adapter and three QL-SI tips.	Dxx30-QL-3SI
	10 GHz Complete Probe System with Dxx30-SI Solder-In Tip (Qty. 2), Dxx30-SP Square Pin (Qty. 1), and Dxx30-PT-KIT Positioner Tip Browser (Qty. 1)	D1030-PS	<b>Hi-Temp Lead Set</b>	Dxx30-HiTemp
	13 GHz Complete Probe System with Dxx30-SI Solder-In Tip (Qty. 2), Dxx30-SP Square Pin (Qty. 1), and Dxx30-PT-KIT Positioner Tip Browser (Qty. 1)	D1330-PS	WaveLink Temperature Extension Cables for Dxx30. Includes set of Matched 30" High Temperature Cables (Qty. 1) and solder-in lead set (Qty. 1).	
<b>-PS COMPONENTS</b>	<b>Amplifier and Probe Tip Modules</b>		<b>SMA/SMP Lead Set</b>	
	WaveLink D830 8 GHz/3.5V <sub>p-p</sub> Differential Probe Amplifier with Dxx30-SI Solder-In Tip (Qty. 2) and Dxx30-SP Square Pin (Qty. 1)	D830	SMA/SMP lead set for use with Dxx30 amplifiers. Includes a set of SMA leads, SMP leads, pair of DC blocks and SMA finger wrenches.	Dxx30-SMA-SMP-LEADS
	WaveLink D1030 10 GHz/3.5V <sub>p-p</sub> Differential Probe Amplifier with Dxx30-SI Solder-In Tip (Qty. 2) and Dxx30-SP Square Pin (Qty. 1)	D1030	<b>Accessories</b>	
	WaveLink D1330 13 GHz/3.5V <sub>p-p</sub> Differential Probe Amplifier with Dxx30-SI Solder-In Tip (Qty. 2) and Dxx30-SP Square Pin (Qty. 1)	D1330	Cascade Microtech EZ-Probe Positioner	EZ PROBE
	<b>Positioner Tip (Browser) Kits</b>		Probe Deskew and Calibration Test Fixture	TF-DSQ
	WaveLink Dxx30-PT (up to 10 GHz rating) Adjustable Positioner Tip Kit. For use with Dxx30 amplifiers.	Dxx30-PT-KIT	<b>Calibration Options</b>	
	<b>Probe Platform/Cable Assemblies and Adapters</b>		NIST Calibration for D830. Includes test data.	D830-CCNIST
	WaveLink ProLink Platform/Cable Assembly Kit with complete soft carrying case for all probe items.	WL-PLINK-CASE	NIST Calibration for D1030. Includes test data.	D1030-CCNIST
			NIST Calibration for D1330. Includes test data.	D1330-CCNIST
			<b>Replacement Parts</b>	
			Single replacement QuickLink Solder-In Tip	QL-SI-1Pack
			9-pack of replacement QuickLink Solder-In Tip	QL-SI-9Pack
			Replacement Dxx30-SP 8-13 GHz Square Pin Lead	Dxx30-SP
			Replacement Dxx30-SI 8-13 GHz Solder-In Lead with Qty. 5 Spare Resistors.	Dxx30-SI

# 13 GHz - 25 GHz DIFFERENTIAL PROBES



Teledyne LeCroy  
13 GHz - 25 GHz  
Differential Probe  
Model Numbers:

**D1305-A-PS**  
**D1605-A-PS**  
**D2005-A-PS**  
**D2505-A-PS**

## Ultra-wideband Architecture for Superior Signal Fidelity

Teledyne LeCroy's WaveLink® high bandwidth differential probes utilize advanced differential traveling wave (distributed) amplifier architecture to achieve superior high frequency true analog broadband performance. Traveling wave (distributed) amplifiers are commonly used in ultra high frequency broadband amplifiers. This multi-stage amplifier architecture maximizes gain per stage and minimizes probe attenuation, which provides very low probe noise and fast rise times.

## Key Features

- Up to 25 GHz bandwidth (probe + oscilloscope)
- System rise time as fast as 13 ps (20–80%)
- 25 GHz Solder-in solution
- 22 GHz ultra-compact browser tip
- Superior probe impedance minimizes AC loading on device under test (DUT)
- Carbon-composite browser tips optimize signal fidelity and minimize loading
- Probe noise as low as 14 nV/√Hz (1.6 mV<sub>rms</sub>)
- Low probe attenuation
- Large operating voltage range
  - ±4 V common mode range
  - ±2.5 V offset range
  - 2.0 V<sub>pk-pk</sub> dynamic range
- Long length Solder-In tip with field replaceable resistors

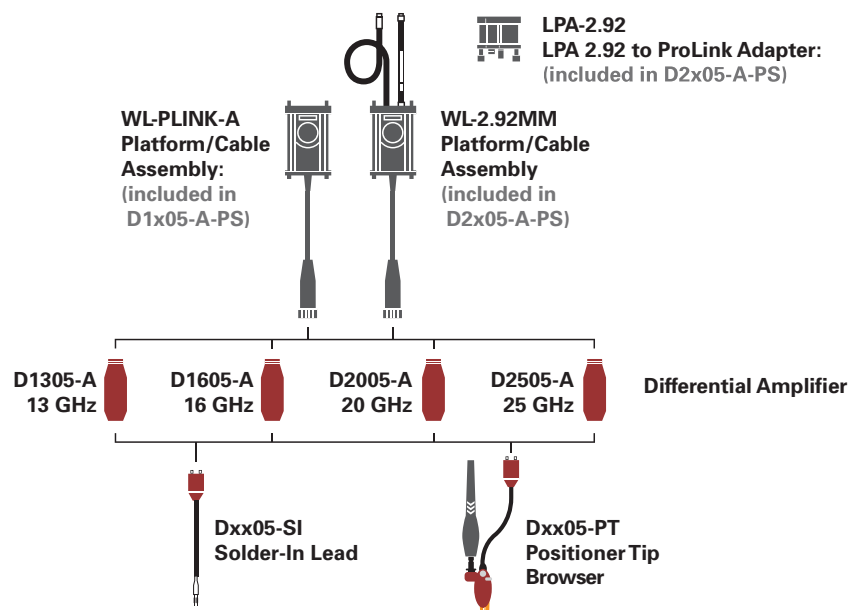



# 13 GHz - 25 GHz DIFFERENTIAL PROBES

	D1305-A, D1305-A-PS	D1605-A, D1605-A-PS	D2005-A, D2005-A-PS	D2505-A, D2505-A-PS
<b>Bandwidth</b>	<b>Dxx05-SI and Dxx05-PT Tips</b> 13 GHz (probe only, guaranteed) 13 GHz (system bandwidth, when used with 813Zi, typical)	<b>Dxx05-SI and Dxx05-PT Tips</b> 16 GHz (probe only, guaranteed) 16 GHz (system bandwidth, when used with 816Zi, typical)	<b>Dxx05-SI and Dxx05-PT Tips</b> 20 GHz (probe only, guaranteed) 20 GHz (system bandwidth, when used with 820Zi, typical)	<b>Dxx05-SI Lead</b> 25 GHz (probe only, guaranteed) 25 GHz (system bandwidth, when used with 825Zi, typical) <b>Dxx05-PT Tip</b> 22 GHz (system bandwidth, when used with 825Zi, typical) 20 GHz (probe only, guaranteed)
<b>Rise Time (10–90%)</b>	<b>Dxx05-SI and Dxx05-PT Tips</b> 32.5 ps (typical) System rise time measured with $\geq 13$ GHz oscilloscope	<b>Dxx05-SI and Dxx05-PT Tips</b> 28 ps (typical) System rise time measured with $\geq 16$ GHz oscilloscope	<b>Dxx05-SI and Dxx05-PT Tips</b> 20 ps (typical) System rise time measured with $\geq 20$ GHz oscilloscope	<b>Dxx05-SI Lead</b> 17.5 ps (typical) System rise time measured with $\geq 25$ GHz oscilloscope <b>Dxx05-PT Tip</b> 19 ps (typical) System rise time measured with $\geq 25$ GHz oscilloscope
<b>Rise Time (20–80%)</b>	<b>Dxx05-SI and Dxx05-PT Tips</b> 24.5 ps (typical) System rise time measured with $\geq 13$ GHz oscilloscope	<b>Dxx05-SI and Dxx05-PT Tips</b> 21 ps (typical) System rise time measured with $\geq 16$ GHz oscilloscope	<b>Dxx05-SI and Dxx05-PT Tips</b> 15 ps (typical) System rise time measured with $\geq 20$ GHz oscilloscope	<b>Dxx05-SI Lead</b> 13 ps (typical) System rise time measured with $\geq 25$ GHz oscilloscope <b>Dxx05-PT Tip</b> 14 ps (typical) System rise time measured with $\geq 25$ GHz oscilloscope
<b>Noise (Probe)</b>	< 14 nV/ $\sqrt{\text{Hz}}$ (1.6 mV <sub>rms</sub> ) (typical) Referred to input, 13 GHz bandwidth	< 14 nV/ $\sqrt{\text{Hz}}$ (1.8 mV <sub>rms</sub> ) (typical) Referred to input, 16 GHz bandwidth	< 18 nV/ $\sqrt{\text{Hz}}$ (2.5 mV <sub>rms</sub> ) (typical) Referred to input, 20 GHz bandwidth	< 18 nV/ $\sqrt{\text{Hz}}$ (2.8 mV <sub>rms</sub> ) (typical) Referred to input, 25 GHz bandwidth
<b>Noise (System)</b>	< 23 nV/ $\sqrt{\text{Hz}}$ (2.7 mV <sub>rms</sub> ) (typical) Referred to input, 13 GHz bandwidth	< 23 nV/ $\sqrt{\text{Hz}}$ (2.9 mV <sub>rms</sub> ) (typical) Referred to input, 16 GHz bandwidth	< 28 nV/ $\sqrt{\text{Hz}}$ (4.0 mV <sub>rms</sub> ) (typical) Referred to input, 20 GHz bandwidth	< 28 nV/ $\sqrt{\text{Hz}}$ (4.5 mV <sub>rms</sub> ) (typical) Referred to input, 25 GHz bandwidth

<b>Input</b>				
<b>Input Dynamic Range</b>	2.0 V <sub>pk-pk</sub> ( $\pm 1.0$ V) (nominal)			
<b>Input Common Mode Voltage Range</b>	$\pm 4$ V (nominal)			
<b>Input Offset Voltage Range</b>	$\pm 2.5$ V Differential (nominal)			
<b>Non-destructive Input Range</b>	$\pm 10$ V (nominal)			
<b>Attenuation</b>	3.5x (nominal)		4.5x (nominal)	
<b>DC Input Resistance (Nominal)</b>	1.1 k $\Omega$ Differential 100 k $\Omega$ Common mode			
<b>Impedance (Z<sub>min</sub>, typical)</b>	<b>Dxx05-SI Lead</b> > 300 $\Omega$ Differential through entire frequency range <b>Dxx05-PT Tip</b> > 160 $\Omega$ Differential through entire frequency range	<b>Dxx05-SI Lead</b> > 300 $\Omega$ Differential through entire frequency range <b>Dxx05-PT Tip</b> > 160 $\Omega$ Differential through entire frequency range	<b>Dxx05-SI Lead</b> > 230 $\Omega$ Differential through entire frequency range <b>Dxx05-PT Tip</b> > 160 $\Omega$ Differential through entire frequency range	<b>Dxx05-SI Lead</b> > 120 $\Omega$ Differential through entire frequency range <b>Dxx05-PT Tip</b> > 160 $\Omega$ Differential through entire frequency range
<b>Impedance (mid-band, typical)</b>	<b>Dxx05-SI Lead:</b> 300 $\Omega$ at 6 GHz, 525 $\Omega$ at 13 GHz, 600 $\Omega$ at 16 GHz, 300 $\Omega$ at 20 GHz, 120 $\Omega$ at 25 GHz <b>Dxx05-PT Tip:</b> 160 $\Omega$ at 6 GHz, 450 $\Omega$ at 13 GHz, 240 $\Omega$ at 16 GHz, 210 $\Omega$ at 20 GHz			

Product Description	Product Code
<b>Complete Probe Systems</b>	
13 GHz Complete Probe System with Solder-In Tip (13 GHz) and Positioner Tip Browser (13 GHz)	D1305-A-PS
16 GHz Complete Probe System with Solder-In Tip (16 GHz) and Positioner Tip Browser (16 GHz)	D1605-A-PS
20 GHz Complete Probe System with Solder-In Tip (20 GHz) and Positioner Tip Browser (20 GHz)	D2005-A-PS
25 GHz Complete Probe System with Solder-In Tip (25 GHz) and Positioner Tip Browser (22 GHz)	D2505-A-PS
<b>Amplifier and Probe Tip Modules</b>	
WaveLink D1305 13 GHz/1.6 V <sub>pk-pk</sub> Differential Probe Amplifier with Dxx05-SI Solder-In Tip (Qty. 2)	D1305-A
WaveLink D1605 16 GHz/1.6 V <sub>pk-pk</sub> Differential Probe Amplifier with Dxx05-SI Solder-In Tip (Qty. 2)	D1605-A
WaveLink D2005 20 GHz/1.6 V <sub>pk-pk</sub> Differential Probe Amplifier with Dxx05-SI Solder-In Tip (Qty. 2)	D2005-A
WaveLink D2505 25 GHz/1.6 V <sub>pk-p</sub> Differential Probe Amplifier with Dxx05-SI Solder-In Tip (Qty. 2)	D2505-A
<b>Positioner Tip (Browser) Kits</b>	
WaveLink Dxx05-PT (Up to 22 GHz Rating) Adjustable Positioner Tip Kit. For use with Dxx05 Amplifiers	Dxx05-PT-KIT
<b>Probe Platform/Cable Assemblies and Adapters</b>	
WaveLink ProLink Platform/Cable Assembly Kit for $\geq 13$ GHz WaveLink Probes	WL-PLINK-A-CASE
WaveLink 2.92 mm Platform/Cable Assembly Kit for $\geq 20$ GHz WaveLink Probes	WL-2.92MM-CASE
ProLink to 2.92 mm Adapter with Probe Power and Communication Pass Through	LPA-2.92

Product Description	Product Code
<b>Accessories</b>	
Cascade Microtech EZ-Probe Positioner	EZ PROBE
Probe Deskew and Calibration Test Fixture	TF-DSQ
<b>Calibration Options</b>	
NIST Calibration for D1305. Includes Test Data	D1305-A-CCNIST
NIST Calibration for D1605. Includes Test Data	D1605-A-CCNIST
NIST Calibration for D2005. Includes Test Data	D2005-A-CCNIST
NIST Calibration for D2505. Includes Test Data	D2505-A-CCNIST
<b>Replacement Parts</b>	
Replacement Dxx05-SI 13–25 GHz Solder-In Lead with Qty. 5 Spare Resistors	Dxx05-SI
Replacement SI Resistor Kit for Dxx05-SI Solder-In Tip	Dxx05-SI-RESISTORS
Replacement Dxx05-PT Positioner Tip	Dxx05-PT
Qty. 4 Replacement Carbon Composite Pogo-pin Tips	Dxx05-PT-TIPS
Replacement Probe Tip Holder Kit	PK600ST-3
Replacement Platform/Cable Assembly Mounting Kit	PK600ST-4
Qty. 1 Package of Black Adhesive Pads (10/pkg.) and Qty. 1 Package of White Adhesive Pads (10/pkg.)	Dxx05-PT-TAPE
Qty. 1 Package of Adhesive Probe Connection Guides (200 individual guides/package)	Dxx05-PT-GUIDES

# HIGH VOLTAGE DIFFERENTIAL PROBES



# HIGH VOLTAGE DIFFERENTIAL PROBES

**Differential active probes are like two probes in one. Instead of measuring a test point in relation to a ground point (like single-ended active probes), differential probes measure the difference in voltage of a test point in relation to another test point.**

Teledyne LeCroy  
High Voltage  
Differential Probe  
Model Numbers:

**HVD3102**

**HVD3106**

**HVD3106-6M**

**HVD3206**

**HVD3206-6M**

**HVD3605**

**AP031**

**ADP300**

**ADP305**

*Opposite page:  
HVD3000 Series High Voltage Differential Probes  
working with an HDO8000 High Definition Oscilloscope.*

# HIGH VOLTAGE DIFFERENTIAL PROBES

Teledyne LeCroy  
High Voltage  
Differential Probe  
Model Numbers:

HVD3102

HVD3106

HVD3106-6M

HVD3206

HVD3206-6M

HVD3605



The HVD3000 series high voltage differential probes provide high CMRR over a broad frequency range to simplify the measurement challenges found in noisy, high common-mode power electronics environments. The probe's design is easy-to-use and enables safe, precise high voltage floating measurements.

## Key Features

- 1 kV, 2 kV, 6 kV CAT safety rated models
- World's only 1500 V<sub>DC</sub> safety rated probe per IEC/EN 61010-031:2015
- Widest differential voltage ranges available
- Exceptional common-mode rejection ratio (CMRR) across a broad frequency range
- 1% gain accuracy
- High offset capability at both high and low attenuation
- AC and DC coupling
- ProBus active probe interface with automatic scaling
- Auto-zero capabilities
- Wide oscilloscope compatibility

# HIGH VOLTAGE DIFFERENTIAL PROBES

	HVD3102	HVD3106	HVD3106-6M	HVD3206	HVD3206-6M	HVD3605
<b>Bandwidth</b>	25 MHz	120 MHz	80 MHz	120 MHz	80 MHz	100 MHz
<b>Differential Voltage Range</b>		1500 V (DC + peak AC) (2000V maximum typical measurable before saturation)		2000 V (DC + peak AC)		7000 V (DC + peak AC) (7600 V maximum typical measurable before saturation)
<b>Max Safe Input Voltage</b>		1000 V <sub>rms</sub> CAT III		2000 V (DC + peak AC) CAT I 1500 V <sub>dc</sub> CAT III 1000 V <sub>rms</sub> CAT III		8485 V (DC + peak AC) CAT I 6000 V <sub>rms</sub> CAT I 1000 V <sub>rms</sub> CAT III 1000 V <sub>dc</sub> CAT III
<b>Gain Accuracy</b>	1%					
<b>Cable Length</b>	2.25 meters		6.8 meters	2.25 meters	6.8 meters	6.8 meters
<b>Included Tip Accessories</b>	Yes	Yes	Yes	Yes	Yes	Yes

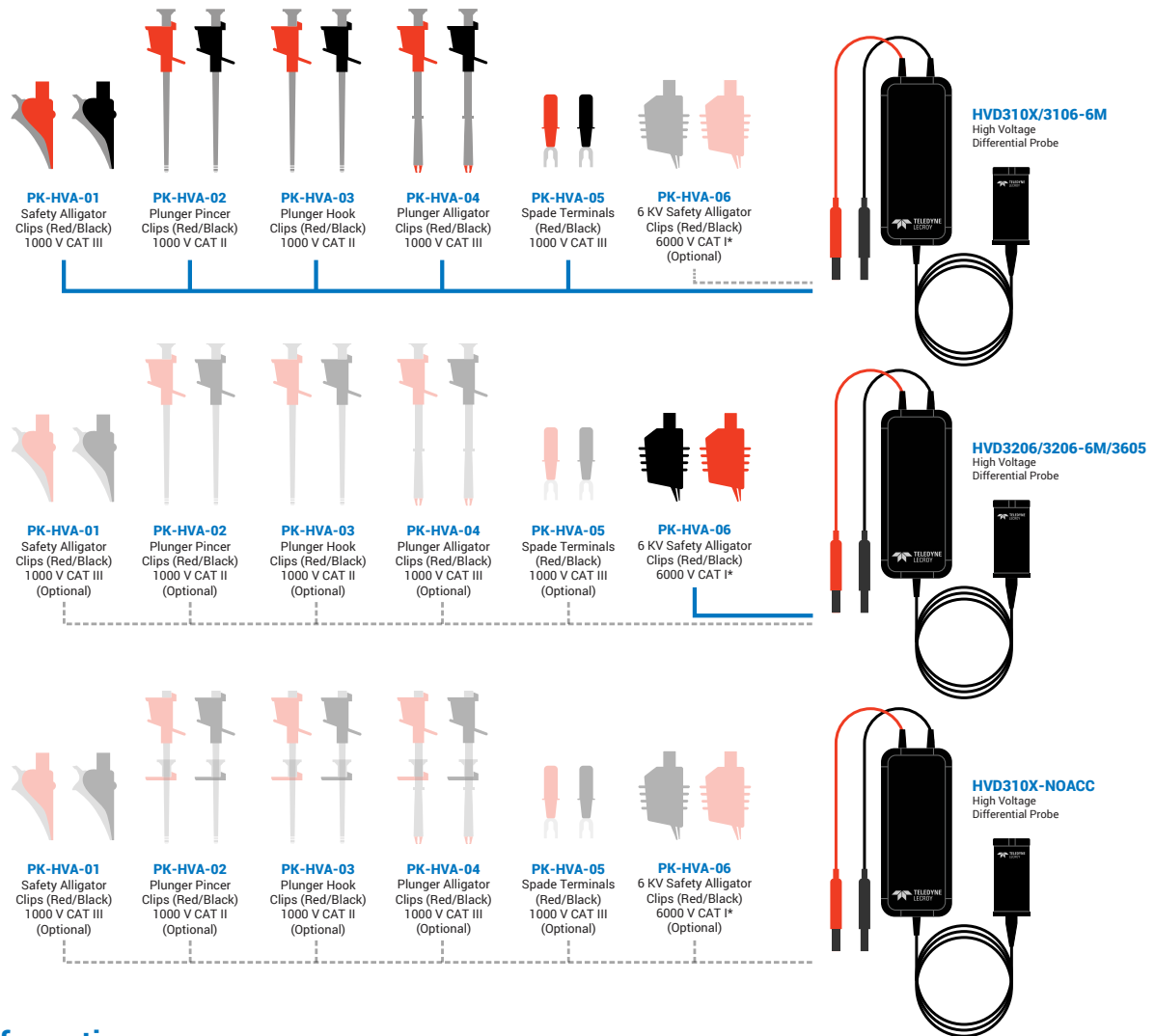

## Ordering Information

### Product Description

- 1 kV, 25 MHz High Voltage Differential Probe with 2 m cable
- 1 kV, 120 MHz High Voltage Differential Probe with 2 m cable
- 1 kV, 80 MHz High Voltage Differential Probe with 6m cable
- 1 kV, 25 MHz High Voltage Differential Probe with 2 m cable without tip Accessories
- 1 kV, 120 MHz High Voltage Differential Probe with 2 m cable without tip Accessories
- 2 kV, 120 MHz High Voltage Differential Probe with 2 m cable
- 2 kV, 80 MHz High Voltage Differential Probe with 6 m cable
- 6 kV, 100 MHz High Voltage Differential Probe with 6 m cable
- High Voltage Replacement Accessories Kit (Includes 2 each, 1 Black, 1 Red):  
Safety Alligator Clips, Plunger Pincer Clips, Plunger Hook Clips, Plunger Alligator Clips, Spade Terminals

### Product Code

- HVD3102
- HVD3106
- HVD3106-6M
- HVD3102-NOACC
- HVD3106-NOACC
- HVD3206
- HVD3206-6M
- HVD3605
- PK-HV-001

# HIGH VOLTAGE DIFFERENTIAL PROBES

Teledyne LeCroy  
High Voltage  
Differential Probe  
Model Numbers:

**AP031**  
**ADP300**  
**ADP305**



## AP031

The AP031 is a low cost, battery operated active differential probe intended for measuring higher voltages. The differential techniques employed permit measurements to be taken at two points in a circuit without reference to the ground, allowing the oscilloscope to be safely grounded without the use of opto-isolators or isolating transformers.

## Key Features

- Safe floating measurements
- 15 MHz bandwidth
- 700 V maximum input voltage
- Works with any 1 M $\Omega$  input oscilloscope

## Specifications

Attenuation	$\div 10 / \div 100$
Bandwidth	15 MHz
Input R	4 M $\Omega$
Differential Mode Range	$\pm 70 \text{ V} / \pm 700 \text{ V DC} + \text{Peak AC}$
Common Mode Range	$\pm 700 \text{ V DC} + \text{Peak AC}$
CMRR	86 dB @ 50 Hz 56 dB @ 200 kHz

*Power Requirements: four AA batteries*

## Ordering Information

Product Description	Product Code
700 V, 15 MHz Differential Probe ( $\div 10, \div 100$ )	AP031
1,400 V, 20 MHz High-Voltage Differential Probe	AP300
1,400 V, 100 MHz High-Voltage Differential Probe	AP305

# HIGH VOLTAGE DIFFERENTIAL PROBES

## ADP30X

ADP30X high-voltage active probes are safe, easy-to-use, and ideally suited for measuring power electronics. The ADP300 is designed for troubleshooting low-frequency power devices and other circuits where the reference potential is elevated from the ground or the location of the ground is unknown. The ADP305 is designed for measuring the high-speed floating voltages found in today's power electronics.



## Key Features

- 20 MHz and 100 MHz bandwidth
- 1,000 V<sub>rms</sub> common mode voltage
- 1,400 V<sub>peak</sub> differential voltage
- EN 61010 CAT III
- 80 dB CMRR at 50/60 Hz
- ProBus system
- Full remote control

## Specifications

### Electrical Characteristics

Bandwidth	20 MHz (ADP300) 100 MHz (ADP305)
Differential Voltage	1,400 V peak
Common Mode Voltage	1,000 V rms CAT III
Low-Frequency Accuracy (Probe Only)	1% of Reading
CMRR	50/60 Hz 80 dB (10,000:1) 100 kHz 50 dB (300:1)
Max. Slew Rate (Referenced to Input)	60,000 V/μs (ADP300) 300,000 V/μs (ADP305)
AC Noise (Referenced to Input)	50 mV rms
Attenuation	÷100/÷1000 (automatically selected by scope)
Input Impedance	Between inputs 8 MΩ, 6 pF Each input to ground 4 MΩ, 1 pF
Sensitivity	1 V/div to 350 V/div (ADP300) 200 mV/div to 350 V/div (ADP305)
Interface	ProBus, 1 MΩ*

### General Characteristics

Overall Length	2 m
Input Connectors	4 mm Shrouded Banana Plug
Operating Temperature	0 °C to 50 °C
Warranty	1 year

\*Requires AP-1M for oscilloscopes with 50 Ω only inputs

# DIFFERENTIAL AMPLIFIERS

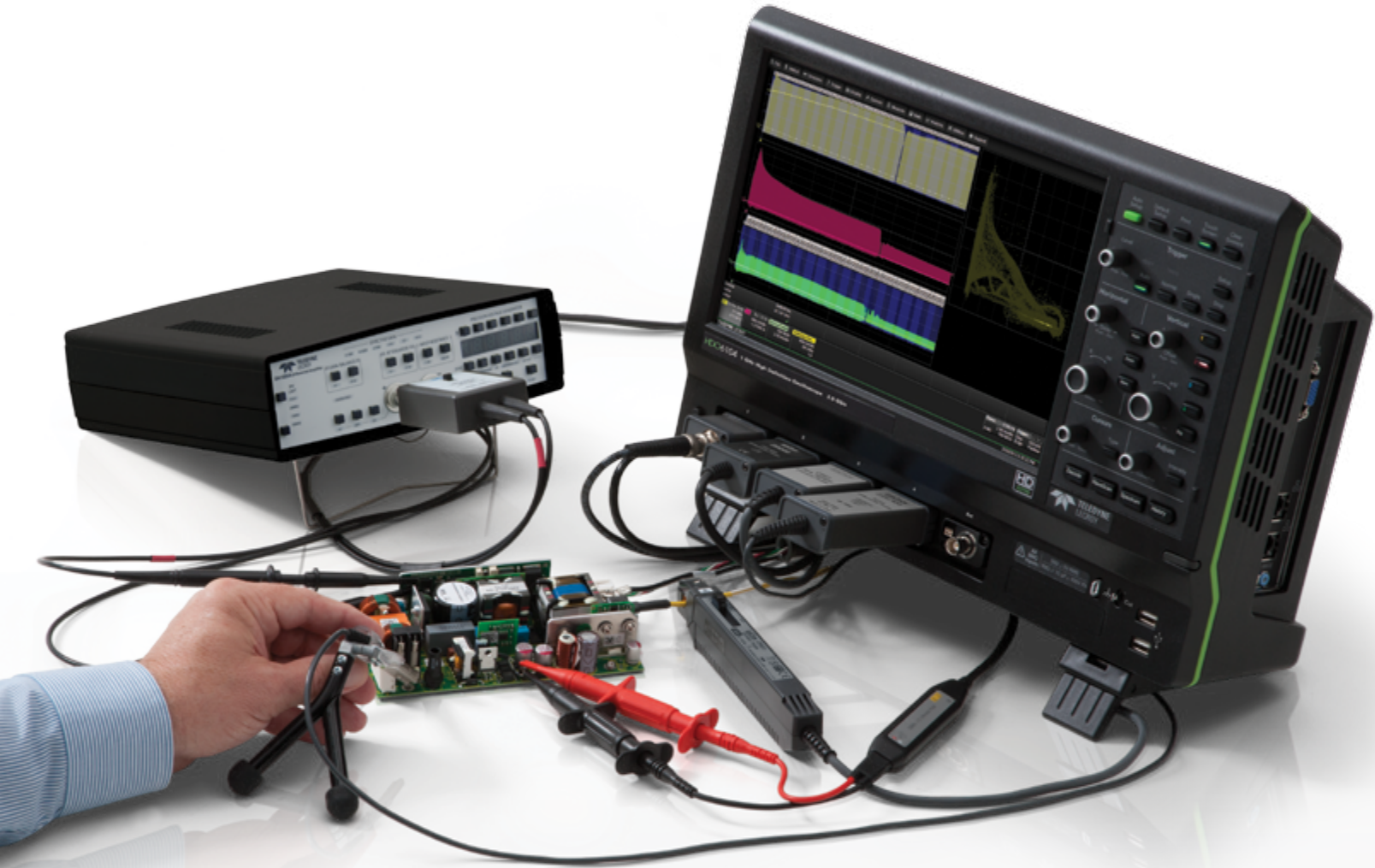



Differential amplifiers are intended to act as signal conditioning preamplifiers for oscilloscopes and network and spectrum analyzers, providing differential measurement capability to instruments having only a single-ended input. The "-PR2" version of each amplifier is a dual channel unit. The DXC series differential input cables are matched to the characteristics of the amplifier.

Teledyne LeCroy  
Differential Amplifier  
and Accessory  
Model Numbers:

DA1855A

DA1855-PR2

DA1855A-RM

DA1855A-PR2-RM

DXC5100

DXC100A

DXC200

DA101

*Opposite page:  
DA1855A Differential Amplifier working with the  
HDO6000 oscilloscope for power measurement.*

# DIFFERENTIAL AMPLIFIERS

Teledyne LeCroy  
Differential Amplifier  
and Accessory  
Model Numbers:

DA1855A  
DA1855-PR2  
DA1855A-RM  
DA1855A-PR2-RM  
DXC5100  
DXC100A  
DXC200  
DA101



## DA1855A

The DA1855A is a stand-alone, high-performance 100 MHz differential amplifier. It is intended to act as a signal conditioning preamplifier for oscilloscopes, digitizers and spectrum analyzers, providing differential measurement capability to instruments having only a single-ended input. When used with a DA1855A, oscilloscopes can obtain Common Mode Rejection Ratio (CMRR) and overdrive recovery performance levels previously unobtainable.

Amplifier gain can be set to 1 or 10. A built-in input attenuator can be separately set to attenuate signals by a factor of 10, providing gains of 10, 1, or 0.1 and common mode dynamic range of  $\pm 15.5 \text{ V} (\div 1)$  or  $\pm 155 \text{ V} (\div 10)$ . Optional probes increase the maximum input signal and common mode ranges

in proportion to their attenuation ratio but do not exceed their maximum input voltage rating. Effective gain of the DA1855A, including probe attenuation, amplifier gain and attenuator settings, is automatically displayed.

The DA1855A features a built-in Precision Voltage Generator (PVG) that can be set to any voltage between  $\pm 15.5 \text{ V}$  ( $\pm 10 \text{ V}$  in Differential Offset) with up to  $100 \mu\text{V}$  resolution. The PVG's output can be selected as an input to the inverting (-) input of the amplifier for operation as a differential comparator, or applied internally as a true differential offset voltage independent of oscilloscope offset. The differential amplifier is also available in a 2 channel model. In addition, a rackmount is available for each model for easy installation with other instruments.



## DXC100A

÷100 or ÷10 Selectable, 250 MHz Passive Differential Probe Pair

- DC to 100 MHz Bandwidth with DA1855A  
DC to 10 MHz Bandwidth with DA1822
- Max Input Voltage 500 V
- Selectable 10 or 100 Attenuation Factor
- 1.2 m Cable Length



## DXC200

÷1, 50 MHz, Passive Differential Probe Pair

- DC to 50 MHz with DA1855A  
DC to 10 MHz with DA1822A
- Max Input Voltage 500 V (Limited to Amplifier Max Input Voltage)
- x1 Differential Probe Pair
- 0.7 m Cable Length



## DXC5100

÷100, 2.5KV Passive High Voltage Probe Pair. Requires DA101 for full performance



## DA101

÷10, 1M $\Omega$  Passive Attenuator for DXC series probes

## Ordering Information

### Product Description

Product Description	Product Code
1 Ch, 100 MHz Differential Amplifier with Precision Voltage Source	DA1855A
2 Ch, 100 MHz Differential Amplifier with Precision Voltage Source	DA1855A-PR2
DA1855A with Rackmount	DA1855A-RM
DA1855A with Rackmount (must be ordered at time of purchase, no retrofit)	DA1855A-PR2-RM
÷100 or ÷10 Selectable, 250 MHz Passive Differential Probe Pair	DXC100A*
÷1, 50 MHz Passive Differential Probe Pair	DXC200*
÷100, 250 MHz 2.5 kV, High Voltage Probe Pair (requires DA101 for full performance)	DXC-5100*
÷10 1 M $\Omega$ Passive Attenuator for DXC Series Probes	DA101*

\*Must be used with DA Series Differential Amplifiers

# HIGH VOLTAGE PROBES

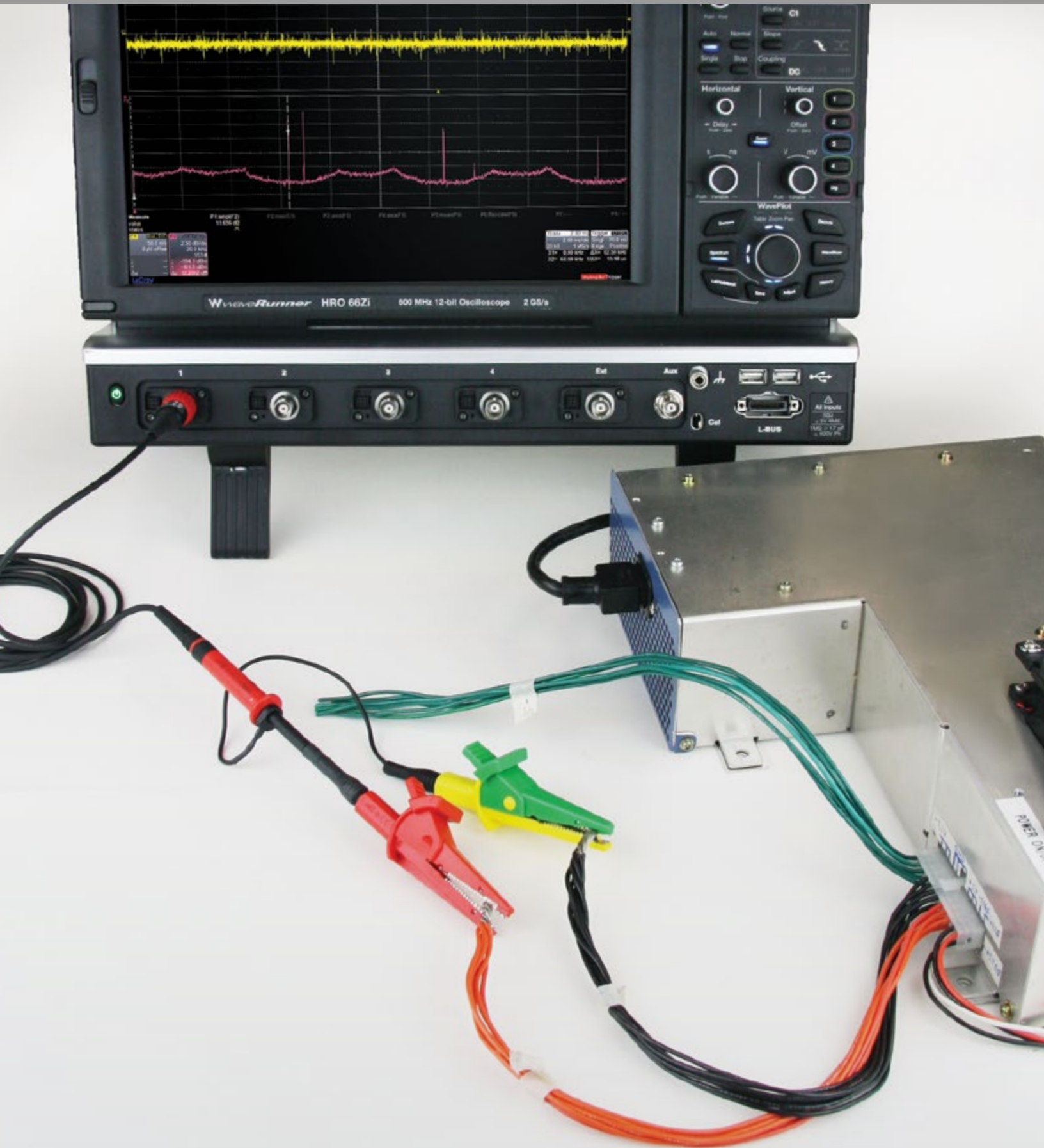

High voltage probes are suitable for a wide range of applications where high-voltage measurements must be made safely and accurately. There are several fixed attenuation probes covering a range from 1 kV to 6 kV and varying transient overvoltage ratings. All of these high voltage probes feature a spring loaded probe tip and a variety of standard accessories to make probing high voltages safe and easy. Additionally, all of the high voltage probe have a probe sense pin to automatically configure the oscilloscope for use with the probe.

Teledyne LeCroy  
High Voltage Probe  
Model Numbers:

HVP120  
PPE4KV  
PPE5KV  
PPE6KV

*Opposite page:  
PPE Series High Voltage Probe*

# HIGH VOLTAGE PROBES



Teledyne LeCroy  
High Voltage Probe  
Model Number:  
**HVP120**

The HVP120 is a high voltage passive probe designed for probing up to 1,000 Vrms and capable of handling up to 6,000 V peak transients. Its fast rise time and excellent frequency response make it suitable for a wide variety of high voltage measurement applications. The HVP120 features a spring loaded probe tip and a variety of standard accessories to make probing high voltages safe and easy.

## Electrical Characteristics

Bandwidth	400 MHz
Risetime (10% - 90%)	900 ps (typical)
Maximum Input Voltage*	
Measurement Category II	1000 Vrms
Measurement Category I	4000V Transient Overvoltage at 1000 Vrms 6000V Transient Overvoltage at 0 Vrms
Pollution Degree*	2
Input Capacitance	7.5 pF (typical)
Compensation Range	10 pF - 50 pF (typical)
Attenuation Ratio	100:1 ± 2%

## Environmental

Temperature (Operating)	0°C to 50°C
Temperature (Non-Operating)	-40°C to 71°C
Humidity (Operating)	80% RH (Non-Condensing) up to 31°C, decreasing linearly to 40% RH at 50°C
Altitude (Operating)	up to 2,000 m
Altitude (Non-Operating)	up to 15,000 m

## General Characteristics

Weight (probe)	67 g (0.15 lbs)
Cable Length	2 m (6.56 ft)
Probe Tip Diameter	5 mm (0.20 inches)

\*As defined in IEC 61010-031

## Ordering Information

### Product Description

400 MHz, High Voltage Passive Probe  
High Voltage Replacement Accessories Kit

### Product Code

HVP120  
PK-HV-002

## Replacement Accessories

One of each of the following accessories are included with the HVP120. Replacement quantities are listed below.

Coding Rings (set) 4 Colors (Qty 3 also included standard)	PK1-5MM-106
Ground Lead 22 cm to 4 mm Banana plug (Qty 1)	PK1-5MM-122
Solid Tip 0.8 mm (Qty 5)	PK1-5MM-125
Spring Tip 0.8 mm (Qty 5)	PK1-5MM-126
BNC Adapter 5.0-L (Qty 1)	PK1-5MM-127
Insulating Cap 5.0-L (Qty 1)	PK1-5MM-128
Protection Cap 5.0-L (Qty 1)	PK1-5MM-129
Sprung Hook 5.0-L (Qty 1)	PK1-5MM-130
Adjustment Tool T (Qty 1)	PK1-5MM-131
Flexible Adapter 5.0-L (Qty 1)	PK1-5MM-132
Safety Alligator Clip red (Qty 1)	PK1-5MM-133
Ground Lead 22 cm (Qty 1)	PK1-5MM-134

The PPE series includes four fixed-attenuation probes covering a range from 2 kV to 6 kV, and one switchable probe providing  $\div 10/\div 100$  attenuation for voltage inputs up to 1.2 kV. All fixed-attenuation, standard probes automatically rescale compatible Teledyne LeCroy oscilloscopes for the appropriate attenuation of the probe.

## PPE High-Voltage Probes Selection Guide Specifications

Types	Bandwidth (MHz)	Input R ( $\Omega$ )	Input C (pF)	Attenuation	Maximum Voltage	Probe Encoding	Cable
PPE4kV*	400	50 M	< 6	$\div 100$	4 kV	Yes	2 m
PPE5kV*	400	50 M	< 6	$\div 100$	5 kV	Yes	2 m
PPE6kV*	400	50 M	< 6	$\div 1000$	6 kV	Yes	2 m



Teledyne LeCroy  
High Voltage Probe  
Model Numbers:

**PPE4KV**  
**PPE5KV**  
**PPE6KV**

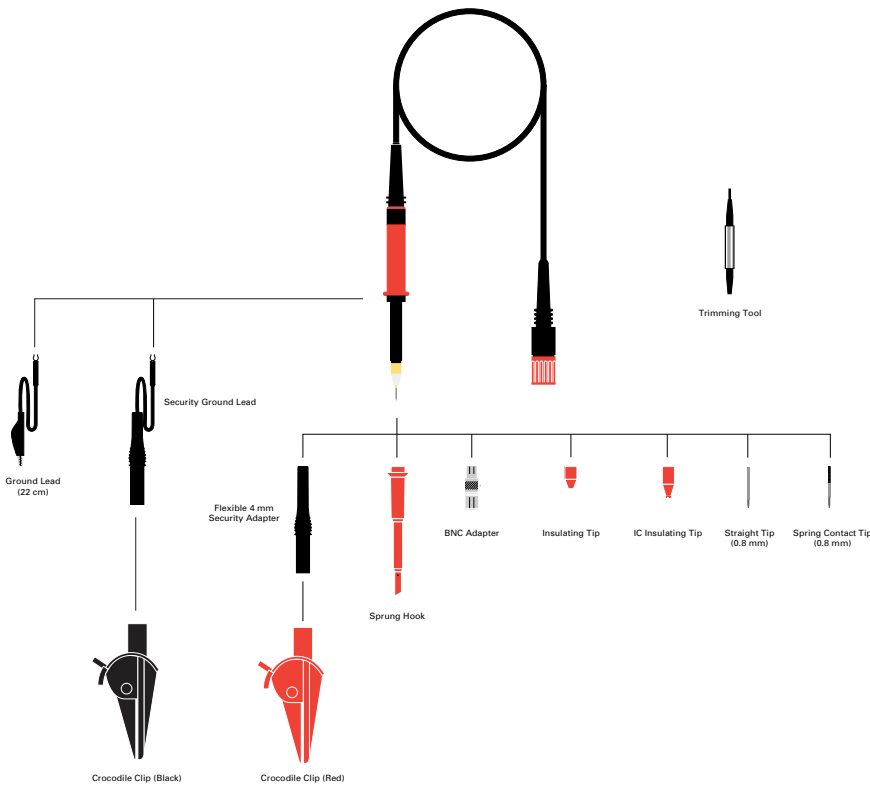

## Ordering Information

### Product Description

Product Description	Product Code
$\div 100$ ; 400 MHz; 50 M $\Omega$ High-Voltage Probe, 4 kV max. Voltage DC and Peak AC	PPE4KV
$\div 100$ ; 400 MHz; 50 M $\Omega$ High-Voltage Probe, 5 kV max. Voltage DC and Peak AC	PPE5KV
$\div 1000$ ; 400 MHz; 50 M $\Omega$ High-Voltage Probe, 6 kV max. Voltage DC and Peak AC	PPE6KV
Accessory Kit for PPE1.2kV, 2kV, 4kV, 5kV, and 6kV	PK103
Sprung Hook (red)	PK103-1
Ground Lead (22 cm)	PP005-GL22
Crocodile Clip	PK30x-2
Probe Tip to BNC Adapter	PP005-BNC
Sprung Tip (0.8 mm)	PP005-ST8
Rigid Tip V2A	PP005-RT

### Supplied with probe:

\* Probe Kit: Trimming tool, ground lead, rigid tip, IC insulator, BNC adapter, tip insulator, sprung hook, red crocodile clip, 4 mm safety ground lead, and green/yellow crocodile clip.

# HIGH VOLTAGE FIBER OPTICALLY-ISOLATED PROBES





# HIGH VOLTAGE FIBER OPTICALLY-ISOLATED PROBES

**The HVFO is an affordable, optimally designed probe for measurement of small signals floating on an HV bus in power electronics designs or for EMC, EFT, ESD, and RF immunity testing sensor monitoring. It far surpasses the measurement capabilities and signal fidelity of both conventional HV differential probes and acquisition systems that rely on galvanic high voltage isolation. Furthermore, it mitigates the need to rely on dangerous test setups that require floating the oscilloscope and probe.**

Teledyne LeCroy  
Probe Adapter  
Model Numbers:  
**HVFO103**

*Opposite page:  
High Voltage Fiber Optically-isolated Probe HVFO103 working  
with an HDO8000 High Definition Oscilloscope.*

# HIGH VOLTAGE FIBER OPTICALLY-ISOLATED PROBES



Teledyne LeCroy  
High Voltage Fiber  
Optically-isolated Probe  
Model Number:  
**HVF0103**

The HVFO is an affordable, optimally designed probe for measurement of small signals floating on an HV bus in power electronics designs or for EMC, EFT, ESD, and RF immunity testing sensor monitoring. It far surpasses the measurement capabilities and signal fidelity of both conventional HV differential probes and acquisition systems that rely on galvanic high voltage isolation. Furthermore, it mitigates the need to rely on dangerous test setups that require floating the oscilloscope and probe.

## Key Features

### Applications

- Upper-side gate drive signal measurements
- Floating control signal or sensor voltage measurements
- EMC, EFT, ESD, and RF immunity testing and system optimization
- Any small signal measurements with high common-mode voltage

**60 MHz bandwidth**

**35 kV common-mode voltage rating (fiber optic isolation)**

### Superior Noise and Rejection

- 140 dB CMRR
- Low loop inductance
- Low attenuation

**Reduced DUT loading, better pulse response compared to conventional HV differential probes**

**Selectable tips from  $\pm 1V$  to  $\pm 40V$**

**Eliminates need to “float” the oscilloscope**

**ProBus-compatible with many Teledyne LeCroy oscilloscopes**

# HIGH VOLTAGE FIBER OPTICALLY-ISOLATED PROBES

<b>Electrical</b>	
<b>Bandwidth</b>	60 MHz (typical, with tip attached)
<b>Rise Time (10-90%)</b>	7.5 ns (typical)
<b>Input Dynamic Range</b>	±1V, ±5V, ±20V, ±40V (DC+peak AC) respectively with 1X, 5X, 10X or 20X attenuating tips. All tips are purchased as accessories (none are included with HVFO103 probe).
<b>Maximum Non-destruct Voltage</b>	5 times the operating voltage rating (tip dependent)
<b>Common Mode Voltage Range</b>	±35 kV (DC+Peak AC) (not for hand-held use, user must maintain adequate spacing between floating probe components and earth ground.)
<b>Maximum Input Voltage to Earth</b>	±35 kV (DC+Peak AC) (not for hand-held use, user must maintain adequate spacing between floating probe components and earth ground.)
<b>Maximum Safe Input Voltage</b>	For hand-held use, 30 Vrms / 60 Vdc per IEC/EN 61010-031 Ed. 2.0 b:2015
<b>Offset</b>	Offset capability determined by oscilloscope offset available in a given gain (V/div) setting after accounting for total probe attenuation (total probe attenuation is twice the tip attenuation).
<b>Sensitivity</b>	50 mV/div to 1 V/div (1X tip), 250 mV/div to 5 V/div (5X tip), 1 V/div to 20 V/div (20X tip), 2 V/div to 40 V/div (40X tip)
<b>Gain Accuracy</b>	2% (LF, guaranteed)
<b>Input Impedance</b>	1 MΩ    34 pF (1X tip); 5 MΩ    26 pF (5X tip); 10 MΩ    22 pF (20X tip); 10 MΩ    22 pF (40X tip)
<b>Input/Output Coupling</b>	DC only
<b>Interface</b>	ProBus
<b>Cable Length</b>	1.25 m (4.1 feet) from input lead to oscilloscope connection (using included 1 meter fiber optic cable)
<b>Battery</b>	6 hour battery life (typical). 1.5 hour re-charge time (typical, with user-supplied dedicated USB charger). 3 hour re-charge time (typical) using supplied USB charging cable connected to oscilloscope USB port
<b>Noise and Rejection</b>	
<b>CMRR (typical)</b>	140 dB (100 Hz), 120 dB (to 1 MHz), 85 dB (to 10 MHz), 60 dB (to 60 MHz)
<b>Noise (Probe only)</b>	7 mVrms (1X tip), 35 mVrms (5X tip), 140 mVrms (20X tip), 280 mVrms (40X tip)
<b>Environmental</b>	
<b>Temperature</b>	0°C to 50°C (operating), -20°C to 70°C (non-operating)
<b>Humidity</b>	5% to 80% RH (non-condensing) up to 30°C, decreasing linearly to 45% RH at 50°C (operating) 5% to 95% RH (Non-Condensing), 75% RH above 30°C, 45% RH above 40°C (non-operating)
<b>Altitude</b>	3000 m (operating), 10,000 m (non-operating)
<b>Pollution Degree</b>	2, Indoor Use Only
<b>Certifications</b>	
<b>CE (LVD Directive 2006/95/EC)</b>	IEC/EN 61010-031/A1:2008, Pending IEC/EN 61010-031:2015
<b>CE (EMC Directive 2004/108/EC)</b>	IEC/EN 61326-1:2013
<b>uL Listed</b>	UL 61010-031 (First Edition), Pending UL 61010-031 (Second Edition)
<b>cUL Listed</b>	CAN/CSA - C22.2 No. 61010-031-07, Pending CAN/CSA-C22.2 No. 61010-031-15
<b>Compatibility</b>	
<b>Compatible With...</b>	Fully compatible with HDO4000 Series, HDO6000 Series, HDO8000 Series, MDA800 Series, HDO9000 Series, WaveRunner 8000 Series, WaveRunner 6 Zi Series, WavePro 7 Zi Series, and WaveMaster 8 Zi Series.

## Ordering Information

Product Description	Product Code
<b>High Voltage Fiber Optically-isolated Probe Models and Accessories</b>	
High Voltage Fiber Optic Probe, 60 MHz Bandwidth. Includes soft-carrying case, Qty. 1 Amplifier/Modulating Transmitter, Qty. 1 Demodulating Receiver, Qty. 1 1m Fiber Optic Cable, Qty. 1 USB Charging Cable, Qty. 1 Micro-gripper set. Attenuating Tips must be ordered separately.	HVFO103
±1V (1x) Attenuating Tip Accessory	HVFO100-1X-TIP
±5V (5x) Attenuating Tip Accessory	HVFO100-5X-TIP
±20V (20x) Attenuating Tip Accessory	HVFO100-20XTIP
±40V (40x) Attenuating Tip Accessory	HVFO100-40X-TIP
Spare Amplifier/Modulating Transmitter (permits constant operation - charge one while another is being used)	HVFO103-XMITTER
1m Spare Fiber Optic Cable Accessory	HVFO-1M-FIBER
2m Fiber Optic Cable Accessory	HVFO-2M-FIBER
6m Fiber Optic Cable Accessory	HVFO-6M-FIBER
NIST Traceable Calibration Certificate	HVFO103-CCNIST

# OPTICAL-TO-ELECTRICAL CONVERTERS



Teledyne LeCroy's wide-band multi-mode optical-to-electrical converters are designed for measuring optical communications signals. Their broad wavelength range and multi-mode input optics make these devices ideal for applications including Ethernet, Fibre Channel, and ITU telecom standards. Available to support optical data rates up to 11.3 Gb/s with reference receivers, or slightly higher without reference receivers.

These wide- band multi-mode optical-to-electrical converters are designed for measuring optical communications signals. They connect to Teledyne LeCroy real-time oscilloscopes and provide capability for physical layer signal assessment using a variety of oscilloscope tools, such as SDAIII-CompleteLinQ Serial Data Eye, Jitter, Noise and Crosstalk Analysis, mask testing, serial triggering and decoding, and other compliance and debug tools. Maximum data rate test capability is >11.317 Gb/s with reference receiver, or 12.5 Gb/s without.

Teledyne LeCroy  
Optical Probe  
Model Numbers:

OE6250G-M

OE695G

OE425

OE455

OE525

OE555

*Opposite page:  
OE6250G-M Optical Probe working with the LabMaster 10 Zi-A oscilloscope.*

# OPTICAL-TO-ELECTRICAL CONVERTERS

Teledyne LeCroy  
Optical Probe  
Model Numbers:

**OE6250G-M**  
**OE695G**  
**OE425**  
**OE455**  
**OE525**  
**OE555**



## OE6250G-M

The OE6250G optical-to-electrical converter enables optical signal measurement of intensity-modulated signals up to 28 Gbaud and beyond on LabMaster or WaveMaster series real-time oscilloscopes. As a fully calibrated module, the OE6250G-M integrates seamlessly into the oscilloscope software to give optical intensity measurement straight out of the box. Teledyne LeCroy's extensive tool-set includes powerful analysis tools for NRZ, PAM4, and other signal types, and enables custom signal processing and reference receiver implementation.

## Key Features

- Optical-to-electrical converter for intensity-modulated signals to 28 Gbaud and higher
  - Up to 25 GHz bandwidth with a 4th-order Bessel-Thomson frequency response
  - Up to 36 GHz bandwidth with a flat frequency response
- DC-coupled detector for accurate signal reproduction with a real-time oscilloscope
- Fully calibrated and integrated
- 50/125 μm multi-mode fiber input
- Ideal for Eye Mask, Extinction Ratio, and Optical Modulation Amplitude (OMA) testing

## OE6250G-M Specifications

	Typical
Analog Bandwidth	25 GHz (Bessel-Thomson response mode), 36 GHz (Flatness response mode)
Wavelength Range	830nm - 1600nm
Calibration Wavelengths	850nm, 1310nm, 1550nm
Conversion gain at 850nm	-80 V/W
Conversion gain at 1310nm	-125 V/W
Conversion gain at 1550nm	-125 V/W
Electrical output coupling	DC coupled
5% compression point at 1550nm	4 mW (minimum)
Noise measured up to 50GHz	500 uV RMS
Optical Return Loss	19 dB
Polarization dependent loss at 1550 nm	0.1 dB
RF impedance	50 Ω
Fiber (core/cladding)	50/125 μm
RF connector	2.92 mm
Optical Connector	FC/PC or SC/PC

Note: All specifications subject to change without notice.

# OPTICAL-TO-ELECTRICAL CONVERTERS



## OE695G

The OE695G wide-band optical-to-electrical converter is ideal for measuring optical datacom and telecom signals with data rates from 622 Mb/s to 12.5+ Gb/s. Connection to a real-time Teledyne LeCroy oscilloscope is through the 2.92 mm interface, with a provided adapter to connect to ProLink interfaces.

### Key Features

- Compatible with LabMaster 10 Zi oscilloscopes
- Frequency range DC to 9.5 GHz (electrical, -3 dB)
- Reference receiver support from 8GFC to 10GFC FEC, or Custom (<12.5Gb/s)
- Full bandwidth mode (no reference receiver applied)
- 62.5/125  $\mu\text{m}$  multi-mode or single-mode fiber input
- Broad wavelength range (750 to 1650 nm)
- +7 dBm (5 mW) max peak optical power
- Low noise (as low as 25 pW/√Hz)
- Ideal for Eye Mask, Extinction Ratio, and Optical Modulation Amplitude (OMA) testing

### Ordering Information

#### Product Description

Optical-to-Electrical Converter, DC to 36 GHz, 830 to 1600nm  
Optical-to-Electrical Converter, 785 to 1550 nm, 2.92 mm connector with ProLink adapter  
Optical-to-Electrical Converter, 500–870 nm ProBus BNC Connector  
Optical-to-Electrical Converter, 950–1630 nm ProBus BNC Connector  
Optical-to-Electrical Converter, 500–870 nm ProLink BMA Connector  
Optical-to-Electrical Converter, 950–1630 nm ProLink BMA Connector

#### Product Code

OE6250G-M  
OE695G  
OE425  
OE455  
OE525  
OE555



## OE425/OE455/OE525/OE555

The O/E converters contain calibration data that can be used to create optical reference receivers for SONET/SDH (up to OC48/STM16), Fibre Channel, Gigabit Ethernet, and other optical standards. This feature is available when the O/E is used on a supported oscilloscope. The universal reference receiver supports any data rate up to 3 GHz and remains calibrated on any channel of the oscilloscope.

### Key Features

- Frequency range to 5 GHz (6 GHz optical)
- 62.5  $\mu\text{m}$  or narrower multi-mode or single-mode fiber input
- Broad wavelength range:
  - 500–870 nm (OE425, OE525)
  - 950–1630 nm (OE455, OE555)
- High responsivity
- Low noise
- Included Accessories:
  - Multi-mode optical fiber jumper FC-FC
  - FC to ST adapter
  - FC to SC adapter

# PASSIVE PROBES

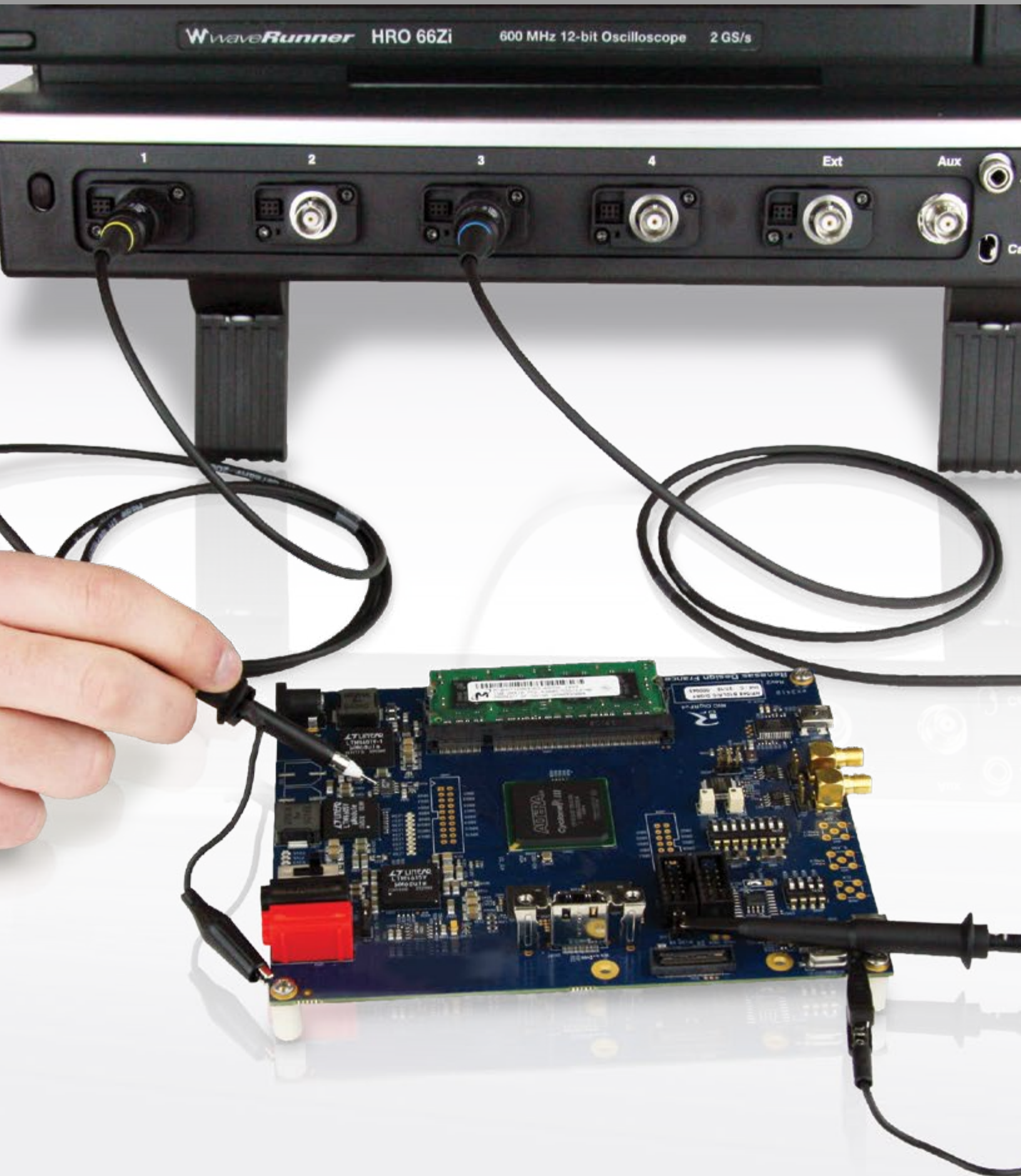



Passive probes are the standard probe provided with most oscilloscopes. Typical passive probes provide a  $\div 10$  attenuation and feature a high input resistance of 10 M $\Omega$ . This high input resistance means that passive probes are the ideal tool for low frequency signals since circuit loading at these frequencies is minimized. Passive probes are designed to handle voltages of at least 400 V, some as high as 600 V. Teledyne LeCroy passive probes feature an attenuation sense pin which tells the oscilloscope to scale the waveforms automatically requiring no user input.

Teledyne LeCroy  
Passive Probe  
Model Numbers:

PP006C  
PP016  
PP019  
PP020  
PP021  
PP022  
PP023  
PP024  
PP025  
PP026

# PASSIVE PROBES

Each passive probe is recommended for a certain oscilloscope, using the right passive probe with the right oscilloscope means that the probe can be properly compensated across the entire bandwidth. Using probes with a different oscilloscope will only let you compensate for low frequencies.

## Specifications

Types	Bandwidth	Input R	Input C	Attenuation	Maximum Voltage	Diameter
PP006C	500 MHz	10 MΩ	12 pF	÷10	500 V	5 mm
PP016	300 MHz/ 10 MHz	10 MΩ/ 1 MΩ	12 pF/ 46 pF	÷10/ ÷1	600 V	5 mm
PP019	200 MHz	10 MΩ	12 pF	÷10	500 V	5 mm
PP020	500 MHz	10 MΩ	11 pF	÷10	500 V	5 mm
PP021	500 MHz	10 MΩ	11 pF	÷10	500 V	2.5 mm
PP022	500 MHz	10 MΩ	10 pF	÷10	500 V	2.5 mm
PP023	500 MHz	10 MΩ	10 pF	÷10	500 V	2.5 mm
PP024	500 MHz	10 MΩ	10 pF	÷10	500 V	5 mm
PP025	500 MHz	10 MΩ	10 pF	÷10	500 V	5 mm
PP026	500 MHz	10 MΩ	10 pF	÷10	500 V	5 mm

Teledyne LeCroy  
Passive Probe  
Model Numbers:

- PP006C
- PP016
- PP019
- PP020
- PP021
- PP022
- PP023
- PP024
- PP026

**Passive Probe Accessories for PP006C**  
Replacement Part Kit: PK116

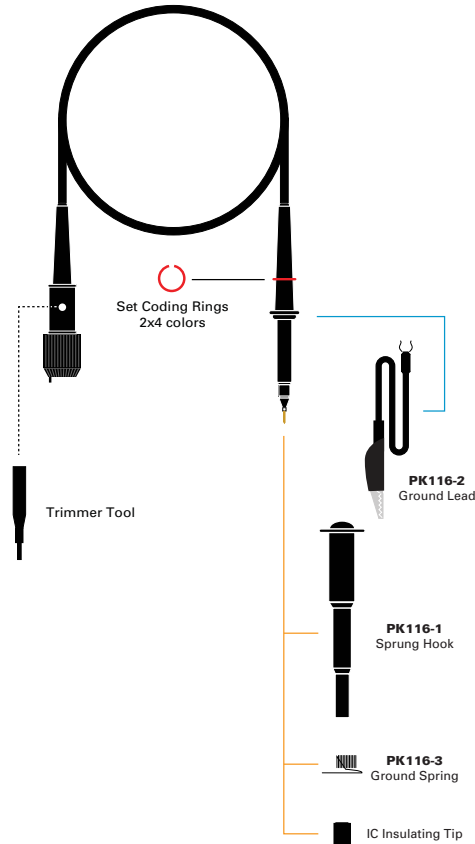

**Passive Probe Accessories for PP016**  
Replacement Part Kit: PKIT3-5MM-101

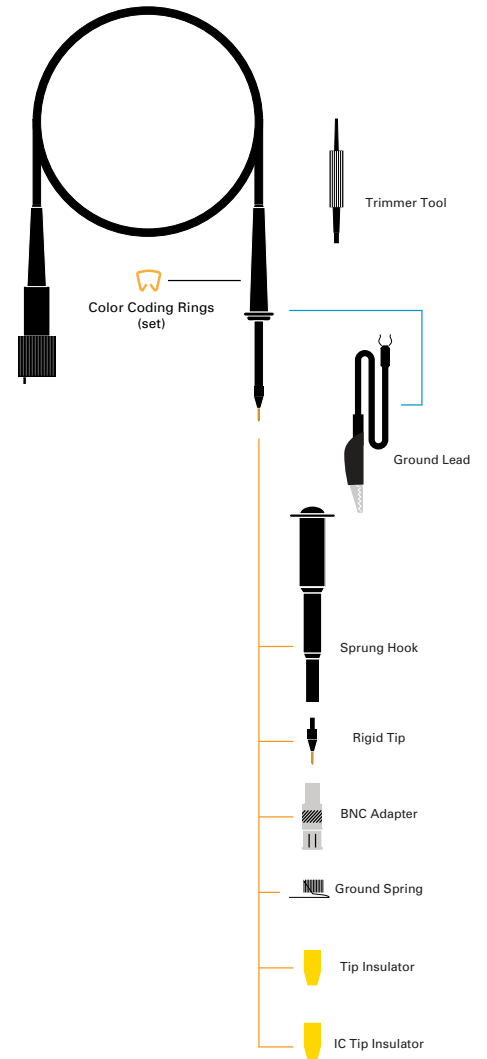

## Passive Probe Accessories for

PP019 and PP020 – Part numbers in blue

Replacement Part Kit: PKIT4-5MM-101

PP024, PP025, and PP026 – Part numbers in gray

Replacement Part Kit: PKIT6-5MM-101

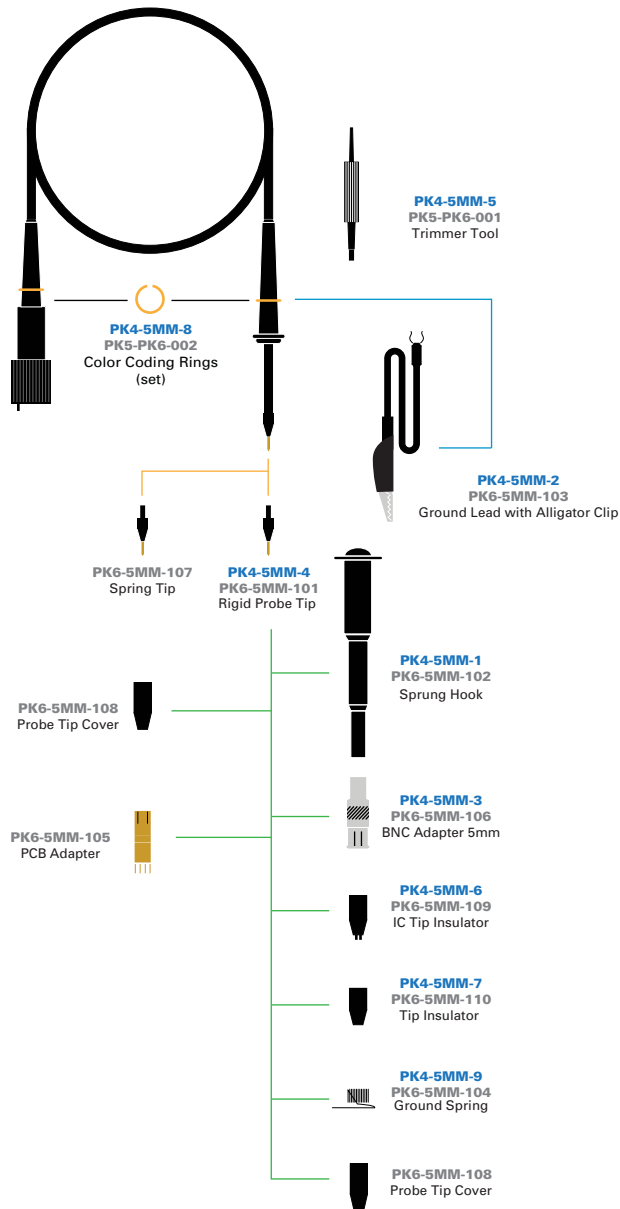

## Passive Probe Accessories for

PP021, PP022, and PP023

Replacement Part Kit: PKIT5-2.5MM-101

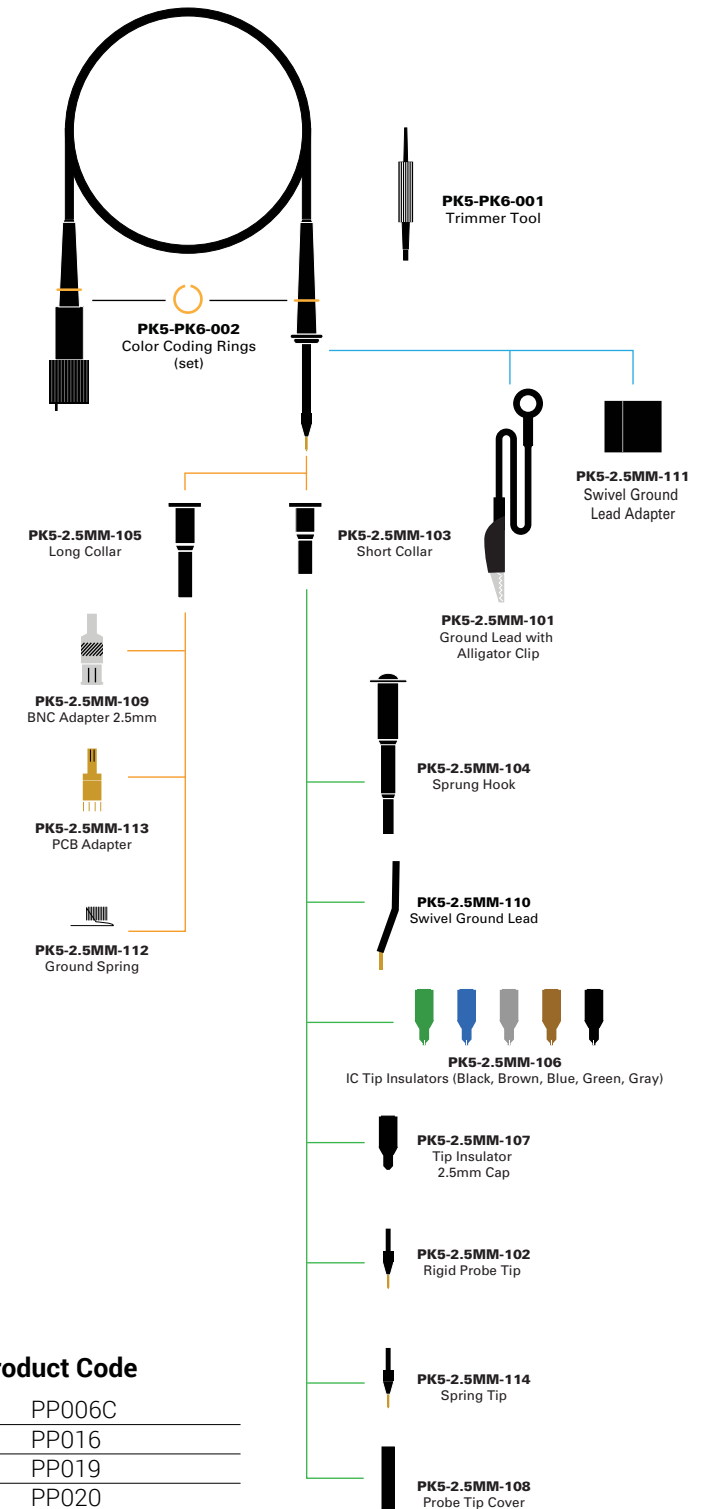

## Ordering Information

### Product Description

500 MHz Passive Probe for WaveJet Touch, 10:1, 10 MΩ

10:1, 10 MΩ, 300 MHz Passive Probe

250 MHz Passive Probe for WaveSurfer 3000, 10:1, 10 MΩ

500 MHz Passive Probe for WaveSurfer 3000, 10:1, 10 MΩ

500 MHz Passive Probe, 2.5mm, 10:1, 10 MΩ

500 MHz Passive Probe, 2.5mm, 10:1, 10 MΩ

500 MHz Passive Probe, 2.5mm, 10:1, 10 MΩ

500 MHz Passive Probe, 5mm, 10:1, 10 MΩ

500 MHz Passive Probe, 5mm, 10:1, 10 MΩ

500 MHz Passive Probe, 5mm, 10:1, 10 MΩ

### Product Code

PP006C

PP016

PP019

PP020

PP021

PP022

PP023

PP024

PP025

PP026

# PROBE ADAPTERS



Teledyne LeCroy  
Probe Adapter  
Model Numbers:  
**CA10**  
**TPA10**

## Key Features

- Provides ability for third party current sensor to operate like a Teledyne LeCroy probe
- Programmable EEPROM for saving third party current sensor parameters
- Allows for addition of shunt resistor and RLC filter components
- ProBus Active interface with automatic scaling in A/div
- Easy to use, saves time and possible errors

Probe adapters provide simple and easy interface of third-party probes as well as change between the different Teledyne LeCroy Oscilloscope input and cable types (ProBus, ProLink, K/2.92 mm, BNC and SMA). Depending on the adapters, changing between the Teledyne LeCroy Oscilloscope's input type may have an effect on the overall performance of the channel.



## CA10

The CA10 is a programmable and customizable interface device that seamlessly incorporates third party current transducers/transformers with Teledyne LeCroy oscilloscopes or motor drive analyzers. The easy to use interface provides the ability for the CA10 to be programmed to contain the specifications of the current sensor allowing it to automatically correct for the gain or attenuation and display results in Ampere units. This allows the third party device to be recognized and operate as if it were a Teledyne LeCroy probe.

## Specifications

Input Coupling	DC, AC, Both
Input Termination	1M $\Omega$ or 50 $\Omega$
Programmable Bandwidth Filters	Full, 200 MHz, 20 MHz
Transformer/Transducer Interface	BNC
Scaling Factors	Programmable
Resistive Termination (if required)	Customizable (See Operator's Manual for details)
Oscilloscope Interface	Teledyne LeCroy ProBus

*Note: Some third party devices will require a separate power supply or batteries. The CA10 does not have the ability to supply the power to these devices.*

## Ordering Information

Product Description	Product Code
ProBus Current Sensor Adapter	CA10
Set of 4 CA10, ProBus Current Sensor Adapter	CA10-QUADPAK

### Included with Standard Configuration CA10

Description	Qty
CA10 ProBus Current Adapter	1
Heat-Shrink tubing (6" length)	1
Removable Labels (sheet of 20)	1

# PROBE ADAPTERS



## TPA10

The TPA10 ProBus™ Probe Adapter enables you to connect select TekProbe interface level II probes to any ProBus-equipped Teledyne LeCroy instrument. The TPA10 supplies all necessary power and offset control to the probe and automatically detects which probe is attached.

## Specifications

### Electrical Characteristics

Bandwidth	4 GHz (adapter only)
Power Supplies	+15V, -15V, +5V, -5V (each 2%)
Offset Voltage	±1V (1%)
Max. Input Voltage	47 V <sub>pk</sub> , 33 V <sub>rms</sub>

### Environmental

Operating Temperature Range	0 to 50 °C
Non-operating Temperature Range	-40 to +70 °C
Humidity	5% to 95% RH (10 to 40 °C); 5% to 75% (above 40 °C); RH not controlled below 10 °C
Operating Altitude	3000 meters maximum

### Physical

Dimensions (WxHxD)	39 mm x 31.1 mm x 88.6 mm (1.54" x 1.22" x 3.49")
Weight	119 g (0.26 lb)

The TPA10 requires the Teledyne LeCroy oscilloscope to be running firmware version 7.8.0.0 or greater.

## Key Features

- Allows TekProbe™ interface level II probes to work with any ProBus-equipped Teledyne LeCroy oscilloscope
- Automatic probe detection
- Provides all necessary power and offset control to the attached probe
- Supports probes up to 4 GHz
- Easy firmware updates
- Wide variety of probes supported including:
  - Preamplifiers
  - Current Probes
  - Single-Ended Active Probes
  - Differential Active Probes

## Ordering Information

Product Description	Product Code
TPA10 ProBus Adapter	TPA10
Set of 4 TPA10, TPA10 ProBus Adapters	TPA10-QUADPAK

### Supported Probes

The following TekProbe devices are supported for use with TPA10:

#### Preamplifiers

1 MHz Differential Preamplifier	ADA400A
---------------------------------	---------

#### Current Probes

50 MHz AC/DC Current Probe	TCP202/TCP202A
----------------------------	----------------

#### Single-ended Active Probes

750 MHz Single-ended Active Probe	P6205
1 GHz Single-ended Active Probe	P6243
1.5 GHz Single-ended Active Probe	P6245
4 GHz Single-ended Active Probe	P6241
4 GHz Single-ended Active Probe	P6249

#### Differential Active Probes

100 MHz Differential Probe	P5205/P5205A
50 MHz Differential Probe	P5210/P5210A
400 MHz Differential Probe	P6246
1 GHz Differential Probe	P6247
1.5 GHz Differential Probe	P6248
500 MHz Differential Probe	P6250
1 GHz Differential Probe	P6251

# TRANSMISSION LINE PROBES

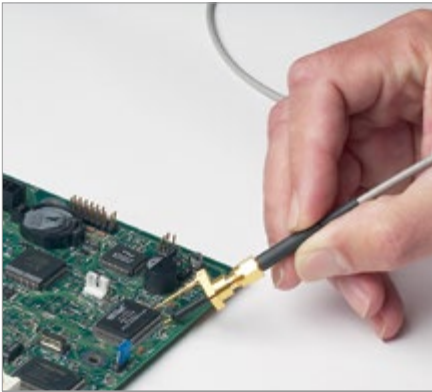

Teledyne LeCroy  
Transmission Line Probe  
Model Number:  
PP066

Transmission line probes are a special type of passive probe designed for use at very high frequencies. They replace the high impedance probe cable found in a traditional passive probe with a precision transmission line, with a characteristic impedance that matches the oscilloscope input ( $50 \Omega$ ). This greatly reduces the input capacitance to a fraction of a picofarad, minimizing the loading of high frequency signals. A matching network at the tip increases the DC input resistance. While they have lower DC input resistance than a traditional passive probe (usually  $500 \Omega$  to  $5 \text{ k}\Omega$ ), the input impedance of these probes remains nearly constant over their entire frequency range. A traditional  $\div 10$  passive probe will have a  $10 \text{ M}\Omega$  input impedance at DC, however this impedance drops rapidly with frequency, passing below the input impedance of a transmission line probe at less than  $100 \text{ MHz}$ .

In some applications, transmission line probes offer advantages over active probes. In addition to being less expensive, their passive design is more robust to over voltage and ESD exposure. They are useful in applications producing fast rising, narrow pulses with amplitudes which exceed the dynamic range of active probes. They also tend to have less parasitic effects on frequency response.

## PP066

The PP066 is a high-bandwidth passive probe designed for use with the WaveMaster and other high-bandwidth oscilloscopes with 50  $\Omega$  input termination. This very low capacitance probe provides an excellent solution for higher frequency applications, especially the probing of transmission lines with 20–100  $\Omega$  impedance. The PP066 accommodates a wide range of applications, including probing of analog and digital ICs commonly found in computer, communications, data storage, and other high-speed designs.

### Key Features:

- Interchangeable attenuator tips
- Signal integrity at high bandwidth
- Standard SMA cable connection
- Ultra low capacitance

## PP066 Specifications

### Electrical Characteristics

Bandwidth	DC to 7.5 GHz
Risetime	< 47 ps
Input Capacitance	< 0.20 pF
Input Resistance	500 $\Omega$ ( $\div 10$ cartridge) 1000 $\Omega$ ( $\div 20$ cartridge)
Maximum Voltage	15 V rms
Cable Length	1 m

## Ordering Information

### Product Description

7.5 GHz Low Capacitance Passive Probe  
( $\div 10$ , 1 k $\Omega$ ;  $\div 20$ , 500  $\Omega$ )

### Product Code

PP066

### Included with PP066

PACC-AD001, SMA to BNC Adapter





**1-800-5-LeCroy**  
**teledynelecroy.com**

**Local sales offices are located throughout the world.**  
**Visit our website to find the most convenient location.**