

FRONT VIEW

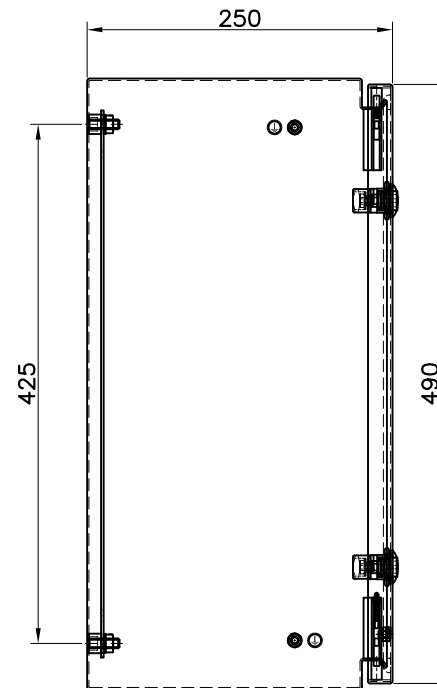

SIDE VIEW

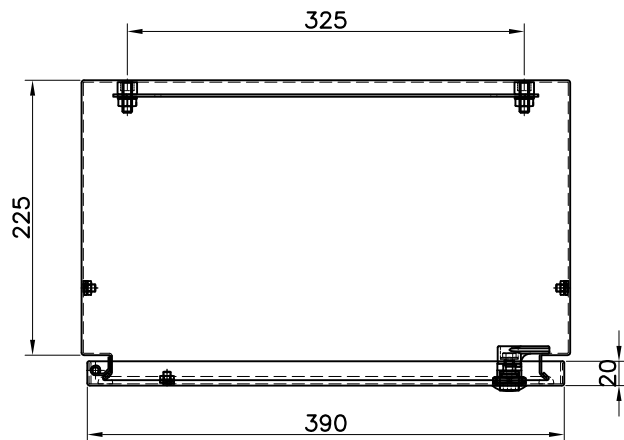

TOP VIEW

ALL DIMENSIONS ARE IN MILLIMETRES

No.	Revision note	Edit	Date



Date 16-01-2012	Material 1.5mm S.S(AISI 304)	Finish NATURAL, CLEAN	Scale N.T.S.
STAINLESS STEEL BOX IP66 400x500x250			
Ord. No. 7491844	Sheet A4	Tolerances ±0.2	