

STRICTLY CONFIDENTIAL

SECTION A-A

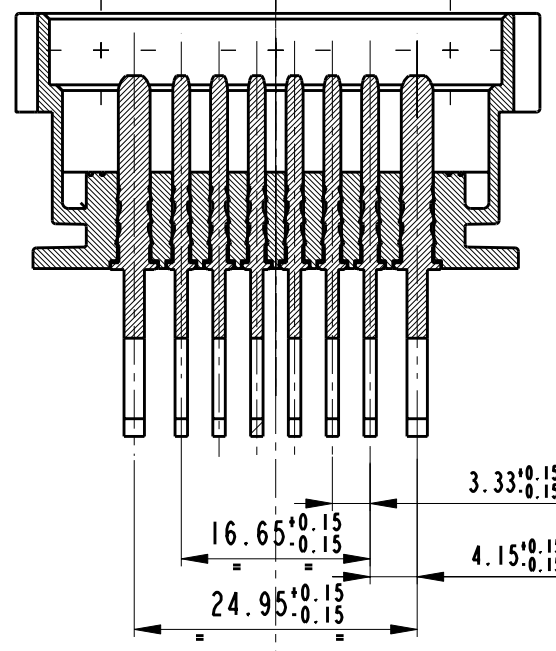

3.33^{+0.15}_{-0.15} TOL NOT CUMULATIVE
 16.65^{+0.15}_{-0.15}
 24.95^{+0.15}_{-0.15}
 4.15^{+0.15}_{-0.15} TOL NOT CUMULATIVE

KEY CODE
"BLACK" COLOUR

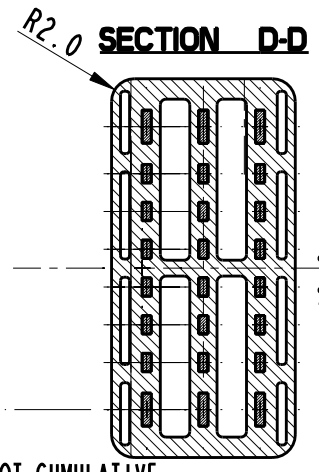

⊕	0.55	A
⊕	0.65	A
⊕	0.75	A

N° 18 CONTATTI 15 x 0.8
N° 18 CONTACTS 15 x 0.8
N° 6 CONTATTI 28 x 0.8
N° 6 CONTACTS 28 x 0.8

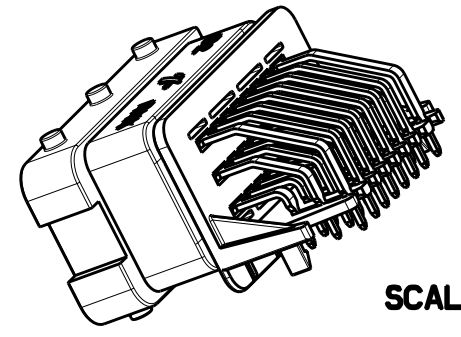
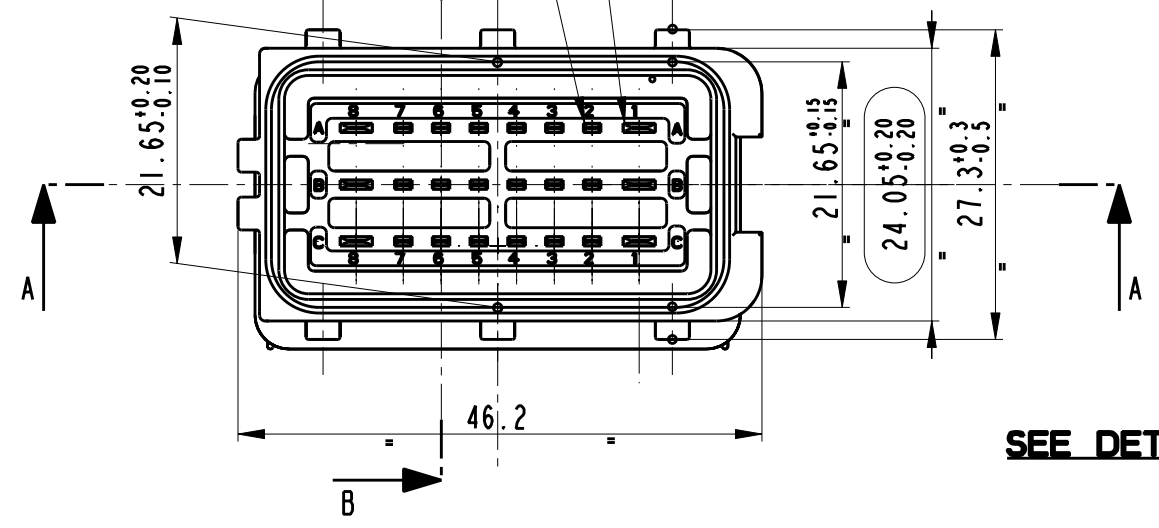

SCALE 1:1

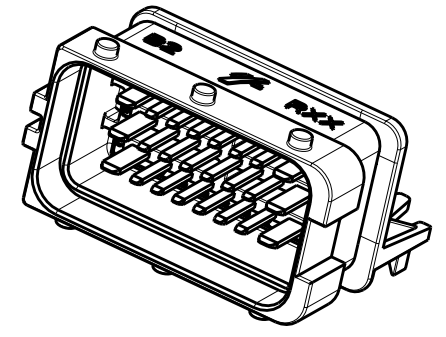

SEE DETAIL X

SECTION B-B

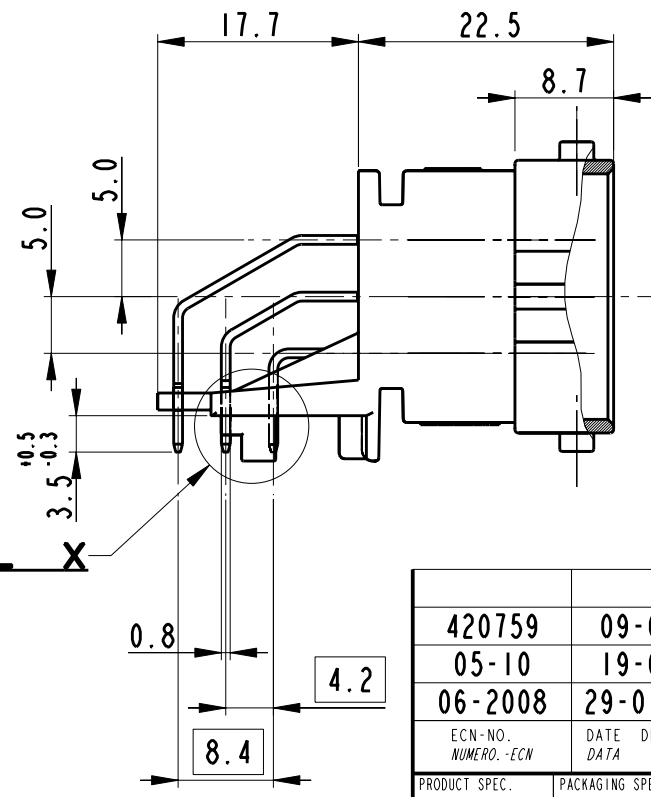

SCALE 15:1

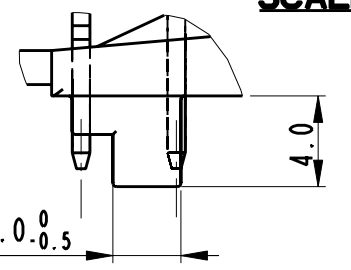

NOTE

- 1 HOUSING RAW MATERIAL: PBT 15 GLASS FIBER
HOUSING TENSILE MODULUS: 5600 MPa at 20°C
- 2 CONTACTS RAW MATERIAL; CuZn37; TIN OR GOLD PLATING
- 3 PRODUCT ACCORDING TO PSA SPECIFICATION: 9604596299
- 4 KEY CODE GREY-BROWN NOT SHOWN

○ CAPABILITY

420759	09-01-13	A		ADDED DELPHI P/N	D.T.	JMH	L.E.		
05-10	19-03-10	12		ADDED TENSILE MODULUS NOTE	D.T.		M.C.		
06-2008	29-01-2008	11		ADDED P/N FOR GOLD VERSION (SHEET 2)	F.G.		M.C.		
ECN-NO. NUMERO - ECN	DATE DATA	DD / MM / YY	REVISION REVISIONE	POSITION POSIZIONE	CHANGE DESCRIPTION DESCRIZIONE MODIFICA		DRAWN BY DISEGNATORE	CHK. BY CONTROLLATO	APPR. BY APPROVATO
PRODUCT SPEC. SPEC. DI PRODOTTO	PACKAGING SPEC. SPEC. DI IMBALLAGGIO	APPLICATION SPEC. SPEC. DI APPLICAZIONE		COPYRIGHT DELPHI CORPORATION AND/OR ITS AFFILIATES. ALL RIGHTS RESERVED. REVISED THIS DRAWING IS THE PROPERTY OF DELPHI CORPORATION. THE REPRODUCTION, DISTRIBUTION AND UTILIZATION OF THIS DOCUMENT OR ITS RELATED CAD MATH DATA, AS WELL AS COMMUNICATION OF ANY CONTENT TO OTHERS, WITHOUT EXPRESS AUTHORIZATION IS PROHIBITED.					
TOLERANCES TOLLERANZE	± 0.3 mm / ± 1°	MATERIAL : MATERIALE :		SURFACE FINISH FINITURA SUPERFICIALE		DELPHI DELPHI PACKARD ELECTRICAL/ELECTRONIC ARCHITECTURE TORINO, ITALY		CAD SYSTEM	
COUNTERPART Nr. CONTROPARTE Nr.		SEE SHEET 1				C		pro / eng.	
DO NOT SCALE DRAWING DISEGNO FUORI SCALA		SEE SHEET 2		LOC. CODE NAZIONALITA' IT		DIMENSION IN MILLIMETERS DIMENSIONI IN MILLIMETRI		DWG SIZE FORMATO	
DRAWN BY DISEGNATORE	DATE DATA	NAME NOME	TITLE DESCRIZIONE	DRAWING NUMBER NUMERO DISEGNO		DRAWING NUMBER NUMERO DISEGNO		SHEET FOGLIO	
CHECKED BY CONTROLLATO	06-12-02	R. Rampone		FILE NAME NOME FILE		DRAWING NUMBER NUMERO DISEGNO		of / di	
APPROVED BY APPROVATO	06-12-02	T. Ciriello		FSC 308654		DRAWING NUMBER NUMERO DISEGNO		2	
				24 WAY RECEPTACLE 90°		FSC308654		SCALE SCALA	
				CAT. NO. NUMERO CAT. SEE SHEET 2		FSC308654		3:2	

