

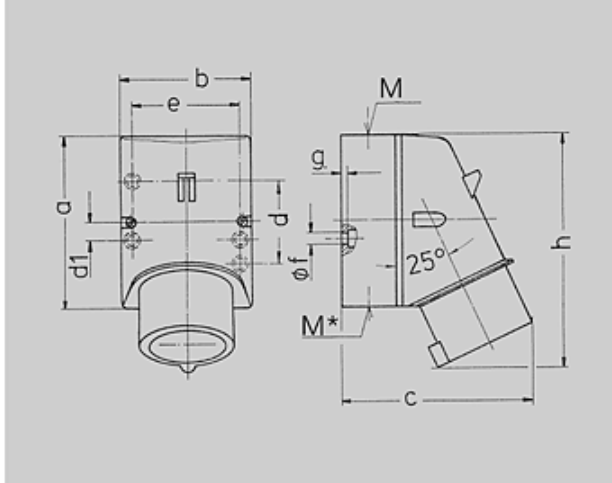

Part no. : 332

Wall mounted inlet

Cable entry facility also from the rear by use knock outs.



Drawing	Amp.	16			32		
		Poles			3	4	5
Dim. in mm	a	87	100	100	128	128	128
	b	64	75	75	84	84	84
	c	93	106	110	133	133	135
	d	40	—	—	—	—	—
	d1	—	10,5	10,5	11	11	11
	e	50,5	59	59	68	68	68
	f	4,5	5	5	5,3	5,3	5,3
	g	4	4	4	4	4	4
	h	122	133	135	169	169	170
	M	20	20	20	25	25	32
	M*	M 20 (blind) to be cut out			M 25 (blind) to be cut out		
	Max. cabel diam. (mm)	13	18	18	25	25	25
	Terminal for cond. cross section (mm ²) min.-max.	1 —2,5	1 —2,5	1 —2,5	2,5 —6	2,5 —6	2,5 —6

 Article-group : **2045**

voltages : 230V

rated current : 16A

pole : 3 pole







IP protection types : IP44

position of ground contact : 6h

packing unit : 0010

weight : 150 g

PART NUMBERS

	V	110V	230V	400V	500V	>50-500V	
	Hz	50,60	50,60	50,60	50,60	100-300	300-500
	colour						
	amp.						
16 A	3	331	332	333			
	4	334	335	336	337	921	922
	5	340	341	342	2359	2668	2400
32 A	3	343	344	345			
	4	346	347	348	349		
	5	352	353	354	2386		