

Waterproof Circular Connectors Conforming to European Safety Standards

CE05 Series



Conforming Standard
MIL-DTL-5015

Waterproof
IP 67

Lock Type
Threaded Coupling

Safety Standard
TÜV, UL



◆ OUTLINE

The industrial machinery including the machine tools which is exported to Europe has to conform with European safety standards since January, 1995. The CE05 series connectors, which offer full compatibility with MIL-C-5015, D/MS and CE02 series connectors, were developed to comply with this demand.

◆ FEATURES

- European Safety Standard
CE05 series fully conforms with the connector standard of EN61984 (DIN VDE0627) which is in accordance with European standard of EN60204-1 for the safety of machinery and electrical equipment for machines. Our products have been approved by TÜV Rheinland.
- UL
CE05 has been approved by UL (Underwriters Laboratories Inc.) in the USA who is an independent product safety certification organization
- First Make –Last Break Ground Contact to Protect Circuit
Connectors have a pre-mating ground contact having conductivity with the shell to protect a circuit. The pre-mating contact will mate with the mating half contact first on mating the connectors and will unmate last on unmating the connectors. The connectors provide a path for any stray voltage to be shunted to a safe ground avoiding harm to the operator and the voltage sensitive equipment.
- Water/Oil/Dust Structure – Class IP67 Protection
Class IP67 protection in the mated condition. CE05-2A receptacle connectors are IP67 rated in the unmated condition since these connectors have the pin contacts in the rubber inserts.



◆ MATERIAL / FINISH



Item	Material / Finish
Contact	Copper Alloy / Silver Plating
2A Style Pin Front Insert	Synthetic Rubber / Black
2A Style Pin Rear Insert	Synthetic Resin / Black
2A Style Socket Insert	Synthetic Resin / Black
6A Style Socket Insert	Synthetic Resin / Black
6A Style Pin Insert	Synthetic Resin / Black
Shell	Aluminum Alloy / Zinc Plating, Black Trivalent Chromium Treatment
Coupling Ring	Aluminum Alloy / Zinc Plating, Black Trivalent Chromium Treatment
Retaining Ring	Copper Alloy / Nickel Plating
Earth Rag	Copper Alloy / Silver Plating
Gasket	Synthetic Resin / Black

◆ SPECIFICATIONS

Current Rating	Contact Size	# 16	# 12	# 8	# 4
	Maximum Rating per Contact	13A	23A	46A	80A
Rated Voltage	2000V ~ 3000V AC(r.m.s.) at 1minute				
Insulation Resistance	5000M Ω (Min.) at 500V DC				
Operating Temperature	-55°C to 125°C				
Waterproof Rating	IP67				

Receptacle Connector

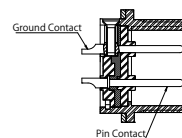

Plug Connector

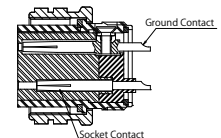

Certification Organization	Safety Standard	Certificate Number
TÜV	DIN VDE 0627 (EN61984)	Refer to page 3
UL	UL 1977	E72124

◆ APPLICABLE CABLE SIZE

Contact		Applicable Cable Size		
Size	Minimum Bore of Solder Cup	AWG Size	Nominal Sectional Area	Maximum Conductor Dia.
# 16	φ 1.76	# 22 ~ # 16	1.25mm ²	1.6mm
# 12	φ 2.70	# 14 ~ # 12	3.50mm ²	2.5mm
# 8	φ 4.70	# 10 ~ # 8	8.00mm ²	4.5mm
# 4	φ 7.50	# 8 ~ # 6	22.00mm ²	7.0mm

© Specifications and/or dimensions in this catalog are subject to change without notice.
Your checking the latest specifications with our drawings would be highly appreciated.

▶ CE05 Part Number

Insert Arrangement	Part Number		Backshell Style	Waterproof Cable Clamp or Conduit
	Receptacle	Plug		
10SL-3	CE05-2A10SL-3PC-D	CE05-6A10SL-3SC-D	Without Backshell	Conduit
		CE05-6A10SL-3SC-D-BSS	Straight Backshell	CE3057-4A-1-D
		CE05-8A10SL-3SC-D-BAS	Angle Backshell	
14S-2	CE05-2A14S-2PD-D	CE05-6A14S-2SD-D	Without Backshell	Conduit
		CE05-6A14S-2SD-D-BSS	Straight Backshell	CE3057-6A-1-D
18-10	CE05-2A18-10PD-D	CE05-6A18-10SD-D	Without Backshell	Conduit
		CE05-6A18-10SD-D-BSS	Straight Backshell	CE3057-10A-□-D
		CE05-8A18-10SD-D-BAS	Angle Backshell	
	CE05-2A18-10SD-D	CE05-6A18-10PD-D	Without Backshell	Conduit
		CE05-6A18-10PD-D-BSS	Straight Backshell	CE3057-10A-□-D
		CE05-8A18-10PD-D-BAS	Angle Backshell	
18-12	CE05-2A18-12PD-D	CE05-6A18-12SD-D	Without Backshell	Conduit
		CE05-6A18-12SD-D-BSS	Straight Backshell	CE3057-10A-□-D
		CE05-8A18-12SD-D-BAS	Angle Backshell	
20-4	CE05-2A20-4PD-D	CE05-6A20-4SD-D	Without Backshell	Conduit
		CE05-6A20-4SD-D-BSS	Straight Backshell	CE3057-12A-□-D
		CE05-8A20-4SD-D-BAS	Angle Backshell	
	CE05-2A20-4SD-D	CE05-6A20-4PD-D	Without Backshell	Conduit
		CE05-6A20-4PD-D-BSS	Straight Backshell	CE3057-12A-□-D
		CE05-8A20-4PD-D-BAS	Angle Backshell	
20-15	CE05-2A20-15PD-D	CE05-6A20-15SD-D	Without Backshell	Conduit
		CE05-6A20-15SD-D-BSS	Straight Backshell	CE3057-12A-□-D
		CE05-8A20-15SD-D-BAS	Angle Backshell	
	CE05-2A20-15SD-D	CE05-6A20-15PD-D	Without Backshell	Conduit
		CE05-6A20-15PD-D-BSS	Straight Backshell	CE3057-12A-□-D
		CE05-8A20-15PD-D-BAS	Angle Backshell	
20-18	CE05-2A20-18PDE-D	CE05-6A20-18SDE-D	Without Backshell	Conduit
		CE05-6A20-18SDE-D-BSS	Straight Backshell	CE3057-12A-□-D
		CE05-8A20-18SDE-D-BAS	Angle Backshell	
22-22	CE05-2A22-22PD-D	CE05-6A22-22SD-D	Without Backshell	Conduit
		CE05-6A22-22SD-D-BSS	Straight Backshell	CE3057-12A-□-D
		CE05-8A22-22SD-D-BAS	Angle Backshell	
	CE05-2A22-22SD-D	CE05-6A22-22PD-D	Without Backshell	Conduit
		CE05-6A22-22PD-D-BSS	Straight Backshell	CE3057-12A-□-D
		CE05-8A22-22PD-D-BAS	Angle Backshell	
22-23	CE05-2A22-23PD-D	CE05-6A22-23SD-D	Without Backshell	Conduit
		CE05-6A22-23SD-D-BSS	Straight Backshell	CE3057-12A-□-D
		CE05-8A22-23SD-D-BAS	Angle Backshell	
	CE05-2A22-23SD-D	CE05-6A22-23PD-D	Without Backshell	Conduit
		CE05-6A22-23PD-D-BSS	Straight Backshell	CE3057-12A-□-D
		CE05-8A22-23PD-D-BAS	Angle Backshell	
24-10(D)	CE05-2A24-10PD-D	CE05-6A24-10SD-D	Without Backshell	Conduit
		CE05-6A24-10SD-D-BSS	Straight Backshell	CE3057-16A-□-D
		CE05-8A24-10SD-D-BAS	Angle Backshell	
24-10(G)	CE05-2A24-10PG-D	CE05-6A24-10SG-D	Without Backshell	Conduit
		CE05-6A24-10SG-D-BSS	Straight Backshell	CE3057-16A-□-D
		CE05-8A24-10SG-D-BAS	Angle Backshell	
24-11	CE05-2A24-11PGH-D	CE05-6A24-11SGH-D	Without Backshell	Conduit
		CE05-6A24-11SGH-D-BSS	Straight Backshell	CE3057-16A-□-D
		CE05-8A24-11SGH-D-BAS	Angle Backshell	
32-17	CE05-2A32-17PD-D	CE05-6A32-17SD-D	Without Backshell	Conduit
		CE05-6A32-17SD-D-BSS	Straight Backshell	CE3057-20A-□-D
		CE05-8A32-17SD-D-BAS	Angle Backshell	
	CE05-2A32-17SD-D	CE05-6A32-17PD-D	Without Backshell	Conduit
		CE05-6A32-17PD-D-BSS	Straight Backshell	CE3057-20A-□-D
		CE05-8A32-17PD-D-BAS	Angle Backshell	

*If you use the conduit, please ask conduit supplier.

▶ Insert Arrangement

Number of Contact	3	4	4	6
Insert No.	10SL-3	14S-2	18-10	18-12
Insert Arrangement				
Reverse Contact	n/a	n/a	Available	n/a
Contact Size	# 16	# 16	# 12	# 16
Ground Contact	C	D	D	D
Rated Voltage	AC200V (r.m.s.)	AC200V (r.m.s.)	AC250V (r.m.s.)	AC250V (r.m.s.)
Dielectric Withstanding Voltage	AC2,000V (r.m.s.)	AC2,000V (r.m.s.)	AC3,000V (r.m.s.)	AC2,000V (r.m.s.)
Current Capacity	13A (29.2A)	13A (35.3A)	23A (62.5A)	13A (73.6A)
TÜV Certificate No.	R50082122	R50082122	R50082065	R50082122

Number of Contact	4	7	3 / 6	4
Insert No.	20-4	20-15	20-18	22-22
Insert Arrangement				
Reverse Contact	n/a	Available	n/a	Available
Contact Size	# 12	# 12	# 12 # 16	# 8
Ground Contact	D	D	D, E	D
Rated Voltage	AC250V (r.m.s.)	AC250V (r.m.s.)	AC250V (r.m.s.)	AC250V (r.m.s.)
Dielectric Withstanding Voltage	AC2,800V (r.m.s.)	AC2,000V (r.m.s.)	AC2,000V (r.m.s.)	AC3,000V (r.m.s.)
Current Capacity	23A (62.5A)	23A (83.7A)	#12 : 23A #16 : 13A(67.6A)	46A (125.1A)
TÜV Certificate No.	R50082065	R50082065	R50082065	R50082069

Number of Contact	8	7	7	3 / 6	4
Insert No.	22-23	24-10 (D)	24-10 (G)	24-11	32-17
Insert Arrangement					
Reverse Contact	Available	n/a	n/a	n/a	Available
Contact Size	# 12	# 8	# 8	# 8 # 12	# 4
Ground Contact	D	D	G	G, H	D
Rated Voltage	AC250V (r.m.s.)	AC250V (r.m.s.)	AC250V (r.m.s.)	AC250V (r.m.s.)	AC250V (r.m.s.)
Dielectric Withstanding Voltage	AC2,000V (r.m.s.)	AC2,000V (r.m.s.)	AC2,000V (r.m.s.)	AC2,000V (r.m.s.)	AC2,800V (r.m.s.)
Current Capacity	23A (90.1A)	46A (167.4A)	46A (167.4A)	# 8 : 46A #12 : 23A(126.4A)	80A (217.6A)
TÜV Certificate No.	R50082065	R50082069	R50082069	R50082069	R50082124

* Front view of pin contact and standard key position

* The sign "●" stands for the ground contact.

* Current capacity shows the maximum permitted current per contact.

Values in parenthesis show the total current capacities in each one of respective connectors.

* n/a stands for "not available".

▶ Alternate Insert Position

Insert No.	Number of Contact	Alternate Insert Position			
		W	X	Y	Z
10SL-3	3				
14S-2	4		120°	240°	
18-10	4		120°	240°	
18-12	6	80°			280°
20-4	4	45°	110°	250°	
20-15	7	80°			280°
20-18	9				
22-22	4		110°	250°	
22-23	8	35°			
24-10	7	80°			280°
24-11	9				
32-17	4	45°	110°	250°	

To avoid cross-mating problems in applications requiring the use of more than one connector of the same size and insert arrangement, alternate insert positions are available as indicated or as shown in the diagram below.

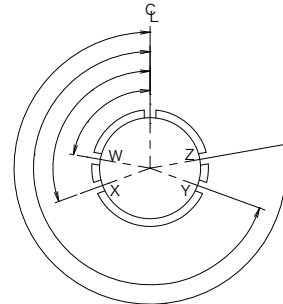

Front View of Pin Insert
(Rear View of Socket Insert)

☆ The safety standard, VDE, is applied only to the equipment which uses more than 60V DC. It is not applied to the insert arrangements of 20-29 or 22-14 which are used for signal transmission.

In the case of using 20-29 and 22-14 CE02 series and D/MS series are available.

▶ Configuration

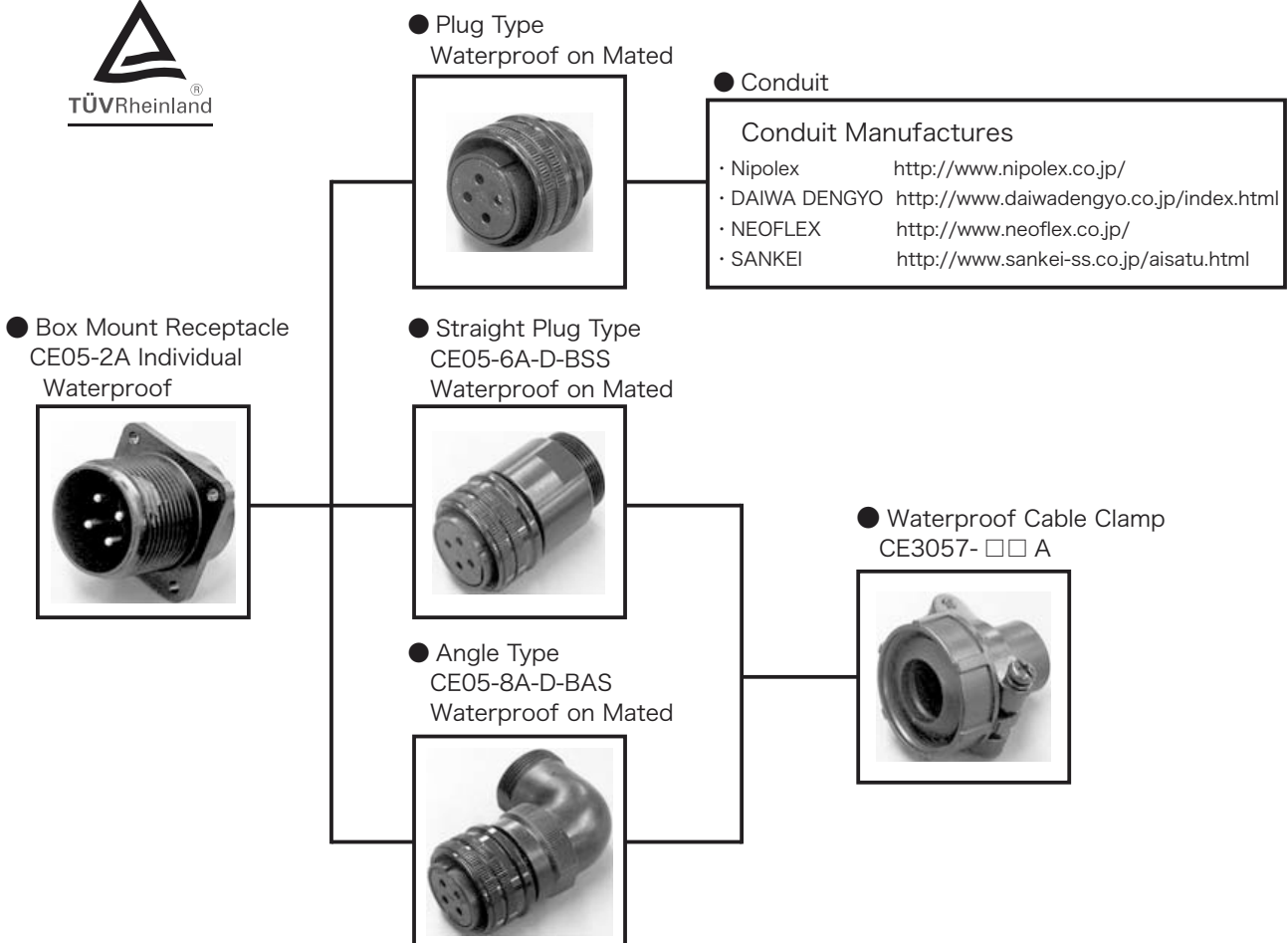

■ Intermateable with D/MS series

© Specifications and/or dimensions in this catalog are subject to change without notice.
Your checking the latest specifications with our drawings would be highly appreciated.

<http://www.ddknet.co.jp>

▶ Box Mount Receptacle Connector

P/N : CE05-2A18-10PDYS-D

①
②③
④⑤⑥⑦
⑧



① Shell Style	2A : Box Mount Receptacle
② Shell Size	10SL, 14S, 18, 20, 22, 24 and 32
③ Insert Arrangement	Refer to page 3
④ Contact Style	P : Pin Contact S : Socket Contact
⑤ Ground Contact	Refer to page 3
⑥ Alternate Insert Position	Omit : Standard W, X, Y, Z : Refer to page 4
⑦ Gasket	Omit : Without Gasket S : With Gasket
⑧ Finish	D : Black Trivalent Chromium Treatment

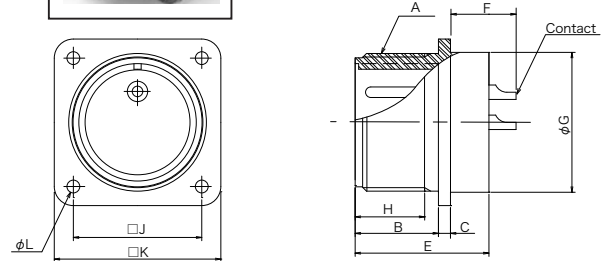

Note : Place a gasket on the rear of the flange. (Thickness: 1.6mm)

Part Number	A	$\begin{matrix} +0.97 \\ B \\ -0.50 \end{matrix}$	$C \pm 0.35$	$E \pm 0.5$	$F \pm 1$	$G \pm 0.5$	H	$J \pm 0.12$	$K \pm 0.5$	$\begin{matrix} +0.25 \\ \phi L \\ -0.12 \end{matrix}$
CE05-2A10SL-3PC-D	5/8-24UNEF-2A	14.27	2.15	23.5	12.4	16.0	9.53	18.26	25.4	3.05
CE05-2A14S-2PD-D	7/8-20UNEF-2A	14.27	2.15	23.5	12.4	20.75	9.53	23.01	30.2	3.05
CE05-2A18-10PD-D	1 1/8-18UNEF-2A	19.05	2.75	30.5	14.2	27.0	15.88	26.97	34.9	3.05
CE05-2A18-10SD-D					18.6					
CE05-2A18-12PD-D					13.3					
CE05-2A20-4PD-D	1 1/4-18UNEF-2A	19.05	2.75	30.6	14.2	32.0	15.88	29.36	38.1	3.05
CE05-2A20-4SD-D					18.6					
CE05-2A20-15PD-D					14.2					
CE05-2A20-15SD-D					18.6					
CE05-2A20-18PDE-D					14.7					
CE05-2A22-22PD-D	1 3/8-18UNEF-2A	19.05	2.75	31.5	17.2	33.0	15.88	31.75	41.3	3.05
CE05-2A22-22SD-D					22.0					
CE05-2A22-23PD-D					14.3					
CE05-2A22-23SD-D					18.6					
CE05-2A24-10PD-D	1 1/2-18UNEF-2A	20.63	2.75	33.85	15.6	36.0	15.88	34.92	44.4	3.74
CE05-2A24-10PG-D					15.6					
CE05-2A24-11PGH-D					15.6					
CE05-2A32-17PD-D	2-18UNS-2A	22.23	3.35	38.15	20.2	48.0	15.88	44.45	56.9	4.30
CE05-2A32-17SD-D					20.62					

Note : CE05-2A □□ - □□ S □ -D has reverse style of the contacts which are the socket contacts.
The mating half connectors should have the pin contacts.

Panel Mounting Dimension

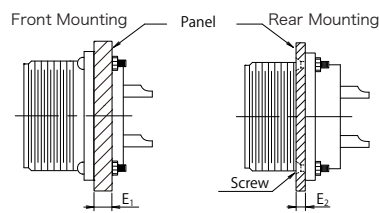
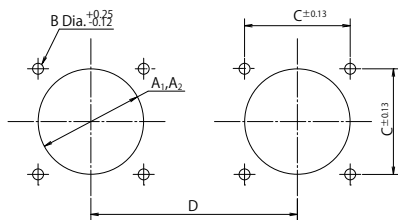

Shell Size	Front Mounting	Rear Mounting	B	C	D	E1 Max.	E2 Max.	Panel Mounting Screw(Ref)
	A1 (Min.)	A2 (Min.)						
10SL	16.8	16.6	3.05	18.26	47	10	3.0	M3
14S	20.0	23.0	3.05	23.01	53	10	3.0	M3
18	26.4	29.3	3.05	26.97	59	10	3.0	M3
20	29.5	32.5	3.05	29.36	62	10	3.0	M3
22	32.7	35.7	3.05	31.75	70	10	3.0	M3
24	35.9	38.8	3.75	34.92	73	10	3.0	M3.5
32	49.3	51.5	4.40	44.45	86	10	3.0	M4

▶ Plug Connector
P/N : CE05-6A18-10SDY-DBSS
 ① ② ③ ④ ⑤ ⑥ ⑦ ⑧

① Shell Style	6A : Straght Plug 8A : Angle Plug
② Shell Size	10SL, 14S, 18, 20, 22, 24 and 32
③ Insert Arrangement	Refer to page 3
④ Contact Style	P : Pin Contact S : Socket Contact
⑤ Ground Contact	Refer to page 3
⑥ Alternate Insert Position	Omit : Standard W. X. Y. Z : Refer to page 4
⑦ Finish	D : Black Trivalent Chromium Treatment
⑧ Backshell	Omit : Without Backshell BSS : Straight Backshell BAS : Angle Backshell

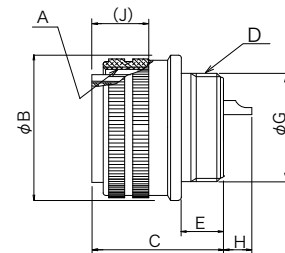
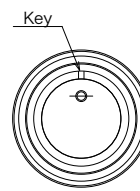

Part Number	A	$\begin{matrix} +0 \\ B-0.38 \end{matrix}$	C±1	D	E±0.5	$\begin{matrix} +0.25 \\ G-0.25 \end{matrix}$	H±0.1	(J)
CE05-6A10SL-3SC-D	5/8-24UNEF-2B	22.22	24.0	9/16-24UNEF-2A	7.50	12.5	5.6	13.2
CE05-6A14S-2SD-D	7/8-20UNEF-2B	28.57	24.0	3/4-20UNEF-2A	8.46	17.0	5.6	13.2
CE05-6A18-10SD-D	1 1/8-18UNEF-2B	34.13	33.7	1-20UNEF-2A	11.74	23.5	6.4	19.0
CE05-6A18-10PD-D							1.7	
CE05-6A18-12SD-D							5.6	
CE05-6A20-4SD-D	1 1/4-18UNEF-2B	37.28	34.1	1 1/8-18UNEF-2A	12.16	26.8	6.0	19.0
CE05-6A20-4PD-D							1.7	
CE05-6A20-15SD-D							6.0	
CE05-6A20-15PD-D							1.7	
CE05-6A20-18SDE-D							6.17	
CE05-6A22-22SD-D	1 3/8-18UNEF-2B	40.48	34.1	1 1/4-18UNEF-2A	14.65	29.9	9.3	19.0
CE05-6A22-22PD-D							4.2	
CE05-6A22-23SD-D							6.1	
CE05-6A22-23PD-D							1.3	
CE05-6A24-10SD-D	1 1/2-18UNEF-2B	43.63	36.6	1 3/8-18UNEF-2A	13.42	32.9	6.8	19.4
CE05-6A24-10SG-D							6.8	
CE05-6A24-11SGH-D							6.8	
CE05-6A32-17SD-D	2-18UNS-2B	56.33	37.0	1 7/8-16UN-2A	13.14	45.3	9.2	19.4
CE05-6A32-17PD-D							8.7	

Note 1 : CE05-6A □□ - □□ P □ -D has reverse style of the contacts which are the pin contacts.
The mating half connectors should have the socket contacts.

Note 2 : Contact conduit manufacturers when you use conduits since no conduit is available from our product line.

▶ Straight Plug

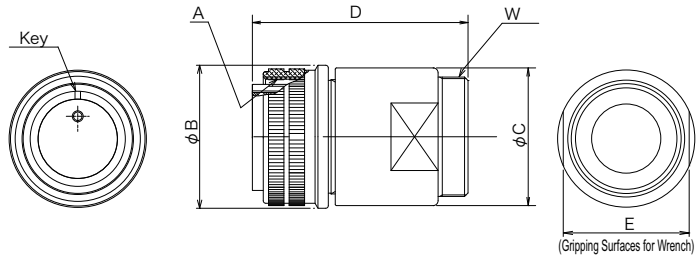

Part Number	A	$B^{+0}_{-0.38}$	$C \pm 0.8$	D Max.	E	W
CE05-6A10SL-3SC-D-BSS	5/8-24UNEF-2B	22.22	18.6	40	17.9	5/8-24UNEF-2A
CE05-6A14S-2SD-D-BSS	7/8-20UNEF-2B	22.22	25.2	45	22.0	3/4-20UNEF-2A
CE05-6A18-10SD-D-BSS	1 1/8-18UNEF-2B	34.13	32.1	57	26.7	1-20UNEF-2A
CE05-6A18-10PD-D-BSS						
CE05-6A18-12SD-D-BSS						
CE05-6A20-4SD-D-BSS	1 1/4-18UNEF-2B	37.28	35.2	61	31.6	1 3/16-18UNEF-2A
CE05-6A20-4PD-D-BSS						
CE05-6A20-15SD-D-BSS						
CE05-6A20-15PD-D-BSS						
CE05-6A20-18SDE-D-BSS	1 3/8-18UNEF-2B	40.48	38.3	61	32.4	1 3/16-18UNEF-2A
CE05-6A22-22SD-D-BSS						
CE05-6A22-22PD-D-BSS						
CE05-6A22-23SD-D-BSS	1 1/2-18UNEF-2B	43.63	42.0	68	36.6	1 7/16-18UNEF-2A
CE05-6A22-23PD-D-BSS						
CE05-6A24-10SD-D-BSS						
CE05-6A24-10SG-D-BSS	2-18UNS-2B	56.33	54.2	79	47.3	1 3/4-18UNS-2A
CE05-6A24-11SGH-D-BSS						
CE05-6A32-17SD-D-BSS						
CE05-6A32-17PD-D-BSS						

▶ Angle Plug

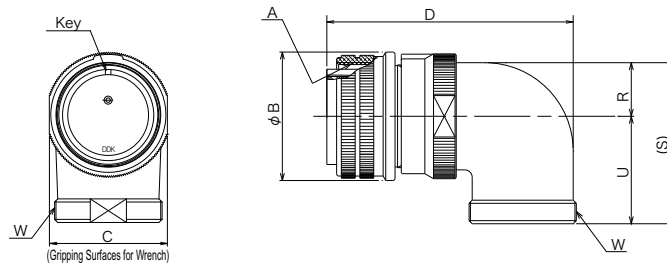

Part Number	A	$B^{+0}_{-0.38}$	D Max.	C	W	$R \pm 0.7$	$U \pm 0.7$	$(S) \pm 1$
CE05-8A10SL-3SC-D-BAS	5/8-24UNEF-2B	22.22	47.8	20.3	5/8-24UNEF-2A	7.9	21.0	28.9
CE05-8A18-10SD-D-BAS	1 1/8-18UNEF-2B	34.13	69.5	30.0	1-20UNEF-2A	13.2	30.2	43.4
CE05-8A18-10PD-D-BAS								
CE05-8A18-12SD-D-BAS								
CE05-8A20-4SD-D-BAS	1 1/4-18UNEF-2B	37.28	75.5	33.6	1 3/16-18UNEF-2A	15.0	33.3	48.3
CE05-8A20-4PD-D-BAS								
CE05-8A20-15SD-D-BAS								
CE05-8A20-15PD-D-BAS								
CE05-8A20-18SDE-D-BAS	1 3/8-18UNEF-2B	40.48	75.5	36.2	1 3/16-18UNEF-2A	16.3	33.3	49.6
CE05-8A22-22SD-D-BAS								
CE05-8A22-22PD-D-BAS								
CE05-8A22-23SD-D-BAS	1 1/2-18UNEF-2B	43.63	86.3	40.0	1 7/16-18UNEF-2A	18.2	36.5	54.7
CE05-8A22-23PD-D-BAS								
CE05-8A24-10SD-D-BAS								
CE05-8A24-10SG-D-BAS	2-18UNS-2B	56.33	93.5	52.8	1 3/4-18UNS-2A	24.6	44.5	69.1
CE05-8A24-11SGH-D-BAS								
CE05-8A32-17SD-D-BAS								
CE05-8A32-17PD-D-BAS								

© Specifications and/or dimensions in this catalog are subject to change without notice.
 Your checking the latest specifications with our drawings would be highly appreciated.

<http://www.ddknet.co.jp>

Waterproof Straight Backshell

P/N : CE05-18BS-S-D

① ② ③ ④ ⑤



① Shell Size	10SL, 14S, 18, 20, 22, 24 and 32
② Model	B : Backshell
③ Style	S : Straight
④ Waterproof	S : Waterproof
⑤ Finish	D : Black Trivalent Chromium Treatment

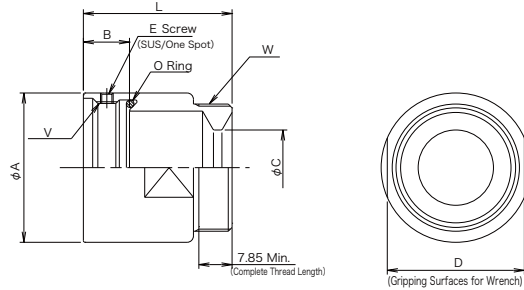

MATERIAL/FINISH

Aluminum Alloy / Black Trivalent Chromium Treatment

Shell Size	Part Number	L	A	B	C	D	E	V	W
10SL	CE05-10SLBS-S-D	20.0	18.6	6.5	6.6	17.9	M2	9/16-24UNEF-2B	5/8-24UNEF-2A
14S	CE05-14SBS-S-D	24.4	25.2	7.3	10.0	22.0	M2	3/4-20UNEF-2B	3/4-20UNEF-2A
18	CE05-18BS-S-D	31.0	32.1	10.5	16.3	26.7	M3	1-20UNEF-2B	1-20UNEF-2A
20	CE05-20BS-S-D	35.0	35.2	10.9	17.8	31.6	M3	1 1/8-18UNEF-2B	1 3/16-18UNEF-2A
22	CE05-22BS-S-D	35.0	38.2	10.9	17.8	32.4	M3	1 1/4-18UNEF-2B	1 3/16-18UNEF-2A
24	CE05-24BS-S-D	40.5	42.0	12.2	21.0	36.6	M4	1 3/8-18UNEF-2B	1 7/16-18UNEF-2A
32	CE05-32BS-S-D	46.0	54.2	11.7	25.8	47.3	M4	1 7/8-16UN-2B	1 3/4-18UN-2A

Waterproof Angle Backshell

P/N : CE-18BA-S-D

① ② ③ ④ ⑤



① Shell Size	10SL, 18, 20, 22, 24 and 32
② Model	B : Backshell
③ Style	A : Angle
④ Waterproof	S : Waterproof
⑤ Finish	D : Black Trivalent Chromium Treatment

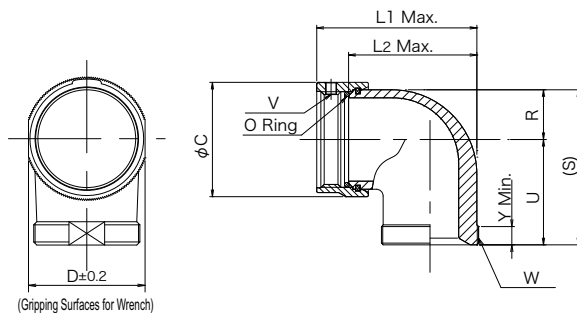

MATERIAL/FINISH

Aluminum Alloy / Black Trivalent Chromium Treatment

Shell Size	Part Number	L1	L2	C	D	R	U	(S)	V	W	Y
10SL	CE-10SLBA-S-D	30.6	22.5	21.7	20.3	7.9	21.0	(28.9)	9/16-24UNEF-2B	5/8-24UNEF-2A	7.5
18	CE-18BA-S-D	44.6	34.0	32.4	30.0	13.2	30.2	(43.4)	1-20UNEF-2B	1-20UNEF-2A	7.5
20	CE-20BA-S-D	50.5	39.6	36.0	33.6	15.0	33.3	(48.3)	1 1/8-18UNEF-2B	1 3/16-18UNEF-2A	7.5
22	CE-22BA-S-D	50.5	39.6	38.6	36.2	16.3	33.3	(49.6)	1 1/4-18UNEF-2B	1 3/16-18UNEF-2A	7.5
24	CE-24BA-S-D	60.1	47.9	42.4	40.0	18.2	36.5	(54.7)	1 3/8-18UNEF-2B	1 7/16-18UNEF-2A	7.5
28	CE-28BA-S-D	60.9	47.9	49.5	46.4	21.3	36.5	(57.8)	1 5/8-18UNEF-2B	1 7/16-18UNEF-2A	7.5
32	CE-32BA-S-D	69.1	55.1	55.3	52.8	24.6	44.5	(69.1)	1 7/8-16UN-2B	1 3/4-18UNEF-2A	8.5

Waterproof Cable Clamp

P/N : CE3057-10A-1-D

① ② ③



① Clamp Size	4A, 10A, 12A, 16A and 20A
② Bushing Size	Rubber Bushing (Refer to the applicable cable size)
③ Finish	D : Black Trivalent Chromium Treatment

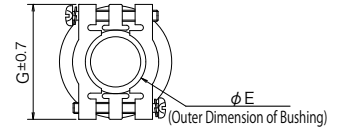
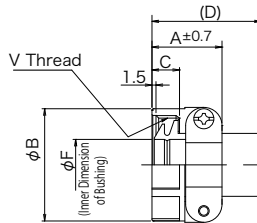

MATERIAL/FINISH

MATERIAL	Material	Finish
Cable Clamp Body and Metal Fastener	Aluminum Alloy	Black Trivalent Chromium Treatment
Bushing	Synthetic Rubber	Black

CE3057-□□A-□-D is a waterproof cable clamp for use with a plug. The cable clamp has a waterproof rubber bushing. So make sure to use a cable meeting one of the applicable cable size ranges as shown below. The cable clamp should be used together with a waterproof backshell.

Part Number	Applicable Shell Size	A	B	C	(D)	E	F	G	V	Bushing P/N	Applicable Cable Size
CE3057-4A-1-D	10SL, 12S	20.62	20.6	10.31	(41.3)	8.0	5.6	22.2	5/8-24UNEF-2B	CE3420-4-1	φ 3.6 ~ φ 5.6
CE3057-6A-1-D	14S	22.20	24.6	10.31	(41.3)	10.8	9.0	27.0	3/4-20UNEF-2B	CE3420-6-1	φ 7.0 ~ φ 9.0
CE3057-10A-1-D	18	23.83	30.1	10.31	(41.3)	15.8	14.1	31.7	1-20UNEF-2B	CE3420-10-1	φ 10.5 ~ φ 14.1
11							CE3420-10-2			φ 8.5 ~ φ 11.0	
8.7							CE3420-10-3			φ 6.5 ~ φ 8.7	
CE3057-12A-1-D	20 22	23.83	35	10.31	(41.3)	19.0	16	37.3	1 3/16-18UNEF2B	CE3420-12-1	φ 12.5 ~ φ 16.0
13							CE3420-12-2			φ 9.5 ~ φ 13.0	
10							CE3420-12-3			φ 6.8 ~ φ 10.0	
17							CE3420-12-7			φ 14.5 ~ φ 17.0	
19.1							CE3420-16-1			φ 15.0 ~ φ 19.1	
CE3057-16A-1-D	24 28	26.19	42.1	10.31	(41.3)	23.8	15.5	42.9	1 7/16-18UNEF-2B	CE3420-16-2	φ 13.0 ~ φ 15.5
21.5							CZY005-GB-3			φ 19.1 ~ φ 21.5	
20							CE3420-16-6			φ 18.5 ~ φ 20.0	
13.5							CE3420-16-7			φ 11.5 ~ φ 13.5	
12.5							CZY005-GB-5			φ 10.5 ~ φ 12.5	
23.8							CE3420-20-1			φ 22.0 ~ φ 23.8	
CE3057-20A-1-D	32	27.79	51.6	11.91	(43.0)	32.0	26.6	51.6	1 3/4-18UNS-2B	CE3420-20-2	φ 24.0 ~ φ 26.6
22.5							CE3420-20-3			φ 22.0 ~ φ 22.5	
22.5							CE3420-20-3			φ 22.0 ~ φ 22.5	

▶ Waterproof Rubber Bushing

CE3420-10-1

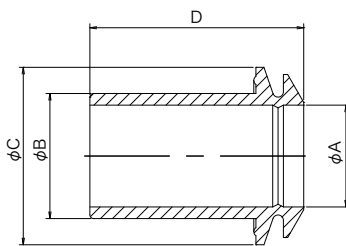

① Cable Clamp Size	4, 6, 10, 12, 16 and 20
② Bushing Size	Refer to table 1.

MATERIAL

Synthetic Rubber(Black)

CE3420-□□A-□ is a rubber bushing which combines with a cable clamp(CE3057-□□A-□) to hold the cable for waterproof.

Table 1

Part Number	φ A	φ B	φ C	D	Friction Washer
CE3420-4-1	5.6	7.5	12.9	38.3	MS3057-4W
CE3420-6-1	9.0	10.9	15.7	36.4	MS3057-6W
CE3420-10-1	14.1	15.5	22.2	38.5	MS3057-10W
CE3420-10-2	11.0				
CE3420-10-3	8.7				
CE3420-12-1	16.0	18.6	26.9	39.3	MS3057-12W
CE3420-12-2	13.0				
CE3420-12-3	10.0				
CE3420-12-7	17.0				
CE3420-16-1	19.1	23.4	33.2	40.0	MS3057-16W
CE3420-16-2	15.5				
CE3420-16-6	20.0				
CE3420-16-7	13.5				
CE3420-20-1	23.8	31.4	40.5	41.0	MS3057-20W
CE3420-20-2	26.6			40.2	