

# SEFRAM 9822-9822B

## Data Logger Hygro-thermometer



## Instruction Manual

32, rue Edouard Martel

BP55

F42009 – Saint Étienne Cedex 2

E-mail: [sales@sefram.fr](mailto:sales@sefram.fr)

Tel : 04 77 59 01 01

Fax : 04 77 57 23 23

Web : [www.sefram.fr](http://www.sefram.fr)

# CONTENTS

TITLE	PAGE
<b>1. General Description</b> .....	1
<b>2. Safety Information</b> .....	1
<b>3. Features</b> .....	1
<b>4. Specifications</b> .....	2
<b>5. Symbol Definition &amp; Button Location</b> .....	3
<b>6. Button Instructions</b> .....	5
6.1 Power ON/OFF Button.....	5
6.2 Backlight Button.....	5
6.3 Data-Hold Button.....	5
6.4 REC Button.....	5
6.5 MEM Button.....	5
6.6 RECALL Saved Reading Button.....	5
6.7 MAX/MIN/AVG Button.....	6
6.8 Selecting DP/WB Temperature.....	6
6.9 SETUP Button.....	6
<b>7. Operating Instructions</b> .....	6
7.1 Setup Options.....	6
7.2 Menu Item.....	6
7.3 Menu Description.....	8
7.3.1 Set Bluetooth ON/OFF.....	8
7.3.2 Select Thermocouple Type.....	9
7.3.3 Set Unit.....	9
7.3.4 Setting Interval Time For Data Storing.....	9
7.3.5 Set Offset To Compensate For Probe Errors.....	9
7.3.6 Set Alarm Point.....	9
7.3.7 Set Auto Power Off Time.....	10
7.3.8 Set System Clock.....	10
7.4 Clearing Data Logger Records.....	11
7.5 Clearing Instant Read-out Memory.....	11
7.6 Connecting To a Computer.....	11
<b>8. Power &amp; Bluetooth Adapter Preparation</b> .....	11
8.1 Battery Replacement.....	11
8.2 Bluetooth Adapter Installation.....	12
<b>9. Maintenance</b> .....	12
<b>10. Connection Between Probe &amp; Main Unit</b> .....	12
<b>11. Testlink SE-522 Software</b> .....	13

## 1. GENERAL DESCRIPTION

Thank you for choosing our Data Logger Hygro Thermometer. To ensure the safety and the best performance of this instrument, we recommend you to read and follow the manual carefully before operation.

Data can be stored in the meter or directly saved on a computer through PC interface. Recorded data can be further processed on a computer.

## 2. SAFETY INFORMATION

Read the following safety information carefully before attempting to operate or service the meter. Use the meter only as specified in this manual; otherwise, the protection provided by the meter may be impaired.

### ENVIRONMENT CONDITIONS

- Altitude up to 2000 meters
- Relative humidity: 90% max
- Operation ambient temperature: 0°C to 50°C

### MAINTENANCE & CLEARING

- Repairs or servicing not covered in this manual should only be performed by qualified personnel.
- Periodically wipe the case with a dry cloth. Do not use abrasives or solvents on this instrument.

### SAFETY SYMBOLS

 Comply with EMC

When servicing, use only specified replacement parts.

## 3. FEATURES

- Interchangeable digital probes
- Dew point and Wet bulb measurement
- Support K, J, E, T, N, R, S type thermocouple
- Temperature and humidity alarm function
- Fast response and sampling rate
- 32000 data logger records each channel
- Instant recall function
- Wirelessly connect to PC or mobile device via Bluetooth Adapter
- iOS and Android APP available to download from APP store
- USB PC interface with Windows software included
- Adjustable auto power off timer

## 4. SPECIFICATIONS

### 4-1 Probe: RP-33

**Sensor type:** Semi-Conductor humidity and temperature sensor

**Relative humidity range:** 0 to 100%RH

**Temperature range:** -20°C to 60°C (-4°F to 140°F) (253K to 333K)

**Dew point temperature range:** -50°C to 60°C (-58°F to 140°F) (223K to 333K)

**Wet bulb temperature range:** -20°C to 60°C (-4°F to 140°F) (253K to 333K)

**Resolution:** 0.1%RH, 0.1°C, 0.1°F, 0.1K

**Accuracy:** [at 23°C(73.4°F)]

10%RH to 90%RH	±2.5%RH
<10%RH,>90%RH	±5.0%RH
-20 to 60°C (-4 to 140°F)	±0.8°C (±1.5°F)

**Response time:** Humidity: 60 sec. In slowly moving air

(@t90) Temperature: 20 sec. in slowly moving air (T1)

**Sensor hysteresis:** < 1.5%RH with excursion of 90 % to 10 % to 90%

**Temperature coefficient:** 0.1 x (specified accuracy) per 1°C [ < 23°C(73.4°F) or > 23°C(73.4°F)]

### 4-2 Thermocouple

**Measurement range:** K: -200°C ~1372°C (-328°F ~ 2501°F) (73K ~ 1645K)  
 J: -200°C~1000°C (-328°F ~ 1832°F) (73K ~ 1273K)  
 E: -200°C~750°C (-328°F ~ 1382°F) (73K ~ 1023K)  
 T: -200°C~400°C (-328 °F ~ 752°F) (73K ~ 673K)  
 N: -200°C ~1300°C(-328°F ~ 2372°F) (73K ~ 1573K)  
 R, S: 0°C ~1767°C(32°F ~ 3212°F) (273K ~ 2004K)

**Resolution:** K-,J-,E-,T-,N-,R-,S-type  
 0.1°C < 600°C / 0.1°F < 1000°F / 0.1K < 873K,  
 1°C ≥ 600°C / 1°F ≥ 1000°F / 1K ≥ 873K

**Accuracy:** K-,J-,E-,T-,N-type: ±(0.1% of reading+0.7°C)  
 [at 25°C(77°F)±5°C] ±(0.1% of reading+1.3°F)  
 below -100°C ( -148°F )  
 ±(0.5% of reading +0.7°C)  
 ±(0.5% of reading +1.3°F)

R- and S-type: ±(0.2% of reading+1.4°C)

±(0.2% of reading+2.5°F)

**Temperature coefficient:** 0.01% of reading + 0.05°C(0.0028°F) per °C [<18°C(64°F) or >28°C(82°F)]

**Sample rate:** 2 time per second

**Battery type:** UM-4 or AAA 1.5V battery x 4

**Battery lifetime:** Bluetooth OFF: Approx. 100 hours (alkaline battery)  
 Bluetooth ON: Approx. 30 hours (alkaline battery)

**Operation temperature:** 0°C to 50°C (32°F to 122°F)

**Operation humidity:** 10 to 90%RH (no condensing)

<b>Storage temperature:</b>	-20°C to 60°C (-4°F to 140°F)
<b>Storage humidity:</b>	10 to 75%RH
<b>Dimensions/ Weight:</b>	Meter: 187mm(L) × 75mm(W) × 29mm(H) / Approx. 330g Probe(RP-33): 16mm Diameter x 98mm(L)
<b>Standard Accessories:</b>	Instruction manual, battery 1.5V AAA x 4 pcs, Windows software, micro USB cable, K type bead probe, carrying case.

## 5. SYMBOL DEFINITION & BUTTON LOCATION

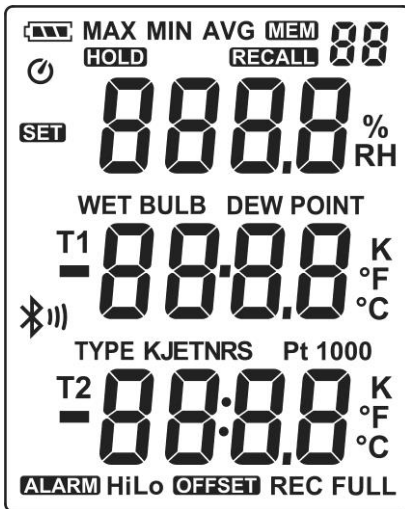

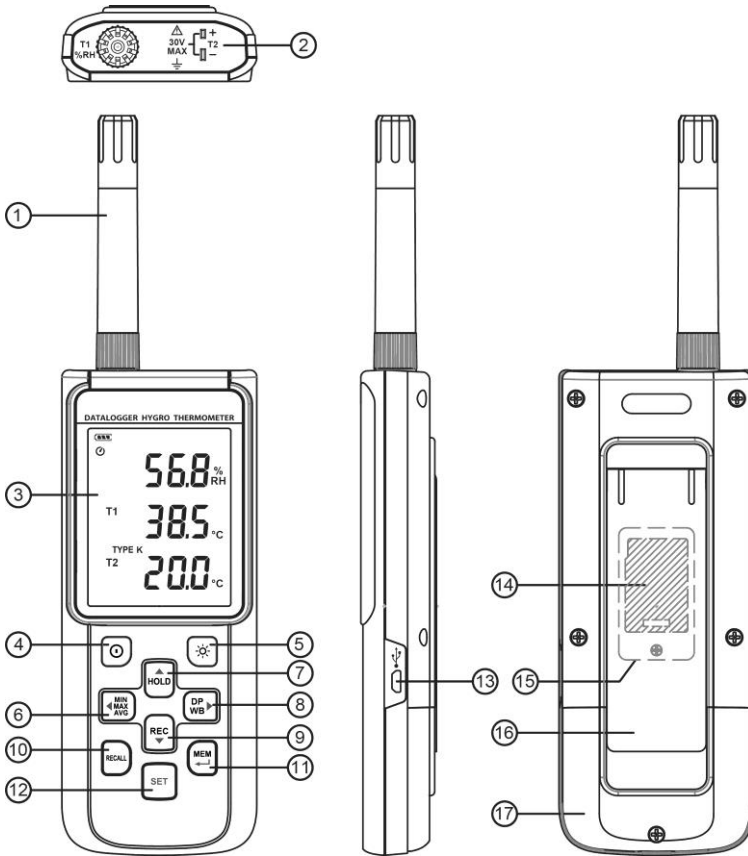

	: Battery condition indicator
<b>MIN</b>	: Minimum indicator
<b>MAX</b>	: Maximum indicator
<b>AVG</b>	: Average indicator
<b>SET</b>	: Setup option indicator
	: Auto Power Off enabled indicator
<b>REC</b>	: Recording data logger indicator
<b>FULL</b>	: Memory full indicator
<b>MEM</b> 88	: Memory group indicator
<b>RECALL</b> 88	: Recall Memory group reading indicator
TYPE KJETNRS	: Thermocouple type
8888	: Relative Humidity reading
-8888	: Temperature reading
<b>T1 T2</b>	: Temperature channel
<b>ALARM</b>	: Temperature/Humidity alarm indicator
<b>Hi</b>	: Hi Temperature alarm indicator
<b>Lo</b>	: Lo Temperature alarm indicator
<b>OFFSET</b>	: Compensate for probe errors
°C °F K	: Temperature measurement units
<b>HOLD</b>	: Data hold indication
	: Bluetooth indicator (Connecting mode)
	: Bluetooth indicator (Standby/Pairing mode)





- ,1 Sensor Probe
- ,2 Thermocouple Input
- ,3 Display Screen
- ,4 Power ON/OFF Button
- ,5 Back Light Button
- ,6 MAX MIN AVG Button
- ,7 DATA HOLD Button
- ,8 DP/WB Button
- ,9 REC Button
- ,10 RECALL Saved Reading Button
- ,11 MEM Button (Set 100 Memory)
- ,12 SETUP Button
- ,13 USB Interface
- ,14 Bluetooth Adapter
- ,15 Bluetooth Compartment
- ,16 Tilt Stand
- ,17 Battery Compartment

## 6. BUTTON INSTRUCTIONS

### 6.1 Power ON/OFF Button:

Press the  button to turn on the meter. Press and hold  button for 3 seconds to turn off.

### 6.2 Backlight Button:



Press  to turn on the LCD backlight. This makes it easier to read in dark environment. Press  again to turn off backlight. The backlight will be automatically turned off after 30 seconds to save battery power.



### 6.3 Data-Hold Button :

Press  button to freeze the data shown on the LCD screen. Press it again to exit Data-Hold mode.

**Note:** When the unit is in the Data-Hold mode, , , , and  buttons are disabled.

### 6.4 REC Button:



Press  button to start recording data. The “**REC**” symbol will display on the screen. To stop recording, press  button again.

**Note:** During recording period, most of the buttons are disabled, such as the , . All settings must be made before starting the data logger function.

**Note:** When the memory is full (32,000 recorders), “**FULL**” symbol will blink on the LCD screen. The data logger stops.

**Note:** When battery power is low (“” symbol lights up on the screen), data logger cannot be started. If the battery is running low during data logging, it will stop recording automatically.





### 6.5 MEM Button:

Press  button to save readings on the LCD screen. The “**MEM 88**” symbol lights up on the screen for 2 seconds. Press the  button again to store next group readings. The store readings on the LCD screen for 00~99 group.

### 6.6 RECALL Saved Reading Button:

Press the  button to recall saved readings. The “**RECALL 88**” symbol lights up on the screen.

**Note:** When the meter is during connection section, this function is disabled.





Press the , , , or  button to select MEM group. The LCD shows “**hour:minute:second**” on the screen for 2 seconds, and then shows the readings.

Press  or  button to exit RECALL mode.

## 6.7 MAX/MIN/AVG Button:

Under this mode, the unit simultaneously monitors and stores the maximum, minimum and average value in the memory. The unit will keep updating/refreshing the data.



### To start:

- (1) Press  button. “ **MAX** ” symbol lights up on LCD, the reading shows the maximum data.
- (2) Press  button again to show minimum data; the “ **MIN** ” symbol lights up on LCD.
- (3) Press  button again to show average data; the “ **AVG** ” symbol lights up on LCD.
- (4) Press  button again, the “ **MAX, MIN and AVG** ” symbol blinks together, the readings shows real time data.



### To exit MAX/MIN/AVG mode:

Press and hold  button for 2 seconds to exit MAX/MIN/AVG mode.

## 6.8 Selecting DP/WB Temperature :

The Meter displays ambient temperature when first turned on. To display wet bulb (WB) temperature, press  once. Press  again to switch to dew point (DP) temperature. Pressing  third time returns the Meter to ambient temperature. The display indicates when dew point and wet bulb temperatures are selected.

## 6.9 SETUP Button:







Press the  button to enter setup options. Press  again to exit setup mode anytime.

**Note:** When the meter is during connection section, setup options cannot be entered.

# 7. OPERATING INSTRUCTIONS

**⚠ When moving thermometer from one extreme temperature/humidity environment to another, allow time for the Meter to stabilize.**

## 7.1 Setup Options:

- (1) Press the  button to enter setup options. Press it again to exit anytime.
- (2) Using the , , ,  button to adjust parameters or move setting items.
- (3) Press the  button to save changes and move to next setting option.



## 7.2 Menu Item:



(1) Fig.1 Set Bluetooth ON/OFF.

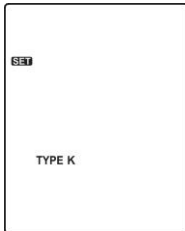

(2) Fig.2 Set thermocouple type.



(3) Fig.3 Set Unit.



(4) Fig.4 Set interval time for data logging.

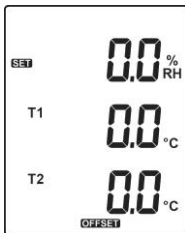

(5) Fig.5 Set offset to compensate for probe errors.

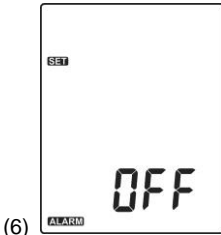

(6) Fig.6 Set alarm point.

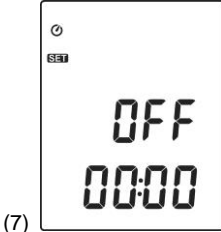

(7) Fig.7 Set auto power off time.



(8) Fig.8 Set system clock.

### 7.3 Menu Description:

#### 7.3.1 Set Bluetooth ON/OFF



Press the  or  button to turn on or off. (see Fig.9 or Fig.10)



Fig.9





Fig.10

**Note:**

When Bluetooth function is turned ON, it is entering standby/pairing mode, the blue LED built in  flashes once every 3 seconds. When successfully connected, the blue LED quickly flashes thrice every 3 seconds.

### 7.3.2 Select Thermocouple Type: K, J, E, T, N, R or S

Press the  or  button to select thermocouple type. (see Fig.11)

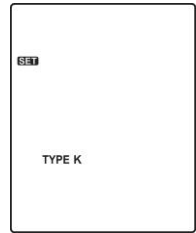

Fig.11

### 7.3.3 Set Unit:

(1) Press the  or  button to select °C, °F, K.

### 7.3.4 Setting Interval Time For Data Storing:





- (1) Press the  or  button to set minute or second. (see Fig.12)
- (2) Press the  /  button to increase / decrease value.



Fig.12



#### **Note:**

Set interval time range:

1 Second (00:01) to 60 minutes 59 seconds (60:59)

### 7.3.5 Set Offset To Compensate For Probe Errors:

The user can adjust the readings of thermometer to compensate for the errors against a specific thermocouple.

(1) Press the  or  button to select channel. (see Fig.13)

Setting channel blinks on the LCD screen.

(2) Press the  /  button to increase / decrease value.

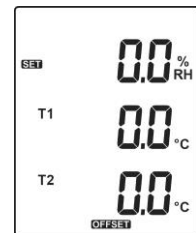

Fig.13

#### **Note:**

The offset to compensate for probe errors range:  $\pm 5\%$  RH,  $\pm 5^{\circ}\text{C}$  or  $\pm 9^{\circ}\text{F}$ .

### 7.3.6 Set Alarm Point:



(1) Press the  or  button to turn ON or OFF. (see Fig.14 or Fig.15)



Fig.14



Fig.15

- (2) When setting on mode, press the  button to set Hi and Lo limit.  
 ( RH alarm setting see Fig.16 and Fig.17 )  
 ( T1 alarm setting see Fig.18 and Fig.19 )  
 ( T2 alarm setting see Fig.20 and Fig.21 )

**Note:**

When measuring value over alarm point, the symbol will blink " **ALARM Hi** " or " **ALARM Lo** " on the LCD.

The beeper will make " beep-beep-beep " sound.

The Lo alarm set cannot be greater than Hi alarm set.



Fig.16

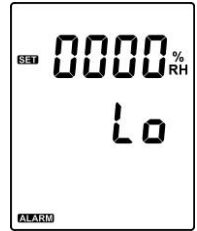

Fig.17



Fig.18



Fig.19

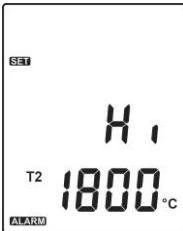

Fig.20

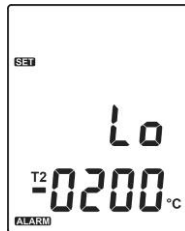

Fig.21

**7.3.7 Set Auto Power Off Time:**



- Press the  or  button to select auto power off option 10, 30 minutes, 1, 2, 4, 8 hours, or off.  
 (see Fig.22 or Fig.23)



Fig.22





Fig.23

**7.3.8 Set System Clock:**

The unit is built-in a clock so that the data logger function can also record the data and time along with the measurement value.

- (1) Press the  or  button to select year, date, or time.  
 (see Fig.24)

- (2) Press the  /  button to increase/ decrease value.





**Note:**

Check the clock setting after replacing batteries. If necessary, reset system clock.







Fig.24

### 7.4 Clearing Data Logger Records:

- (1) Turn off the unit.
- (2) Press and hold  button and then press  power button to turn on the unit.
- (3) Keep holding  and  button, then LCD will show "REC", "CLr" and "SURE 5, 4...1, 0" until clean the memory. (To abort, release all buttons in process)

### 7.5 Clearing Instant Read-out Memory:

- (1) Turn off the unit.
- (2) Press and hold  button and then press  power button to turn on the unit.
- (3) Keep holding  button, then LCD will show "MEM", "CLr" and "SURE 5, 4...1, 0" until clean the memory. (To abort, release  button before "SURE 0".)  
The LCD will show "CLr", "0" and start erasing group 00 to 99 records.

### 7.6 Connecting To a Computer:

The meter can be connected to PC through a micro USB cable or Bluetooth adapter to download recorded data or perform real time monitoring or datalogging in the software interface.

## 8. POWER & BULETOOTH ADAPTER PREPARATION

### 8.1 Battery Replacement:

- (1) When the battery voltage drops below proper operation range, the  symbol will blink on the LCD display and the battery needs to be replaced.
- (2) Before replacing the battery, power off the meter, and disconnect all temperature probes.  
Open the cover of the battery cabinet by a screwdriver. Replace the old batteries with four new UM-4 or AAA size batteries.
- (3) Close the battery cabinet cover and fasten the screw.

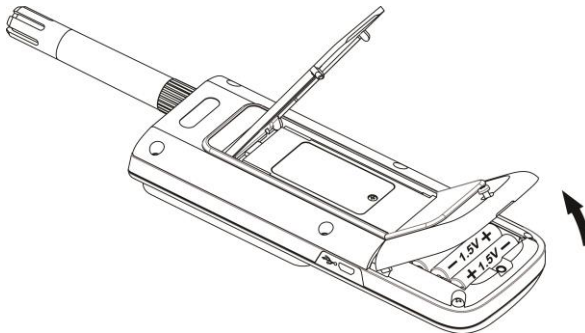

## 8.2 Bluetooth Adapter Installation:

- (1) Power off
- (2) Open the cover of the Bluetooth cabinet by a screwdriver.
- (3) Install the Bluetooth adapter into its compartment, push up the adapter to the connector.

Close the Bluetooth cabinet cover and fasten the screw.

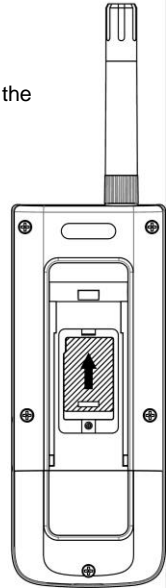
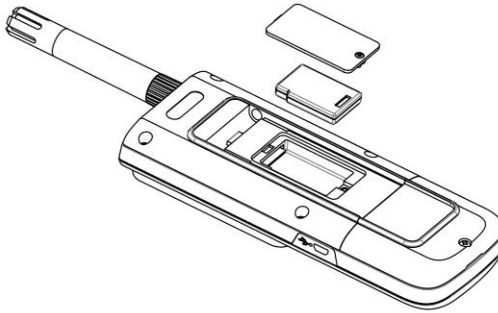

## 9. Maintenance

In order to ensure the accuracy of the thermometer for a longer period of time you should calibrate it once a year.

Clean the device and the window of the display with a clean, lint-free, antistatic and dry cleaning cloth.

**⚠ Do not use cleaning agents that contain carbon or benzenes, alcohol or anything similar to clean the product since these substances damage the surface of the measuring instrument. Moreover, these fumes are hazardous to health and explosive. Do not use tools with sharp edges, screwdrivers, metal brushes or anything similar to clean the device.**

## 10. CONNECTION BETWEEN PROBE & MAIN UNIT

The probe can be connected or disconnected from the main unit by fastening screw as shown in the graph. Rotate only the fastening screw rather than the probe body to prevent from damaging the probe.

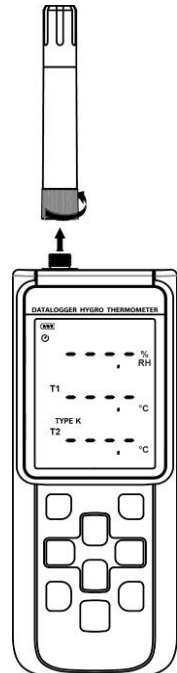

## 11. Testlink SE-522 SOFTWARE

### 11.1 The SE-522 package contains:

- Software CD disk
- Micro USB cable

### 11.2 System Required:

Windows XP/ VISTA/ Windows 7/ Windows 8/ Windows 10

### 11.3 Minimum Hardware Required:

- PC or laptop with CD-ROM drive.
- At least 50 MB hard disk space available to install SE522
- Recommended screen resolution 1024X768 or above.

### 11.4 Tutorial - Quick Start to Use SE522:

#### Recording real time data in waveform:

(1) Power on the meter first and connect it to a PC USB port with the cable.(or set the Bluetooth ON)

(2) Start SE522 program, or ( Click "search Bluetooth device" or  to establish connection.)

**Note:** Before clicking "search Bluetooth device" or , make sure Bluetooth pairing have finished.

(3) If the connection is successful the panel will display the same value (or Bluetooth symbol ) as the Hygro Thermometer. If fail to connect the meter with PC, it will display " **No Connection** " on the panel window in SE522.

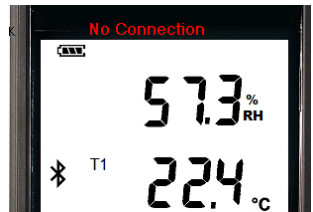

(4) Select sampling rate from Real-Time Graph window.

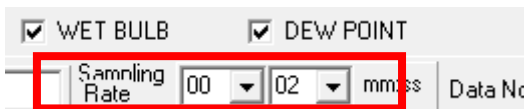

(5) When the connection is successful, click " **Real Time | run** " or  from main menu to start recording real time data and there will be a waveform on the Real Time Graph Window.

(6) Click " **Real Time | Stop** " or  to stop recording.

## 11.5 How to save the recorded real time data to a file?

- (1) Click the graph window you want to save and the graph window will become active, then choose File | Save from main menu or click from the tool bar .

an active window



not active window



- (2) There will be a save dialog window for you to choose the file name and file type to save. There are three types of file format you can choose, binary file(\*.ghf), text file(\*.txt) and EXCEL format file(\*.csv). The \*.ghf file use much fewer disk space to save the data than the other two file formats, but it can only be used in SE522. Text file can be opened by SE522 and any other word processor program like word, notepad etc. EXCEL format file can be opened by SE522 and Microsoft EXCEL.

**Note:** If decimal separator is comma in your country, this file format will be disabled, because .CSV file also use comma to be data separator. For example 78,6 will become 78 and 6 in EXCEL )

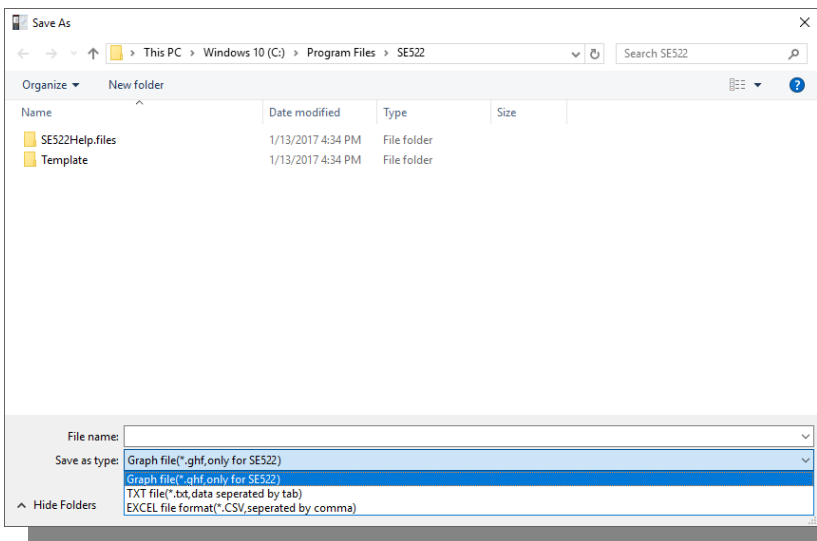



## 11.6 How to load the recorded data from the memory of Hygro Thermometer and save it to a file?



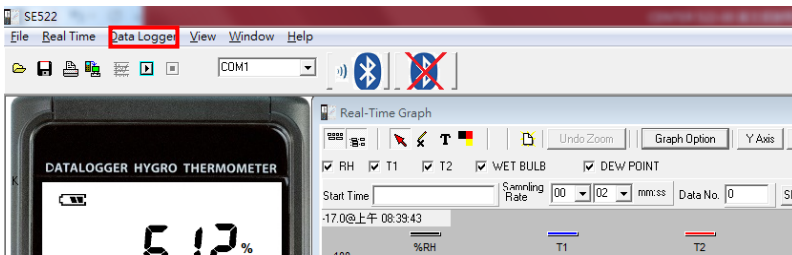

- (1) Power on the Hygro Thermometer.
- (2) Press the “ **REC** ” button of the meter to start recording data.
- (3) After a while, press “ **REC** ” button again to stop recording data.
- (4) Connect the Meter to PC
- (5) Start SE522 program.
- (6) Choose Data Logger from main menu or click  from tool bar.

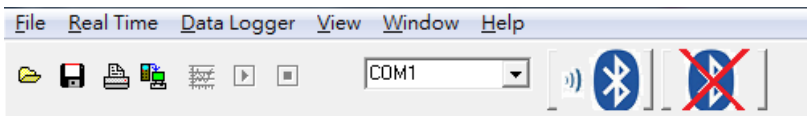

- (7) In reference to Data Logger , see DataLogger

## 11.7 Main Menu:



-  **File | Open**- Retrieve files from the disk.
-  **Save** - Save the active window (when the caption bar is highlighted) data to the disk.
-  **Print** - Print the data of the active window (graph or list).
- Printer Setup** - Select printer.
- File | Exit**: Terminates program.
- View | Control Panel:**  
By opening the Panel Window, the user can control meter via the button in this window.
- View | Real-Time Graph:**  
Open Real-Time Graph display to graph the present data.
-  **Real Time Data | Run** - Start collecting real time data.
-  **Stop** - Stop collecting real time data.



### DataLogger:

By opening the DataLogger Window, the user can load recorded data of meter to PC in this window.



### Output To Graph - Graphing tabular data.



### Com port of Bluetooth device –

Choose com port to connect to Bluetooth device.



### Search Bluetooth Device -

Automatically searching and connecting to Bluetooth device.



### Disconnect Bluetooth Device – Disconnecting from Bluetooth device.

## 11.8 DataLogger:

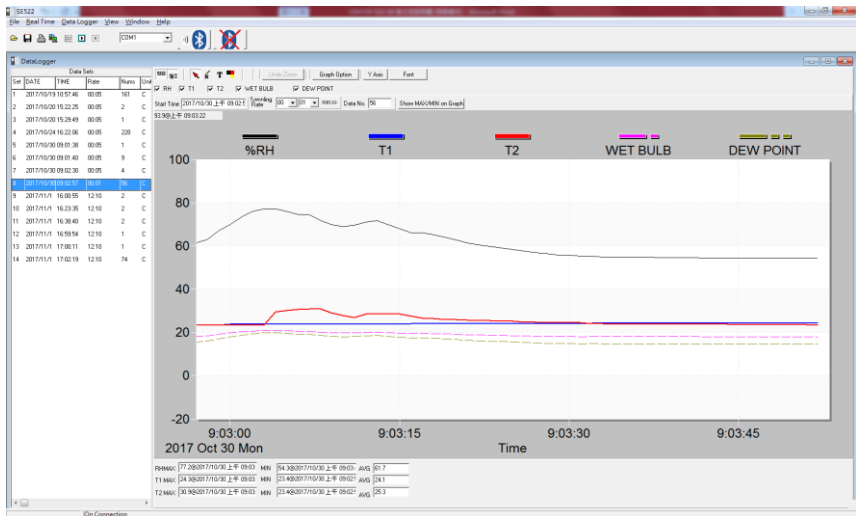

When you have the **Hygro** thermometer connected to PC, select " **DataLogger** " from main menu or click Datalogger icon from tool bar to load recorded data from the meter and there will be a progress indicator to show the loading status. If error occurs, just click " **DataLogger icon** " again.

After the data was downloaded, the left hand side will show how many data sets were loaded and detail information for each data set (start data, start time, recording rate and record numbers).

for examples:



Data Sets										
Set	DATE	TIME	Rate	Nums	Unit	Couple	RH Offset	T1 Offset	T2 Offset	
1	2017/10/23	13:13:47	00:02	234	C	K	0.0	0.0	0.0	
2	2017/11/1	11:18:37	00:01	591	C	K	0.0	0.0	0.1	
3	2017/11/1	11:38:34	00:01	60	C	K	0.0	0.0	0.1	
4	2017/11/1	11:39:45	00:01	59	C	K	0.0	0.0	0.1	

It will transfer first data set to graph on the right hand side. The user can also click at any other data set to choose that set for graph.

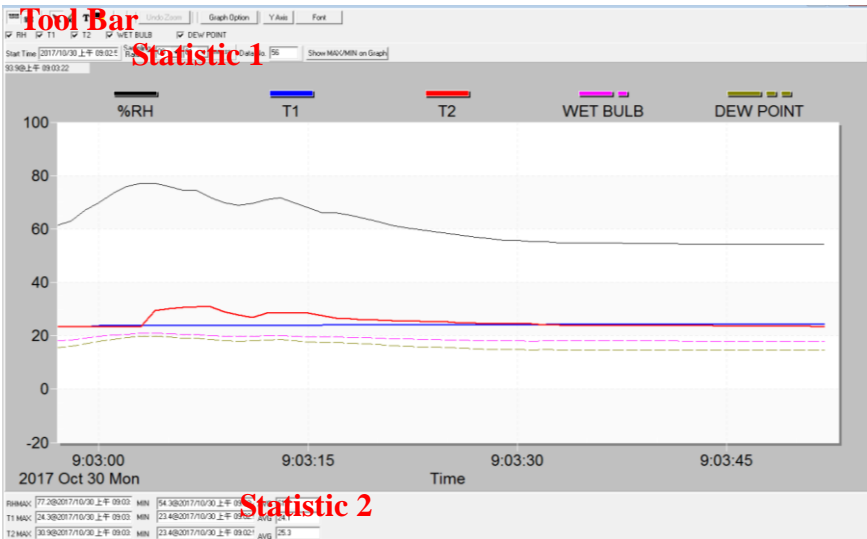
**Graph:**



**Tool Bar:**

-  - Display or hide Statistic1.
-  - Display or hide Statistic2.



- Normal cursor.



- When selected, the mouse cursor will become a cross sign when moving to the graph, click on the graph to mark a cross sign on the graph. And all the mark you make will exist with T1.



- When selected, the mouse cursor will become a "I" sign when moving to the graph, click on the graph to annotate. And all the text you make will exist with T1.

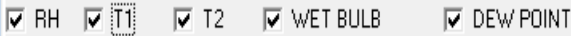

- Select the channel.

**Graph Option** - Graph Customization

**Y Axis** - Change the Y axis extension

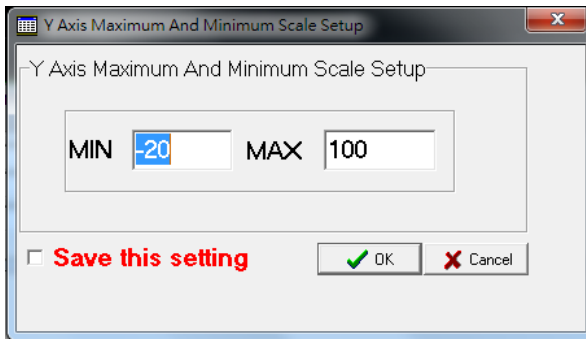

**Undo Zoom** - To Undo the Zoom

You can Zoom this graph by using mouse:

To Zoom:

- (1) Press the left mouse button and drag the cursor to select the new extents.
- (2) Release the mouse button.

You can choose channel number showing in the graph.

- (a) Click " **Graph Option** " to call Customization dialog.
- (b) Select Subsets tab.
- (c) Select a single channel or multiselect (hold Ctrl key, use mouse to choose) channels.

## 11.9 Frequently Asked Question:

### (1) How to uninstall SE522 ?

**Answer:** Uninstall SE522 by launching the Add/Remove Programs applet out of the Control Panel, highlighting the SE522, and clicking on the Add/Remove... push button, then it will remove the SE522 folder and files from your computer.

### (2) How to zoom the graph?

**Answer:** Press the left mouse button and drag the cursor to select the new extents, then release the mouse button.

### (3) When I setup the real time sampling with a fast rate(eg. 1 sec), Some of the sampling data might be lost.

**Answer:** This might be caused by slow response time of the PC interface. For better result, the user may close the panel window.

### (4) How to continue to use the meter when the battery has run down ?

**Answer:** With USB interface powered directly, you can continue to use the meter.

## 11.10 Bluetooth Pairing:

### 11.10.1 Via ACTION CENTER (Windows 10)

- (1) Open [ ACTION CENTER ];
- (2) Click [ All Settings ];
- (3) Click [ Devices ];
- (4) Select [ Bluetooth ];
- (5) Turn On;
- (6) Select [ BT-xxxxxx ](serial number);
- (7) Click [ Pair ];
- (8) After installing, the device will appear as paired.

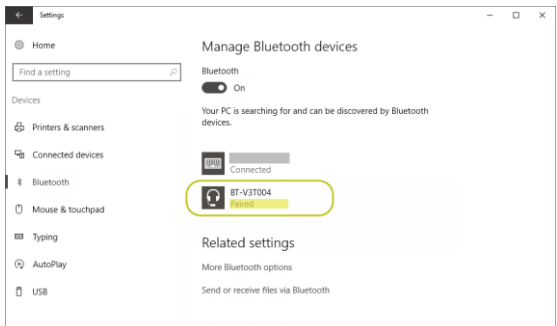
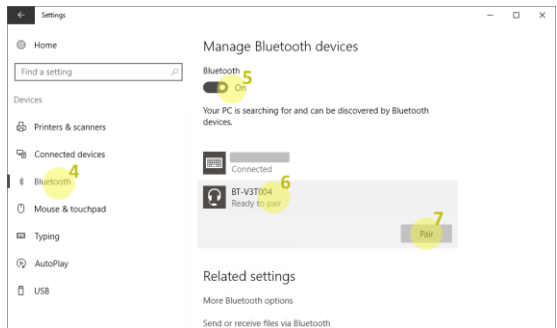
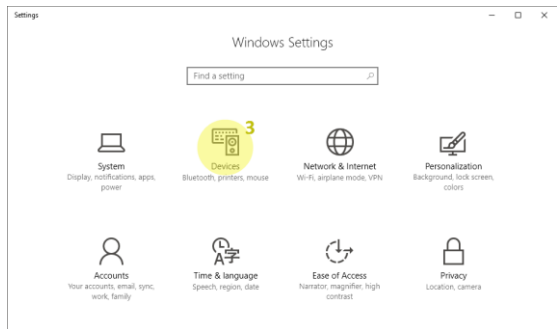
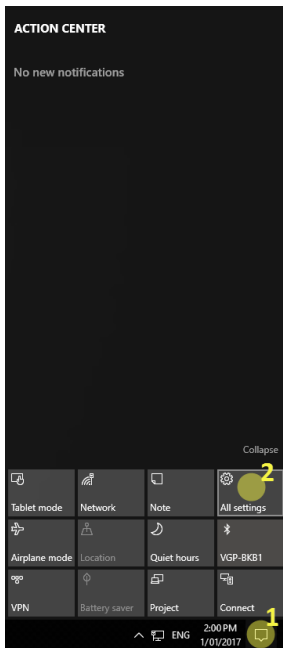

### 11.10.2 Via Contro Panel

(1) Click [ START ] and then click [ Devices and Printers ];

(2) Click [ Add a device ];

(3) Choose  BT-XXXXX Bluetooth Adapter , then click [ Next ].

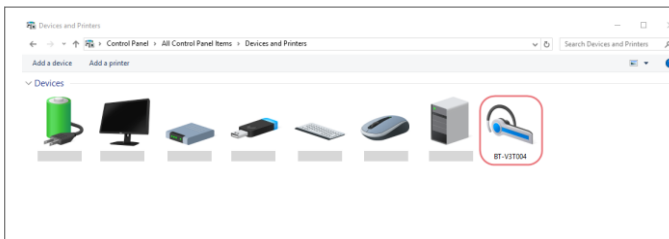
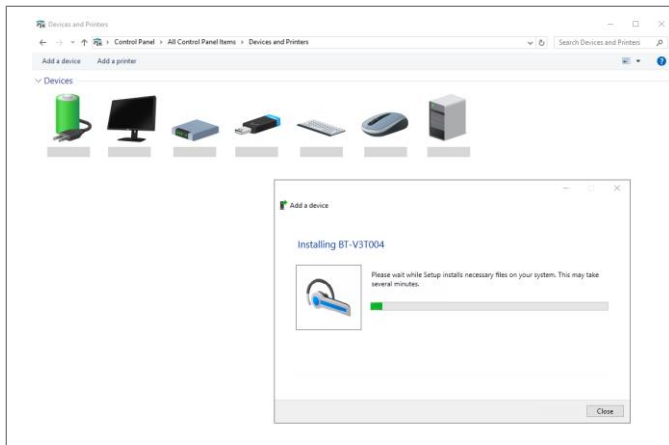
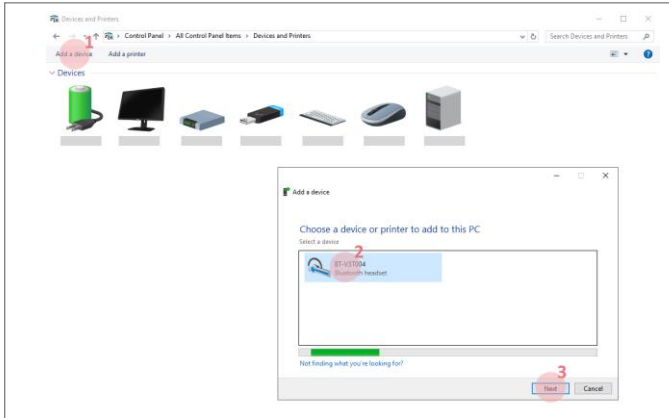

- (4) To find out which COM port has been allocated to the meter, click on the Windows Start button and search for “Bluetooth” and choose “Change Bluetooth settings”

#### Control Panel (4)

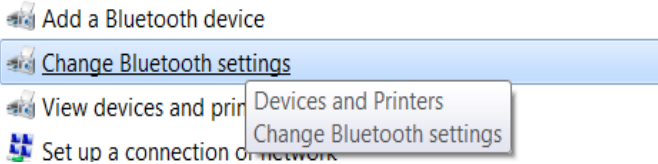

- (5) Click on the “COM Ports” tab to see which port has been allocated to the meter.

