

# SEFRAM 9835

## Digital Sound Level Meter



### Instruction manual

SEFRAM  
32, rue Edouard Martel  
BP55  
F42009 – Saint Étienne Cedex 2  
E-mail: sales@sefram.fr

Tel : 04 77 59 01 01  
Fax : 04 77 57 23 23  
Site Internet : [www.sefram.fr](http://www.sefram.fr)  
E-mail: sales@sefram.fr

# SOUND LEVEL METER SEFRAM 9835

## Instruction manual

---

### Safety Information

Read the following safety information carefully before attempting to operate or service the meter.

Use the meter only as specified in this manual; otherwise, the protection provided by the meter may be impaired.

#### Environment Conditions:

- Altitude up to 2000 meters
- Relatively humidity 90% max.
- Operation Ambient 0 ~ 40°C

#### Explanation of Symbols:



Attention! Refer to operation instructions.



Comply with EMC.

When servicing, use only specified replacement parts.

### Introduction

This Sound Level Meter has been designed to meet the measurement requirements of safety Engineers, Health, Industrial safety offices and sound quality control in various environments.

Both AC and DC signal outputs are available from standard 3.5mm coaxial socket, suitable for a frequency analyzer, level recorder, FFT analyzer, graphic recorder, etc.

### Specifications

Standard Applied: IEC61672-1 Class2

Frequency Range: 20Hz ~ 8KHz

Measuring level Range: 32 ~ 130dB

Frequency Weighting: A / C

Microphone: 1/2 inch electret condenser microphone

Digital Display:

4 digits

Resolution: 0.1dB

Display update: 0.5 sec.

Analog display:

30 segment bar graphs

Resolution: 2dB

Display update: 100 mS

Time weighting: FAST, SLOW

Level ranges:

Lo: 30 - 90 dB

Med: 50 - 110 dB

Hi: 70 - 130 dB

Accuracy:

±1.4dB (under reference conditions)

Dynamic Range: 60 dB

Alarm Function:

“ **OVER** ” is show when input is more than upper limit of range.

“ **OVER** ” is show when input is Less than lower limit of range.

AC Output:

1 Vrms at FS (full scale)

FS: means the upper limit of each level Range.

DC Output: 10mV / Db

Power Supply: One 9V battery, 006P or IEC 6F22 or NEDA 1604

Power Life: Approx. 60hrs (alkaline Battery)

Operation Temperature: 0 to 40°C (32 to 104°F)

Operation Humidity: 10 to 90%RH

Storage Temperature: -10 to 60°C (14 to 140°F)

Storage Humidity: 10 to 75%RH

Dimension / Weight: 258×55×25mm (10.2”×2.2”×1.0”) / Approx. 185g

Accessories: battery, Instruction manual, Windscreen, Tool box.

## Measurement Preparation

### 1. Battery capacity indicator:

When operating the unit on battery, periodically check this indicator to determine the remaining battery capacity.

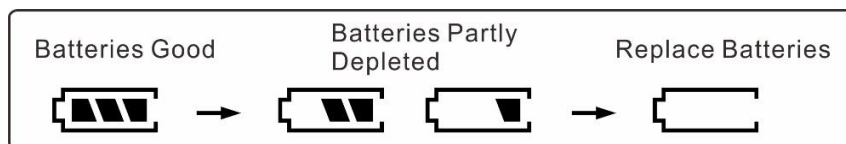

### 2. Battery Loading:

Remove the battery cover on the back and insert a 9V Battery.

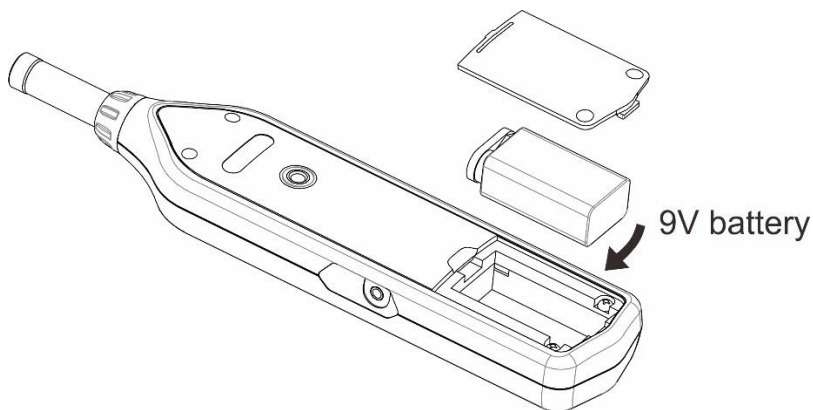

## Calibration Procedures

(1) Press and hold “**MIN MAX**” button and then power on the meter, LCD display “**CAL 94dB**” symbol.

(2) Insert the microphone housing carefully into the insertion hole of the calibrator.

(3) Press (>) or (?) button to increase or decrease number.

(4) Press “**MIN MAX**” button to finish. To abort during a setup process, press power button to cancel.

**Note:** Our products are all well calibrated before shipment.

*Using a standard Acoustic Calibrator  
(94dB, 1KHz Sine wave )*

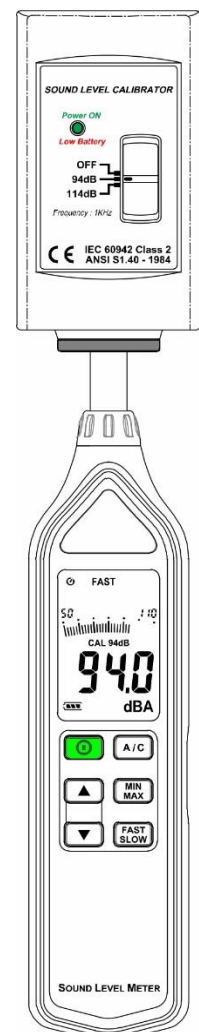

Recommended recalibration cycle: 1 year.

## Maintenance

### Attention!

Repairs or servicing not covered in this manual should only be performed by qualified personnel.

### Cleaning

Periodically wipe the case with a dry cloth. Do not use abrasives or solvents on this instrument.

## Symbol Definition & Button Location

### 1. Name of Parts & Position:

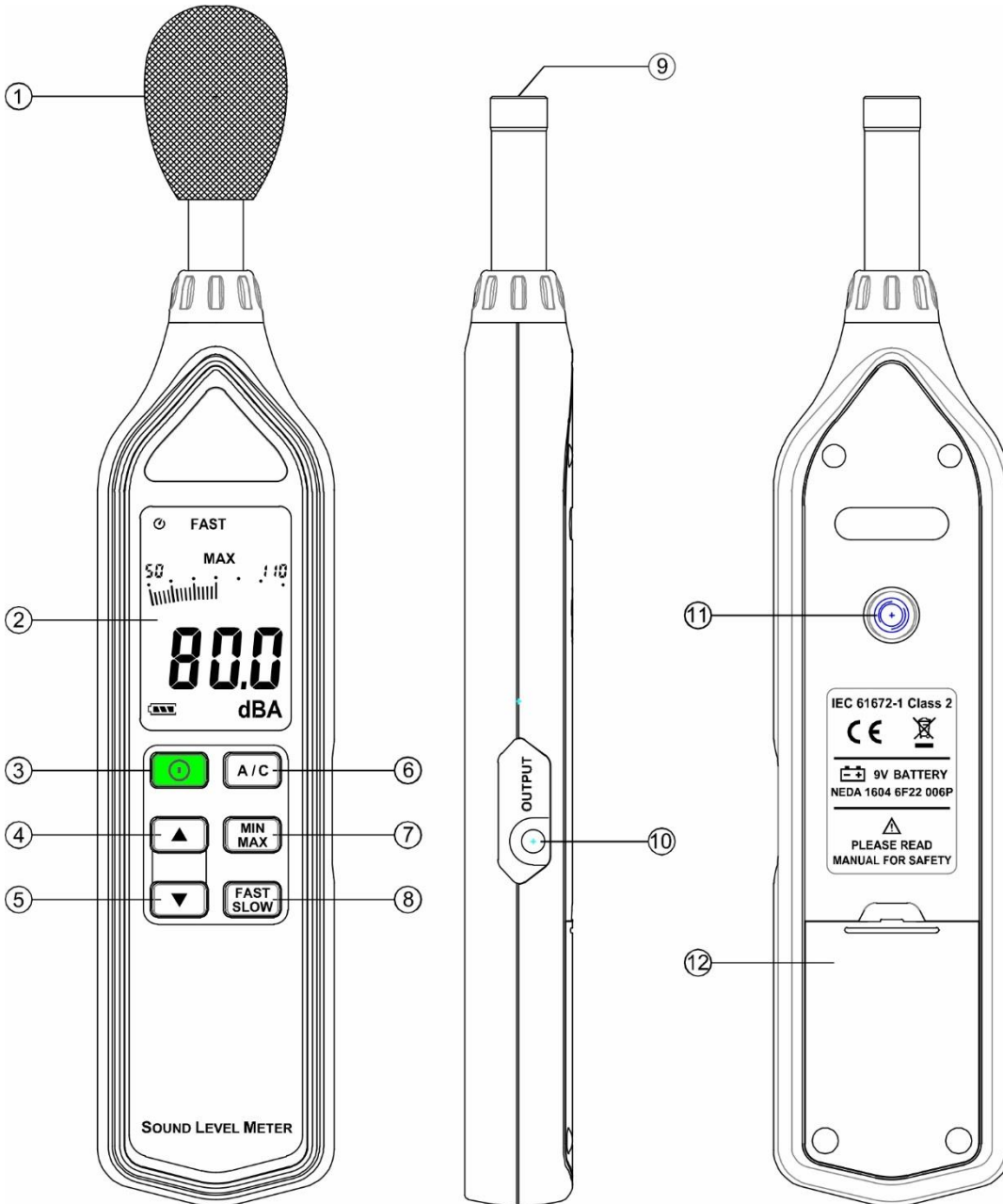

(1) Windscreen.

(2) Display: 4 digits LCD display

(3) Power Switch:

The  key turns the sound level meter ON.

Press and hold this button for 2 seconds to turn OFF the power.

#### Auto Power Off:

By default, when the meter is powered on, it is under auto power off mode. The meter will power itself off after 30 minutes if no key operation.

One may press and hold “ **FAST SLOW** ” button and then power on the meter and the  will not show up to indicate that auto power off is disabled.

#### (4) Level range control button:

Each time the () button is pressed. The level range increments from “ **Lo** ” Level to “ **Hi** ” Level range.

#### (5) Level range control button:

Each time the () button is pressed. The range decreases from “ **Hi** ” Level to “ **Lo** ” Level range.

#### (6) Frequency Weighting select switch:

A: A - Weighting. for general sound level measurements.

C: C - Weighting. for checking the low-frequency content of noise.

(If the C-Weighted level is much higher than the A-weighted level, then there is a large amount of low-frequency noise.)

#### (7) MAX / MIN hold switch:

Press “**MIN MAX**” button to enter the maximum and minimum recording mode. Select the proper Level range before using MAX/MIN to ensure that reading value will not exceed the measurement range. Press once to select MAX value. Press again to select MIN value, and press again to select current value with “ **MAX MIN** ” annunciator blinking.

Press and hold down “**MIN MAX**” button for 2 seconds to exit the MAX.MIN mode.

**Note: If change sound level range or change A-C weight, the MAX.MIN mode will be cleared.**

#### (8) Time weighting select Switch:

FAST: for normal measurements

SLOW: for checking average level of fluctuating noise.

#### (9) Microphone:

1/2 inch Electret Condenser microphone.

#### (10) AC / DC output terminal:

AC Output: 1 Vrms corresponding to each range step.

DC Output: 10mV/dB.

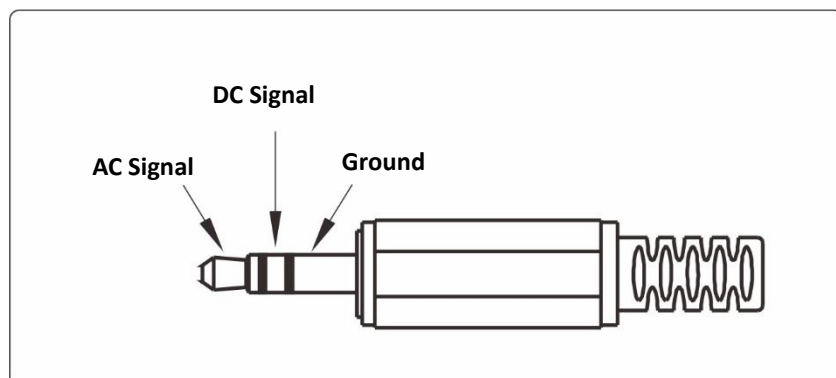

#### (11) Tripod mounting screw

#### (12) Battery Cover

## 2. LCD Display:

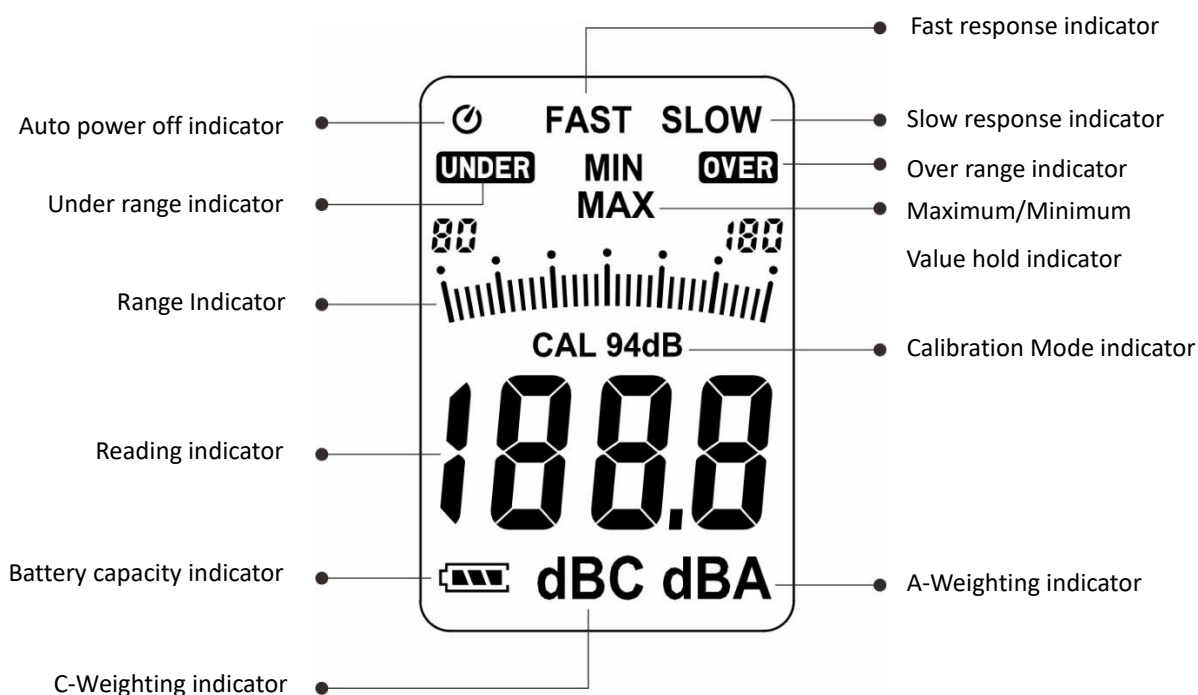

### Operating Precautions

- (1) Wind blowing across the microphone would bring additional extraneous noise. Once using the instrument in the presence of wind, it is a must to mount the windscreen to avoid picking up undesirable signals.
- (2) Calibrate the instrument before operation if the instrument was not in use for a long time or operated at bad environment.
- (3) Do not store or operate the instrument at high temperature and high humidity environment.
- (4) Keep microphone dry and avoid severe vibration.
- (5) Please take out the battery and keep the instrument in low humidity environment when not in use.

### Measurement

- (1) Turn on and select the desired response time and weighting. If the sound source consists of short bursts, set response to **FAST**. To measure average sound level, use the **SLOW** setting. Select A weighting for general noise sound level and C weighting for measuring sound level of acoustic material.
- (2) Select desired Level.
- (3) Hold the instrument comfortably in hand or fix on tripod and point the microphone at the suspected noise source, the sound pressure level will be displayed.
- (4) When MAX MIN (maximum, minimum hold) mode is chosen. The instrument captures and holds the maximum and minimum noise level for a long period using any of the time weightings and ranges. Press the "**MIN MAX**" button 2 seconds to clear the MAX/MIN reading. "**MIN/MAX**" symbol disappears.
- (5) Turn OFF the instrument.