



---

MANUAL MOTOR STARTER GUIDE

# Manual motor starter

## MS116, MS132 and MS165



# Foreword

**ABB is a pioneering technology leader in electrification products, robotics and motion, and industrial automation, serving customers in utilities, industry and transport and infrastructure globally. Continuing a history of innovation spanning more than 130 years, ABB today is writing the future of industrial digitalization with two clear value propositions: bringing electricity from any power plant to any plug and automating industries from natural resources to finished products.**

ABB offers a wide range of manual motor starters (MMS), also known as motor protective circuit-breakers. We realize that with all the standards, rules, listings and codes, the what, when, where, why and how of manual motor starters can appear complex.

The following information is provided to aid in the proper use of ABB manual motor starters and all their capabilities.

This handbook is written with the aim of being a general guide for people working with manual motor starter applications, but also for those who are simply interested in learning more about the products, standards and applications. All these are relevant for European applications (based on IEC) and North American applications (UL / CSA).

The handbook is neither a complete technical guide nor a manual for all types of ABB's motor starting solutions. It is a complement to the catalog, data sheets and brochures available for our products and will provide a general overview of what to consider when working with manual motor starters.

More information on manual motor starters as well as other ABB products is available at:

<https://new.abb.com/low-voltage/products/motor-protection>.

All the information provided in this handbook is only general and each individual application must be handled as a specific case. Be sure to always follow all national and local installation regulations/codes for your specific application.

## Table of Contents

Foreword .....	2
<b>1. Standards and approvals for manual motor starters .....</b>	<b>8</b>
1.1 European directives applicable for manual motor starters .....	8
1.2 CE Marking .....	8
1.3 Standards for North America .....	8
1.4 CCC (China Compulsory Certification) .....	9
1.5 Other local approvals based on IEC-standard .....	9
1.6 Marine approvals .....	9
1.7 Potentially explosive atmospheres (ATEX) .....	9
1.8 Applied standards .....	12
<b>2. General product overview .....</b>	<b>13</b>
2.1 Basic function .....	13
2.1.1 Release (tripping element) .....	14
2.1.2 Time-current characteristics (tripping characteristics) .....	14
2.1.3 Overload protection .....	15
2.1.4 Overload trip classes .....	15
2.1.5 Short-circuit protection .....	15
2.1.6 Phase loss sensitivity .....	16
2.1.7 Single-phase and direct current (DC) loads .....	16
2.2 Terms and ratings .....	17
2.2.1 Rated operational voltage ( $U_e$ ) .....	17
2.2.2 Rated short-circuit making capacity ( $I_{cm}$ ) .....	17
2.2.3 Rated short-circuit breaking capacity .....	17
2.2.4 Rated short-time withstand current ( $I_{cw}$ ) .....	17
2.2.5 Selectivity categories .....	18
2.2.6 Ambient air temperature compensation .....	18
2.2.7 Temperature rise of the manual motor starter .....	19
2.2.8 Trip-free mechanism .....	20
2.2.9 Phase loss sensitivity .....	20
2.2.10 Mechanical and electrical durability .....	20
2.3 Switch and breaker types .....	21
2.3.1 Motor protection circuit-breaker .....	21
2.3.2 Circuit-breaker .....	21
2.3.3 Load switch .....	21
2.3.4 Disconnect switch .....	21
2.4 Product offering .....	22
2.4.1 MS116 .....	23
2.4.2 MS132 .....	23
2.4.2.1 MS132-K .....	23
2.4.3 MS165 .....	23
2.4.4 MS132-T and MS132-KT .....	23
2.4.5 MO132 and MO165 .....	23
2.4.6 Accessories and enclosures .....	24
<b>3. Load types .....</b>	<b>29</b>
3.1 General use and heaters .....	29
3.2 Motors .....	30
3.2.1 About motors .....	31
3.2.2 Squirrel cage motors .....	31
3.2.3 International motor efficiency standards and regulations .....	32
3.2.4 Rating plate of a motor .....	37
3.2.5 Voltage .....	38
3.2.6 Current .....	38
3.2.7 Power factor .....	39

3.2.8 Torque .....	39
3.3 Hermetic refrigerant compressor motors .....	40
3.4 Lamps and lighting loads .....	41
3.5 Transformers .....	41
3.5.1 Primary-side protection of transformers.....	41
3.5.2 Secondary-side protection of transformers. ....	41
3.6 Capacitors .....	42
<b>4. Environmental and application-specific factors .....</b>	<b>43</b>
4.1 Ambient air temperature compensation and derating.....	43
4.2 Duty cycles and restarting .....	44
4.3 Frequencies and direct current (DC).....	45
<b>5. Selection criteria .....</b>	<b>46</b>
5.1 Sizing manual motor starters for motor applications .....	46
5.2 Selected Optimized Coordination (SOC) .....	46
<b>6. Installation and commissioning.....</b>	<b>48</b>
6.1 Mounting .....	48
6.1.1 Mounting position and minimum distances.....	48
6.2 Connection.....	49
6.2.1 Connection Types .....	49
6.2.2 Connection cross sections .....	49
6.3 Motor current setting procedure.....	51
6.4 Overload trip test.....	51
6.5 Restart after tripping .....	51
6.6 How to lock a manual starter by disconnecting .....	52
6.7 Installation instructions .....	52
6.8 2D drawings and 3D models .....	52
<b>7. Requirements for North America .....</b>	<b>53</b>
7.1 General certification in North America .....	53
7.1.1 Product certification marks .....	53
7.1.2 Joint U.S.-Canadian approvals.....	54
7.1.3 Relevant North American standards.....	54
7.1.4 Global harmonization efforts .....	55
7.1.5 Categorizing manual motor starters.....	55
7.1.6 Selecting the right Short Circuit Current Ratings (SCCR) level for your UL application.....	57
7.2 North American voltage supply networks and load types .....	58
7.2.1 North American voltages.....	58
7.2.2 Three-phase network configurations.....	58
7.2.3 Straight vs. slash voltage ratings .....	59
7.2.4 Short-circuit current ratings .....	59
7.2.5 Components requiring short-circuit current ratings.....	59
7.2.6 Standard (low) fault ratings - Mandatory .....	60
7.2.7 High fault ratings - Optional.....	60
7.2.8 Defined acceptance criteria .....	61
7.2.9 Calculating the available fault current for a facility .....	61
7.2.10 Additional current limiting devices.....	62
7.3 Defining branch circuits .....	62
7.4 Functional requirements for all motor branch circuits .....	63
7.4.1 Disconnect means for the motor and branch circuit.....	64
7.4.2 Short-circuit and ground-fault protection for the motor and branch circuit.....	64
7.4.3 Motor control means .....	64
7.4.4 Overload protection for the motor and branch circuit.....	64
7.4.3 Local motor disconnect .....	64
7.5 Product offering for north American applications .....	65
7.6 Suitable applications for manual motor starters for North America .....	66

7.6.1 Defining Manual Motor Controllers (NLRV).....	66
7.6.2 Defining Combination Motor Controllers (NKJH) .....	72
<b>8. Glossary.....</b>	<b>76</b>
<b>9. Appendix .....</b>	<b>78</b>

---

## Introduction

**The world industry and commerce are facing an energy challenge. Global demand for energy is rising steadily. At the same time, pressures to reduce energy consumption, to lower carbon dioxide (CO<sub>2</sub>) emissions and provide secure power supplies are becoming ever stronger.**

It has been estimated that around 300 million electric motors are installed today (with an annual growth rate of more than 5 percent). Furthermore, it has been estimated that electric motors account for about 65 percent of the electricity consumed in industrial applications.

ABB is not only a long-standing advocate of the need for high efficiency in motors and its policy is to offer high-efficiency motors as standard, but also making sure that motors and users are properly protected.

**The greatest risk for applications such as motors is overheating. Abnormal temperature rises can be caused by overloads, electrical faults, cooling problems or improper operating parameters or operation conditions. This differentiates motors and pumps from other applications, such as heating resistors or lamps.**

**Examples of such overloads include:**

Overloads caused by over current

- locked rotors
- long starting or braking times
- changes of the friction ratio of the operated engine
- non-permissible intermittent operations
- long-term overloads in continuous operation
- undervoltage

Supply problems, which could cause unsymmetrical over-currents

- earth faults
- phase loss
- phase unbalance on the supply side
- interwinding or interturn fault within the motor

Cooling problems

- reduced convection currents due to dust or dirt
- mounting position of the motor: good circulation of air prevents heat build-up
- low air density due to incorrect installation and altitude environmental parameters

# 1. Standards and approvals for manual motor starters

All ABB low voltage devices are developed and manufactured according to the rules set out in the IEC (International Electrotechnical Commission). The IEC issues publications that act as a basis for the world market. The applicable standard is the IEC 60947 series for Europe and UL 60947 for North America. All devices are built according to this standard and in most countries, they are not subject to any other tests besides the manufacturer responsibility. In some countries, the law requires additional certification.

## 1.1 European directives applicable for manual motor starters

There are essential European directives:

- **Low Voltage Directive 2014/35/EU**  
*Concerns electrical equipment from 50 to 1000 V AC and from 75 to 1500 V DC.*
- **RoHS Directive 2011/65/EU**  
*Restriction of the use of Certain Hazardous Substances in Electronic and Electrical Equipment*
- **ATEX Directive 2014/34/EU**  
*The European Parliament and of the Council on the harmonization of the laws of the Member States relating to equipment and protective systems intended for use in potentially explosive atmospheres*
- **WEEE Directive 2012/19/EU**  
*Directive of the European Parliament and of the Council of 4 July 2012 on waste electrical and electronic equipment (Waste Electrical and Electronic Equipment Directive)*

## 1.2 CE Marking

When a product is verified according to its applicable EN standard, the product is presumed to fulfil all applicable directives, e.g., the “Low Voltage Directive 2014/35/EU”, and it is allowed to apply the CE marking on the product. EN 60947-4-1 is the harmonized standard for manual motor starters and it is identical to IEC 60947-4-1. The same applies to the EN 60947-2, EN 60947-1 for the accessories the EN60947-5-1

In this case, the CE marking does not cover the “Machinery Directive, Directive 2006/42/EC” which requires a special verification of the installation of the machine. The manual motor starter is an electrical device, with mainly electrical risks. It is instead covered by the low voltage directive.

The CE marking is not a quality label, it is proof of conformity to the European Directives concerning the product.

## 1.3 Standards for North America

Specifications for the north America and Canadian markets are quite similar but differ a lot from IEC standards and European specifications. In Chapter 7. Requirements for North America, this topic will be described in more detail.

**USA** - UL Underwriters Laboratories Inc.

**Canada** - CSA Canadian Standards Association

There are different types of UL certification, including UL listed and UL component recognition. UL listing means that UL has tested representative samples of the product and determined that it meets UL’s requirements. UL’s component recognition service, however, only covers the evaluation of components or materials intended for use in a complete product or system. All ABB manual motor starters that have UL certification, are UL listed. Manual motor starters can also be cULus listed, meaning that they are UL listed to US and Canadian safety standards. All the requirements of both UL and CSA are covered by cULus, so the product is then suitable for use in the US and in Canada.



## 1.4 CCC (China Compulsory Certification)

Since the manual motor starters standard is listed according to the CCC-regulation in China, it is mandatory to have the product approved and labelled with a CCC-mark to be allowed to be put on the Chinese market. The Chinese GB14048.2 and GB14048.4 standard is based on the IEC-standard IEC 60947-2 and IEC 60947-4-1.

## 1.5 Other local approvals based on IEC-standard

In addition to IEC and UL standards, many countries have their own local certifications. Some examples of the major ones besides the already mentioned CSA and CCC are listed below:

- **EAC** – The **Eurasian Conformity** mark for Russia, Ukraine etc.
- **RCM** – The **Regulatory Compliance Mark** for Australian & New Zealand
- **NOM** – The **Norma Oficial Mexicana**
- **KC** – The **Korea Certification** mark

## 1.6 Marine approvals

For manual motor starters used on board ships, maritime insurance companies sometimes require different marine certificates of approvals. Some examples include: DNV GL (Det Norske Veritas together with Germanischer Lloyd), BV (Bureau Veritas), LR (Lloyds Register EMEA) which are based on the IEC standard, or from ABS (the American Bureau of Shipping) which is based on UL standards or on some other independent certification organization. Typically, marine approvals have special requirements regarding shock, vibrations and humidity.

## 1.7 Potentially explosive atmospheres (ATEX)

Explosive atmospheres occur when flammable gases, mist, vapors or dust are mixed with air. This creates a risk of an explosion. The amount of a substance needed to create an explosive atmosphere depends on the substance in question. The area where this possibility exists is defined as a potentially explosive atmosphere. These atmospheres can be found throughout industries, from chemical, pharmaceutical, and food, to power, mining and wood processing. The areas may also be known as “hazardous areas” or “hazardous locations.”

### 1.7.1 International IECEx System

The IECEx System (<http://www.iecex.com/>) from the International Electrotechnical Commission, is a voluntary certification system that verifies compliance with IEC standards related to safety in explosive atmospheres. The IECEx System covers four main areas:

- Certification of service facilities
- IECEx equipment certification
- Ex marking conformity
- Certification of Personnel Competencies

### 1.7.2 IECEx Conformity Mark System

In order for equipment to receive a conformity “Ex” marking under the IECEx System, it must obtain a certificate of conformity. To obtain a certificate of conformity, there must be:

- An accepted IECEx Quality Assessment Report (QAR)
- An accepted IECEx Test Report for type testing (ExTR)

Products with the IECEx conformity mark have received the IECEx Certificate of Conformity, which confirms the product has the appropriate protection for use in explosive atmospheres and that it has been manufactured under a system subject to ongoing surveillance by certification bodies. The marking also indicates that the product can be supplied to the market without the need for additional testing. The exception is the increased safety (EX e) motor protection type, which must always be tested with the drive it is used with.

### 1.7.3 European Directives referred to ATEX

Commonly referred to as ATEX, from the French “ATmosphères EXplosibles”, this European Directives is a combination of two EU directives: The Worker Protection Directive 1999/92/EC and the Product Directive 2014/34/EU. This provides guidelines similar to the IECEx system, with a few exceptions, and without the certification of service facilities and certification of personnel competencies. Compliance with the “Essential Health and Safety Requirements” described in the directives is mandatory within the European Union countries. The easiest way to show compliance is to follow harmonized standards.

### 1.7.4 Potentially explosive atmospheres groups, zones, categories and devices

Within industries, all potentially explosive atmospheres are required to have an area classification referred to as the zone system. The zone system is used all over the world and nowadays also accepted as an alternative system in North America.

Authorities normally determine the area, but it can also be performed by a third party; a notified body or other expert. It is the owner’s responsibility to ensure that the classification of their site is performed before suitable products can be selected and installed at the location.

Globally, a zone system is used to classify potentially explosive areas. The Worker Protection Directive 1999/EC and the international standards IEC / EN 60079-10-x define these zones. In all cases, zone classification for potentially explosive atmospheres, zones, categories and devices are the responsibility of the owner of the site where the potentially explosive atmosphere exists.

There are 6 zones:

- **Zone 0** (for gas) and **20** (for dust), where there is a continuous presence of an explosive atmosphere.
- **Zone 1** (for gas) and **21** (for dust), where there is an occasional occurrence of a potentially explosive atmosphere.
- **Zone 2** (for gas) and **22** (for dust), where potentially explosive atmospheres can occur by accident, not during normal operation.

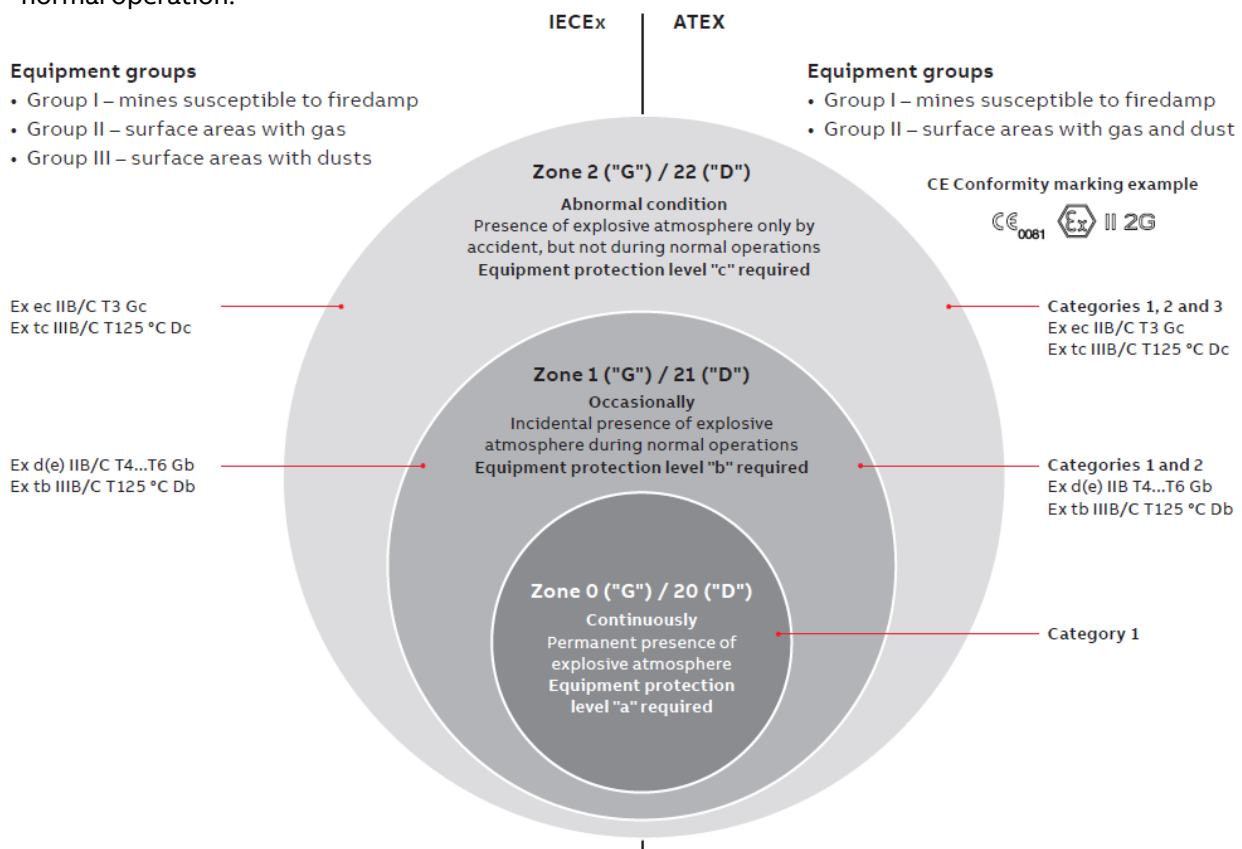

Figure 1: Potentially explosive atmosphere groups, zones, categories and devices. "G" = Gas; "D" = Dust

### 1.7.5 Equipment categories

Equipment categories are used in the ATEX directive. The category indicates which safety level must be used in each zone. In zone 0/20, category 1 devices must be used; in zone 1/21, category 2 devices; and in zone 2/22, category 3 devices. Classification into categories is particularly important, because all the inspection, maintenance and repair duties of the end user will depend on the category of the product/equipment, not on the zone where it is installed.

### 1.7.6 Equipment protection levels (EPL)

The latest revisions to the IEC and EN standards include the concept of “equipment protection levels” (EPLs), which identify products according to the ignition risk they might cause. The EPL also considers the potential consequences of an explosion. For zone 0/20, the equipment protection level required would be “a”; for zone 1/21, it would be “b”; and for zone 2/22, the level would be “c”.

### 1.7.7 Select the device type according to the zone and category/EPL

Standard IEC 60079-0 EN 60079-0		Zone according to IEC 60079-10-x EN 60079-10-x		ATEX Directive 2014/34/EU (previously 94/9/EC)	
Group	EPL	Protection level	Zones	Equipment group	Equipment category
<b>I</b> <b>(Mines)</b>	Ma	Very high	The zone classification is not used in mines	<b>I</b> <b>(Mines)</b>	M1
	Mb	High			M2
<b>II</b> <b>(Gas)</b>	Ga	Very high	0	<b>II</b> <b>(Surface)</b>	1G
	Gb	High	1		2G
	Gc	Enhanced	2		3G
<b>III</b> <b>(Dust)</b>	Da	Very high	20		1D
	Db	High	21		2D
	Dc	Enhanced	22		3D

Table 1: Select the device type according to the zone and category/EPL

### 1.7.8 Manual motor starters in potentially explosive atmospheres

Manual motor starters (e.g. MS132 and MS165) are authorized under device group II, category (2) in the "G" area (areas with potentially explosive gas, steam, smoke or air mixtures) and additionally for the "D" area (areas with combustible dust).

#### BVS 15 ATEX F 004



II (2) G      IECEx BVS 17.0070  
II (2) D      [Ex]

Manual motor starters are not suitable for installation and/or operation in potentially explosive areas. It is intended to protect a motor which is installed in the potentially explosive atmosphere. When using the devices in potentially explosive areas, preventive measures must be taken, e. g., operation within a suitable enclosure.

#### Notes:

- For explosion-proof applications, the efficiency of the installed protection devices must be verified prior to commissioning!
- The protection function of the device is the thermal overload protection and protection against short-circuits in the motor. In case of an overload trip, the motor is switched off by opening the main contacts of the manual motor starter.
- The safe state is the "tripped state", i.e., turning the handle to the 0-position or trip position.

## 1.8 Applied standards

Following standards are used or partly used for ABB's manual motor starters.

<b>International and European Standards</b>	<b>Title</b>
IEC / EN 60947-1	Low-voltage switchgear and controlgear - Part 1: General rules
IEC / EN 60947-2	Low-voltage switchgear and controlgear - Part 2: Circuit-breakers
IEC / EN 60947-4-1	Low-voltage switchgear and controlgear - Part 4-1: Contactors and motor-starters - Electromechanical contactors and motor-starters
IEC / EN 60947-5-1	Low-voltage switchgear and controlgear - Part 5-1: Control circuit devices and switching elements - Electromechanical control circuit devices
<b>Standards for north America</b>	<b>Title</b>
UL 60947-4-1 (formerly UL 508)	Low-voltage switchgear and controlgear - Part 4-1: Contactors and Motor-Starters - Electromechanical contactors and motor-starters
UL 60947-4-1A	2nd Ed. - Low-Voltage Switchgear and Controlgear – Part 4-1: Contactors and Motor Starters – Electromechanical Contactors and Motor-Starters
UL 60947-5-1	Low-Voltage Switchgear and Controlgear - Part 5-1: Control Circuit Devices and Switching Elements - Electromechanical Control Circuit Devices
<b>Standards for Canada</b>	<b>Title</b>
CSA C22.2 No.60947-1 (formerly CSA C22.2 No.14)	Low-voltage switchgear and controlgear - Part 1: General rules
CSA C22.2 No.60947-4-1 (formerly CSA C22.2 No.14)	Low-voltage switchgear and controlgear - Part 4-1: Contactors and motor-starters - Electromechanical contactors and motor-starters
<b>Standards for China</b>	<b>Title</b>
GB/T14048.2	Low-voltage switchgear and controlgear - Part 2: Circuit-breakers
GB/T14048.4	Low-voltage switchgear and controlgear - Part 4-1: Contactors and motor-starters - Electromechanical contactors and motor-starters
GB/T14048.5	Low-voltage switchgear and controlgear - Part 5-1: Control circuit devices and switching element - Electromechanical control circuit devices
<b>Standards for ATEX</b>	<b>Title</b>
IEC / EN 60079-0	Explosive atmospheres - Part 0: Equipment - General requirements
IEC / EN 60079-1	Explosive atmospheres - Part 1: Equipment protection by flameproof enclosures "d"
IEC / EN 60079-7	Explosive atmospheres - Part 7: Equipment protection by increased safety "e"
IEC / EN 60079-31	Explosive atmospheres - Part 31: Equipment dust ignition protection by enclosure "t"
IEC / EN EN 60079-14	Explosive atmospheres - Part 14: Electrical installations design, selection and erection

Table 2: Applied standards for the manual motor starter

## 2. General product overview

### 2.1 Basic function

Manual motor starters protect the motor and the installation against short-circuits and overloads. They are three pole electro-mechanical protection devices with a release for overload protection and short-circuit protection. Furthermore, they provide a disconnect function for safe isolation of the installation and the power supply and they can be used for switching loads ON and OFF manually.

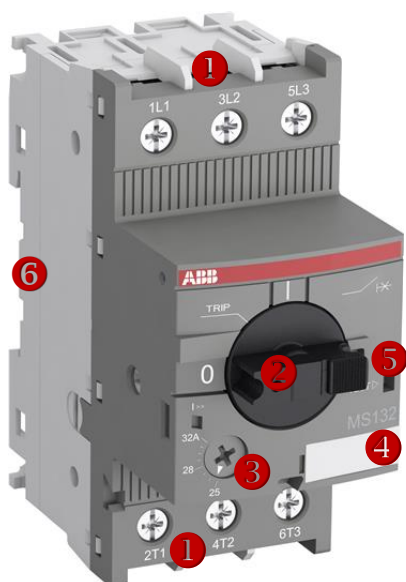

#### 1 Power terminals

They allow the connection of up to two conductors with different cross-sections for the main.

#### 2 ON/OFF handle (operator)

For switching ON and OFF; indication of a possible trip; with integrated shut-off device. Switching on and off must be done quickly and without interruption.

#### 3 Current setting dial

The dial makes it easy to set the device to the rated motor current.

#### 4 Label for marking

#### 5 TEST-Function

Allows testing of the trigger mechanism.

#### 6 DIN rail mounting

Allows mounting the device on DIN rails 35x15 mm and 35x7.5 mm.

Figure 2: Basic function shown on MS132

Manual motor starters are approved according IEC / EN 60947-2, IEC / EN 60947-4-1 and UL 60947-4-1A (previously UL 508). The protection function is realized with the following sub-functions:

- overload protection
- short-circuit protection
- phase loss sensitivity

Upon detection of a fault, the manual motor starter disconnects all phases from the supply, directly isolating the protected load. In addition, manual motor starters increase the device reliability by reacting quickly, protecting against damage to the load-side circuits and motor by operating within milliseconds following a short-circuit fault.

The term “manual motor starter” is not directly stated in either standard, with the terms for the UL “Manual Motor Controller” or “Combination Motor Controller” used as these terms refer to these devices. For the International Electrotechnical Commission (IEC), these devices are referred to as “motor protection circuit-breaker (MPCB)” or simply “circuit-breakers”.

Other common aliases for a manual motor starter include:

- motor-protective circuit-breakers (MPCB)
- manual motor protectors (MMP)
- manual motor controllers (MMC)
- manual starter protectors (MSP)
- motor circuit protectors (MCP)
- motor protection (MP)

### 2.1.1 Release (tripping element)

Manual motor starters fulfill trip classes in accordance with IEC 60947-4-1 and UL 60947-4-1A. The trip class indicates the maximum tripping time from a cold state. This tripping time refers to a steady symmetrical three-pole load with a 7.2x current setting.

Similar to molded case circuit-breakers (MCCB), standard manual motor starters are equipped with two releases:

- An adjustable, inverse time-delay overcurrent release for overload protection
- A fixed, instantaneous release for short-circuit protection

Magnetic only (MO) manual motor starters are equipped with an instantaneous short-circuit release. When combined with an external overload relay, this wiring schematic closely resembles that of conventional combination starters (e.g. circuit-breaker, contactor, and overload relay).

In the event of a motor overload, the overload relay trips and the contactor is switched OFF. However, the manual motor starter magnetic only stays switched ON. The magnetic only manual motor starter trips only in the event of a short-circuit and clears the fault. Consequently, this starter differentiates between overloads and short-circuits by means of separate signaling (does not apply to the MS116).

### 2.1.2 Time-current characteristics (tripping characteristics)

Tripping times in accordance with the harmonized IEC 60947-4-1, UL 60947-4-1A and CSA C22.2 No. 60947-4-1 standards can be seen in the figures below. The tripping characteristics of the inverse time-delay thermal over-current release applies for direct current (DC) and alternating current (AC) with frequencies of 50/60 Hz.

For three-pole loads and currents of between 3 - 8 times the set current, the tolerance of the tripping time is  $\pm 20\%$ .

The tripping characteristics of the instantaneous short-circuit releases is based on the rated operational current  $I_e$ , which, in the case of the manual motor starter is the same as the upper value of the setting range. Lower current settings result in a higher multiple for the tripping current of the instantaneous short-circuit releases. The tripping characteristic curves are valid for the cold state; and the warm state, while the tripping times of the inverse time-delay thermal over-current release have a higher spread.

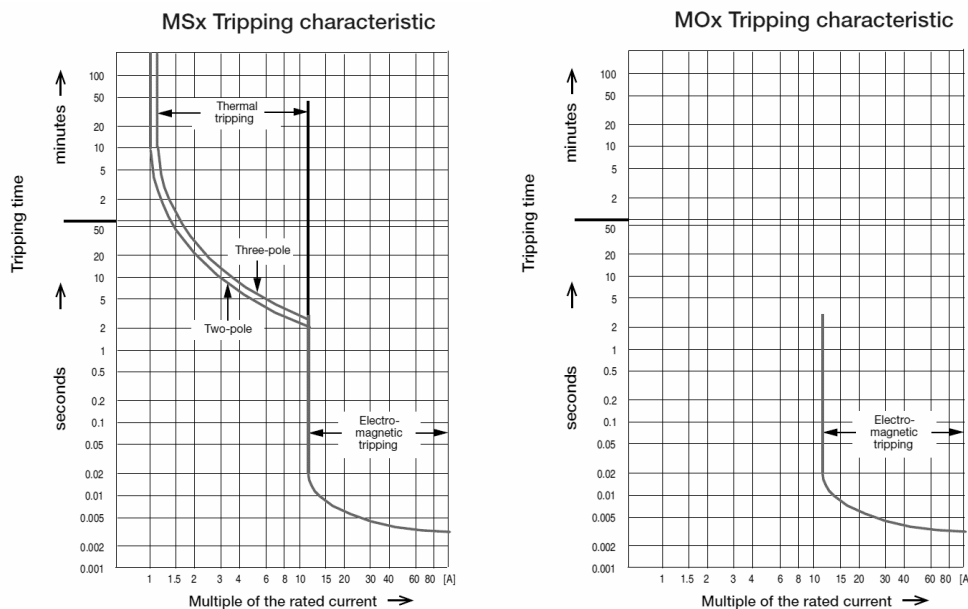

Figure 3: Tripping diagram for the MSx and MOx.

Tripping curves for manual motor starters are easily accessible at ABB’s Download Center.

<https://library.abb.com/> > All Categories > Products > Low Voltage Products and Systems > Control Product > Manual Motor Starters

### 2.1.3 Overload protection

An overload is defined as an operating condition in an electrically damaged circuit which causes an overcurrent. In compliance with international and national standards, manual motor starters have a setting scale in amperes, which allows the device to be adjusted directly without any additional calculation. In compliance with international and national standards, the setting current is the rated current of the motor and not the tripping current (no tripping at  $1.05 \times I$ , tripping at  $1.2 \times I$  after 2 hours;  $I$  = setting current).

### 2.1.4 Overload trip classes

ABB manual motor starters fulfill their trip classes in accordance with IEC 60947-4-1 and UL 60947-4-1A. The trip class of a manual motor starter indicates the maximum tripping time from a cold state. This tripping time refers to a steady symmetrical three-pole load with a 7.2x current setting.

Tripping times in accordance with IEC 60947-4-1 and UL 60947-4-1 can be seen in the figures “Tripping characteristics”.

Class	Tripping time $T_p$ [s] at $7.2 \times I_e$
10A	$2 < T_p \leq 10$
10	$4 < T_p \leq 10$
20	$6 < T_p \leq 20$
30	$9 < T_p \leq 30$

Table 3: The information above is based on IEC 60947-4-1 and is intended for reference only.

### 2.1.5 Short-circuit protection

A short-circuit is defined as an accidental or intentional conductive path between two or more conductive parts forcing the electrical potential between these conductive parts to be equal to, or close to, zero. The short-circuit release is set at a fixed multiple value (non-adjustable) of the manual motor starter’s rated operational current  $I_e$ .

The short-circuit releases of the manual motor starter disconnect the load from the grid in each of short-circuits, thus preventing further damage. With a short-circuit breaking capacity up to 100 kA at a voltage of 400 V AC, the manual motor starter is considered to be short-circuit proof if higher short-circuit currents are not to be expected at the installation site of the devices.

#### 2.1.5.1 Short-circuit coordination

The main task of the short circuit protection device is the rapid detection, limiting and switching off of high fault currents and limiting the damage to the short circuit location.

If you want to ensure that no components are unduly loaded or damaged by the short circuit current shutdown, mutual coordination of the starter components contactor and circuit-breaker is necessary. The short-circuit coordination between switching and protection devices covers the electro-physical processes of all components loaded in the event of a short circuit.

#### 2.1.5.2 Definition according to IEC 60947-4-1

Coordination type 1:

- In the event of a short circuit, the contactor or the starter must not endanger persons and equipment.
- The contactor or the starter need not be suitable for further operation without repair and partial renewal.
- Damage to the contactor and the overload relay is permitted.

Coordination type 2:

- In the event of a short circuit, the contactor or the starter must not endanger persons and equipment.
- The contactor or starter must be suitable for further use.
- The overload relay or other parts must not be damaged, except for the welding of the contactor or starter contacts, if they are easy to disconnect without appreciable deformation (for example with a screwdriver).

For additional information to select the right short-circuit coordination type, please use the Selected Optimized Coordination (SOC) selection tool (<http://applications.it.abb.com/SOC/page/selection.aspx>).

### 2.1.6 Phase loss sensitivity

Phase loss sensitivity is a characteristic of an inverse time-delay and thermal over-current releases. A strong imbalance between phases can damage motors and other loads. Manual motor starters are designed to detect these conditions and trip to prevent load-side circuit and motor damage.

### 2.1.7 Single-phase and direct current (DC) loads

In order for manual motor starters to protect single-phase loads or direct current (DC) loads, all three main poles must be connected in series (see figures below).

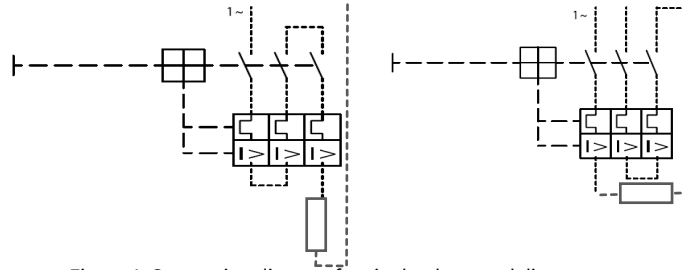

Figure 4: Connection diagram for single-phase and direct current.



## 2.2 Terms and ratings

### 2.2.1 Rated operational voltage ( $U_e$ )

The rated operational voltage of a manual motor starter is a value of phase-to phase voltage which determines the possible application of the manual motor starter. This voltage needs to be considered in combination with a rated operational current.

### 2.2.2 Rated short-circuit making capacity ( $I_{cm}$ )

The rated short-circuit making capacity (current, voltage) is the short-circuit current that a manual motor starter can make at a rated operational voltage, rated frequency and a fixed power factor. It is expressed as the maximum prospective peak current.

### 2.2.3 Rated short-circuit breaking capacity

The rated short-circuit breaking capacity (current, voltage) is the short-circuit current that a manual motor starter can break at rated operational voltage, rated frequency and a fixed power factor. It is expressed as the maximum prospective peak current. It is expressed as the rated ultimate short-circuit breaking capacity or rated service short-circuit breaking capacity.

#### 2.2.3.1 Rated ultimate short-circuit breaking capacity ( $I_{cu}$ ) acc. to IEC / EN 60947-2

This is the maximum short-circuit breaking capacity (current, voltage) that manual motor starter can interrupt without being damaged. After the short-circuit interruption, in the event of an overload, the manual motor starter is able to trip with increased tolerances.

#### 2.2.3.2 Rated service short-circuit breaking capacity ( $I_{cs}$ ) acc. to IEC / EN 60947-2

This is the short-circuit breaking capacity (current, voltage) that manual motor starters can repeatedly interrupt without being damaged. After the short-circuit interruption, the manual motor starter is able to carry the rated operational current and to trip in the case of an overload.

#### 2.2.3.3 What are the difference between the rated ultimate short-circuit breaking capacity ( $I_{cu}$ ) and rated service short-circuit breaking capacity ( $I_{cs}$ )

The difference between rated ultimate short-circuit breaking capacity  $I_{cu}$  and rated service short-circuit breaking capacity  $I_{cs}$  is the test sequence in IEC / EN 60947-2:

- Part 8.3.4 Test sequence II: Rated service short-circuit breaking capacity
- Part 8.3.5 Test sequence III: Rated ultimate short-circuit breaking capacity

The test sequence for  $I_{cu}$  is O-t-CO. In this sequence manual motor starter has to switch off a short-circuit (“O”), remain off for 3 minutes (“t”) and then it is switched again on this short-circuit in order to switch it off (“CO”). In this case the overload characteristic curve can change for a longer period of time and the manual motor starter does not have the full current-carrying capacity.

The test sequence for  $I_{cs}$  is O-t-CO-t-CO. In this sequence the manual motor starter has to switch off the short-circuit (“O”), have a 3-minute break (“t”), switch on the existing short-circuit and switch it off again (“CO”), have another 3-minute break (“t”), switch on the existing short-circuit again and switch it off again (“CO”). After that, the manual motor starter must be able to carry the full current and the overload characteristic curve must not change permanently.

### 2.2.4 Rated short-time withstand current ( $I_{cw}$ )

The rated short-time current an item of equipment can withstand is the value of the short-time withstand current, which the equipment can carry without damage under the test conditions specified in the relevant product standard.

## 2.2.5 Selectivity categories

The IEC 60947-2 defines two different selectivity categories of low-voltage circuit-breakers:

- Category A = Circuit-breakers not specifically intended for selectivity under short-circuit conditions, which typically do not have any intentional short-time delay. The short-time withstand current is not taken into account.
- Category B = Circuit-breakers specifically intended for selectivity under short-circuit conditions. ABB manual motor starters are all selectivity category A. Such breakers must have the possibility for a short-time delay and also specify a minimum value short-time withstand current rating according to standard.

## 2.2.6 Ambient air temperature compensation

Ambient air temperature compensation is realized by utilizing a bimetal which counteracts the working bimetals of the inverse time-delay thermal over-current release. This second bimetal is not heated by the motor current but bends only under the influence of the ambient air temperature. As a result, the influence of the ambient air temperature on the tripping characteristics of the manual motor starter is automatically compensated for, at an ambient temperature of 20°C.

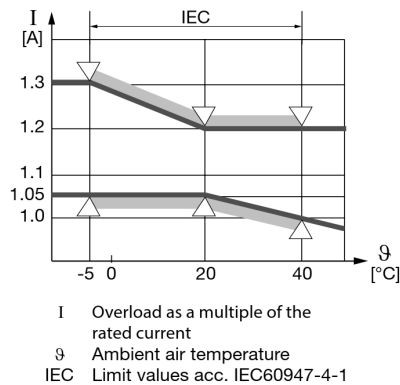

Figure 5: Diagram for the Ambient air temperature compensation.

The ambient air temperature compensation is defined in IEC / EN 60947-4-1 within a temperature range from -5 to +40 °C. The ABB manual motor starters have a temperature compensation from -25°C up to +60°C.

## 2.2.7 Temperature rise of the manual motor starter

ABB tests the manual motor starters according to the Standard IEC 60947-1 table 2 and 3. This table indicates the maximum temperature rise of the manual motor starters. Here you will find some example for the temperature rise:

<b>Terminal material</b>	<b>Temperature-rise limits <sup>a, c</sup> in Kelvin [K]</b>
<b>Bare copper</b>	60
<b>Bare brass</b>	65
<b>Tin plated copper or brass</b>	65
<b>Silver plated or nickel-plated copper or brass</b>	70
<b>Other metals</b>	b

a The use in service of connected conductors significantly smaller than those listed in Tables 9 and 10 could result in higher terminals and internal part temperatures and such conductors should not be used without the manufacturer's consent since higher temperatures could lead to equipment failure.  
 b Temperature-rise limits to be based on service experience or life tests but not to exceed 65 K.  
 c Different values may be prescribed by product standards for different test conditions and for devices of small dimensions, but not exceeding by more than 10 K the values of this table.

Table 4: Table 2 from IEC 60947-1 Temperature-rise limits of terminals

<b>Accessible parts</b>	<b>Temperature-rise limits <sup>a</sup> in Kelvin [K]</b>
<b>Manual operating means:</b>	
Metallic	15
Non-metallic	20
<b>Parts intended to be touched but not hand-held:</b>	
Metallic	30
Non-metallic	40
<b>Parts which need not be touched during normal operation b:</b>	
Exteriors of enclosures adjacent to cable entries:	
Metallic	40
Non-metallic	50
Exterior of enclosures for resistors	200b
Air issuing from ventilation openings of enclosures for resistors	200b

A Different values may be prescribed by product standards for different test conditions and for devices of small dimensions but not exceeding by more than 10 K the values of this table.  
 b The equipment shall be protected against contact with combustible materials or accidental contact with personnel. The limit of 200 K may be exceeded if so stated by the manufacturer. Guarding and location to prevent danger is the responsibility of the installer. The manufacturer shall provide appropriate information, in accordance with 5.3.

Table 5: Table 3 from IEC 60947-1 Temperature-rise limits of accessible parts.

### 2.2.8 Trip-free mechanism

As required by IEC 60947-1, the manual motor starter features a trip-free mechanism. This means that the manual motor starter trips even if the handle is locked in the “ON” position or held by hand. According to IEC 60204, a supply disconnecting device also requires a trip-free mechanism.

### 2.2.9 Phase loss sensitivity

According to IEC 60947-1-4-1, phase loss sensitivity is a characteristic of an inverse time-delay thermal over-current release. In the case of a loss of incoming power or a strong imbalance of the phases, this ensures that the manual motor starter trips.

Timely tripping in the event that a two-phase supply is too long prevents an over current in the remaining phases, which could damage the motor or other loads.

<b>Limits of operation</b>	
<b>No tripping within 2 hours</b>	2 Pole: $1.0 \times I_e$ 1 Pole: $0.9 \times I_e$
<b>Tripping within 2 hours</b>	2 Pole: $1.15 \times I_e$ 1 Pole: $0 \times I_e$

Table 6: The information above is based IEC 60947-4-1

During normal operation, the device should be symmetrically loaded on all three poles to prevent early tripping due to phase loss sensitivity. In order to protect single-phase or direct-current devices, all three main poles have to be connected in series, see also Chapter: 2.1.7 Single-phase and direct current (DC) loads.

### 2.2.10 Mechanical and electrical durability

Due to product design characteristics, manual motor starters vary in regard to the number of electrical and mechanical operations which can be sustained over the product life. Below is a comparison between manual motor starters, contactors and circuit-breakers.

<b>Rating</b>	<b>Manual motor starters</b>	<b>Contactors &lt; 100 Amps</b>	<b>Circuit-breakers</b>
Mechanical durability	Up to 100,000	>10,000,000	25,000
Electrical durability	Up to 100,000	>1,000,000	8,000

Table 7: Examples of mechanical and electrical durability

Since molded case circuit-breakers are designed to protect circuits and loads rather than control them, the mechanical and electrical durability of these devices is quite low. Contactors which are designed specifically for load control have very high mechanical and electrical durability. Manual motor starters which are designed to provide both control and protection are rated higher than general circuit-breaker types.

## 2.3 Switch and breaker types

Below is a description of the devices for the correct selection, these are applicable for the manual motor starter:

- Motor protection circuit-breaker
- Circuit-breaker
- Load Switch
- Disconnect switch

### 2.3.1 Motor protection circuit-breaker

Usually this means a device especially for the overload protection of motors. In smaller current ranges the motor protection switch often serves directly as a manual operation switch. In its original form, it only had a low short-circuit breaking capacity. Today, the term motor circuit-breaker is also understood to mean a circuit-breaker with motor protection characteristic

### 2.3.2 Circuit-breaker

The circuit-breaker is a mechanical switching device that can switch on, conduct and switch off currents under operating conditions in the circuit, and can also switch on under specified exceptional conditions, such as a short-circuit, for a specified period of time, and switch off (IEC 60947-1).

### 2.3.3 Load switch

The load switch is a mechanical switch that can switch on, conduct and switch off currents under normal conditions in the circuit, including a specified operational overload, and can also operate under specified exceptional conditions, such as short circuits, for a specified period of time.

A load switch may have a short circuit breaking capacity but does not need to have a short circuit breaking capacity (IEC 60947-1). Short-circuit currents can be conducted (high short circuit resistance), but not switched off.

### 2.3.4 Disconnect switch

The disconnect switch is a mechanical switching device that in the open position meets the requirements specified for the disconnection function (IEC 60947-1). The disconnection function is to switch off the power supply to the entire system or part of the system, whereby the system or part of the system is disconnected from any electrical energy source for safety reasons. Important here is the opening distance. The electrical separation from pole to pole and from input to output must be ensured, this is realized by a visible disconnection point or the device-internal (mechanical locking device) by appropriate constructive measures.





A device fulfills the isolating characteristic according to IEC 60947-1 if, in the "open" position, it ensures an isolating distance in which the specified dielectric strength between the open contacts of the main circuit of the switching device is fulfilled. It must also be equipped with a display device with respect to the position of the movable contact pieces. This switch position indicator must be securely connected to the actuator, which may serve as a switch position indicator, provided that it can only indicate the open position in the "released" position when all movable contacts are in place the "open" position.

A disconnecter must be able to open and close a circuit only when either a current of negligible magnitude is turned off or on, or when there is no appreciable voltage difference between the two terminals of each current path. Devices fulfilling the "disconnecting function" are marked in the front with the following symbol: 

## 2.4 Product offering

ABB provides a comprehensive manual motor starter. Worldwide the manual motor starters device types are divided into three ranges to simplify selection, coordination, and installation:

- MS116 with a standard performance range up to 32 A
- MS132 / MO132 with high performance ranges up to 32 A
- MS165 / MO165 with high performance ranges up to 80 A
- MS132-T with high performance ranges for transformer protection

	 <b>MS116</b>	 <b>MS132 MS132-K</b>	 <b>MS165</b>	 <b>MS132-T MS132-KT</b>
<b>Thermal protection</b>	X	X	X	X
<b>Electromagnetic protection</b>	X	X	X	X
<b>Phase loss sensitivity</b>	X	X	X	X
<b>Switch position</b>	ON/OFF	ON/OFF/TRIP	ON/OFF/TRIP	ON/OFF/TRIP
<b>Magnetic trip indication</b>		X	X	X
<b>Lockable handle without accessories</b>		X	X	X
<b>Disconnection function</b>	X	X	X	X
<b>Width</b>	45 mm	45 mm	55 mm	45 mm
<b>Rated operational current I<sub>e</sub></b>	0.1 ... 32 A	0.1 ... 32 A	10 ... 80 A	0.1 ... 25 A
<b>Short circuit breaking capacities</b>	up to 100 kA	up to 100 kA	up to 100 kA	up to 100 kA
<b>Ambient air temperature (w/o derating)</b>	-25 ... +55 °C	-25 ... +60 °C	-25 ... +60 °C	-20 ... +60 °C



	 <b>MO132</b>	 <b>MO165</b>
<b>Thermal protection</b>		
<b>Electromagnetic protection</b>	X	X
<b>Phase loss sensitivity</b>		
<b>Switch position</b>	ON/OFF/TRIP	ON/OFF/TRIP
<b>Magnetic trip indication</b>		
<b>Lockable handle without accessories</b>	X	X
<b>Disconnection function</b>	X	X
<b>Width</b>	45 mm	55 mm
<b>Rated operational current I<sub>e</sub></b>	0.1 ... 32 A	10 ... 80 A
<b>Short circuit breaking capacities</b>	up to 100 kA	up to 100 kA
<b>Ambient air temperature (w/o derating)</b>	-25 ... +60 °C	-25 ... +60 °C

Table 8: Product range of all manual motor starters.

### 2.4.1 MS116

The MS116 is a compact and economic range for motor protection up to 15 kW (400 V) / 32 A in width of 45 mm. Further features are the build-in disconnect function, temperature compensation, trip-free mechanism and a rotary handle with a clear switch position indicator. The manual motor starter is suitable for three- and single-phase applications. Auxiliary contacts, signaling contacts, undervoltage releases, shunt trips, power in-feed blocks and locking devices for protection against unauthorized changes are available as accessories. These are suitable throughout the MS116/MS132/MS165-range.

### 2.4.2 MS132

The MS132 are manual motor starters with thermal and electromagnetic protection for rated operational currents  $I_e$  from 0.10 to 32 A. Just like the MS116, the MS132 offer motor protection up to 15 kW (400 V AC) / 32 A and has a module width of 45 mm. This type has also a clear and reliable indication of fault in a separate window in the event of short-circuit tripping. Further features are the built-in disconnect function, temperature compensation, trip-free mechanism and a rotary handle with a clear switch position indicator. The manual motor starter is suitable for three- and single-phase applications. The handle is lockable to protect against unauthorized changes. Auxiliary contacts, signaling contacts, undervoltage releases, shunt trips, and power in-feed blocks are available as accessories. This manual motor starter offers a rated service short-circuit breaking capacity  $I_{cs} = 100$  kA at 400 VAC and trip class of 10. The handle is lockable to protect against unauthorized changes. Auxiliary contacts and signaling contacts are available as accessories.

#### 2.4.2.1 MS132-K

The MS132-K manual motor starter is similar to the MS132 but with Push-in spring terminals. You can connect rigid cables or ferruled cables simply by pushing them into the cable holes – there is no need to use any tools. For small cable cross-sections or for cables without ferrules simply push a screwdriver into the clearly marked holes to open the terminal. Also, this device has thermal and electromagnetic protection for rated operational currents  $I_e$  from 0.10 to 32 A. Like the MS116 and MS132, the MS132-K offers motor protection up to 15 kW (400 V AC) and has a module width of 45 mm.

### 2.4.3 MS165

The MS165 are manual motor starters with thermal and electromagnetic protection which are designed for significantly higher currents than the MS116 or MS132, namely from 10 to 80 A. The MS165 offers motor protection up to 30 kW (400 V AC) with a module width of 55 mm. Otherwise the device has all the features of the MS132.

### 2.4.4 MS132-T and MS132-KT

The MS132-T (screw terminals) and MS132-KT (Push-in spring terminals) are circuit-breakers for transformer protection with thermal and electromagnetic protection for rated operational currents  $I_e$  from 0.10 to 25 A. The MS132-T has the same module width of 45 mm as the MS132 and differs from it by using other releases. Sizes 1 and 2 also correspond to those of the MS132. The short circuit current setting is fixed to 20 times the operating current to handle the high inrush current generated by transformers. This version of the manual motor starter should not be used for motors.

### 2.4.5 MO132 and MO165

MO stands for "magnetic only", accordingly the MO132 and MO165 are manual motor starters with exclusively electromagnetic protection. The rated operational currents, the short circuit breaking capacity and module width correspond to the respective devices of the manual motor starter series. Since thermal tripping is not provided for the MO devices, the transmission slider, transmission lever, current adjusting slider, compensation bimetal, current setting holder and parts of the magnetic trip indication are not mounted. Otherwise, the configuration corresponds to the manual motor starter devices.

More information about the ABB manual motor starters are easily accessible at ABB's Download Center (<https://library.abb.com>) All Categories > Products > Low Voltage Products and Systems > Control Product > Manual Motor Starters

## 2.4.6 Accessories and enclosures

Since manual motor starters combine the functions of multiple components, such as circuit-breakers, disconnect switches, and overload relays, they are offered with many of the same types of accessories. Thus, the manual motor starters can be extended with auxiliary contacts which can be connected either on the side or - especially to save space - on the front. Also, undervoltage releases are available, and shunt releases complement the product range. With the help of separately available adapters can the manual motor starter easily and quickly, build to a compact starter combinations of motor protection switch and contactor.

<b>Signaling and status indication</b>	Auxiliary contacts <b>HK1, HKF1</b>	
	Signal contact alarms <b>SK1</b>	
	Short-circuit signaling contact <b>CK1</b>	
<b>Increasing functionality</b>	Undervoltage releases <b>UA1</b>	
	Shunt trips <b>AA1</b>	
	Current limiters <b>S803W</b>	
<b>Reducing installation time and saving space</b>	Three-phase busbar <b>PSx</b>	
	Feeder (in-feed) terminal blocks <b>S1-Mx</b>	
	Connecting Link <b>BEA</b>	
<b>External operation and enclosures</b>	Handles and shafts, NEMA Types 1, 3R, 12	
	Shaft alignment accessories	
	Door-mount kits, NEMA Type 12 <b>DMS132</b>	
	Enclosures, NEMA Type 12 <b>IB132</b>	

Auxiliary and signaling contacts can be combined to provide external status indication for a variety of conditions and states. The table below shows an overview of the functionality of these contact types.

Contact type			Condition / state of manual motor starter					
			OFF	ON	Signaling contact	Short-circuit trip	Undervoltage release	Shunt trip
<b>HK1, HKF1</b> <i>Auxiliary contacts</i>	Change position with the main contacts	Normally-open	O	X	O	O	O	O
		Normally-closed	X	O	X	X	X	X
<b>SK1</b> <i>Signal contact alarms</i>	Signals tripping by short-circuit or overload	Normally-open	O	O	X	X	X	X
		Normally-closed	X	X	O	O	O	O
<b>CK1</b> <i>Short-circuit indicators</i>	Signals tripping by short-circuit	Normally-open	O	O	O	X	O	O
		Normally-closed	X	X	X	O	X	X

O = Open; X = Closed

Table 9: Condition / state of manual motor starter.



2.4.6.1 Building rules for manual motor starters with accessories

The maximum capacity for MS116, MO132 and MS165

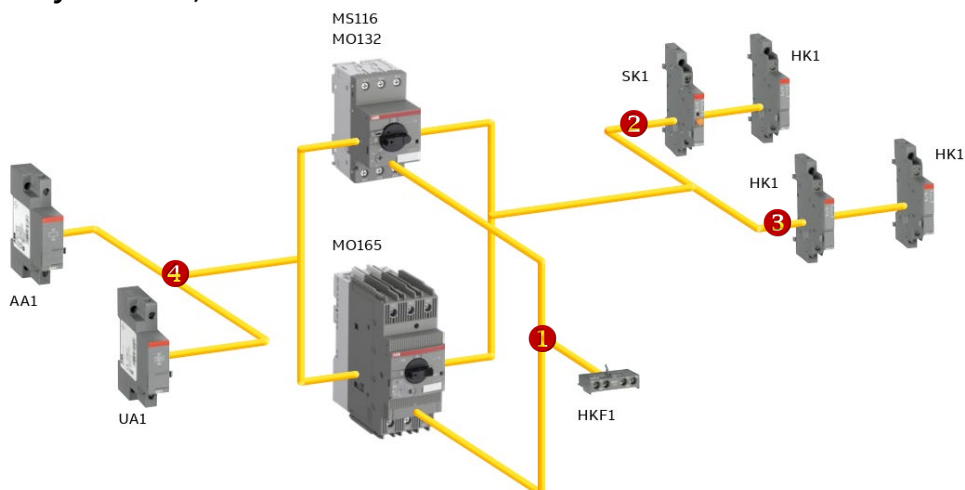

Figure 6: The maximum capacity for MS116, MO132 and MS165

- ① One front mounting auxiliary contact HKF1,
- Two accessories mounted on the right:
  - ② one SK1 signal contact alarm and one HK1 auxiliary contact
  - ③ or two HK1 auxiliary contacts
- ④ One AA1 shunt trip or one UA1 undervoltage release on the left side

The maximum capacity for MS132 or MS165

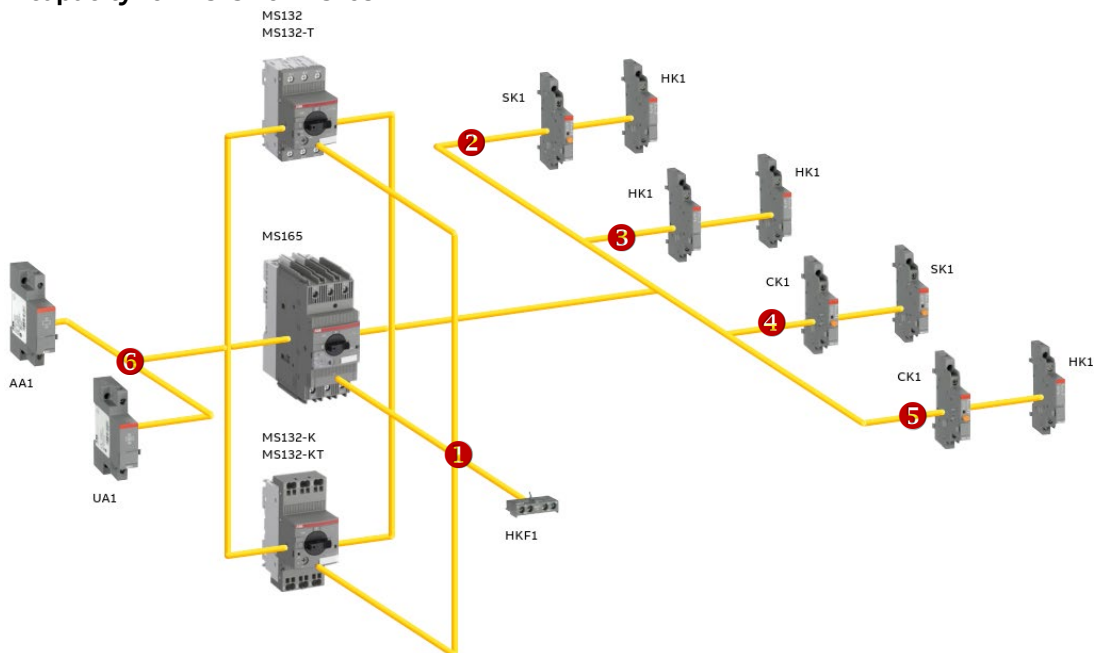

Figure 7: The maximum capacity for MS132 or MS165

- ① One front mounting auxiliary HKF1 contact,
- Two accessories mounting on the right:
  - ② one SK1 signal contact alarm and one auxiliary HK1 contact
  - ③ or two auxiliary HK1 contacts
  - ④ or one short-circuit CK1 indicator and one SK1 signal contact alarm
  - ⑤ or one CK1 short-circuit indicator and one auxiliary HK1 contact
- ⑥ One AA1 shunt trip or one undervoltage UA1 release on the left side (note: The combination of MS132-K + UA1 + CK1 is not possible)

### 2.4.6.2 Auxiliary contacts HK1 und HKF1

Auxiliary contacts HK1 and HKF1 change position with the main contacts of the manual motor starter. They open and close a separate circuit depending on the position of the manual motor starter. The interface on the main device is the breaker. The HK1 is mounted laterally on the right side of manual motor starter and the HKF1 is mounted on the front side.

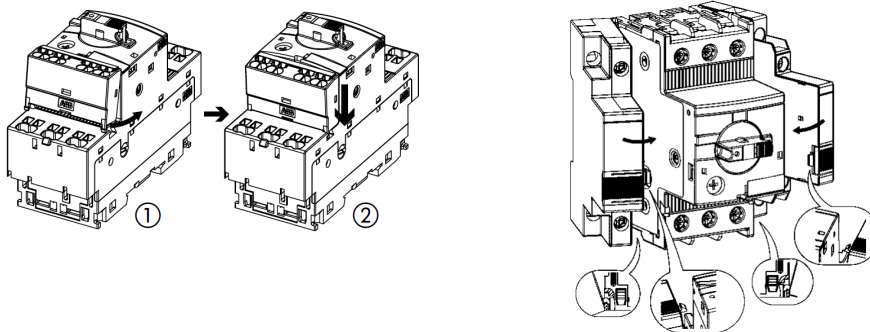

Figure 8: Auxiliary contacts HK1 und HKF1.

Auxiliary contacts are available in various versions as normally open or normally closed contacts. From the designation of the auxiliary contact, it can be seen whether it acts as an NC or NO contact. While HK1-11 and HKF1-11 have an opening and a closing contact, HK1-20 and HKF1-20 have just two NO contacts.

### 2.4.6.3 Signaling contacts SK1 and CK1

Signaling contacts signal the tripping of the manual motor starter with the protruding orange button. The SK signaling contact signals tripping regardless if it was caused by short-circuit or an overload. The CK signaling contact signals tripping in case it was caused by short-circuit. Both signaling contacts are attached on the right side of the main device and have a test function, which is activated by engaging in an opening window on the front of the unit with a screwdriver.

Like auxiliary contacts, signaling contacts are also available as normally open or normally closed contacts. The nomenclature of the type designation corresponds to the logic of the auxiliary contacts.

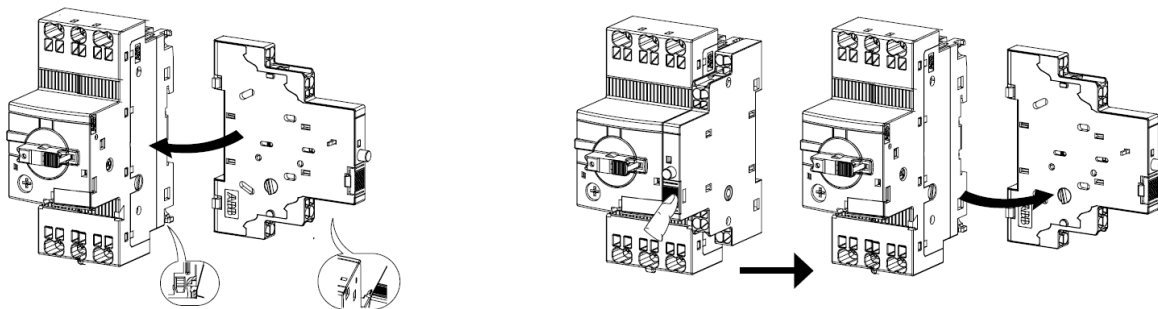

Figure 9: Signaling contacts SK1 and CK1.

#### 2.4.6.4 Shunt release AA1

The AA1 shunt release has a different direction of action to the UA1. The tripping occurs when a supply current is applied. Thereby the anchor is attracted and rotates the transfer lever via the slider. In accordance with the basic IEC 60947-1 standard, the manual motor starter must be switched off by the AA1 if the supply voltage of the shunt release measured during the tripping operation remains between 70% and 110% of the rated control circuit supply voltage.

#### 2.4.6.5 Under-voltage release UA1

The UA1 under-voltage release releases the manual motor starter or prevents it from being switched on when its voltage supply is interrupted. This can be used in emergency switching circuits or can prevent an automatic restart after voltage interruption.

The basic IEC 60947-1 standard defines the following limits of operation for under-voltage releases:

- When 35% of the rated voltage is applied to the UA1, it must not be possible to switch the manual motor starter on
- When 85% of the rated voltage is applied to the UA1, it must not be possible to switch the manual motor starter on
- If the rated voltage goes down, a switched-on manual motor starter must be switched off, over the UA1, at a voltage between 70% and 35% of the rated voltage

**2.4.6.6 Busbars**

Manual motor starters are often built together with contactors for different starter combinations. Three-phase busbars with associated feeder terminals ensure a quick and safe connection for several manual motor starters.

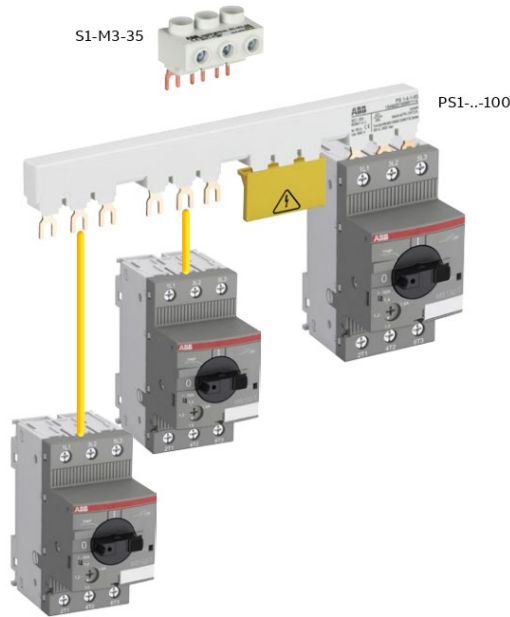

Figure 10: Manual motor starters with busbars

As main accessories for MS116, MS132, MO132, MS132-T, there are three-phase busbars up to 65 A and up to 100 A, as well as feeder terminals for 25 mm<sup>2</sup> and 35 mm<sup>2</sup> rated cross sections. Between 2 and 5 manual motor starters with none, one or two lateral auxiliary contacts can be connected. MS165 and MO165 use three-phase busbars for 125 A. Two, three or four manual motor starters with none, one or two lateral auxiliary contacts can be connected.

**2.4.6.7 Handles and shafts**

With this solution utilizing a door coupling rotary mechanism it is possible to operate a manual motor starter in the back of a switch cabinet from the outside. The complete mechanism includes the handle, shaft, driver, and shaft alignment ring and shaft supporter.

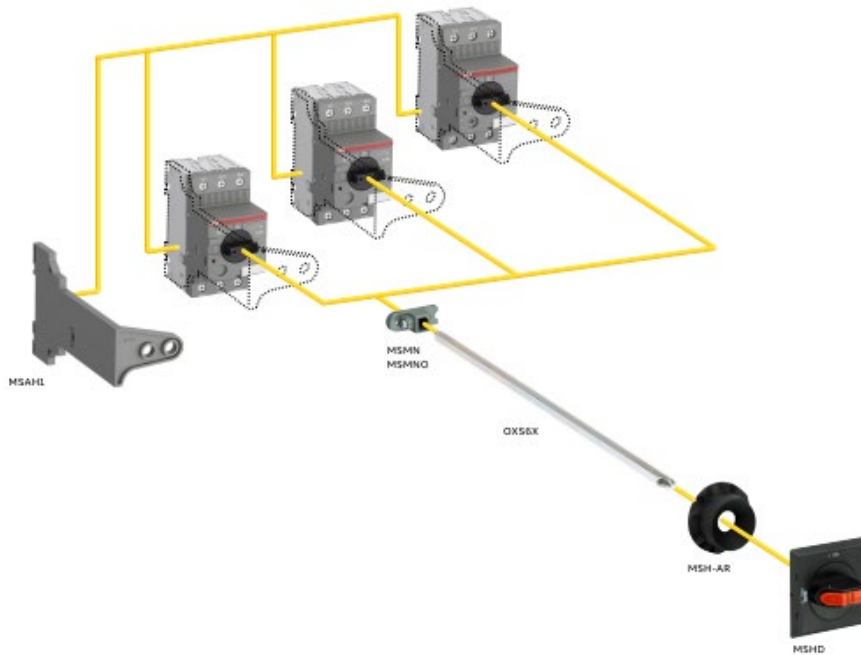

Figure 11: Manual motor starter with Handles and shafts.

### 3. Load types

Although the name suggests that their suitable application is limited only to motors, manual motor starters can additionally be used for controlling and protecting other types of loads, such as heaters. When combined with an additional controller, the applications for manual motor starters are even broader. The table below shows the tested ratings for ABB manual motor starters and AF contactors.

Tested ratings for manual motor starters	Tested ratings for contactors < 100 Amps
— AC-1: General use	— AC-1: General use
— AC Motors	— AC Resistance Air Heating (100,000 electrical cycles)
— AC-3: Squirrel-cage motors: starting, switches off motors during running time	— AC Motors
— AC-4: Squirrel-cage motors: starting, plugging, inching	— Elevator control, AC Motors (500,000 electrical cycles)
— DC-1: Non-inductive or slightly inductive loads, resistance furnaces, heaters	— AC-5a: Electric discharge lamps (ballast)
— DC-3: Shunt-motors, starting, plugging (1), inching (2), dynamic braking of motors	— AC-5b: Incandescent lamps (tungsten)
— DC-5: Series-motors, starting, plugging (1), inching (2), dynamic braking of motors	— AC-8a: Hermetic refrigerant compressors
	— DC-1: General use
	— DC Motors

Table 10: Load types

#### 3.1 General use and heaters

The harmonized utilization category AC-1 covers general and resistive type loads. This includes non-inductive or slightly inductive loads, as well as resistance furnaces and heaters. Additional ratings, such as “Resistance Air Heating” and “CSA Electrical Heating Control”, which require additional electrical cycling, can be performed to further validate control devices for use in heating applications. However, the general use AC-1 rating is sufficient for most heating applications.

ABB manual motor starters are suitable for manual control and the protection of heating loads. Magnetic only (MO) types can be selected when additional overload protection is not required.

### 3.2 Motors

Due to their high inrush peaks, locked rotor currents, and high potential for overheating, motor loads represent one of the most demanding load types. The figures below show an overview of an across-the-line motor start-up. The starting current is a characteristic of the motor. The starting time is a function of the load torque, inertia and motor torque and is influenced by the motor technology. As the starting current ratio ( $6-13 \times I_e$ ) is higher than the rated operational current  $I_e$ , an excessively long starting or braking period can cause an overload (temperature rise) in the motor. This can create electromechanical stresses or damage the motor's insulation if it is not properly protected.

There are many different manufacturers represented on the market, selling at various prices. Not all motors have the same performance and quality as motors from ABB, for example. High efficiency enables significant savings in energy costs during the motors' normal endurance. In the IEC 60034-30 standard for rotating electrical machines, four different efficiency classes have been defined. The classes are called IE1, IE2, IE3 and IE4, where motors belonging to IE4 are the most efficient. See the graph below for details. A low level of noise is something else that is of interest today, as well as the ability to withstand severe environments. There are also other parameters that differ. The design of the rotor affects the starting current and torque and the variation can be quite large between different manufacturers for the same power rating.

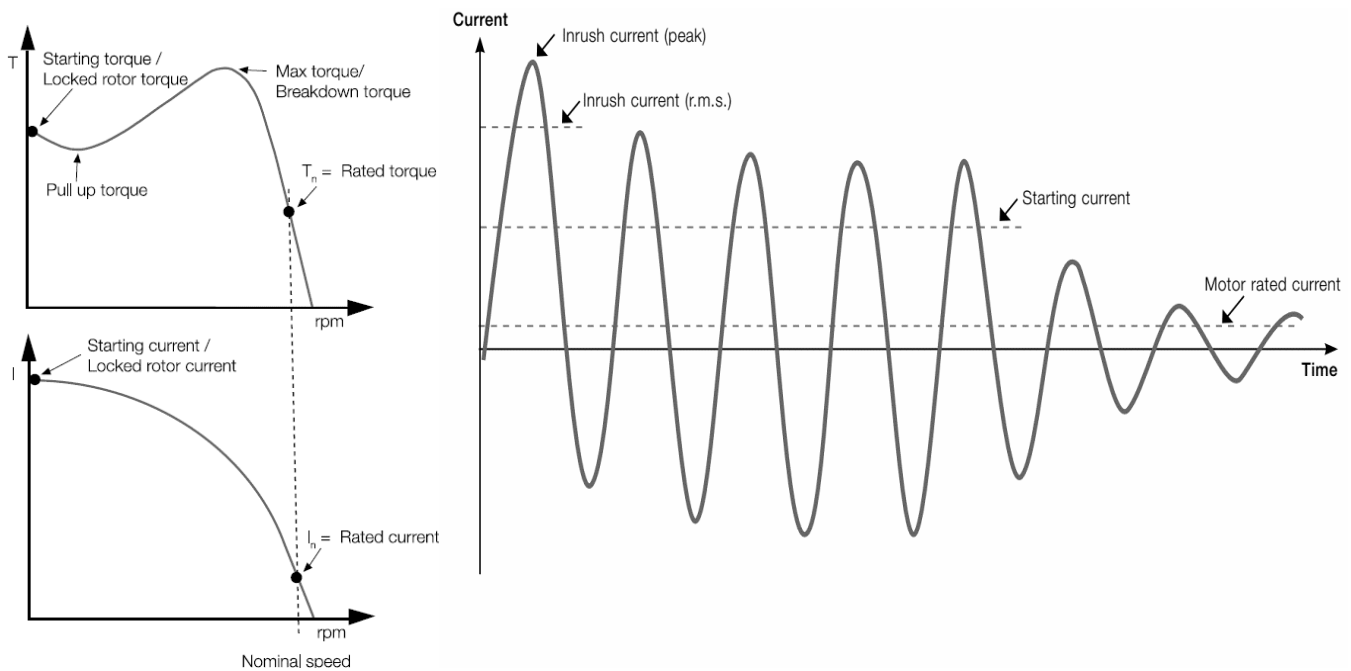

Figure 12: Diagrams of the different currents at the start-up of a motor.

### 3.2.1 About motors

Modern electrical motors are available in many different forms, such as single-phase motors, three-phase motors, brake motors, synchronous motors, asynchronous motors, special customized motors, two speed motors, three speed motors, and so on, all with their own performance and characteristics. For each type of motor there are various mounting arrangements, for example foot mounting, flange mounting or combined foot and flange mounting.

The cooling method can also differ, from the simplest motor with free air self-circulation to a more complex motor with totally enclosed air-water cooling with an interchangeable cassette type of cooler.

To ensure a long life for the motor it is important to select it with the correct degree of protection when operating under heavy-duty conditions in a severe environment.

The two letters IP (International Protection) state the degree of protection followed by two digits, the first of which indicates the degree of protection against contact and penetration of solid objects, whereas the second states the motor's degree of protection against water.

The end of the motor is defined in the IEC-standard as follows:

- The D-end is normally the drive end of the motor
- The N-end is normally the non-drive end of the motor

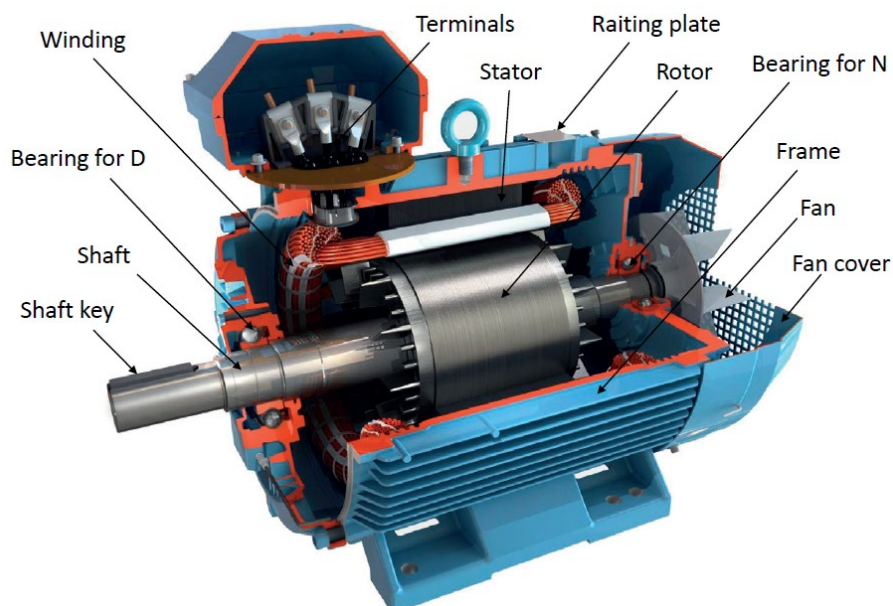

Figure 13: Inside a motor with all the main components.

### 3.2.2 Squirrel cage motors

The squirrel cage motor is the most common type of motor on the market. It is relatively cheap, and the maintenance costs are usually low. There are many different manufacturers represented on the market, selling at various prices. Not all motors have the same performance and quality as, for example, motors from ABB.

The starting current is a characteristic of the motor. The starting time is a function of load torque, inertia and motor torque and is influenced by the motor technology. As the starting current ( $6-13 \times I_e$ ) is always a lot higher than the rated operational current  $I_e$ , an excessively long starting or braking period will cause an overload (temperature rise) in the motor. This could lead to electromechanical stress or damage the motor's isolation.

The lifetime of an electrical engine is linked to the temperature stress. As a rough guide, the lifetime of the winding isolation is reduced by half each time the temperature exceeds  $10^\circ\text{C}$ . Even slight temperature increases can reduce the life time of an electrical engine significantly.

### 3.2.3 International motor efficiency standards and regulations

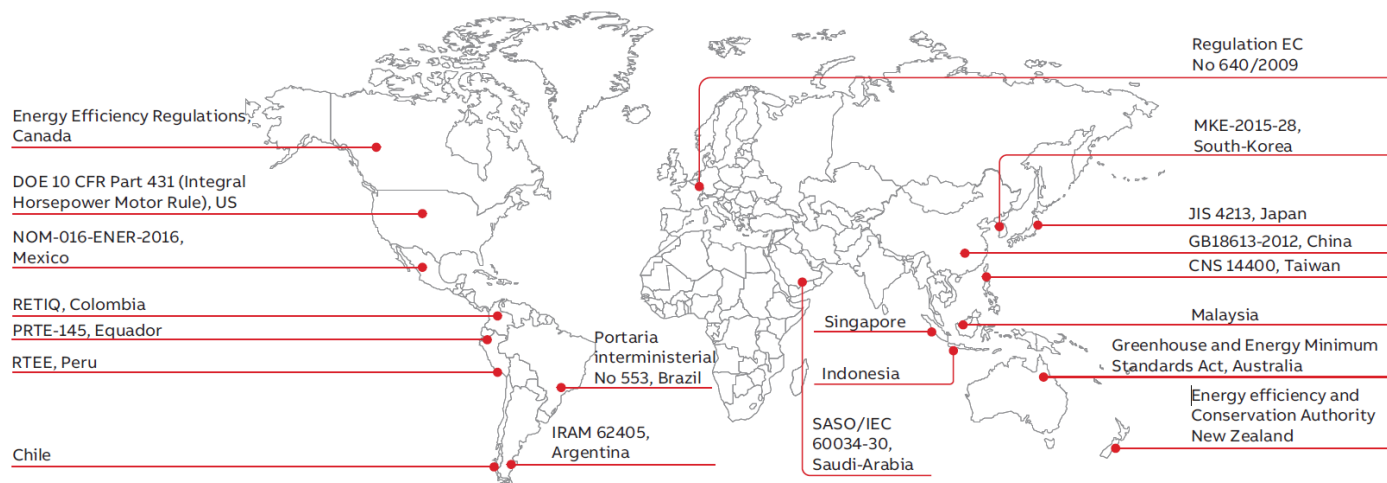

Figure 14: International motor efficiency standards and regulations.

Since the validation of IEC 60034-30:2008 and its refined version IEC 60034-30-1:2014, a worldwide energy efficiency classification system has existed for low voltage three-phase asynchronous motors. These international standards have been created to enable and increase the level of harmonization in efficiency regulations around the world and to also cover motors for explosive atmospheres.

IEC 60034-30-1:2014 defines International Efficiency (IE) classes for single speed, three-phase, 50 Hz and 60 Hz induction motors. The efficiency levels defined in IEC 60034-30-1 are based on the test method specified in IEC 60034-2-1:2014. Both standards are part of an effort to unify motor testing procedures with CSA390-10 and IEEE 112 standards as well as efficiency and product labeling (IE) requirements to enable motor purchasers worldwide to easily recognize premium efficiency products.

To promote transparency in the market, IEC 60034-30-1 states that both the efficiency class and efficiency value must be shown on the motor rating plate and in the product documentation. The documentation must clearly indicate the efficiency testing method used as different methods can produce differing results.

#### 3.2.3.1 Minimum energy performance standards

While the IEC as an international standardization organization sets guidelines for motor testing and efficiency classes, the organization does not regulate efficiency levels in countries. The biggest drivers for mandatory Minimum Energy Performance Standard (MEPS) levels for electric motors are global climate change, government targets to curb CO<sub>2</sub> emissions and rising electricity demand, especially in developing countries. The entire value chain, from the manufacturer to the end user, must be aware of the legislation in order to meet local requirements, to save energy and reduce the carbon footprint.

Harmonized global standards and the increasing adoption of MEPS around the world are good news for all of us. However, it is important to remember that harmonization is an ongoing process. Even though MEPS are already in effect in several regions and countries, they are evolving and differ in terms of scope and requirements. At the same time, more countries are planning to adopt their own MEPS regulations. A view of existing and coming MEPS regulations in the world can be seen on the world map above.



### 3.2.3.2 IEC 60034-30-1:2014

This standard defines four International Efficiency (IE) classes for single speed electric motors that are rated according to IEC 60034-1 or IEC 60079-0 (explosive atmospheres) and designed for operation on sinusoidal voltage.

- IE4 = Super premium efficiency
- IE3 = Premium efficiency
- IE2 = High efficiency
- IE1 = Standard efficiency

#### New N/H and NE/HE motor design categories

IE3/IE4 motors are now defined per IEC 60034-12:2016 standards with the following design types:

- Design N      Normal starting torque with a normal locked rotor current
- Design H      High starting torque with a normal locked rotor current
- Design NE     Normal starting torque with a higher locked rotor current
- Design HE     High starting torque with a higher locked rotor current.

IEC 60034-30-1 covers the power range from 0.12 kW up to 1000 kW. Most of the different technical constructions of electric motors are covered as long as they are rated for direct on-line operation. The coverage of the standard includes:

- Single speed electric motors (single and three-phase), 50 and 60 Hz
- 2, 4, 6 and 8 poles
- Rated output  $P_N$  from 0.12 kW to 1000 kW
- Rated voltage  $U_N$  above 50 V AC up to 1 kV
- Motors capable of continuous operation at their rated power with a temperature rise within the specified insulation temperature class
- Motors, marked with any ambient temperature within the range of -20 °C to +60 °C
- Motors, marked with an altitude up to 4000 m above sea level

By comparing IEC 60034-30-1 to CSA C390-10:2015 and “10CFR431 Subpart B – Electric motors”, it can be seen that the efficiency limits and tables are well aligned, and their major difference is in the scope of the output power where CSA and 10CFR431 have a maximum power of 500 hp. There are some minor differences in the scope of excluded motors.

**3.2.3.3 The following motors are excluded from IEC 60034-30-1:**

- Single-speed motors with 10 or more poles or multi-speed motors
- Motors completely integrated into a machine (for example pumps, fans or compressors) that cannot be tested separately from the machine
- Brake motors, when the brake cannot be dismantled or separately fed

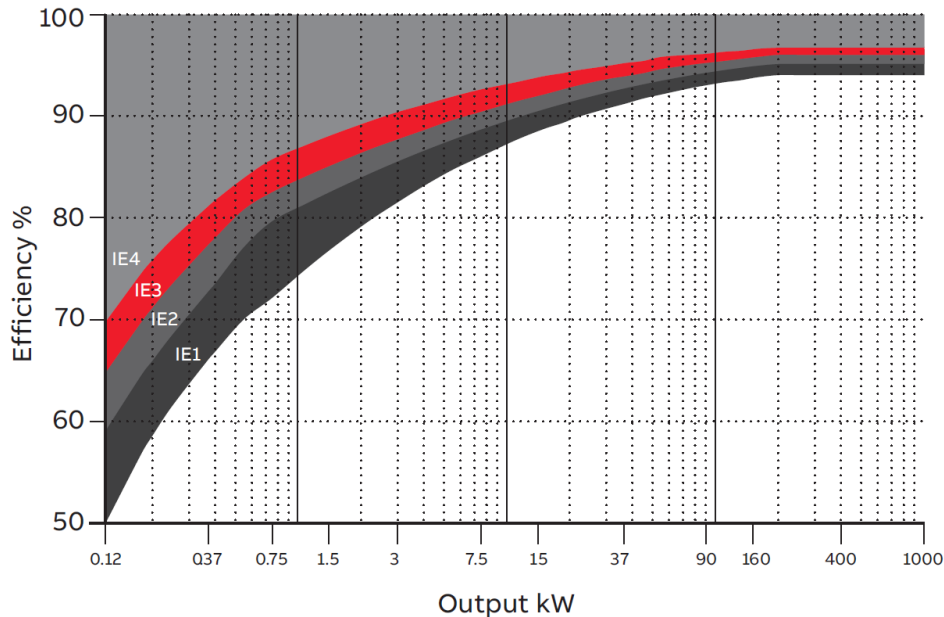

Figure 15: Overview of the nominal efficiency limits defined in IEC 60034-30-1. Note: you will find a detailed overview of the nominal efficiency limits defined in IEC 60034-30-1 in the Appendix.

**3.2.3.4 Motor utilization categories use according to IEC 60947-4-1**

IEC 60947-4-1 Ed.4 introduces now a new AC-3e utilization category for AC current switching and keeps the use and definition of existing AC-3 utilization category unchanged.

<b>Squirrel-cage motors starting, switching off motors during running, reversing</b>	
<b>AC-3</b>	<b>AC-3e</b>
Refer to the <b>asynchronous motor of designs N and H</b> according to IEC 60034-12:2016	Refer to the <b>asynchronous motor of designs NE and HE</b> , according to IEC 60034-12:2016, with extended / higher locked rotor apparent power and current than design N and H respectively, to achieve a higher efficiency class according to IEC 60034-30-1.
<b>AC-3 Making and breaking capacities unchanged</b>	<b>New AC-3e Making and breaking capacities</b>
Rated making capacity: 10 x I <sub>e</sub> AC-3 Rated breaking capacity: 8 x I <sub>e</sub> AC-3	Rated making capacity: 13 x I <sub>e</sub> AC-3e Rated breaking capacity: 8.5 x I <sub>e</sub> AC-3e

Table 11: These categories may be used for occasional inching (jogging) or plugging for limited time periods such as during machine set-up; during such limited time periods, the number of such operations should not exceed five per minute or more than ten in a 10-min period.

### **3.2.3.4 ABB and efficiency standards**

ABB determines efficiency values according to IEC 60034-2-1 using the low uncertainty method (i.e. summation of losses), with additional load losses determined by the residual loss method.

It is good to mention and emphasize that the IEC 60034-2-1 test method, which is known as an indirect method, is technically equivalent to the test methods in the standards CSA 390-10 and IEEE 112 Method B leads to the equivalent losses and thus efficiency values.

As the world market leader, ABB offers the largest range of LV motors available. It has long advocated the need for efficiency in motors, and high efficiency products have formed the core of its portfolio for many years. The core of ABB's process performance range is based on a full range of IE2 and IE3 motors - with many available from stock. We also supply IE4 motors for additional energy savings.

### **3.2.3.5 Motors for NEMA Premium**

The NEMA Premium® Motors program for the North American market must comply with the EISA 2007 energy efficiency standards. Since December 2010, the engines must be NEMA Premium Efficient. These requirements are similar to the IE3 requirements. The technical requirements for motors for the North American market are described in NEMA MG-1.

### 3.2.3.6 What differs an IE3/IE4 motor from motors with lower efficiency?

IE3 motors are able to achieve higher efficiency thanks to innovative designs and the use of better conducting material. The higher efficiency design will ultimately show a lower rated motor current for any given kW rating. However, during the starting phase of the motor there may be an increase of inrush and starting current. The increased inrush and starting current can in some cases affect the selection of the starter components as well as the short-circuit protection device.

If a motor is directly connected to the line, the current drawn will be very high at the start-up, which is mostly reactive. The line in the following figure shows a typical starting RMS current curve for an IE3 motor in a direct online connection. In general, the motor draws current in three steps:

- Shortly after starting, during the first 20 ms to 30 ms:  $I_{peak}$  a high peak current (inrush).
- Between the inrush and 0.5 s to 10 s (depending on rated power and inertia), a steady-state current  $I_d$ . This current remains constant as long as the rotor starts revolving; its duration depends on the motor's load and design.
- After 0.5 s to 10 s: the rotor accelerates and reaches its final speed. The current stabilizes to reach the motor's rated current  $I_n$  at full load.

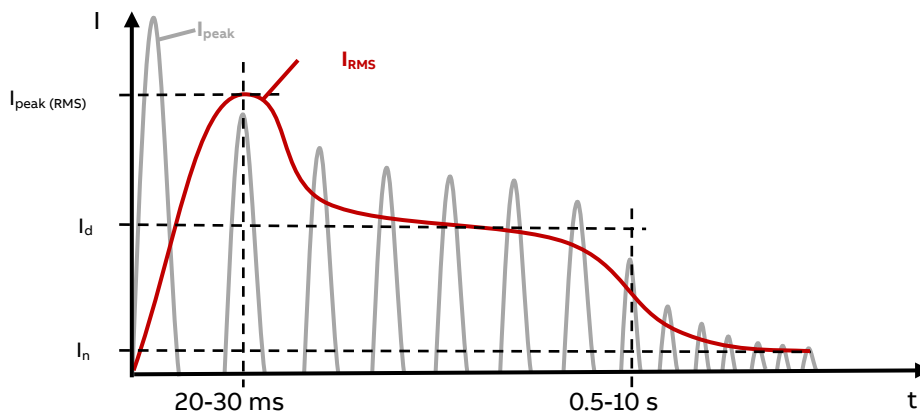

Figure 16: Diagram with the Current at the start of a IE3 motor.

To be able to offer the best possible starter solutions, ABB performed many tests on different motors, to map the relevant data when starting the motors, also taking into consideration the findings of ABB's own motor manufacturing units. The tests and analyses clearly show that premium efficiency motors (IE3 motors) in general will draw a higher starting current than IE1 and IE2 motors. There is an estimated 15 % higher starting current compared to IE2 motors. Once the IE3 motor reaches full speed, the rated motor current is lower for the same load conditions, because of the higher efficiency and the desired energy savings.

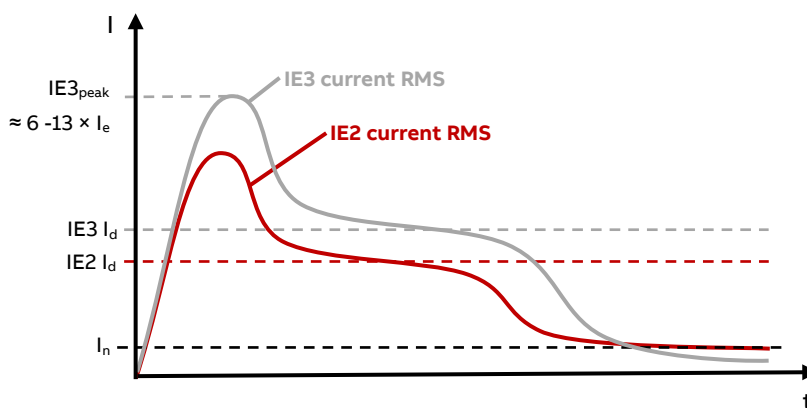

Figure 17: Diagram showing the different currents for the IE3/IE2 motors.

### 3.2.4 Rating plate of a motor

The rating plate details on a motor provide the user with information relating to the construction and performance characteristics of the motor. On the rating plate it is necessary to indicate the IE code and nominal efficiency of the motor at full load 100 %, 3/4 load 75 % and 1/2 load 50 %, as required by IEC 60034-30-1.

Here is an example of a rating plate:

1 CE      2 IE3 3 ~ Motor      4 M3BP 315SMC 4 IMB3/IM1001						
5 2018 No.						
6 Ins.cl. F      7 IP 55						
1 V	2 Hz	3 kW	4 r/min	5 A	6 cos φ	7 Duty
690 Y	50	132	1488	134	0.86	S1
400 D	50	132	1488	231	0.86	S1
415 D	50	132	1489	225	0.85	S1
8 IE3-95.7%(100%)-95.8%(75%)-95.3%(50%)						
9 Prod. code 3GBP312230-ADL						
9 Nmax 2300 r/min						
10 6319/C3      6316/C3      9 1000 kg						
ABB      10 IEC 60034-1						

Figure 18: Rating plate of a ABB motor

**Basic information:**

- 1 - Certification label
- 2 - Efficiency Code – IE
- 3 - Number of phases
- 4 - ABB motor type
- 5 - Manufacturing date
- 6 - Insulation class
- 7 - Degree of protection
- 8 - Product code
- 9 - Motor weight
- 10 - IEC Standard

**In-/output information:**

- 1 - Rated operating voltage
- 2 - Frequency
- 3 - Motor rated power
- 4 - Full load speed
- 5 - Rated operating current
- 6 - Power factor
- 7 - Service factor
- 8 - Partial load efficiencies
- 9 - Rotation speed
- 10 - Drive end bearing type and amount of grease (where applicable) and non-drive end bearing type and amount of grease (where applicable)

### 3.2.5 Voltage

Three-phase single speed motors can normally be connected for two different voltage levels. The three stator windings are connected in star (Y) or delta (D) configurations. If the rating plate on a squirrel cage motor indicates voltages for both the star and delta connections, it is possible to use the motor for both 230 V AC, and 400 V AC as an example.

The winding should be a delta configuration if connected at 230 V AC and if the main voltage is 400 V AC, a star connection is used.

When changing the main voltage, it is important to remember that for the same power rating the rated motor current will change depending on the voltage level. The method for connecting the motor to the terminal blocks for star or delta connection is shown in the picture below.

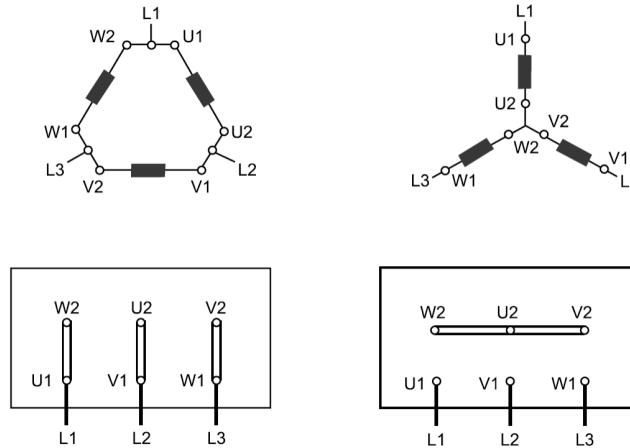

Figure 19: Voltage connection at the motor.

### 3.2.6 Current

The rated current of the motor, which can be found on the motor nameplate, is the current used by the motor when fully loaded and while up in full speed. An unloaded motor will use far less current and an overloaded motor will use more current. During a direct on-line start, the current used by the motor is far higher than the rated current.

This is usually between 6-13 times the rated current (for IE3 motors), but it can be more than 10 times the rated current. This can be clearly seen in a speed-current diagram for the motor. As the motor accelerates the current will drop and when reaching the rated speed, the current will  $\approx 6 - 13 \times I_n$  pped to the rated current.

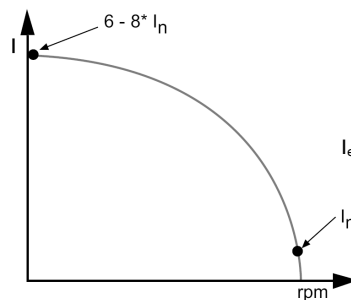

Figure 20: Diagram of the current vs. speed.

The required increase in efficiency of the IE3 motors is usually achieved by lower rated currents of the motors. In the small power ranges, the required increase in efficiency is greater, so that the deviation of the rated current is greater there. The higher the power, the lower the deviation of the rated currents compared to IE1 / IE2 motors.

#### Increasing starting current conditions

The starting current conditions (ratio of the starting current to the rated current, steady state, stalled rotor) increase with an increasing IE class.

### Amplitude of inrush current

The amplitude of the inrush current from IE1 to IE2 and IE3 / IE4 depends on the following factors in the respective application:

- The structure of the motor
- Network conditions (in particular the size of the short-circuit power of the transformer and thus the voltage stability)
- The length and routing of the motor cables
- The switch-on phase position in the respective phase

### 3.2.7 Power factor

A motor always consumes active power, which it converts into mechanical action. Reactive power is also required for the magnetization of the motor, but it does not perform any action. In the diagram below the active and reactive power is represented by P and Q, which together give the apparent power S.

The ratio between the active power P (kW) and the apparent power S (kVA) is known as the power factor, and is often designated as the  $\cos \varphi$ . A normal value is between 0.7 and 0.9. When running, where the lower value is for small or low loaded motors and the higher for large ones.

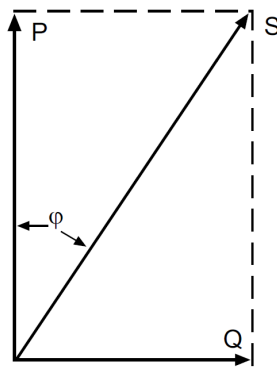

Figure 21: Diagram indicating P, Q, S and  $\cos \varphi$ .

### 3.2.8 Torque

The starting torque for a motor differs significantly depending on the size of the motor. A small motor, e.g.,  $\leq 30$  kW, normally has a value of between 1.5 and 2.5 times the rated torque, and for a medium size motor, say up to 250 kW, a typical value is between 2 to 3 times the rated torque. Very large motors tend to have a low starting torque, sometimes even lower than the rated torque. It is not possible to start such a motor fully loaded, not even a direct online start.

$T_n$  = Rated torque (Nm)

$P_r$  = Rated motor power (kW)

$n_r$  = Rated motor speed (rpm)

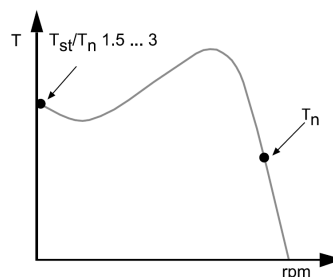

Figure 22: Diagram of the torque vs. speed.

## Different load conditions

All motors are used for starting and running different applications. These applications will result in different load conditions for the motor. This is a direct braking force on the motor shaft. To be able to accelerate, the motor must be stronger than the load. The accelerating torque is the difference between the available motor torque and the load torque. Many starting methods will reduce the torque of the motor and thereby reducing the accelerating torque which will give a longer starting time. The accelerating torque = the available motor torque – the braking load torque. The load curve can have different characteristic depending on the application. Some of the common load types can be seen below.

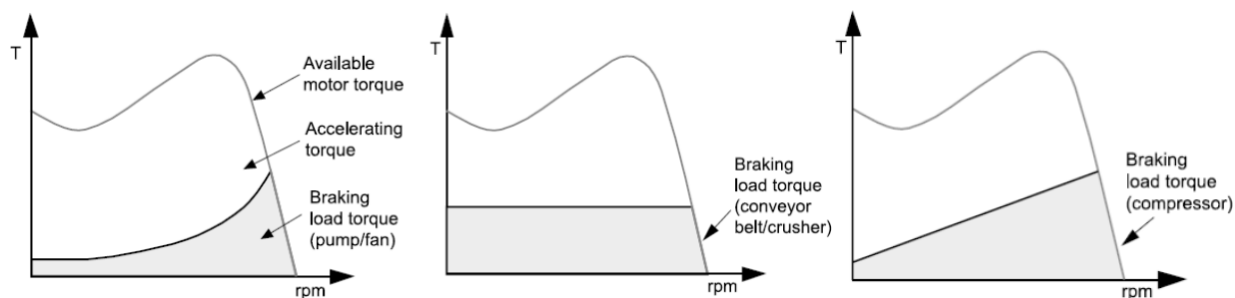

Figure 23: Diagram of the torque vs. speed for different load conditions.

Many applications are started unloaded, and the load is applied first when the motor has reached the rated speed. This will reduce the load torque to about 10-50% of the load torque of a loaded start.

Manual motor starters are well suited for both the control and protection of motors, including high-efficiency types. Since the tests for IEC utilization category AC-3 and UL/CSA “AC Motor” have yet to be fully harmonized, manual motor starters carry both ratings to ensure international acceptability.

For additional information regarding IE3 high-efficiency motors, please click the “Info on IE3 Motors” link in the Selected Optimized Coordination (SOC) selection tool (<http://applications.it.abb.com/SOC/page/selection.aspx>).

## 3.3 Hermetic refrigerant compressor motors

A hermetic refrigerant compressor motor is a combination of a compressor and a motor, both of which are enclosed in the same housing, with no external shaft or shaft seals, with the motor operating in refrigerant. These motors are commonly used in air-conditioning and refrigeration equipment. Two harmonized utilization categories exist for these types of loads: AC-8a and AC-8b. AC-8b is an additional test accompanying AC-8a and is referred to as a “recycle rating”, which covers applications where overload releases are automatically reset. Manual motor starters can be used for manual control and protection of these motors. For control, use AF contactors.



## 3.4 Lamps and lighting loads

Two lamp-specific utilization categories exist: AC-5a for electric discharge (fluorescent) lamps, and AC-5b for incandescent lamps, both of which have been fully harmonized. ABB has special lamp starters that are suitable for the manual control of lamp loads. The table below shows the correlation between these ratings and a variety of commercially available lamps.

Lamp type	Ballast AC-5a	Tungsten AC-5b
Compact fluorescent lamps	X	
Florescent lamps with electronic ballast <sup>1)</sup>	X	
Halogen electric light bulbs		X
Halogen metal vapor lamps	X	
High-pressure discharge lamps	X	
Incandescent (filament) light bulbs		X
LEDs	X	
Mercury vapor high-pressure lamps	X	
Mixed lamps		X
Sodium vapor high-pressure lamps	X	

Table 12: Lamps and lighting loads.

## 3.5 Transformers

A transformer is a passive electrical device designed to change one voltage to another. Therefore the ABB has built a version of Manual motor starters MS132-T, this suitable for control and protection of control transformers.

### 3.5.1 Primary-side protection of transformers

For the primary-side protection of transformers, the inrush current of an open-circuiting transformer must be considered. Here, due to the supersaturation of the iron core, a high magnetizing current, which may be 15 to 20 times the rated transformer current occurs, and typically lasts for a period of up to 40 ms.

The power-on spikes will clear within a few milliseconds, but may trigger the short-circuit release, especially on fast, high-current-limiting circuit-breakers. Slow circuit-breakers are better suited here, especially if the short-circuit release range can be adjusted and set to a higher value, or a direct release via short delay is possible.

Manual motor starters (only the MS132-T and MS132-KT) for transformer protection are electromechanical protection devices specially designed to protect control transformers on the primary side. They allow fuse less protection against overload and short-circuits saving space and cost and ensuring a quick reaction under short-circuit conditions by switching off the transformer within milliseconds. Additionally the devices allow manual connection and disconnection of the transformer from the mains.

### 3.5.2 Secondary-side protection of transformers.

Similarly to motors, transformers are overloadable, depending on the previous continuous power and the coolant temperature. Transformers are less sensitive to short-term overloads such as motors. Although circuit-breakers offer too much protection against thermal overload, they are nevertheless well suited for transformer protection.

For the secondary-side protection of transformers, circuit-breakers are used which have a switching capacity equal to or greater than the transformer short-circuit current. The thermal overload release of the circuit-breaker needs to be set to the rated transformer current.

Short circuit protection is provided by instantaneous electromagnetic releases. For selectivity tasks for the downstream short-circuit protection devices, circuit-breakers with short overcurrent release times need to be provided.

## 3.6 Capacitors

Capacitors are mainly used for reactive energy correction (raising the power factor). When capacitors are energized, overcurrents of high amplitude and high frequencies (3 to 15 kHz) occur during the transient period (1 to 2 ms). For more information regarding the control and protection of capacitors, please contact ABB.

## 4. Environmental and application-specific factors

Manual motor starters are suitable for use in many climates. They are intended for use in enclosed environments in which no severe operating conditions (such as dust, caustic vapors or hazardous gases) prevail. When installed in dusty and damp areas, suitable enclosures must be provided.

### 4.1 Ambient air temperature compensation and derating

Temperature compensation applies to bi-metallic devices which employ a secondary bi-metal to counteract the bi-metals of the inverse time-delay overcurrent release. The secondary bi-metal is not heated by the motor current, instead it reacts only under the influence of the ambient air temperature. As a result, the effects of the ambient temperature in regard to manual motor starter tripping is automatically compensated for.

ABB manual motor starters have an allowable ambient temperature range for single mountings between -25°C to 60°C (50°C for MS116). Correction factors for ambient temperatures up to 70°C and for group mounting are shown below.

Device	Current correction factors for single mounting, or group mounting with spacing $\geq 9$ mm <sup>1)</sup>			Current correction factors for group mounting without spacing		
	40°C	60°C	70°C	40°C	60°C	70°C
MS132-0.16 ... 4.0	1.00	1.00	1.00	1.00	1.00	1.00
MS132-6.3	1.00	1.00	1.00	1.00	1.00	0.79
MS132-10	1.00	1.00	0.80	0.91	0.80	0.70
MS132-12	1.00	1.00	0.91	1.00	0.91	0.83
MS132-16	1.00	1.00	0.81	0.93	0.87	0.81
MS132-20	1.00	1.00	0.90	1.00	0.95	0.85
MS132-25	1.00	1.00	0.92	1.00	0.92	0.80
MS132-32	1.00	1.00	0.90	1.00	0.93	0.78

Table 13: Ambient air temperature compensation and derating. Note: the temperature values between those shown can be linearly interpolated.

## 4.2 Duty cycles and restarting

To avoid issues with nuisance tripping, manual motor starters should not be operated at an arbitrary operating frequency. Applications involving up to 15 starts per hour are acceptable. Higher starting frequencies are acceptable if the duty ratio is lower and the motor's making current does not appreciably exceed six times the full-load current. The diagram below provides guideline values for starts-per-hour as a factor of the duty ratio (ON- vs. OFF-time) and the time required to start the motor  $t_a$ .

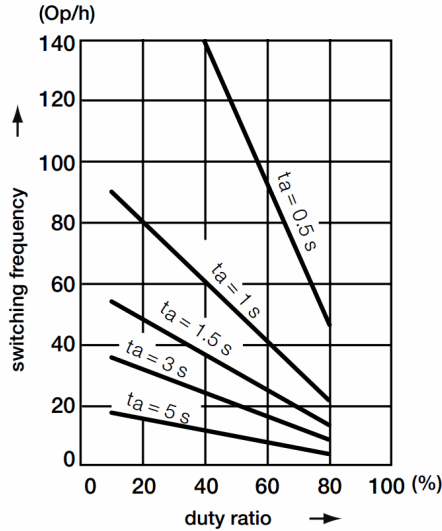

Figure 24: Diagram of the duty cycles and restarting, Example: for a motor with a duty ratio of 60 percent and a start duration of 1 second, 40 starts per hour are acceptable.

After tripping, the bi-metals need to cool down before the manual motor starter can be reset. The device handle will not permit being switched to the ON position until this is achieved.

### 4.3 Frequencies and direct current (DC)

The magnetic trip values for manual motor starters are valid for frequencies from 50 to 60 Hz. Frequencies other than 50/60 Hz will have an impact on the instantaneous short-circuit release. In the range from 45 to 66 Hz, the operating values of the instantaneous short-circuit release are within tolerance. For frequencies above 60 Hz, or for direct current (DC), the operating value of the instantaneous short-circuit release is increased; for frequencies below 50 Hz, the operating value of this magnetic release is decreased. Correction factors for these applications are shown below.

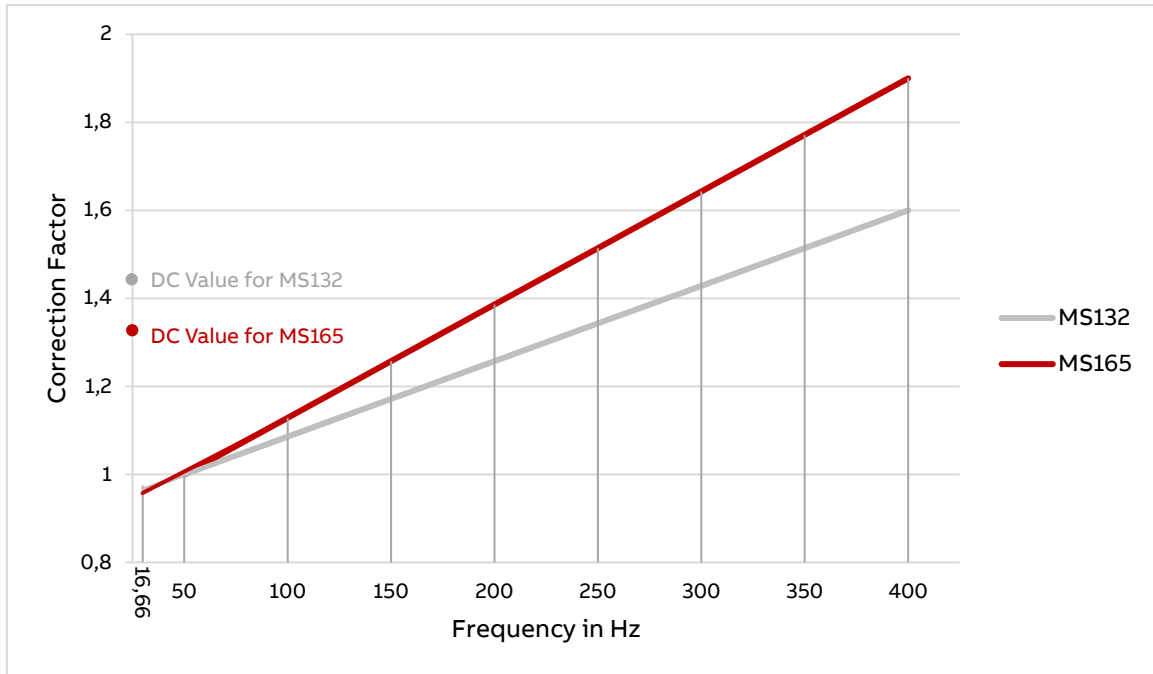

Figure 25: Diagram of different frequencies and direct current (DC).

Thermal tripping characteristics for manual motor starters are valid for DC and AC with frequencies from 16.66 Hz to 400 Hz. For three-pole loads and currents of between 3 - 13 times the set current, the tolerance of the tripping time is  $\pm 20\%$ .

In contrast to alternating current (AC), no current passes take place with direct current (DC). Since current-limiting circuit-breakers do not rely on a current zero crossing to extinguish the arc like contactors, they have hardly any reduced switching capacity in the case of DC short-circuits compared to alternating current.

In the case of a DC short circuit, the current increase in the first phase is quite comparable to that in the case of alternating current (depending on the time constant of the DC circuit). Only the current increase (the steepness of the short-circuit current) is crucial for the opening of the contacts in current-limiting circuit-breakers. As soon as the arc is actively conducted from the blowing field into the quenching chamber and extinguished there, the short circuit is switched off, regardless of when and if a current zero crossing follows.

For symmetrical heating of the thermal overload releases it is also mandatory for circuit-breakers to connect all poles in series (mandatory for differential tripping, analogue thermal overcurrent motor protection relays). The series connection also leads to a faster shutdown.

## 5. Selection criteria

### 5.1 Sizing manual motor starters for motor applications

Manual motor starters should be sized based on the rated current (for UL full-load amps (FLA)) of the motor. The rated operational current  $I_e$  of a manual motor starter represents the maximum current rating of the device. Similarly to thermal overload relays, these devices are provided with a thermal setting range. Manual motor starters should be selected so that the motor current rating falls between these ranges. If the thermal setting ranges of two devices overlap for the intended motor current, select the device with a range that will allow greater flexibility for adjustment. For magnetic only (MO) manual motor starters, select the device with a rated operational current  $I_e$  equal to, or the next size above, the FLA of the motor.

### 5.2 Selected Optimized Coordination (SOC)

As a help to select the right ABB product for the application, the “Selected Optimized Coordination” (SOC) web tool will be very useful.

In order to guarantee the best performance and the longest lifetime, devices involved in the applications mentioned above (short-circuit protection devices, contactors, overload relays, soft starters) need to be coordinated.

The coordination between devices cannot be determined directly: tests in power laboratories have to be carried out to qualify the coordination type at low fault and high fault currents according to IEC or UL standards. ABB coordination tables are the results of such tests and represent the ABB offerings in terms of motor starting and protection, selectivity, back-up and switch-disconnector protection.

In the SOC all available ABB coordination tables are stored and easily accessible. The following chapter will guide you on the main tasks and user interactions.

The SOC is available on [www.abb.com/lowvoltage](http://www.abb.com/lowvoltage) (in the "Support" menu select "Online Product Selection Tools", then select "Coordination Tables") or at the following permanent link: <http://applications.it.abb.com/SOC>.

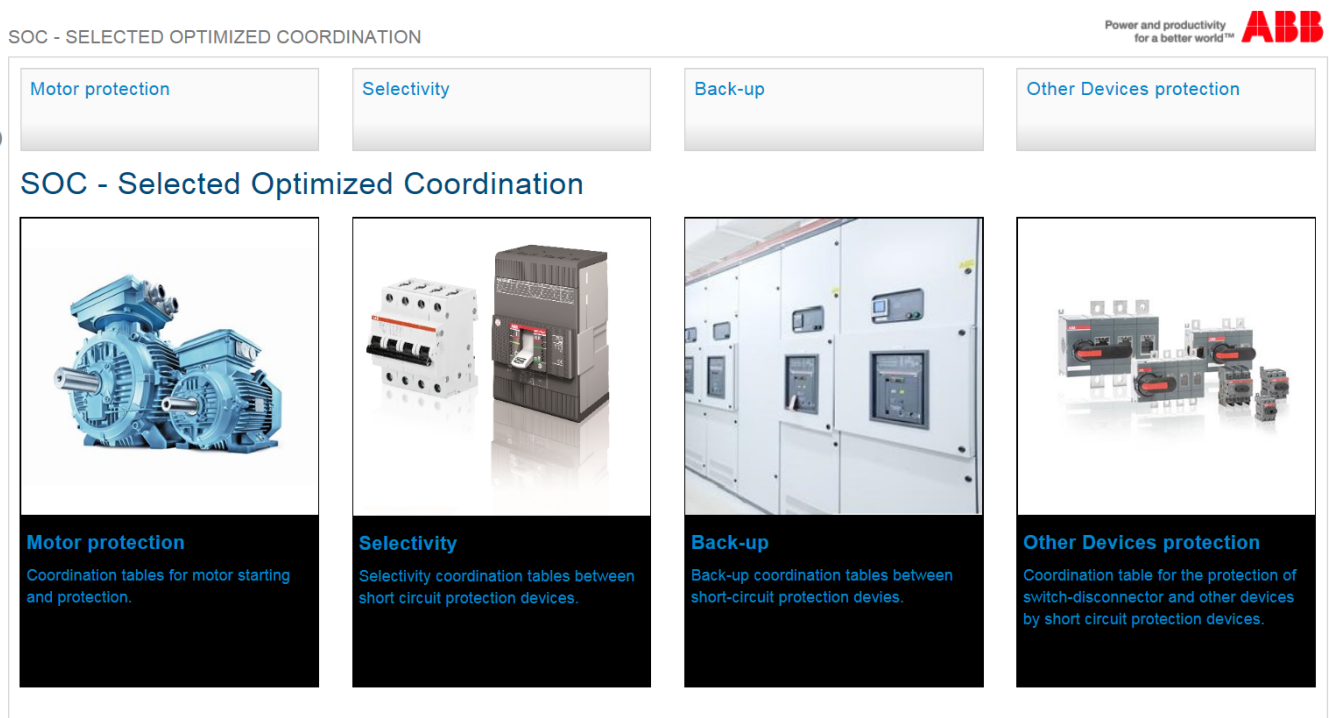

Figure 26: Screenshot from SOC

Under the interface “Motor protection” the following filters are available:

- type of protection device
- rated voltage
- short-circuit current
- starter type
- coordination type
- overload relay
- motor rated power

For example: if you are looking for products for motor protection where a manual motor starter is used as a short-circuit protection device, in a plant where the rated voltage is 400Vac and the IE3 Motor Rated Power is 2.2kW:

SOC - SELECTED OPTIMIZED COORDINATION

Power and productivity for a better world™ **ABB**

Coordination tables for Motor protection

→ Info on IE3 Motors → UL Motor Coordinations BETA

Standard:  IEC  UL Motor efficiency class:  ANY  IE1/IE2  IE3

Motor Rated Power [kW]	Rated voltage	Short-Circuit Current [kA]	Starter Type	Coordination type	Protection device	Overload relay
0.18	230Vac	16	DOL-NS	IEC Type 1	Fuses	Embedded
0.25	400Vac	25	DOL-HD	IEC Type 2	MCCB	TOL
0.37	415Vac	30	SD-NS		MMS	EOL
0.55	440Vac	35	SS-NS-IL			UMC
0.75	500Vac	50				
1.1	525Vac	65				
1.5	690Vac	70				
2.2		80				
3		100				
4						

Search Export PDF

Results 56 Internal use only records.  Show newest ABB products only 20 Number of Records to show

Figure 27: Screenshot from a example on SOC

SOC shows the right protection device for the selected application depending on the coordination type. Click on >> to see the complete table

MMS, 400 Vac, 35 kA, DOL-NS, Coordination type : IEC Type 1, Overload relay : Embedded, Motor efficiency class IE1 + IE2 + IE3

Motor		MMS		Contactor		Max allowed load current
Motor Rated Power [kW]	Rated Current (FLA) [A]	Inst. Trip. Current [A]	Current range [A]	Type		[A]
2.2	4.90	78.75	4.00 - 6.30	AF09		6.30

Table >>

Figure 28: Screenshot from a example on SOC

## 6. Installation and commissioning

### 6.1 Mounting

Manual motor starters can be mounted as follows:

- Fixed on a 35 mm top hat rail according to DIN EN 60715 (35 x 15 or 35 x 7.5 mm).
- Mounted using a screw fixing on a wall/panel. Manual motor starters can be fastened to the wall/panel using screws. MS116/MS132 manual motor starters require an additional accessory.

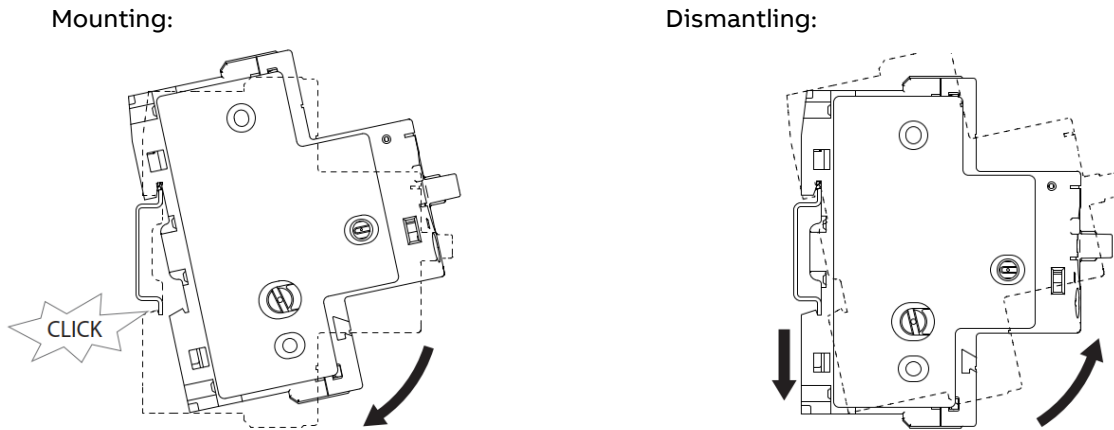

Figure 29: Mounting of a manual motor starter.

#### 6.1.1 Mounting position and minimum distances

When mounting the manual motor starters, keep the following clearances to grounded or live parts and insulated conduit ducts according to IEC 60947-2:

- *Single installation:* there must be no directly attached contactor and there is a minimum gap of 9 mm to the left and to the right.
- *Group installation:* the contactor must be mounted directly or the gap to the left or the right must be less than 9 mm.

##### 6.1.1.1 Mounting position

Mounting positions 1 until 6 are permitted for manual motor starters.

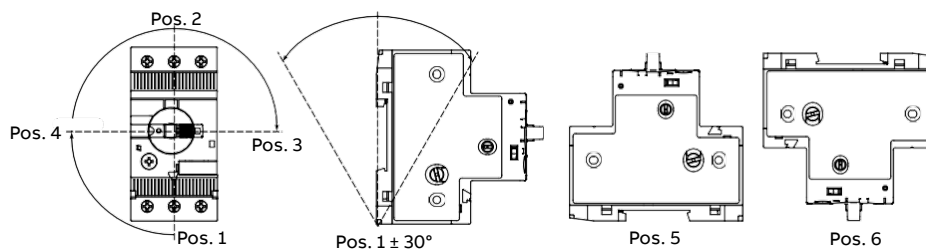

Figure 30: Mounting position of a manual motor starter.



### 6.1.1.2 Minimum distance

The following table shows the minimum distance to other units of the same types and also to an electrically conductive wall (earthed).

		MS116	MS132	MS165
Minimum distance to other units of the same type [mm]	Horizontal	0	0	0
	Vertical	150	150	150
Minimum distance to electrically conductive wall (earthed) [mm]	Horizontal - up to 400 V AC	0	0	0
	Horizontal - up to 690 V AC	>1.5	>1.5	>1.5
	Vertical	75	75	75

Table 14: Minimum distance by mounting.

## 6.2 Connection

The manual motor starter can be supplied either from the bottom or from the top (for non-UL applications).

### 6.2.1 Connection Types

The manual motor starter is available with the following types of connection:

- Screw terminals
- Push-in Spring terminals







Push-in Spring terminals allow conductors to be easily connected directly. The special contact spring allows easy insertion and guarantees a good contact quality.

### 6.2.2 Connection cross sections







#### 6.2.2.1 Connection cross sections for screw connection technology

The following tables show the permissible conductor cross-sections for the main connections and auxiliary conductor connections for sizes MS116, MS132, MO132, MS165 und MO165.

##### For MS116:

							
MS116 ≤ 16 A	M3.5 0.8 ... 1.2 Nm / 10 ... 12 lb.in	ø 5.5 mm	Pozidriv No. 2	1/2 x 1 ... 4 mm <sup>2</sup>	1/2 x 0.75 ... 2.5 mm <sup>2</sup> 1/2 x AWG 16 ... 12	1/2 x 0.75 ... 2.5 mm <sup>2</sup>	9 mm
MS116 ≥ 16 A	M4 2 Nm / 18 lb.in	ø 6.5 mm		1/2 x (1...2.5) (2.5...6) mm <sup>2</sup>	1/2 x (1...2.5) (2.5...6) mm <sup>2</sup> 1/2 x AWG 16...8	1/2 x 0.75...6 mm <sup>2</sup>	10 mm

##### For MS132 and MO132:

							
MS132 ≤ 10 A MO132 ≤ 10 A	M3.5 0.8 ... 1.2 Nm / 10 ... 12 lb.in	ø 5.5 mm	Pozidriv No. 2	1/2 x 1 ... 4 mm <sup>2</sup>	1/2 x 0.75 ... 2.5 mm <sup>2</sup> 1/2 x AWG 16 ... 12	1/2 x 0.75 ... 2.5 mm <sup>2</sup>	9 mm
MS132 ≥ 16 A MO132 ≥ 16 A	M4 2 Nm / 18 lb.in	ø 6.5 mm		1/2 x (1...2.5) (2.5...6) mm <sup>2</sup>	1/2 x (1...2.5) (2.5...6) mm <sup>2</sup> 1/2 x AWG 16...8	1/2 x 0.75...6 mm <sup>2</sup>	10 mm

##### For MS165 am MO165:







							
MS165 MO165	M6 4 Nm / 10 ... 12 lb.in	ø 6.5 mm	Pozidriv No. 2	1/2 x 1 ... 50 mm <sup>2</sup> 1/2 x AWG 16...0	1/2 x 1 ... 35 mm <sup>2</sup> 1/2 x AWG 16...0	1/2 x 1...35 mm <sup>2</sup>	16 mm

Table 15: Connection cross sections for screw connection technology for manual motor starters.

**For accessories:**













							
<b>SK1, HK1, HKF1</b>	M3.5 0.8 ... 1.2 Nm / 7 lb.in	ø 5.5 mm		1/2 x 1 ... 1.5 mm <sup>2</sup>	1/2 x 0.75...1.5 mm <sup>2</sup> 1/2 x AWG 16...14	1/2 x 0.75...1.5 mm <sup>2</sup>	
<b>UA1, AA1</b>	M3.5 0.8 ... 1.2 Nm / 7 lb.in	ø 5.5 mm	Pozidriv No. 2	1/2 x 1...4 mm <sup>2</sup>	1/2 x 0.75...2.5 mm <sup>2</sup> 1/2 x AWG 16...14	1/2 x 0.75...2.5 mm <sup>2</sup>	8 mm
<b>S1-Mx-25</b>	M3.5 2.5 Nm / 22 lb.in	ø 5.5 mm		1 x 6...25 mm <sup>2</sup> 1x AWG 10...4	1 x 6...25 mm <sup>2</sup> 1x AWG 10...6		10 mm
<b>S1-Mx-35</b>	M8 4.5 Nm / 40 lb.in		Hexa- gon 4	1 x 100...35 mm <sup>2</sup> 1x AWG 8...2	1 x 100...35 mm <sup>2</sup> 1x AWG 8...2		12 mm

Table 16: Connection cross sections for screw connection technology for accessories.

**6.2.2.2 Connection cross sections for push-in spring terminal technology**

The following tables show the permissible conductor cross-sections for main connections and auxiliary conductor connections of the MS132K manual motor starter:

**MS132-K:**

						
<b>MS132-K (Push-in)</b>		1 ... 2.5 mm <sup>2</sup>	1 ... 6 mm <sup>2</sup> AWG 10 ... 8	1 ... 4 mm <sup>2</sup>	1x 1 ... 4 mm <sup>2</sup> 2x 1 ... 2.5 mm <sup>2</sup>	12 mm
<b>MS132 -K (Spring)</b>	ø 3 mm x 0.5 mm	1 ... 2.5 mm <sup>2</sup>	0.5 ... 4 mm <sup>2</sup>	1/2 x 0.5 ... 4 mm <sup>2</sup>	1x 0.5 ... 4 mm <sup>2</sup> 2x 0.5 ... 2.5 mm <sup>2</sup>	12 mm

**For accessories:**







						
<b>SK1, HK1, HKF1 (Push-in)</b>		1 ... 2.5 mm <sup>2</sup>	1 ... 2.5 mm <sup>2</sup> AWG 14	1 ... 2.5 mm <sup>2</sup>	1 ... 1.5 mm <sup>2</sup>	10 mm
<b>SK1, HK1, HKF1 (Spring)</b>	ø 3 mm x 0.5 mm	1 ... 2.5 mm <sup>2</sup>	1 ... 2.5 mm <sup>2</sup> AWG 20 ... 14	0.5 ... 2.5 mm <sup>2</sup>	0.5 ... 1.5 mm <sup>2</sup>	10 mm

Table 17: Connection cross sections for push-in spring terminal technology.

## 6.3 Motor current setting procedure

Set the current on the scale of the manual motor starter current setting with the help of a screw-driver. Use a screw-driver on the circuit-breaker scale to set the rated current (setting current)  $I_e$ .

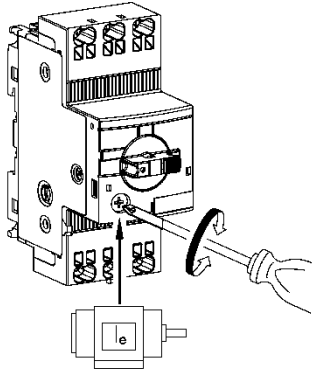

Figure 31: Motor current setting.

## 6.4 Overload trip test

The following figure show the procedures for testing the overload tripping of manual motor starter:

1. Insert a slot screwdriver (e.g. 0.5 x 2.5 mm) into the test opening and gently push it backwards.
2. *Result* - when the manual motor starter trips to “TRIP” the test has been passed (the MS116 trip from “I” to “O”).

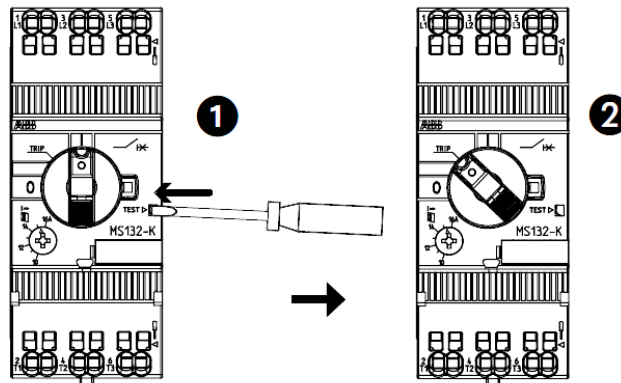

Figure 32: Overload trip test

## 6.5 Restart after tripping

When the manual motor starter trips, the rotary switch goes to the TRIP position to indicate tripping. The tripping of the manual motor starter can optionally be signaled (using an accessory). This can also be done electrically with a signaling switch.

Restarting (after correcting the cause of the error / determining correctness) again takes place directly at the switch. The rotary actuator must first be set to “O” before switching it on again in order to set the mechanism back to standby. Then it cannot be turned on.

## 6.6 How to lock a manual starter by disconnecting

Manual motor starters can be locked so they cannot be switched on without authorization because of repair work, for example. Turn the rotary switch to the OFF position. Pull the cylinder out of the rotary lever. As a result, the rotary drive is locked. Secure the circuit-breaker against unauthorized use by locking the rotary switch with a padlock (bracket diameter 2.5 to 4.5 mm). For the MS116 a special accessory is needed to look the switch, the SA3.

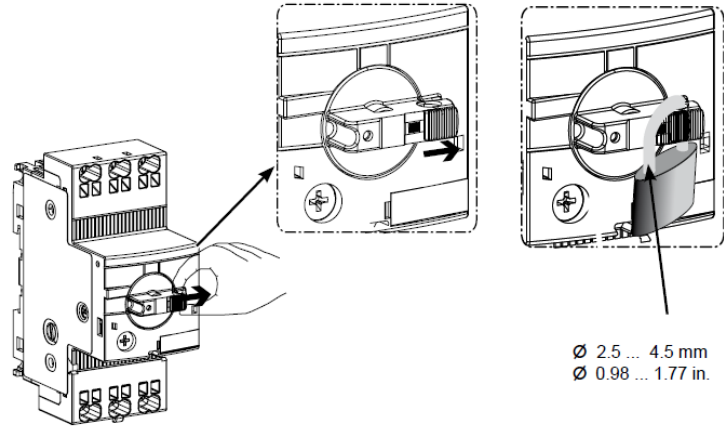

Figure 33: How to lock a manual starter by disconnecting it.

## 6.7 Installation instructions

Installation instructions for manual motor starters can be accessed from the ABB Download Center <https://library.abb.com>. All Categories > Products > Low Voltage Products and Systems > Control Product > Manual Motor Starters.

## 6.8 2D drawings and 3D models

2D and 3D drawings for manual motor starters and accessories can be accessed from the ABB CAD download portal (<http://abb-control-products.partcommunity.com/portal/portal/abb-control-products>).

## 7. Requirements for North America

Electrical machines or electrical plants in the US must be reviewed before being commissioned by an inspector from the relevant AHJ (Authority Having Jurisdiction). Basis for the decrease are the NEC (National Electrical Code, also called NFPA 70), the respective application-specific guidelines, such as The NFPA 79, as well as local standards or specifications.

Operators who do not have their machines or equipment AHJ checked risk losing their insurance protection and damaging the energy supply. For successful on-site inspections, it is important to carry out the project planning according to the required regulations.

### 7.1 General certification in North America

For electrical products to be legally installed in the United States, the Occupational Safety and Health Administration (OSHA) lawfully require these devices to be certified through a Nationally Recognized Test Laboratory (NRTL). An NRTL holds the responsibility for properly certifying manufactures' products to the appropriate product safety standards. The OSHA currently recognizes 15 organizations as NRTLs, most notably including:

- Underwriters Laboratories, Inc.
- Canadian Standards Association
- Intertek Testing Services NA, Inc.

Each product certified by an NRTL is given a unique certification mark to indicate conformity, which becomes a clear sign to inspectors that the product can be legally and safely accepted.

Accreditation in Canada is performed by the Standards Council of Canada (SCC).

#### 7.1.1 Product certification marks

Each NRTL product mark is unique, and differs depending on whether the product has been certified for use in North America, Canada, or both. This is typically indicated by the inclusion of the letters "C" or "US" in the mark. Below are several examples.













Nationally Recognized Test Laboratory	Certified for use in the United States		Certified for use in Canada		Certified for use in both the U.S. and Canada	
	Listed	Recognized	Listed	Recognized	Listed	Recognized
Underwriters Laboratories, Inc.						
Canadian Standards Association						

Table 18: Product certification marks

Products are marked to differentiate between whether they are "Listed" devices, indicating that they meet all of the requirements outlined in the respective product standards, or "Recognized" devices, which meet only some of the requirements of their standard. Recognized components are subject to additional "Conditions of Acceptability" which can be somewhat limiting in regard to their use in electrical installations.

ABB manual motor starters are Listed products bearing a cULus mark.

## 7.1.2 Joint U.S.-Canadian approvals

The Memorandum of Understanding (MOU), signed between UL and CSA in 2003, affords manufacturers the ability to certify products for both the U.S. and Canada through a single organization. This reduces the time to bring products to the market and allows the most state-of-the-art products to start benefiting customers more quickly. The MOU covers the mutual acceptance of components certified by either organization for use in electrical end-product equipment (e.g. Industrial Control Panels).

For more information regarding the MOU, please follow the links shown below.

(<http://ul.com/newsroom/pressreleases/expansion-of-ul-csa/>).

(<http://www.csagroup.org/ca/en/services/testing-and-certification/agreement-on-acceptance-of-components>).

## 7.1.3 Relevant North American standards

The question is which standard needs to be used in which application. When should the UL 508A, NFPA 79 or both be used? In most cases the requirements and interfaces should be clearly regulated by both standards. The overlap requirement is generally the norm. Below is an overview of the North American standards referenced in this document.

<b>General installation standards</b>	
— Govern the installation of electrical components and conductors in each country	NFPA® 70 National Electrical Code® (NEC) United States
— Scopes include all electrical installations beyond the point of the utility service drop	CSA C22.1 Canadian Electrical Code (CEC) Canada
— Applicable for residential, commercial, and industrial structures	NOM-001-SEDE-2012 Instalaciones Eléctricas (utilización) Mexico
— Often adopted into law by local governments	
<b>Application-specific standards</b>	
— Govern specific applications (e.g. industrial control panels)	NFPA® 79 – Industrial Machinery UL 508A – Industrial Control Panels
— Can allow for greater flexibility when designing and building electrical equipment	CSA C22.2 No.14 – Industrial Control Equipment
<b>Product standards</b>	
— Govern the products themselves	<b>UL 60947-4-1 – Electromechanical Contactors and Motor-Starters</b> UL 508 – Industrial Control Equipment
— Quantify the necessary product construction, marking and tests required for certification	UL 508A – Industrial Control Panels UL 508C – Power Conversion Equipment UL 489 – Molded-Case Circuit-breakers, Molded-Case Switches, and C.B. Enclosures UL 98 – Enclosed and Dead-Front Switches UL 1077 – Supplementary Protectors for Use in Electrical Equipment UL 248-1 – Low-Voltage Fuses <b>CSA C22.2 No.60947-4-1 – Electromechanical Contactors and Motor-Starters</b> CSA C22.2 No.14 – Industrial Control Equipment CSA C22.2 No.274 – Adjustable Speed Drives CSA C22.2 No.5 – Overcurrent Protection CSA C22.2 No.4 – Enclosed and Dead-Front Switches CSA C22.2 No.235 – Supplementary Protectors CSA C22.2 No.248 – Low-Voltage Fuses

Table 19: Relevant North American standards.

### 7.1.4 Global harmonization efforts

As globalization continues to impact consumers more and more each year, it is becoming increasingly important for customers to understand the rules and regulations of multiple world regions. In an effort to limit the scope of knowledge required to achieve this without sacrificing safety, standards development organizations, including Underwriters Laboratories (UL), the Canadian Standards Association (CSA), and the International Electrotechnical Commission (IEC) are working together. They are combining best practices, eliminating antiquated verbiage, and producing harmonized global standards.

Most notably for the purpose of this document, these organizations have adopted the IEC 60947-4-1 standard to harmonize the UL 60947-4-1 and CSA C22.2 No. 60947-4-1 standards for Electromechanical Contactors and Motor-Starters, which now govern the certification of manual motor starters, replacing UL 508 and CSA C22.2 No.14.

### 7.1.5 Categorizing manual motor starters

Products certified through UL are categorized according to their intended use. This categorization is part of a hierarchical structure of 4-digit codes, referred to as Category Codes (7.1.5 Categorizing manual motor starters). In addition to providing a means for categorization, CCNs also provide installers with clear directions regarding how to properly apply the devices. This is important to consider, as although two products may appear physically similar, their suitable uses may differ drastically. To help avoid issues in regards to proper application, the Online Certification Directory available on the UL’s website provides customers with a means of searching for certified components (<http://ul.com/database>).

Manual motor starters belong to two separate CCNs:

Manual Motor Controllers NLRV		Dual categories	Combination Motor Controllers NKJH	
<b>NLRV</b>	Listed Manual Motor Controllers certified according to UL 60947-4-1 (UL 508) for use in the United States		Listed Combination Motor Controllers certified according to UL 60947-4-1 (UL 508) for use in the United States	<b>NKJH</b>
<b>NLRV7</b>	Listed Manual Motor Controllers certified according to CSA C22.2 No. 60947-4-1 (CSA 22.2 No.14) for use in Canada		Listed Combination Motor Controllers certified according to CSA C22.2 No. 60947-4-1 (CSA 22.2 No.14) for use in Canada	<b>NKJH7</b>

Table 20: Categorizing manual motor starters

Naturally, any attempt to categorize the vast array of products and technologies available for electrical applications can create drawbacks. Most notably, CCNs are intentionally broad, and are often unable to differentiate between similar products technically. For this reason, manual motor starters tested and classified under CCN Manual Motor Controllers (NLRV) occupy the same category as other manual controllers, such as non-fusible disconnect switches, meaning that the inclusion of protective releases, such as thermal and magnetic trip mechanisms, is often understated or completely overlooked.

In an effort to credit their ability to protect circuits in addition to loads, manual motor starters can be tested and classified under an additional product CCN – Combination Motor Controllers (NKJH). This also means that the suitable applications for manual motor starters are split between the two categories. The simplest explanation of the division of applications can be viewed as:

Applications requiring an upstream branch circuit protective device (fuses or 489/No.5 circuit-breaker)	Applications requiring no additional branch circuit protection
Manual Motor Controllers (NLRV)	Combination Motor Controllers (NKJH)
<ul style="list-style-type: none"> <li>— Single motor disconnect</li> <li>— Group installations</li> <li>— Tap conductor protection in group installations</li> </ul>	<ul style="list-style-type: none"> <li>— Manual self-protected Type E</li> <li>— Type F</li> <li>— Protection of ABB Micro drives</li> </ul>

Table 21: Applications requiring

**7.1.5.1 Tap conductor definition from section 240.2 of the National Electrical Code (NEC), 2014 edition**

“A conductor, other than a service conductor, that has overcurrent protection ahead of its point of supply that exceeds the value permitted for similar conductors that are protected as described elsewhere in 240.4.”

A Tap conductor is defined in the NEC 2014 edition electrical code tap rules. The NEC article dealing with overcurrent protection of feeder taps is article 240.21(B). These rules are often referred to as the NEC “tap rules”.

There are five tap rules related to feeder circuit taps:

- Taps not over 3 m (10 ft.) long
- Taps not over 7.5 m (25 ft.) long
- Taps supplying a transformer [primary plus secondary not over 7.5 m (25 ft.) long]
- Taps over 7.5 m (25 ft.) long
- Outside taps of unlimited length



### 7.1.6 Selecting the right Short Circuit Current Ratings (SCCR) level for your UL application

With so many different applications and ratings available for manual motor starters, it can sometimes be difficult to know which SCCR to select. Below is some general advice to assist in the selection. Additionally, an “SCCR reference” is shown next to each application diagram in the previous section. This reference correlates to a UL/CSA maximum short-circuit current rating table column header. These tables can be found in our Main Catalog for Motor Protection and Control which can be accessed in the Download Center (<https://library.abb.com>) All Categories > Products > Low Voltage Products and Systems > Control Product > Manual Motor Starters.

Type	Manual Motor Controllers		for motor disconnect		for group installations		for tap conductor protection in group installations		Manual self-protected Combination Motor Controllers (Type E) <sup>2</sup>	
	Branch circuit protection, max. size per NEC / CEC <sup>1</sup>		480 V	600 V	480 V	600 V	480 V	600 V	480Y / 277 V	600Y / 374 V
	Fuses	Circuit breaker								
A		A	kA	kA	kA	kA	kA	kA	kA	kA

Figure 34: Screenshot from the catalog of the UL/CSA maximum short-circuit current rating table.

If the secondary winding style of the upstream facility transformer is known to be wye, or for delta networks 347 V AC and below, consider first the application of manual motor starters as combination motor controllers. For manual control, select from the “Type E” SCCR. For remote control, select from “Type F”, and ensure that any minimum component size requirements are respected.

For delta networks above 347 V AC, consider the addition of an upstream fuse block and fuses. The manual motor starter can serve as the main branch disconnect when marked “Suitable as Motor Disconnect” and positioned on the load-side of the branch circuit protective device. The “Motor disconnect” SCCR should be referenced. These ratings apply whether the upstream BCPD contains fuses or a circuit-breaker unless otherwise noted.

For panels designed to control multiple branch circuits, consider the possibility of a group installation. Most industrial control panels are supplied by a circuit-breaker or set of fuses that could be sized based on the requirements for group installation. In the U.S., when using manual motor starters in group installations for manual control, the “Tap Conductor Protection” SCCR should be referenced. For Canada, or for the U.S. when also combining AF contactors for remote control, select from the “Group installation” SCCR. A 3-phase accessory busbar is available to provide a compact solution for group installation.

If the upstream protective device is too large to protect the group, or if any of the other requirements for group installation cannot be met, manual motor starters should be employed as non-combination starters. They can provide manual control themselves or provide overload protection as part of a magnetic or solid-state starter assembly. Close coupling adaptors are available for AF contactors and PSR softstarters to reduce installation time and panel space. In these applications, the “Motor disconnect” SCCR is referenced. If an additional controller is used (e.g. contactor), use the component-level short-circuit current ratings for these devices.

## 7.2 North American voltage supply networks and load types

Electrical networks in North America supply power to residential, commercial, and industrial structures. Depending on the amount of power required for a given installation, various voltage configurations can be utilized.

### 7.2.1 North American voltages

North American commercial installations are typically supplied using either 120/240 V AC split (dual) or 208Y/120 V AC, 3-phase wye networks. Industrial installations within the U.S. commonly use 480Y/277 V AC, 3-phase wye networks. For Canada, the network voltages are increased to 600Y/347 V AC. However, 3-phase delta networks, which do not offer a line-to-neutral voltage, are also common, most often supplying either 240, 480 or 600 V AC.

Application	Network configuration (excluding ground wire)	Nominal supply voltage (line-to-line)	Nominal supply voltage (line-to-neutral)
Commercial	2-phase, 3-wire	240 V AC 2-phase (split/dual)	120 V AC 1-phase
	3-phase, 4-wire (wye)	208 V AC 3-phase	120 V AC 1-phase
Industrial and large commercial in the United States	3-phase, 3-wire (delta)	240 V AC 3-phase	--
	3-phase, 4-wire (wye)	480 V AC 3-phase	277 V AC 1-phase
	3-phase, 3-wire (delta)	480 V AC 3-phase	--
Industrial and large commercial in Canada	3-phase, 4-wire (wye)	600 V AC 3-phase	347 V AC 1-phase
	3-phase, 3-wire (delta)	600 V AC 3-phase	--

Table 22: North American voltages

Manual motor starters are commonly applied in both industrial and commercial applications. To meet the requirements for North America, they are suitable for use on 1- and 3-phase networks with line-to-line voltages up to 600 V AC.

### 7.2.2 Three-phase network configurations

North American 3-phase supply networks differ based on the secondary winding of the upstream transformer. The two most common secondary winding styles are wye, which includes three power legs and a neutral, and delta, which includes only three power legs without a neutral connection. These networks can be either grounded or ungrounded.

Solidly grounded wye and ungrounded delta networks are most common in North America.

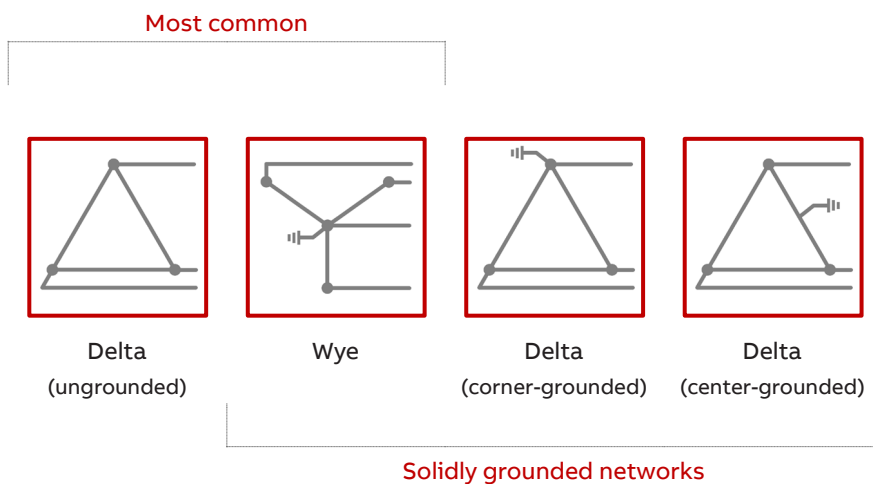

Figure 35: Three-phase network configurations.

## 7.2.3 Straight vs. slash voltage ratings

Short-circuit protective devices with straight voltage ratings (e.g. 480 V AC) can be applied in any circuit, grounded or ungrounded, where the line-to-line voltage does not exceed the maximum rating specified.

Short-circuit protective devices with slash voltage ratings (e.g. 480Y/277 V AC) can be applied only in solidly grounded networks where the voltage from line-to-ground does not exceed the lower of the two ratings (e.g. 277 V AC), and the voltage from line-to-line does not exceed the higher of the two ratings (e.g. 480 V AC). The lower rating represents the device's interrupting capability per pole.

Depending on the how they are applied, manual motor starters carry either straight ( $\Delta$ ) or slash (/) voltage ratings.

Rating type	Maximum voltage
Manual Motor Controller	600 $\Delta$
Manual Motor Controller, Suitable as Motor Disconnect	600 $\Delta$
Manual Motor Controller, Suitable for use in Group Installations	600 $\Delta$
Manual Motor Controller, Suitable for Tap Conductor Protection in Group Installations <sup>1)</sup>	600 $\Delta$
Manual self-protected Combination Motor Controller (Type E for UL)	600Y/347 V
Combination Motor Controller (Type F for UL)	600Y/347 V
Protection of ABB Micro drives	480Y/277 V

<sup>1)</sup> MS132/MO132 and MS165/MO165 only

Table 23: Straight vs. slash voltage ratings

## 7.2.4 Short-circuit current ratings

Short-circuit current ratings (SCCR) are tested values for motor control and protection devices to ensure safe reaction during short-circuits and ground faults. Since even low-level faults are capable of producing incredible amounts of energy, unprotected equipment can easily cause damage to the installation and endanger personnel within close proximity. Short-circuit current ratings have been mandatory for industrial control panels since 2006.

A complete list of ABB's tested SCCR can be accessed online through our SOC selection tool (<http://applications.it.abb.com/SOC/page/selection.aspx>).

## 7.2.5 Components requiring short-circuit current ratings

All power circuit components for industrial control panels are required to have marked short-circuit current ratings expressed in kiloamperes and voltage. This includes devices such as:

- Disconnect switches
- Branch circuit protective devices
- Branch circuit fuse holders
- Load controllers
- Motor overload relays
- Terminal blocks
- Busbars

ABB manual motor starters are tested for short-circuit current ratings in a wide variety of applications. SCCR values for manual motor starters may differ depending on how they are applied. See Chapter 7.1.6 Selecting the right Short Circuit Current Ratings (SCCR) level for your UL application for more guidance regarding the selection.

## 7.2.6 Standard (low) fault ratings - Mandatory

In order for electrical products to be certified as suitable for use in motor applications, they must be tested to a minimum standard value based on the size and type of the device. These are referred to as standard fault or low fault ratings. The table below shows the standard values for motor controllers according to UL 60947-4-1 and CSA C22.2 60947-4-1.

<b>Standard fault test current, rms symmetrical</b>	<b>Maximum hp 600 V AC or less</b>	<b>Maximum kW</b>	<b>Maximum Amps 600 V AC – 1500 V AC</b>
<b>1 kA</b>	0 – 1 hp	0 – 0.746 kW	--
<b>5 kA</b>	Over 1 – 50 hp	Over 0.746 – 38 kW	0 – 50 A
<b>10 kA</b>	Over 50 – 200 hp	Over 38 – 149 kW	Over 50 – 200 A
<b>18 kA</b>	Over 200 – 400 hp	Over 149 – 298 kW	Over 200 – 400 A
<b>30 kA</b>	Over 400 – 600 hp	Over 298 – 441 kW	Over 400 – 600 A
<b>42 kA</b>	Over 600 – 900 hp	Over 441 – 671 kW	Over 600 – 850 A
<b>85 kA</b>	Over 900 – 1600 hp	Over 671 – 1193 kW	Over 850 – 1500 A
<b>100 kA</b>	Over 1600 hp	Over 1193 kW	Over 1500 A

Table 24: Standard (low) fault ratings – mandatory. Note: for a manual motor controller intended for use as a means of disconnection, the minimum short-circuit current rating is 5kA. The information above is based on UL 60947-4-1 Table 9.3.4.2.1DV.1.1.1 and is intended for reference only.

The standard fault value is also the assumed rating for unmarked components.

IEC refers to standard fault current as a prospective current “r”.

## 7.2.7 High fault ratings - Optional

The standard fault values shown in the previous chapter are the minimum requirements for all motor control components. Since the available fault current for a given installation can vary drastically, standard fault ratings alone are often too low for many applications. For this reason, manufactures, including ABB, often choose to test their devices beyond the minimum requirements. Any short-circuit testing above the minimum standard fault level and up to a maximum of 200 kA is referred to as a high fault rating.

There are two methods for testing high fault SCCRs. The first method, referred to as component-level testing, is performed in an enclosure, but with the upstream short-circuit protective device mounted separately in the open air. This is common for devices intended to be supplied separately from the short-circuit protection. The second method, which applies to combination starters, involves testing with all components in a single enclosure. This is referred to as combination motor controller (CMC) testing. CMC testing is common for devices supplied as a complete assembly (e.g. enclosed starters).

IEC refers to high fault current as rated conditional current  $I_q$

## 7.2.8 Defined acceptance criteria

Failure of components under fault conditions can lead to safety concerns for personnel working in close proximity to electrical equipment. To outline what constitutes a pass, the harmonized UL 60947-4-1 and CSA C22.2 No.60947-4-1 standards define acceptance criteria for these components. Several criteria exist for all devices:

- The short-circuit protective device successfully interrupts the fault
- The enclosure door has not blown open, and it remains possible to open it manually
- No damage to, or separation between, the conductors and the terminals
- No damage to the insulating bases of live parts, and no access to current carrying parts

For Combination Motor Controllers, the included circuit-breaker, switch, or manual motor starter should be capable of being manually operated, and should not be damaged, exposing conductive parts.

In addition to the above criteria, a distinction is made between two types of coordination: Type 1 and Type 2. This pertains to the suitability of components for continued service following a fault.

### 7.2.8.1 Type 1 coordination

Type 1 coordination allows some components, such as the controller and overload protection device, to sustain damage such that they become inoperable following a short-circuit fault. This coordination type requires that these components are replaced before re-commissioning.

### 7.2.8.2 Type 2 coordination

Type 2 coordination requires that no damage to the overload protection and other components occurs, with the exception that the contacts of the contactor or starter are allowed to be welded. This welding must be easily separated by manual effort (e.g. with a screwdriver). Both the overload tripping performance and controller switching capabilities are verified following the short-circuit test.

## 7.2.9 Calculating the available fault current for a facility

What rating do I need? The necessary short-circuit current rating for any device is determined based on the available fault current at its point of installation.

Most industrial and commercial buildings are supplied by one or more transformers providing incoming power to the facility. Using rated information from these transformers, it is possible to calculate the available fault current for any installation within the building. UL 508A provides the following formulas for determining available fault current in circuits containing transformers with isolated secondary windings.

---

#### Available fault current beyond single-phase transformers

$$I_{sc} = \frac{\left( \frac{kVA \times 1000}{V_{secondary}} \right)}{Z\%}$$

---

---

#### Available fault current beyond 3-phase transformers

$$I_{sc} = \frac{\left( \frac{kVA \times 1000}{V_{secondary} \times \sqrt{3}} \right)}{Z\%}$$

---

$$\sqrt{3} \approx 1.732$$

The available fault current directly at a transformer's secondary terminals  $I_{sc}$  can be calculated from the transformer full-load current  $kVA$ , the secondary voltage line-to-line  $V_{secondary}$  and the transformer impedance  $Z\%$ . For transformers with an unmarked impedance, this can be assumed to be 2.1 % (0.021  $\Omega$ ).

Let's consider a facility supplied by a 3-phase, 3000 kVA transformer with an isolated secondary winding producing 480 V AC line-to-line, and with a marked impedance of 5.75%. Using the formula above, we can calculate the maximum available fault current for this facility to be just under 63 kA (62.755 A).

Since this calculation does not account for any additional impedance from the wires, and also assumes infinite utility source power, the calculated value can be assumed to be "worst-case" for any installation supplied from this power source.

### 7.2.10 Additional current limiting devices

In addition to transformers, other devices, such as some types of fuses and circuit-breakers, also serve to limit the available fault current within a facility. The published let-through energy  $I^2t$  and peak let-through  $I_p$  can be used to determine the load-side available fault current. The higher of these two ratings is the available fault current beyond the device.

Using our example above, we know that our facility has a maximum available fault current of 63 kA. Let's assume that for a 63 kA fault at 480 V AC, a current-limiting circuit-breaker as has an  $I^2t$  of 30 kA<sup>2</sup>s, and an  $I_p$  of 27 kA. The available fault current downstream from this circuit-breaker is 30 kA.

In this example, the required SCCR for all components installed beyond this circuit-breaker must be equal to, or greater than, 30 kA at 480 V AC.

## 7.3 Defining branch circuits

Electrical distribution within a facility requires the coordination of many circuits to loads. Beyond the point of the service entrance, all circuits leading away are considered feeders or feeder taps, until just ahead of a load. The circuit between the load-side terminals of the final overcurrent protective device and the load itself is called the branch circuit. This also means that the branch circuit protective device is actually part of the feeder circuit, not the branch. The figure below shows an example of this.

#### Feeder vs. branch circuits

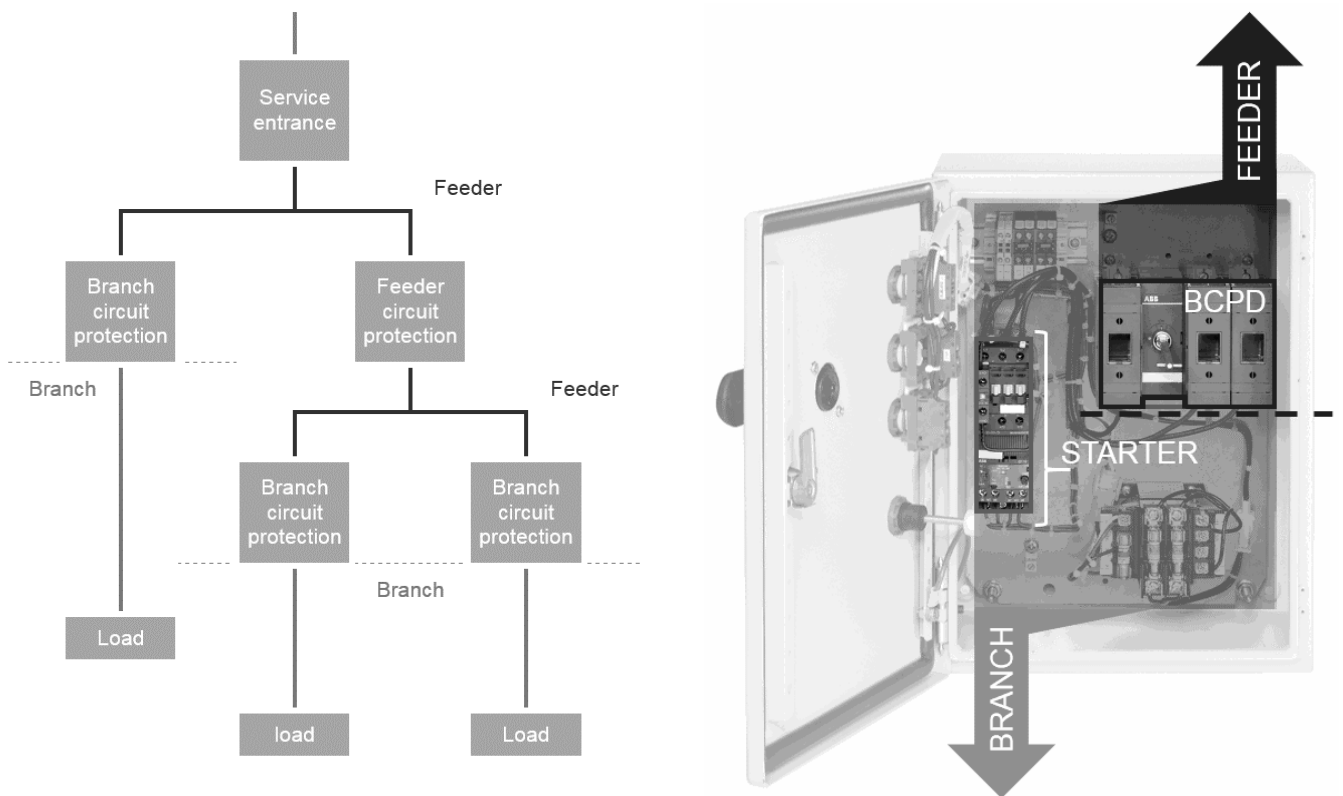

Figure 36: Defining branch circuits.

Manual motor starters are suitable for branch circuit protection when tested as Type E or F combination motor controllers. However, these devices cannot be used for providing protection of feeder circuits. Feeder circuit protection is typically provided using either fuses, UL 489 / CSA C22.2 No.5 molded case or UL 1066 / CSA C22.2 No.31 power circuit-breakers.

The term “branch circuit’ applies regardless of the type of load. Common load types for industrial and commercial applications include motors, heaters, and lamps. The requirements for motor branch circuits are more intense than other load types, so the following section reviews these requirements in detail.

## 7.4 Functional requirements for all motor branch circuits

The installation standards for North America require that each motor branch circuit contains electrical components capable of meeting four functional requirements: a disconnect means, short-circuit and ground-fault protection, a control means, and overload protection. This can be achieved of using either multiple components or a single device. A detailed description of the functional branch requirements will be shown in the next chapter.











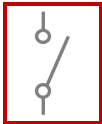









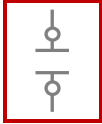



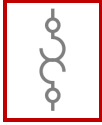

		Functional branch requirements	Components					Combination Motor Controllers		
Starter	Combination starter	 <p><b>1. Disconnect means</b></p>	 <b>Fusible disconnect switches</b> UL 98 CSA C22.2 No.4	 <b>Non-fusible disconnect switches</b> UL 98 CSA C22.2 No.4	 <b>Inverse-time circuit-breakers</b> UL 489 CSA C22.2 No.5	 <b>Molded case switches</b> UL 489 CSA C22.2 No.5	 <b>Manual motor starters</b> UL 60947-4-1 CSA C22.2 No.60947-4-1	 <b>Combination Motor Controllers</b> UL 60947-4-1 CSA C22.2 No.60947-4-1		
		+	 <b>Fuses</b> UL 248 CSA C22.2 No.248	 <b>Inverse-time circuit-breakers</b> UL 489 CSA C22.2 No.5	 MMS only when Type E or F			 <b>Combination Motor Controllers</b> UL 60947-4-1 CSA C22.2 No.60947-4-1		
		+	 <p><b>3. Control means</b></p>	 <b>Contactors</b> UL 60947-4-1 CSA C22.2 No.60947-4-1	 <b>Softstarters</b> UL 60947-4-1 CSA C22.2 No.60947-4-1	 <b>Variable frequency drives</b> UL 508C CSA C22.2 No.274	 <b>Non-fusible disconnect switches</b> UL 60947-4-1 CSA C22.2 No.60947-4-1	 <b>Manual motor starters</b> UL 60947-4-1 CSA C22.2 No.60947-4-1	 <b>Combination Motor Controllers</b> UL 60947-4-1 CSA C22.2 No.60947-4-1	
		+	 <p><b>4. Overload protection</b></p>	 <b>Overload relays</b> UL 60947-4-1 CSA C22.2 No.60947-4-1	 <b>Universal motor controllers</b> UL 60947-4-1 CSA C22.2 No.60947-4-1	 <b>Manual Motor Starters</b> UL 60947-4-1 CSA C22.2 No.60947-4-1				 <b>Combination Motor Controllers</b> UL 60947-4-1 CSA C22.2 No.60947-4-1
		 							 <b>Combination Motor Controllers</b> UL 60947-4-1 CSA C22.2 No.60947-4-1	
		 <p><b>1a. Local disconnect (if required)</b></p>	 <b>Non-fusible disconnect switches</b> UL 60947-4-1 CSA C22.2 No.60947-4-1	 <b>Manual motor starters</b> UL 60947-4-1 CSA C22.2 No.60947-4-1	...or any shown above next to 1. disconnect means					

Table 25: Functional requirements for all motor branch circuits

The chart above shows a graphical representation of the functional requirements for all motor branch circuits. Manual motor starters are capable of meeting all of the requirements listed above. However, in order for manual motor starters to be used for short-circuit and ground-fault protection, they must be additionally certified as Type E or F combination motor controllers.

### 7.4.1 Disconnect means for the motor and branch circuit

#### acc. to NEC Article 430.101 / CEC Section 28-600

The branch disconnect serves as the primary means for isolating the motor and the electrical equipment from the power source, often for maintenance purposes. The disconnect means is provided with accessories to allow its function from outside the enclosure. To meet safety requirements, the disconnect means must be lockable in the off position and must be visible from the motor location. Manual motor starters can be used as the main branch disconnect means when marked “Suitable as Motor Disconnect” and installed on the load side of the branch short-circuit and ground-fault protective device.

### 7.4.2 Short-circuit and ground-fault protection for the motor and branch circuit

#### acc. to NEC Article 430.51 / CEC Section 28-200

Each motor branch circuit requires a device that can protect the motor, the electrical components, and the conductors in the event of a short-circuit or ground fault. Conventionally, this can only be achieved using either fuses or an inverse-time (e.g. thermal-magnetic) circuit-breaker. However, through Combination Motor Controller testing, the available options are expanded to also include recognized instantaneous-trip (magnetic only) circuit-breakers and manual motor starters, which can offer cost-effective alternatives for customers.

### 7.4.3 Motor control means

#### acc. to NEC Article 430.81 / CEC Section 28-500

The controller provides the means for the routine starting and stopping of the motor. Controllers range in complexity from the very basic manual switches to continuous speed control using variable frequency drives. Depending on the size of the motor and the type of application, customers can select from a wide variety of motor control options available from ABB. One critical aspect for selection is to ensure that the control means is properly rated for the type of load to be controlled, in this case “AC Motor” or “DC Motor” ratings. Not all controllers are suitable for use in motor applications. Additionally, it is important to consider the electrical durability of the control device, as some devices suitable for motor control are not designed with this intention (e.g. molded case circuit-breakers).

### 7.4.4 Overload protection for the motor and branch circuit

#### acc. to NEC Article 430.31 / CEC Section 28-300

Each motor branch circuit requires a device that can protect the motor, the electrical components, and the conductors from excessive heating due to motor overloads or failures to start. Although most devices used for short-circuit and ground-fault protection also offer thermal protection against overheating, very few motor applications allow for the use of inverse-time circuit-breakers alone to protect the installation against overload conditions (exc. 1 hp or less, non-automatically started).

### 7.4.3 Local motor disconnect

#### acc. to NEC Article 430.102 / CEC Section 28-604

An additional disconnect means is required if the main disconnect means is not within sight of the motor installation or exceeds a distance of 15 m (50 ft.) in the U.S. and 9 m (29.5 ft.) in Canada. Typically, customers will use enclosed UL 60947-4-1 / CSA C22.2 No. 60947-4-1 manual motor starters or non-fusible disconnects when marked “Suitable as Motor Disconnect”, since the local disconnect is already positioned downstream from the short-circuit and ground-fault protective device. However, all devices suitable for the main disconnect means can also be selected for this purpose.

See Chapter 7.1.5 Categorizing manual motor starters, for a list of suitable products for each functional requirement by Category Code (CCN).



## 7.5 Product offering for north American applications

ABB provides a comprehensive manual motor starter. The manual motor starters are divided into three ranges to simplify selection, coordination, and installation:

- MS116 standard range up to 32 A
- MS132 / MO132 high performance ranges up to 32 A
- MS165 / MO165 high performance ranges up to 80 A



**MS116**  
0.10 ... 32 Amps  
Tripping Class 10A



**MS132 / MO132**  
0.10 ... 32 Amps  
Tripping Class 10 (MS only)



**MS165 / MO165**  
10 ... 80 Amps  
Tripping Class 10 (MS only)

The chart below shows an overview of ratings for manual motor starters by product type.

Rating	Manual motor starter type				
	MS116	MS132	MS165	MO132	MO165
Manual Motor Controller	X	X	X	X	X
Manual Motor Controller, Suitable as Motor Disconnect	X	X	X	X	X
Manual Motor Controller, Suitable for use in Group Installations	X	X	X	X	X
Manual Motor Controller, Suitable for Tap Conductor Protection in Group Installations		X	X	X	X
Manual self-protected Combination Motor Controller (Type E)		X	X		
Combination Motor Controller (Type F)		X	X	X	X
Protection of ABB Micro drives		X		Contact ABB	

Table 26: Product offering for North American applications.

For additional information regarding product selection, please see our Main Catalog for Motor Control and Protection, at <https://library.abb.com>. > All Categories > Products > Low Voltage Products and Systems > Control Product > Manual Motor Starters.

## 7.6 Suitable applications for manual motor starters for North America

For North America, the suitable applications for manual motor starters can be divided into two categories: those which require the use of upstream branch circuit protection (e.g. circuit-breakers or fuses), and those which require no additional upstream branch protection.

Recall from the earlier discussion in Chapter 7.1.5 Categorizing manual motor starters that manual motor starters are classified by UL under two categories:

- Manual Motor Controllers (NLRV)
- Combination Motor Controllers (NLDX)

These categories follow the same division in regard to the need for upstream coordination.

First, we will review those applications specific for Manual Motor Controllers (NLRV), which require upstream branch circuit protection.

### 7.6.1 Defining Manual Motor Controllers (NLRV)

ABB manual motor starters are initially tested as Manual Motor Controllers (NLRV). A manual controller is defined as a hand-operated switching device whose contacts are controlled by the position of a mechanical actuator. These controllers can optionally be provided with the following functions:

An instantaneous trip element for short-circuit protection (not suitable for branch circuit protection without further testing)

- Motor overload protection
- Suitability for motor disconnecting means, on the load-side of the branch circuit protective device
- Suitability for tap conductor protection in group installations

These additional functions are considered “optional” for devices within this category. To understand this, consider non-fusible disconnect switches tested according to UL 60947-4-1 / CSA C22.2 No. 60947-4-1. These devices feature no internal releases and are therefore not suitable for load protection. Even so, both manual motor starters and non-fusible **disconnect switches are classified within the same category NLRV.**

---

#### Manual motor starters, tested as Manual Motor Controllers (NLRV)

---



Tested according to UL 60947-4-1 and CSA C22.2 No. 60947-4-1 as Manual Motor Controllers (NLRV)

- Load control (AC-1, AC Motor)
- Motor overload protection
- Component-level short-circuit current ratings with fuses and circuit-breakers

Optional additional testing within this category includes

- Suitable as motor disconnect
- Suitable for use in group installations
- Suitable for tap conductor protection in group installations

---

Figure 37: Manual motor starters, tested as Manual Motor Controllers (NLRV).

**7.6.1.1 Manual starters (non-combination)**

Manual starting methods offer a cost-effective alternative to remotely controlled starters. Manual starters feature a front-facing switching mechanism, typically in the form of a rotary knob, toggle switch, or pushbutton. This mechanism is the interface for direct ON/OFF control of the load. What sets manual motor starters apart from simple motor switches (e.g. non-fusible disconnect switches) is the inclusion of protective releases. If a fault occurs, the switching mechanism will trip the device handle to either an OFF or designated TRIP position.

As these manual starters still require that additional branch protection be provided separately upstream, they are commonly identified using the terms “non-combination” or “non-combo”.

Manual starters are often used on smaller 1- or 3-phase motors, typically 10 hp or less, and are popular in HVAC applications. They can either be enclosed or provided with accessories for flush mounting directly to a wall or panel door.

The examples in the figure below show manual motor starters applied as non-combination, single-motor starters. In addition to providing the means for motor control and overload protection, they can be used as the main branch disconnect when marked “Suitable as Motor Disconnect” and installed on the load side of the branch circuit protective device.

**Manual motor starters as non-combination manual starters**

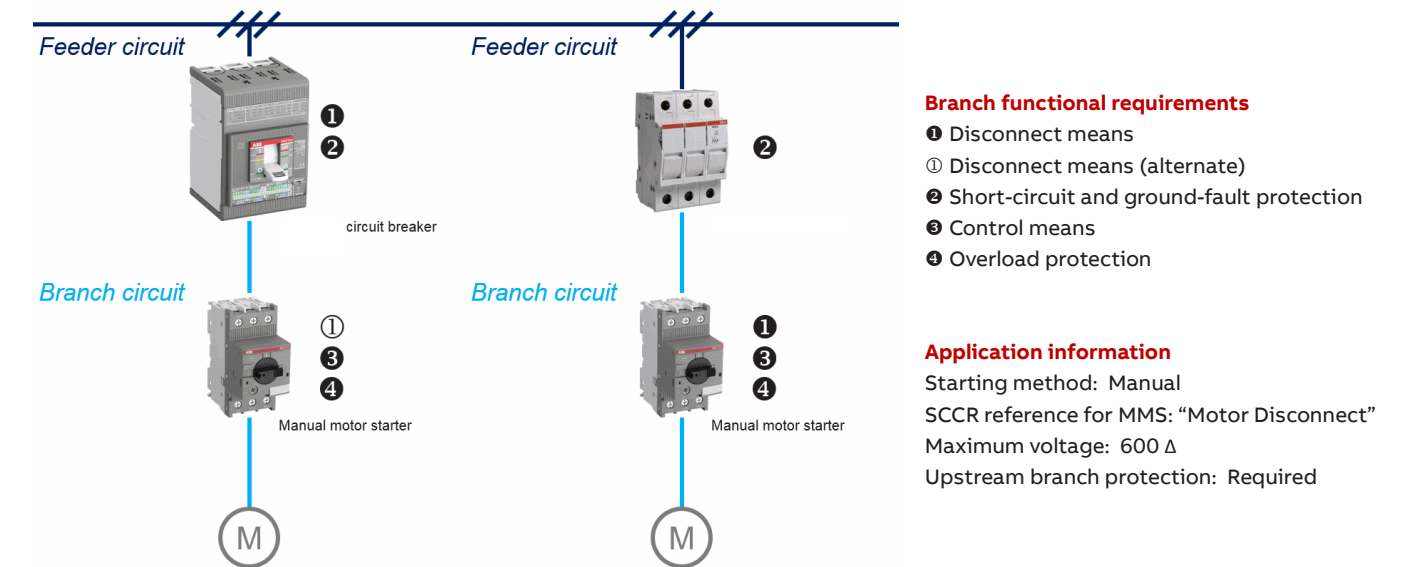

Figure 38: Manual motor starters as non-combination manual starters.

For information regarding the use of manual motor starters as manual self-protected Combination Motor Controllers (Type E), without the need for upstream branch circuit protection, see Chapter 7.6.2 Defining Combination Motor Controllers (NKJH).

**7.6.1.2 As part of a magnetic or solid-state starter (non-combination)**

Although manual motor starters are suitable for manually controlling motors by themselves, they can be combined with another controller, such as a contactor, to allow for remote control. This also increases the electrical durability of the starter. In these applications, the manual motor starters serve the primary function for motor and branch overload protection.

Manual motor starters can offer advantages versus conventional overload relays, including:

- ✓ Up to five direct-mount auxiliaries and signaling contacts
- ✓ Undervoltage and remote (shunt) tripping accessories
- ✓ Visible trip indication (only MS132 and MS165)
- ✓ Direct-opening overload protection to ensure functionality even if contactor welds

Coupling adaptors are available for directly mounting to AF contactors and PSR softstarters to reduce installation time and panel space.

Applications include anywhere thermal (bi-metallic) overload relays used today.

The examples in the figure below show manual motor starters applied in non-combination, single-motor applications. The use of the additional controller (e.g. contactor) allows these starters to be remotely controlled. In addition to providing overload protection, the manual motor starter can also be used as the main branch disconnect when marked “Suitable as Motor Disconnect” and installed on the load-side of the branch circuit protective device.

**Manual motor starters as non-combination starters**

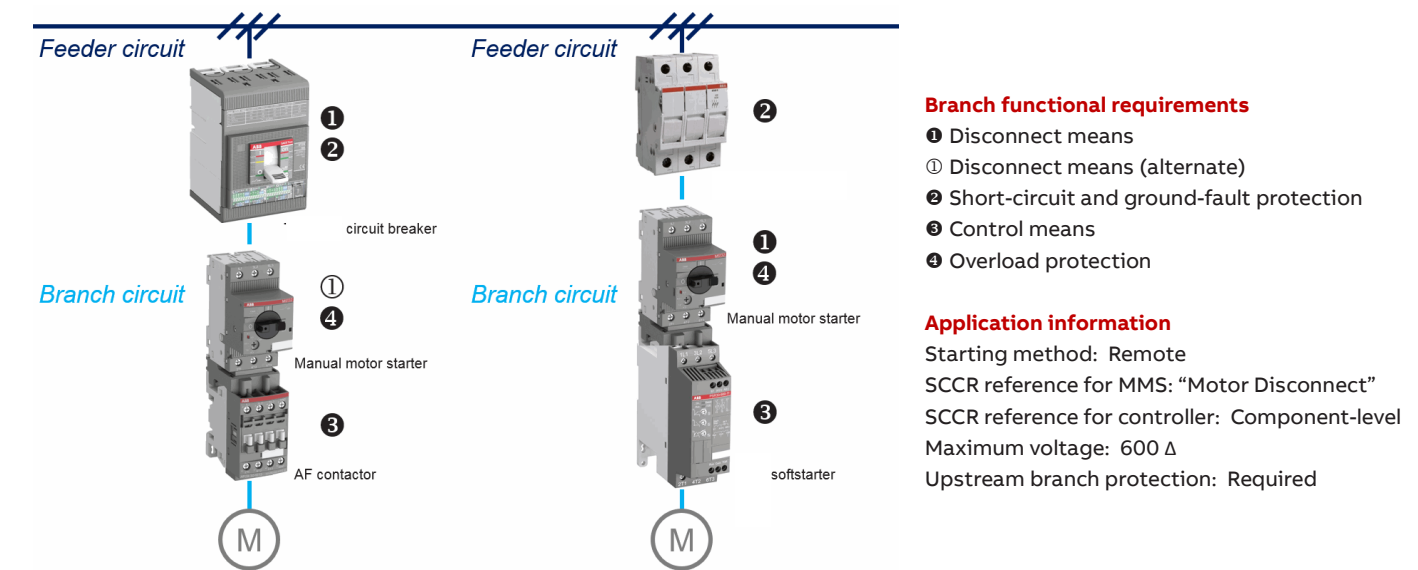

Figure 39: Manual motor starters as non-combination starters.

For information regarding the use of manual motor starters with AF contactors as Combination Motor Controllers (Type F), without the need for upstream branch circuit protection, see Chapter 7.6.2.1 Manual self-protected Combination Motor Controllers, Type E.

### 7.6.1.3 Local motor disconnect

acc. to NEC Article 430.102 / CEC Section 28-604

The North American installation standards require that each motor circuit includes a means of safely disconnecting the motor from its supply power. This is typically utilized for maintenance purposes. With very few exceptions, this disconnect means must not exceed a distance of 15 m (50 ft.) in the U.S. and 9 m (29.5 ft.) in Canada from the motor itself and must be within sight of the installation. If the primary disconnect means does not meet these criteria, a secondary, local disconnect must be installed, often in the form of an enclosed switch.

Manual motor starters, when additionally marked “Suitable as Motor Disconnect”, are suitable for providing a means of locally disconnecting the motor. The inclusion of an at-motor overload trip indication and reset feature can allow for quick and simple diagnostic troubleshooting and maintenance, reducing downtime. At-motor short-circuit protection also help to mitigate fault detection issues caused by the increased wire impedance of long motor cables.

The ABB manual motor starter handles feature a trip-free mechanism, meaning the device will trip even if the handle is locked in the ON position or held by hand. They are capable of being locked in the OFF position directly, and accessory enclosures and through-door handles are available that meet the requirements for lock-out / tag-out and are 3x padlock able.

Manual motor starters provide advantages versus conventional non-fusible disconnect switches, including:

Local at-motor overload, short-circuit, and phase loss protection

Undervoltage and remote (shunt) tripping accessories

Lockable device handles without accessory (excludes Type MS116)

Reduced downtime by providing greater diagnostic capabilities on location

Local motor disconnects are common in material handling applications, such as conveyors, but can also be found in industrial applications employing centralized motor control centers.

#### Manual motor starters as local motor disconnects

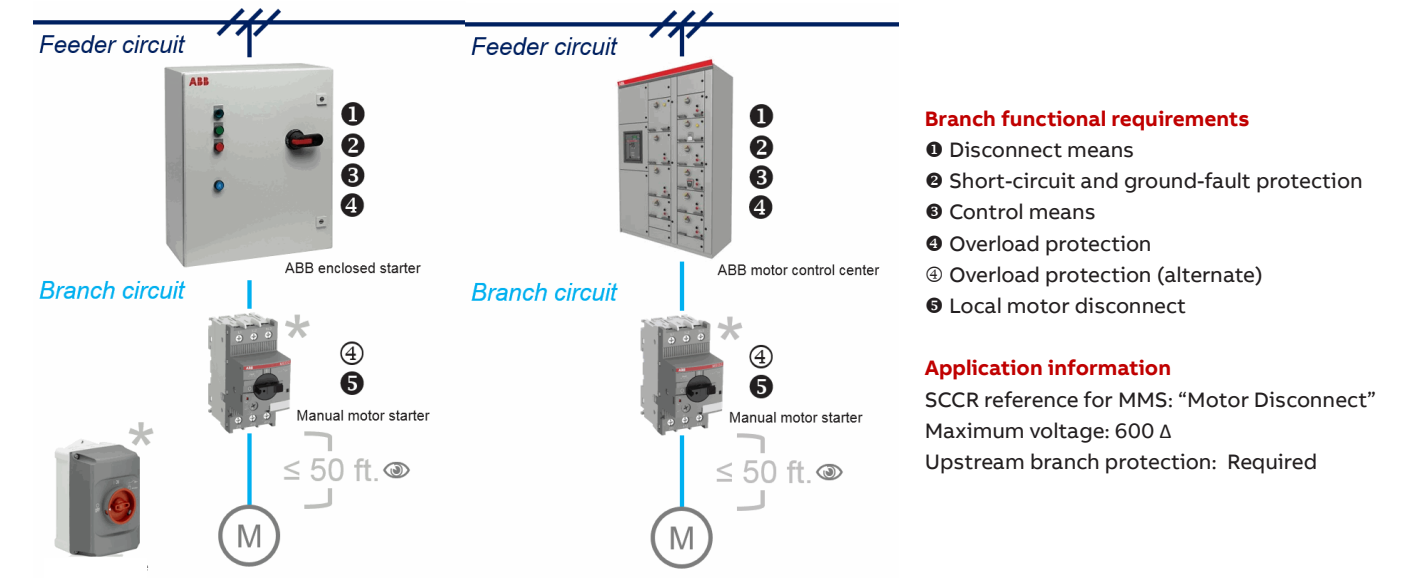

Figure 40: Manual motor starters as non-combination starters.

### 7.6.1.4 Group installations

A group installation is defined as two or more motors, or one or more motors and other loads, protected by a single branch circuit protective device (BCPD). Group installations help to reduce both panel space, reduce the waste heat in the panel and cost.

Group installations are permissible under NEC Article 430.53 in three instances, when either:

1. Each motor does not exceed 1 hp (6 A), and the upstream BCPD is no larger than 15 A.
2. Each motor circuit is individually protected against overload, with the BCPD sized for the smallest motor in accordance with individual branch requirements. The BCPD should not open under normal operating conditions for any load.
3. Each load is controlled, and each motor protected against overload conditions by devices listed for use in group installations. The BCPD must additionally be sized properly to protect the group. As an exception, the controllers and overload protection do not need to be listed for use in group installations if the upstream BCPD does not exceed the maximum size allowed for the individual motor circuit.

In all instances, the individual load tap conductors must have an ampacity of at least 125% of the motor full-load current. If the distance from the BCPD to the individual motor overload protection is not greater than 7.5 meters (25 feet), the tap conductors can be reduced to 1/3 the ampacity of the branch conductors. For longer distances, the ampacity of the individual load tap conductors must be equal to the branch circuit conductors. When the individual load tap conductors are sized less than the branch circuit conductors, they must be protected from physical damage by being enclosed in a raceway or another approved method.

Group installations are typically employed in Industrial Control Panels designed to control multiple motors and other loads. Examples include a set of similarly sized loads (e.g. a fan bank), or a combination of a large main load and smaller support loads (e.g. lubrication pumps or cooling fans).

ABB manual motor starters are suitable for use in group installations, and provide:

- ✓ An individual, lockable disconnect means for each load circuit
- ✓ Quick and compact group wiring using three-phase accessory busbar and coupling adaptors

#### Manual motor starters in a group installation

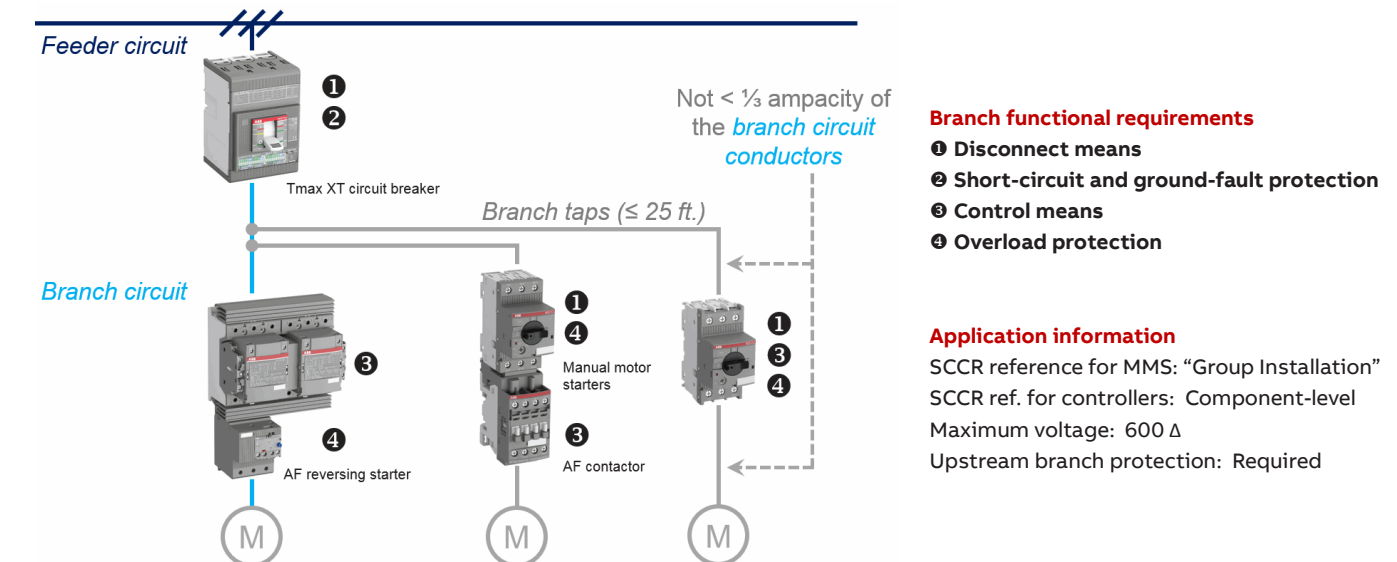

Figure 41: Manual motor starters in a group installation.

### 7.6.1.5 Tap conductor protection in group installations

Please note: as of the date of this publication, the following application is not applicable in Canada under CSA C22.1 The Canadian Electrical Code (CEC), Section 28.

When manual motor starters are employed in standard group installations, their ability to protect against short-circuits is not taken into consideration. In an effort to credit these devices for protection against short-circuits, the National Electrical Code® (NEC) allows manual motor starters marked “Suitable for Tap Conductor Protection in Group Installations” to protect the individual group taps, instead of the upstream group BCPD. This allows the size of the individual tap conductors to be smaller and more cost-effective than in standard group installations, as well as the potential for larger groups and for greater disparity between individual load sizes.

When the individual load tap conductors do not exceed a distance of 3 meters (10 feet) from the BCPD before terminating to a manual motor starter marked “Suitable for Tap Conductor Protection in Group Installations”, they are allowed to be sized with an ampacity as low as 1/10 the rating of the upstream group BCPD.

The conductors between the manual motor starter and the load are sized based on the NEC rules for the load itself and are no longer a factor of the branch circuit conductor ampacity as they are in standard group installations.

Manual motor starters marked “Suitable for Tap Conductor Protection in Group Installations” can additionally be used for the overcurrent protection of control transformers, eliminating the need for fuses or a UL 489 / CSA C22.2 No.5 circuit-breaker.

Tap conductor protection offers advantages versus conventional group installations, including:

- ✓ Smaller and more cost-effective wire sizes between the BCPD and each individual load
- ✓ Larger groups with greater disparity between load sizes
- ✓ Protection of control transformers

#### Manual motor starters for tap conductor protection in group installations

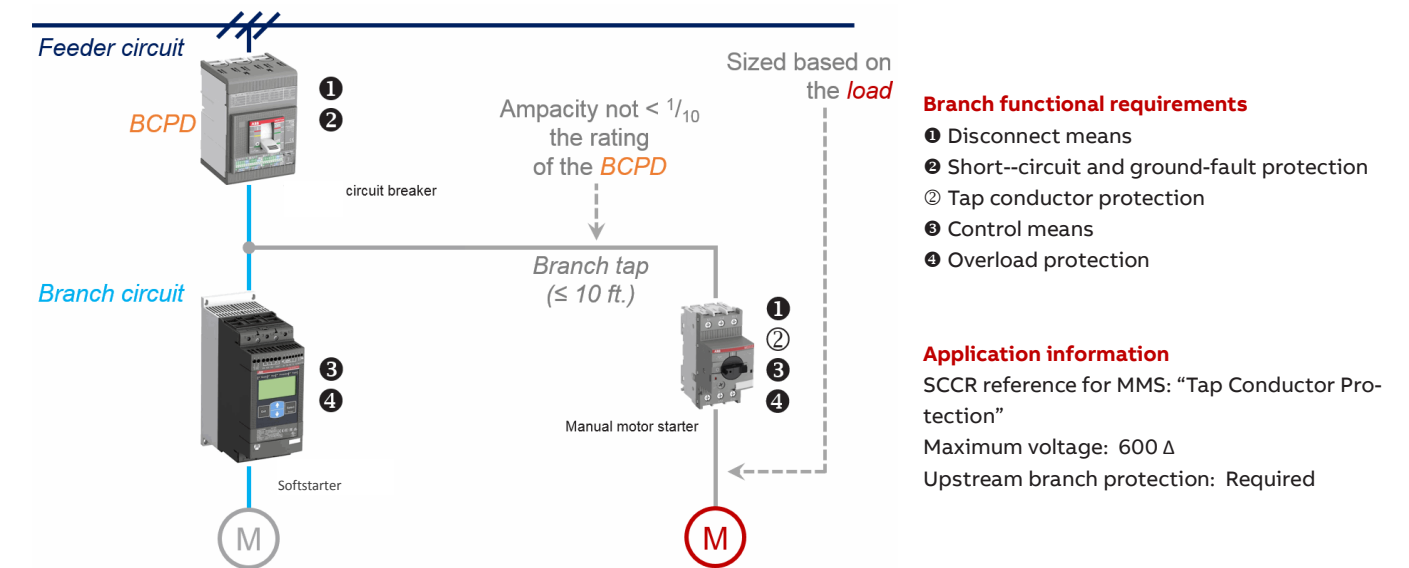

Figure 42: Manual motor starters for tap conductor protection in group installations.

### 7.6.2 Defining Combination Motor Controllers (NKJH)

A Combination Motor Controller (CMC) is a single device, or assembly of devices, which provides the combined functions of branch circuit disconnect means, short-circuit protection, control means, and overload protection. These are:

- Listed combinations tested according to UL 60947-4-1 and CSA C22.2 No.60947-4-1
- Tested in a single enclosure
- Tested for a complete branch short-circuit current rating; Type 1 or Type 2 coordination

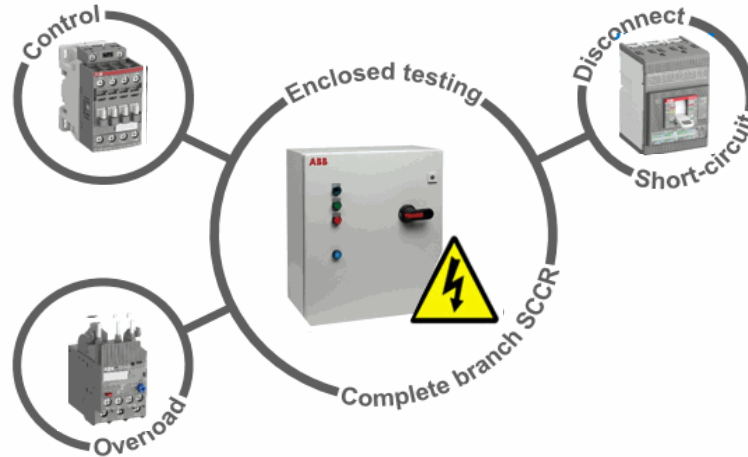

Figure 43: Defining Combination Motor Controllers (NKJH).

The figure below shows the currently six construction types for Combination Motor Controllers. Manual motor starters are used for Types E and F.

Tested in an enclosure	Type A	Type B	Type C	Type D	Type E	Type F (two-component)	Type F (three-component)	
Disconnect means Short-circuit and ground-fault protection Control means Overload protection Tested combination SCCR	Motor disconnect UL 98 or UL 489	Motor disconnect UL 98 or UL 489	Inverse-time circuit-breaker UL 489	Instantaneous-trip circuit-breaker UL 489 	Self-protected control device UL 60947-4-1	Manual self-protected combination controller UL 60947-4-1	Manual self-protected combination controller UL 60947-4-1	
	Fuses UL 248	Motor short-circuit protector UL 60947-4-1				Magnetic or solid-state motor controller UL 60947-4-1	Magnetic or solid-state motor controller UL 60947-4-1	Magnetic or solid-state motor controller UL 60947-4-1
	Magnetic or solid-state motor controller UL 60947-4-1	Magnetic or solid-state motor controller UL 60947-4-1	Magnetic or solid-state motor controller UL 60947-4-1	Magnetic or solid-state motor controller UL 60947-4-1			Manual self-protected combination controller UL 60947-4-1	Overload relay UL 60947-4-1
	Overload relay UL 60947-4-1	Overload relay UL 60947-4-1	Overload relay UL 60947-4-1	Overload relay UL 60947-4-1				
	Straight voltage rated (e.g. 480 Δ)	Straight voltage rated (e.g. 480 Δ)	Straight voltage rated (e.g. 480 Δ)	Straight voltage rated (e.g. 480 Δ)	Slash voltage rated (e.g. 480Y/277V)	Slash voltage rated (e.g. 480Y/277V)	Slash voltage rated (e.g. 480Y/277V)	

Table 27: Defining Combination Motor Controllers (NKJH) Note: the information above is derived from UL 60947-4-1 and is intended for reference purposes only.

A complete listing of ABB’s tested Combination Motor Controllers can be accessed online on UL’s website, using the keyword “ABB” (<http://ul.com/search/?q=ABB>).



**7.6.2.1 Manual self-protected Combination Motor Controllers, Type E**

Type E represents the only CMC construction type to allow use of a single component. Manual motor starters are the most common example. The term “self-protected” refers to the level of coordinated protection provided, as these combinations are subject to an intense validation process following short-circuit, including thousands of electrical and mechanical operations. For this reason, Type E Combination Motor Controllers ensure proven continuity of service following a fault and provide a level of coordinated protection that exceeds even Type 2.

Due to the compact nature of manual motor starters, Type E Combination Motor Controllers are slash voltage rated (e.g. 600Y/347 V AC). This limits their use to solidly grounded networks for the higher voltages (e.g. above 347 V AC).

Two additional criteria exist for manual motor starters certified as Combination Motor Controllers:

Line-side terminal spacing of 2 inches over-surface (creepage) and 1 inch through-air (clearance) which are similar to the requirements common for UL 489 / CSA C22.2 No.5 circuit-breakers.

A means of visibly differentiating between thermal (overload) and magnetic (short-circuit) trip, so as not to inhibit troubleshooting.

These requirements can be met using either accessories (e.g. terminal feeder blocks and side-mount trip indicators) or inherent design features. MS165 requires no additional accessories to meet the above criteria; MS132 requires only the line-side terminal feeder block (S1-M3-...). Both types feature an integral trip indicator window, which turns red upon tripping of the instantaneous release, indicating a short-circuit.

- ✓ Type E manual self-protected Combination Motor Controllers provide significant advantages for customers by incorporating control, disconnect, overload and short-circuit protection into one, compact and cost-efficient product.

**Manual self-protected Combination Motor Controller (Type E)**

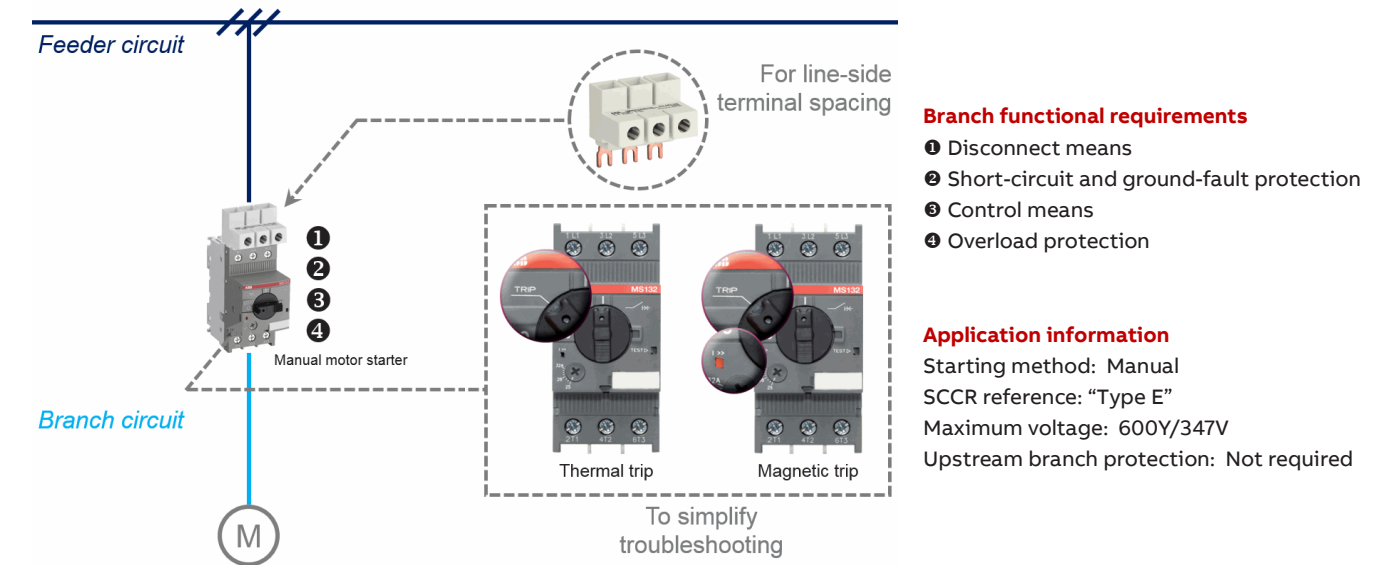

Figure 44: Manual self-protected Combination Motor Controller (Type E).

For information regarding manual starter applications in ungrounded (delta) networks above 347 V AC, see Chapter 7.6.1.1 Manual starters (non-combination).

### 7.6.2.2 Combination Motor Controllers, Type F

Type F constructions are divided into two styles: two-component and three-component assemblies. Two-component Type F assemblies utilize a manual, self-protected device for both short-circuit and overload protection. Three-component Type F assemblies utilize a separate overload relay, and short-circuit protection is provided by a magnetic only (MO) manual motor starter.

The additional criteria for line-side terminal spacing and visible trip indication described in the chapter below are also applicable for Type F Combination Motor Controllers.

Type F Combination Motor Controllers can be tested for either Type 1 or Type 2 coordination.

- ✓ With the inclusion of a contactors for remote control, Type F Combination Motor Controllers increase functionality while still offering customers the benefit of using compact and cost-efficient manual motor starters for branch short-circuit protection.
- ✓ Three-component assemblies provide additional benefits, including selectable Class 10, 20, 30 overload protection (electronic), along with a wiring schematic identical to that of a conventional combination starter (e.g. molded case circuit-breaker, contactor, and overload relay).

#### Combination Motor Controllers (Type F)

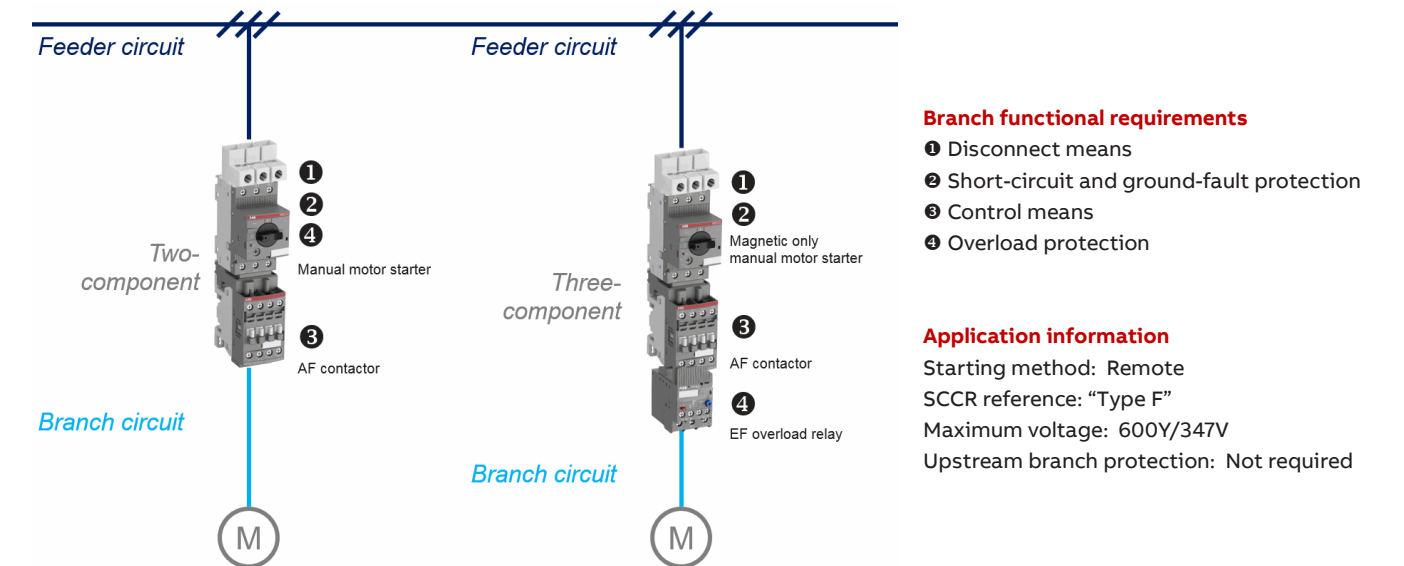

Figure 45: Combination Motor Controllers (Type F)

For information regarding remote starter applications in ungrounded (delta) networks above 347 V AC, see Chapter 7.6.1.2 As part of a magnetic or solid-state starter (non-combination).

**7.6.2.3 Protection of ABB Micro drives**

Type E manual self-protected Combination Motor Controllers can be used for the protection of frequency converters (e.g. variable frequency drives). This requires further component-level short-circuit testing to be performed according to UL 508C. ABB has performed testing to allow the use of manual motor starters for the protection of ACS150 and ACS3xx Micro drives.

The additional criteria for line-side terminal spacing and visible trip indication described in Chapter 7.6.2.1 Manual self-protected Combination Motor Controllers, Type E, are also required for the Type E manual self-protected Combination Motor Controllers used in this application.

- ✓ The use of manual motor starters for drive protection provides customers with a compact and cost-efficient alternative to non-resettable semiconductor fuses.

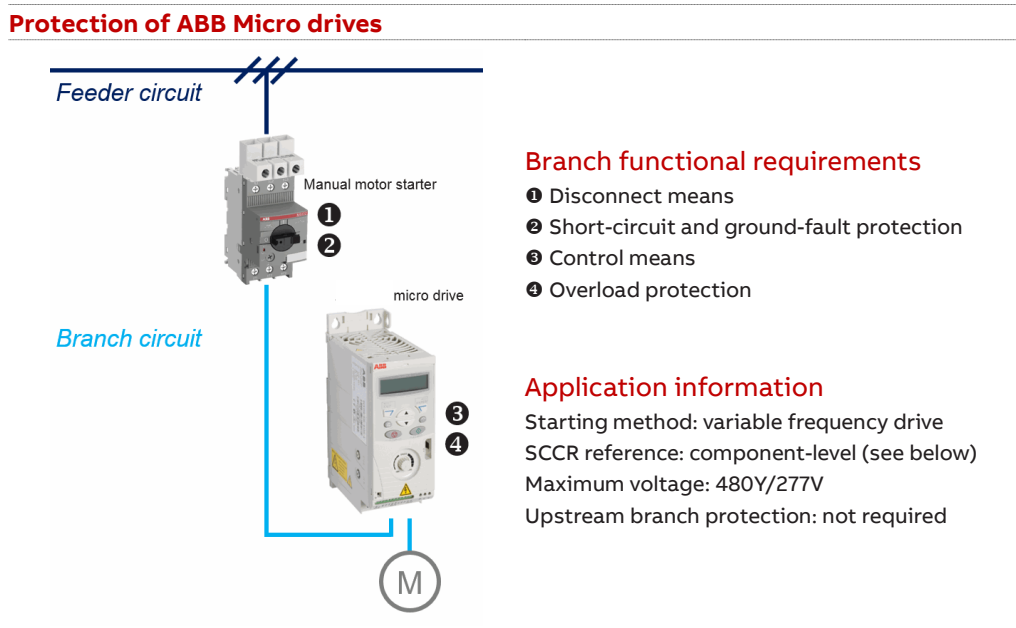

Figure 46: Protection of ABB Micro drives

For more information regarding ABB’s tested combinations with Type E manual self-protected Combination Motor Controllers and ACS150 / ACS3xx Micro drives, please consult the relevant document, which can be accessed from the Download Center(<https://library.abb.com>).

## 8. Glossary

<b>AC</b>	<b>Alternating current</b>
<b>Active power</b>	The power consumed by the motor which is converted into mechanical action.
<b>Ambient temperature</b>	Ambient temperature is the temperature of water, air or surrounding medium where the equipment is used or stored.
<b>DC</b>	Direct current.
<b>Delta connection</b>	The connection type of a motor where the windings are connected in a delta.
<b>Efficiency</b>	The ratio between mechanical output and electrical input. The percentage given indicates how effective the motor is at converting electrical energy to mechanical energy.
<b>Frequency</b>	The number of periodic cycles per unit of time.
<b>FLA</b>	Full Load Amps (sometimes also FLC= Full Load Current), rated-current at rated-load and rated-voltage. This is the amount of current (amps) the motor will draw from the electrical system when producing its rated output horsepower.
<b>I<sub>cm</sub></b>	Rated short-circuit making capacity, see also chapter: 2.2.2 Rated short-circuit making capacity (I <sub>cm</sub> )
<b>I<sub>cu</sub></b>	Rated service short- circuit braking capacity, see also chapter: 2.2.3.1 Rated ultimate short-circuit breaking capacity (I <sub>cu</sub> ) acc. to IEC / EN 60947-2.
<b>I<sub>cs</sub></b>	Rated service short-circuit breaking capacity, see also chapter: 2.2.3.2 Rated service short-circuit breaking capacity (I <sub>cs</sub> ) acc. to IEC / EN 60947-2.
<b>I<sub>cw</sub></b>	Rated short-time withstand current, see also Chapter: 2.2.4 Rated short-time withstand current (I <sub>cw</sub> ).
<b>I<sub>e</sub></b>	The tripping characteristic of the instantaneous short-circuit releases is based on the rated operational current I <sub>e</sub> , which, in the case of the manual motor starter, is the same as the upper value of the setting range.
<b>IE3</b>	Premium-efficiency class for single-speed motors according to IEC 60034-30.
<b>IE4</b>	Super Premium-efficiency class for single-speed motors according to IEC 60034-30 version 2014
<b>IEC</b>	International Electrotechnical Commission which is part of the International Standard Organization.
<b>Inertia</b>	A measure of a body's resistance to change in velocity whether the body is moving at a constant speed or is at rest. The velocity can be rotational or linear.
<b>Inrush peak</b>	A short, high-current transient occurring during the first milliseconds when the motor is started.
<b>LED</b>	Light-emitting diode.
<b>Load torque</b>	The braking torque on the motor shaft caused by the load. If the braking torque is equal or nearly equal to the rated motor torque it can be defined as high load torque.
<b>MEPS</b>	Minimum Energy Performance Standard: a local regulation specifying the minimum required energy performance for energy using products. In Europe the EU MEPS for direct on-line motors is IE3.
<b>MMS</b>	Manual motor starter.
<b>N-end</b>	The end that is normally the non-drive end of an electrical motor.
<b>NEMA</b>	The National Electrical Manufacturers Association (USA).
<b>Network</b>	Several nodes connected to each other with some type of communication medium. A network can be of single link type or multiple link type.

<b>NLRV</b>	UL definition of a Manual Motor Controllers, see also Chapter: 7.6.1 Defining Manual Motor Controllers (NLRV).
<b>NLRV</b>	UL definition of a Combination Motor Controllers, see also Chapter: 7.6.2 Defining Combination Motor Controllers (NKJH).
<b>Noise</b>	Unwanted disturbances in a communication medium that tend to obscure the data content.
<b>Operational voltage</b>	The voltage that is fed to the motor, usually 3-phase.
<b>Overload relay</b>	A device used to avoid overheating of the motor. Can be of electronic or thermal type.
<b>Rated current</b>	The rated current is the current drawn by a fully loaded motor at its specified nominal speed.
<b>Reactive power</b>	The power consumed by the motor which is used for the magnetization of the motor.
<b>RMS</b>	Root Mean Square: The RMS value of an AC supply is the steady DC equivalent, which would convert electrical energy to thermal energy at the same rate in a given resistance.
<b>SCCR</b>	Short Circuit Current Ratings, see also Chapter: 7.1.6 Selecting the right Short Circuit Current Ratings (SCCR) level for your UL application
<b>Tripping Class</b>	The tripping Class defines the starting time at a specific current before tripping occurs. Different classes exist, for example 10, 20, 30 etc. where class 30 allows the longest starting time.
<b>U<sub>e</sub></b>	Rated operation voltage, see also Chapter: 2.2.1 Rated operational voltage (U <sub>e</sub> ).

# 9. Appendix

## Motor rated operational powers and currents

The currents given below concern standard three-phase four-pole cage motors (1500 r.p.m. at 50 Hz 1800 r.p.m. at 60 Hz). These values are given for guidance and may vary according to the motor manufacturer and depending on the number of poles

IEC Motor nominal current: standardized values in grey (according to IEC 60947-4-1 Annex G)										
Motor power	220 V	230 V	240 V	380 V	400 V	415 V	440 V	500 V	660 V	690 V
kW	A	A	A	A	A	A	A	A	A	A
0.06	0.37	0.35	0.34	0.21	0.2	0.19	0.18	0.16	0.13	0.12
0.09	0.54	0.52	0.50	0.32	0.3	0.29	0.26	0.24	0.18	0.17
0.12	0.73	0.7	0.67	0.46	0.44	0.42	0.39	0.32	0.24	0.23
0.18	1	1	1	0.63	0.6	0.58	0.53	0.48	0.37	0.35
0.25	1.6	1.5	1.4	0.9	0.85	0.82	0.74	0.68	0.51	0.49
0.37	2.0	1.9	1.8	1.2	1.1	1.1	1	0.88	0.67	0.64
0.55	2.7	2.6	2.5	1.6	1.5	1.4	1.3	1.2	0.91	0.87
0.75	3.5	3.3	3.2	2.0	1.9	1.8	1.7	1.5	1.15	1.1
1.1	4.9	4.7	4.5	2.8	2.7	2.6	2.4	2.2	1.7	1.6
1.5	6.6	6.3	6	3.8	3.6	3.5	3.2	2.9	2.2	2.1
2.2	8.9	8.5	8.1	5.2	4.9	4.7	4.3	3.9	2.9	2.8
3	11.8	11.3	10.8	6.8	6.5	6.3	5.7	5.2	4	3.8
4	15.7	15	14.4	8.9	8.5	8.2	7.4	6.8	5.1	4.9
5.5	20.9	20	19.2	12.1	11.5	11.1	10.1	9.2	7	6.7
7.5	28.2	27	25.9	16.3	15.5	14.9	13.6	12.4	9.3	8.9
11	39.7	38	36.4	23.2	22	21.2	19.3	17.6	13.4	12.8
15	53.3	51	48.9	30.5	29	28	25.4	23	17.8	17
18.5	63.8	61	58.5	36.8	35	33.7	30.7	28	22	21
22	75.3	72	69	43.2	41	39.5	35.9	33	25.1	24
30	100	96	92	57.9	55	53	48.2	44	33.5	32
37	120	115	110	69	66	64	58	53	40.8	39
45	146	140	134	84	80	77	70	64	49.1	47
55	177	169	162	102	97	93	85	78	59.6	57
75	240	230	220	139	132	127	116	106	81	77
90	291	278	266	168	160	154	140	128	97	93
110	355	340	326	205	195	188	171	156	118	113
132	418	400	383	242	230	222	202	184	140	134
160	509	487	467	295	280	270	245	224	169	162
200	637	609	584	368	350	337	307	280	212	203
250	782	748	717	453	430	414	377	344	261	250
315	983	940	901	568	540	520	473	432	327	313
355	1109	1061	1017	642	610	588	535	488	370	354
400	1255	1200	1150	726	690	665	605	552	418	400
500	1545	1478	1416	895	850	819	745	680	515	493
560	1727	1652	1583	1000	950	916	832	760	576	551
630	1928	1844	1767	1116	1060	1022	929	848	643	615
710	2164	2070	1984	1253	1190	1147	1043	952	721	690
800	2446	2340	2243	1417	1346	1297	1179	1076	815	780
900	2760	2640	2530	1598	1518	1463	1330	1214	920	880
1000	3042	2910	2789	1761	1673	1613	1466	1339	1014	970

UL/CSA Motor nominal current: single and three phase (according to UL 60947-4-1A)										
Motor power	120 V 1-ph	200 V 1-ph	200 V 3-ph	208 V 1-ph	208 V 3-ph	220-240 V 1-ph	220-240 V 3-ph	380-415 V 3-ph	440-480 V 3-ph	550-600 V 3-ph
hp	A	A	A	A	A	A	A	A	A	A
1/10	3	-	-	-	-	1.5	-	-	-	-
1/8	3.8	-	-	-	-	1.9	-	-	-	-
1/6	4.4	2.5	-	2.4	-	2.2	-	-	-	-
1/4	5.8	3.3	-	3.2	-	2.9	-	-	-	-
1/3	7.2	4.1	-	4	-	3.6	-	-	-	-
1/2	9.8	5.6	2.5	5.4	2.4	4.9	2.2	1.3	1.1	0.9
3/4	13.8	7.9	3.7	7.6	3.5	6.9	3.2	1.8	1.6	1.3
1	16	9.2	4.8	8.8	4.6	8	4.2	2.3	2.1	1.7
1-1/2	20	11.5	6.9	11	6.6	10	6	3.3	3	2.4
2	24	13.8	7.8	13.2	7.5	12	6.8	4.3	3.4	2.7
3	34	19.6	11	18.7	10.6	17	9.6	6.1	4.8	3.9
5	56	32.2	17.5	30.8	16.7	28	15.2	9.7	7.6	6.1
7-1/2	80	46	25.3	44	24.2	40	22	14	11	9
10	100	57.5	32.2	55	30.8	50	28	18	14	11
15	135	-	48.3	-	46.2	68	42	27	21	17
20	-	-	62.1	-	59.4	88	54	34	27	22
25	-	-	78.2	-	74.8	110	68	44	34	27
30	-	-	92	-	88	136	80	51	40	32
40	-	-	120	-	114	176	104	66	52	41
50	-	-	150	-	143	216	130	83	65	52
60	-	-	177	-	169	-	154	103	77	62
75	-	-	221	-	211	-	192	128	96	77
100	-	-	285	-	273	-	248	165	124	99
125	-	-	359	-	343	-	312	208	156	125
150	-	-	414	-	396	-	360	240	180	144
200	-	-	552	-	528	-	480	320	240	192
250	-	-	-	-	-	-	604	403	302	242
300	-	-	-	-	-	-	722	482	361	289
350	-	-	-	-	-	-	828	560	414	336
400	-	-	-	-	-	-	954	636	477	382
450	-	-	-	-	-	-	1030	-	515	412
500	-	-	-	-	-	-	1180	786	590	472

MANUAL MOTOR STARTER GUIDE

Nominal efficiency limits defined in IEC 60034-30-1:2014 (reference values at 50 Hz, based on test methods specified in IEC 60034-2-1:2014).

Out-put kW	IE1 Standard efficiency				IE2 High efficiency				IE3 Premium efficiency				IE4 Super Premium efficiency			
	2 pole	4 pole	6 pole	8 pole	2 pole	4 pole	6 pole	8 pole	2 pole	4 pole	6 pole	8 pole	2 pole	4 pole	6 pole	8 pole
0.12	45.0	50.0	38.3	31.0	53.6	59.1	50.6	39.8	60.8	64.8	57.7	50.7	66.5	69.8	64.9	62.3
0.18	52.8	57.0	45.5	38.0	60.4	64.7	56.6	45.9	65.9	69.9	63.9	58.7	70.8	74.7	70.1	67.2
0.20	54.6	58.5	47.6	39.7	61.9	65.9	58.2	47.4	67.2	71.1	65.4	60.6	71.9	75.8	71.4	68.4
0.25	58.2	61.5	52.1	43.4	64.8	68.5	61.6	50.6	69.7	73.5	68.6	64.1	74.3	77.9	74.1	70.8
0.37	63.9	66.0	59.7	49.7	69.5	72.7	67.6	56.1	73.8	77.3	73.5	69.3	78.1	81.1	78.0	74.3
0.40	64.9	66.8	61.1	50.9	70.4	73.5	68.8	57.2	74.6	78.0	74.4	70.1	78.9	81.7	78.7	74.9
0.55	69.0	70.0	65.8	56.1	74.1	77.1	73.1	61.7	77.8	80.8	77.2	73.0	81.5	83.9	80.9	77.0
0.75	72.1	72.1	70.0	61.2	77.4	79.6	75.9	66.2	80.7	82.5	78.9	75.0	83.5	85.7	82.7	78.4
1.1	75.0	75.0	72.9	66.5	79.6	81.4	78.1	70.8	82.7	84.1	81.0	77.7	85.2	87.2	84.5	80.8
1.5	77.2	77.2	75.2	70.2	81.3	82.8	79.8	74.1	84.2	85.3	82.5	79.7	86.5	88.2	85.9	82.6
2.2	79.7	79.7	77.7	74.2	83.2	84.3	81.8	77.6	85.9	86.7	84.3	81.9	88.0	89.5	87.4	84.5
3	81.5	81.5	79.7	77.0	84.6	85.5	83.3	80.0	87.1	87.7	85.6	83.5	89.1	90.4	88.6	85.9
4	83.1	83.1	81.4	79.2	85.8	86.6	84.6	81.9	88.1	88.6	86.8	84.8	90.0	91.1	89.5	87.1
5.5	84.7	84.7	93.1	81.4	87.0	87.7	86.0	83.8	89.2	89.6	88.0	86.2	90.9	91.9	90.5	88.3
7.5	86.0	86.0	84.7	83.1	88.1	88.7	87.2	85.3	90.1	90.4	89.1	87.3	91.7	92.6	91.3	89.3
11	87.6	87.6	86.4	85.0	89.4	89.8	88.7	86.9	91.2	91.4	90.3	88.6	92.6	93.3	92.3	90.4
15	88.7	88.7	87.7	86.2	90.3	90.6	89.7	88.0	91.9	92.1	91.2	89.6	93.3	93.9	92.9	91.2
18.5	89.3	89.3	88.6	86.9	90.9	91.2	90.4	88.6	92.4	92.6	91.7	90.1	93.7	94.2	93.4	91.7
22	89.9	89.9	89.2	87.4	91.3	91.6	90.9	89.1	92.7	93.0	92.2	90.6	94.0	94.5	93.7	92.1
30	90.7	90.7	90.2	88.3	92.0	92.3	91.7	89.8	93.3	93.6	92.9	91.3	94.5	94.9	94.2	92.7
37	91.2	91.2	90.8	88.8	92.5	92.7	92.2	90.3	93.7	93.9	93.3	91.8	94.8	95.2	94.5	93.1
45	91.7	91.7	91.4	89.2	92.9	93.1	92.7	90.7	94.0	94.2	93.7	92.2	95.0	95.4	94.8	93.4
55	92.1	92.1	91.9	89.7	93.2	93.5	93.1	91.0	94.3	94.6	94.1	92.5	95.3	95.7	95.1	93.7
75	92.7	92.7	92.6	90.3	93.8	94.0	93.7	91.6	94.7	95.0	94.6	93.1	95.6	96.0	95.4	94.2
90	93.0	93.0	92.9	90.7	94.1	94.2	94.0	91.9	95.0	95.2	94.9	93.4	95.8	96.1	95.6	94.4
110	93.3	93.3	93.3	91.1	94.3	94.5	94.3	92.3	95.2	95.4	95.1	93.7	96.0	96.3	95.8	94.7
132	93.5	93.5	93.5	91.5	94.6	94.7	94.6	92.6	95.4	95.6	95.4	94.0	96.2	96.4	96.0	94.9
160	93.8	93.8	93.8	91.9	94.8	94.9	94.8	93.0	95.6	95.8	95.6	94.3	96.3	96.6	96.2	95.1
200	94.0	94.0	94.0	92.5	95.0	95.1	95.0	93.5	95.8	96.0	95.8	94.6	96.5	96.7	96.3	95.4
250	94.0	94.0	94.0	92.5	95.0	95.1	95.0	93.5	95.8	96.0	95.8	94.6	96.5	96.7	96.5	95.4
315	94.0	94.0	94.0	92.5	95.0	95.1	95.0	93.5	95.8	96.0	95.8	94.6	96.5	96.7	96.6	95.4
355	94.0	94.0	94.0	92.5	95.0	95.1	95.0	93.5	95.8	96.0	95.8	94.6	96.5	96.7	96.6	95.4
400	94.0	94.0	94.0	92.5	95.0	95.1	95.0	93.5	95.8	96.0	95.8	94.6	96.5	96.7	96.6	95.4
450	94.0	94.0	94.0	92.5	95.0	95.1	95.0	93.5	95.8	96.0	95.8	94.6	96.5	96.7	96.6	95.4

**ABB STOTZ-KONTAKT GmbH**

Eppelheimer Straße 82  
69123 Heidelberg, Germany

Phone: +49 (0) 6221 701-0  
Fax: +49 (0) 6221 701-1325  
E-Mail: [info.desto@de.abb.com](mailto:info.desto@de.abb.com)

**You can find the address of your local sales organization on the ABB home page**



<http://www.abb.com/contacts> -> Low-voltage products

**Note**

We reserve the right to make technical changes or modify the contents of this document without prior notice. With regard to purchase orders, the agreed particulars shall prevail. ABB does not accept any responsibility whatsoever for potential errors or possible lack of information in this document.

**Exclusion of liability**

ABB is not responsible for the implementation, verification and validation of the overall safety system. It is the responsibility of the system integrator (or other party) who is responsible for the overall system and system safety. The system integrator (or other responsible party) must make sure that the entire implementation complies with all relevant standards, directives and local electrical code, and that the system is tested, verified and validated correctly.

We reserve all rights in this document and in the subject matter and illustrations contained therein. Any reproduction, disclosure to third parties or utilization of its contents - in whole or in parts - is forbidden without the prior written consent of ABB.

© Copyright 2018 ABB. All rights reserved. Specifications subject to change without notice.

