

# AMPROBE®

HARD AT WORK SINCE 1948.

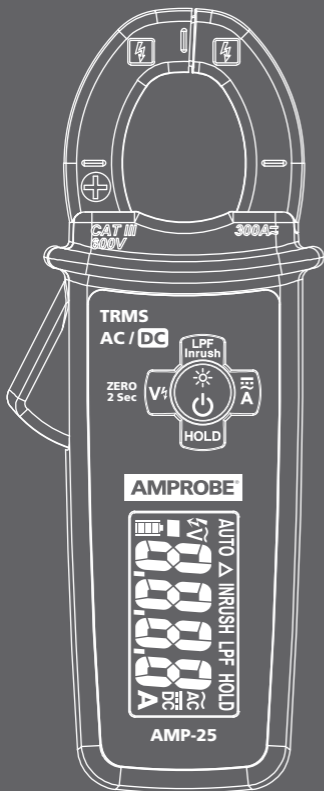

## AMP-25 AMP-25-EUR Mini-Clamp

## User Manual



**AMPROBE®**

**AMP-25**  
**AMP-25-EUR**  
**Mini-Clamp**

**User Manual**

**English**

## **Limited Warranty and Limitation of Liability**

Your Amprobe product will be free from defects in material and workmanship for one year from the date of purchase unless local laws require otherwise. This warranty does not cover fuses, disposable batteries or damage from accident, neglect, misuse, alteration, contamination, or abnormal conditions of operation or handling. Resellers are not authorized to extend any other warranty on the behalf of Amprobe. To obtain service during the warranty period, return the product with proof of purchase to an authorized Amprobe Service Center or to an Amprobe dealer or distributor. See Repair Section for details. THIS WARRANTY IS YOUR ONLY REMEDY. ALL OTHER WARRANTIES - WHETHER EXPRESS, IMPLIED OR STATUTORY - INCLUDING IMPLIED WARRANTIES OF FITNESS FOR A PARTICULAR PURPOSE OR MERCHANTABILITY, ARE HEREBY DISCLAIMED. MANUFACTURER SHALL NOT BE LIABLE FOR ANY SPECIAL, INDIRECT, INCIDENTAL OR CONSEQUENTIAL DAMAGES OR LOSSES, ARISING FROM ANY CAUSE OR THEORY. Since some states or countries do not allow the exclusion or limitation of an implied warranty or of incidental or consequential damages, this limitation of liability may not apply to you.

## **Repair**

All Amprobe returned for warranty or non-warranty repair or for calibration should be accompanied by the following: your name, company's name, address, telephone number, and proof of purchase. Additionally, please include a brief description of the problem or the service requested and include the test leads with the meter. Non-warranty repair or replacement charges should be remitted in the form of a check, a money order, credit card with expiration date, or a purchase order made payable to Amprobe.

## **In-warranty Repairs and Replacement – All Countries**

Please read the warranty statement and check your battery before requesting repair. During the warranty period, any defective test tool can be returned to your Amprobe distributor for an exchange for the same or like product. Please check the "Where to Buy" section on [www.Amprobe.com](http://www.Amprobe.com) for a list of distributors near you. Additionally, in the United States and Canada, in-warranty repair and replacement units can also be sent to an Amprobe Service Center (see address below).

## **Non-warranty Repairs and Replacement – United States and Canada**

Non-warranty repairs in the United States and Canada should be sent to an Amprobe Service Center. Call Amprobe or inquire at your point of purchase for current repair and replacement rates.

### **USA:**

Amprobe  
Everett, WA 98203  
Tel: 877-AMPROBE (267-7623)

### **Canada:**

Amprobe  
Mississauga, ON L4Z 1X9  
Tel: 905-890-7600

## **Non-warranty Repairs and Replacement – Europe**

European non-warranty units can be replaced by your Amprobe distributor for a nominal charge. Please check the "Where to Buy" section on [www.Amprobe.eu](http://www.Amprobe.eu) for a list of distributors near you.

### **Amprobe Europe\***

Beha-Amprobe  
In den Engematten 14  
79286 Glottertal, Germany  
Tel.: +49 (0) 7684 8009 - 0  
[www.Amprobe.eu](http://www.Amprobe.eu)

\*(Correspondence only – no repair or replacement available from this address. European customers please contact your distributor.)

# AMP-25 / AMP-25-EUR Mini-Clamp

---

## CONTENTS

SYMBOL.....	3
SAFETY INFORMATION .....	4
UNPACKING AND INSPECTION .....	6
MEASUREMENTS.....	6
Measuring AC and DC Current .....	8
DC A ZERO.....	9
Low Pass Filter.....	9
Inrush Current.....	9
Non-Contact Voltage Detection .....	10
Data Hold .....	11
Auto Power Off .....	11
SPECIFICATIONS.....	12
ELECTRICAL SPECIFICATIONS .....	14
MAINTENANCE AND REPAIR .....	15
BATTERY REPLACEMENT .....	16

## AMP-25 / AMP-25-EUR Mini-Clamp

---

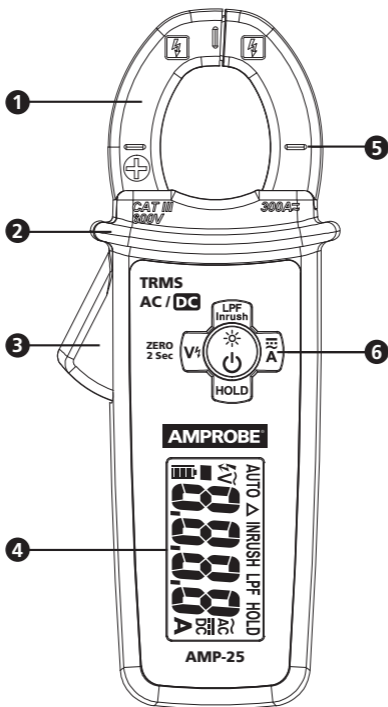

- ① Jaw
- ② Hand Guard
- ③ Jaw Trigger
- ④ LCD Display
- ⑤ Indicator of the Jaw Center for Current Measurement
- ⑥ Backlight / Flashlight & Function Buttons

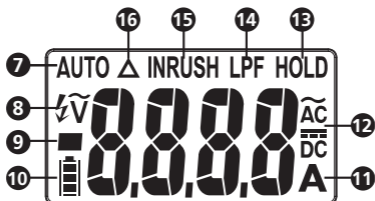

- ⑦ **AUTO:** Auto AC/DC current measurement mode active
- ⑧ ⚡V Non-Contact Voltage mode active
- ⑨ ■ Negative reading
- ⑩ Battery status indicator
- ⑪ **A:** Amps
- ⑫ Alternating Current (AC)  
 Direct Current (DC)
- ⑬ **HOLD:** Data hold
- ⑭ **LPF:** Low Pass Filter mode active
- ⑮ **INRUSH:** Inrush current mode active
- ⑯ Relative ZERO is active

## SYMBOLS

	Application and removal from hazardous live conductors permitted
	Caution! Risk of electric shock
	Caution! Refer to the explanation in this manual
	The equipment is protected by double insulation or reinforced insulation
	Earth (Ground)
<b>CAT III</b>	Overvoltage Category III
	Alternating Current (AC)

	Direct Current (DC)
	Battery
	Canadian Standards Association (NRTL/C)
	Complies with European Directives
	Conforms to relevant Australian standards
	Do not dispose this product as unsorted municipal waste. Contact a qualified recycler

## SAFETY INFORMATION

---

The Meter complies with:

- UL/IEC/EN 61010-1, CAN/CSA C22.2 No. 61010-1-12, Pollution Degree 2, Measurement Category III 600 V
- IEC/EN 61010-2-032, CAN/CSA-C22.2 No. 61010-2-032-12
- EMC IEC/EN 61326-1

**Measurement Category III (CAT III)** refers to measurements of hard-wired equipment in fixed installations, distribution boards, and circuit breakers. Also includes cables, bus bars, junction boxes, switches, socket outlets in the fixed installation, and stationary motors with permanent connections to fixed installations.

### CENELEC Directives

The instruments conform to CENELEC Low-voltage directive 2006/95/EC and Electromagnetic compatibility directive 2004/108/EC.

### **Warning: Read Before Using**

**To avoid possible electric shock or personal injury:**

- Use the Meter only as specified in this manual or the protection provided by the Meter might be impaired.
- Avoid working alone so assistance can be rendered.
- Do not use the Meter in wet or dirty environments.



- Do not use the Meter if it appears damaged. Inspect the Meter before use. Look for cracks or missing plastic. Pay particular attention to the insulation around the connectors.
- Have the Meter serviced only by qualified service personnel.
- Use extreme caution when working around bare conductors or bus bars. Contact with the conductor could result in electric shock.
- Do not hold the Meter anywhere beyond the tactile barrier.
- When measuring current, center the conductor in the clamp.
- Never operate the Meter with the battery cover removed or the case open.
- Never remove the battery cover or open the case of the Meter without first removing the jaws from a live conductor.
- Use caution when working with voltages above 30 V AC rms, 42 V AC peak, or 60 V DC. These voltages pose a shock hazard.
- Do not attempt to measure any voltage that might exceed the maximum range of the Meter.
- Use the proper function for your measurements.
- Do not operate the Meter around explosive gas, vapor, or dust.
- Use only 1.5 V LR44 batteries, properly installed in the Meter case, to power the Meter.
- To avoid false readings that can lead to electrical shock and injury, replace the battery as soon as the low battery indicator (  ) appears. Check Meter operation on a known source before and after use.
- When servicing, use only specified replacement parts.
- Adhere to local and national safety codes. Individual protective equipment must be used to prevent shock and arc blast injury where hazardous live conductors are exposed.

## UNPACKING AND INSPECTION

Your shipping carton should include:

- 1 Clamp meter
- 2 1.5 V LR44 batteries (installed)
- 1 Carrying case
- 1 User manual













If any of these items are damaged or missing, return the complete package to the place of purchase for an exchange.





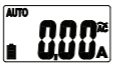

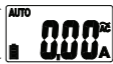
## MEASUREMENTS

### **Warning**

To avoid possible electric shock or personal injury:

- To avoid electric shock or personal injury:
- When measuring current, center the conductor in the clamp.
- Keep fingers behind Tactile Barrier.
- Use the proper function for measurements.

Button	Description
	<p>Press  button to turn ON the meter (the default is auto AC/DC A mode). Press &gt; one second to turn OFF.</p> <p> OFF</p> <p>Press     Press  &gt;1 Sec</p> <p>Press  button to turn ON or to turn OFF LCD backlight. The backlight automatically turns OFF after approximately 30 seconds.</p> <p> Press    </p>

	<p>Press  button to select AC A or DC A mode.</p> <p>Press  button &gt; one second to return to AUTO AC/DC A mode.</p>
<p><b>LPF Inrush</b></p>	<p>Press <b>LPF Inrush</b> button to enter Low Pass Filter mode (LPF is displayed). Press a second time to enter Inrush mode (INRUSH is displayed). Press again to exit the function.</p>
<p><b>V<sub>h</sub> / ZERO / 2 Sec</b></p>	<p>Press <b>V<sub>h</sub></b> button to activate non-contact voltage mode. Press a second time to exit non-contact voltage mode.</p> <p>Press <b>V<sub>h</sub> / ZERO / 2 Sec</b> button &gt; two seconds to clear DC A reading from the display (<math>\Delta</math> is displayed) and establish a baseline for DC A.</p> <p>Press <b>V<sub>h</sub></b> button &gt; two seconds again to exit this mode.</p> <p> <b>Caution</b></p> <ol style="list-style-type: none"> <li>1. ZERO mode can be activated in DC A and DC A of Auto DC/AC A mode only.</li> <li>2. When ZERO is activated (symbol <math>\Delta</math> is displayed in DC A and Auto DC A mode only), the offset residual value will not be reset until the Meter is turned OFF.</li> <li>3. ZERO can be activated if residual value &lt; 6 A in DC A mode, &lt; 6 A DC and &lt;0.1 A AC in Auto DC/AC A mode.</li> </ol>
<p><b>HOLD</b></p>	<p>Press <b>HOLD</b> button to freeze the display reading (<b>HOLD</b> is displayed) and releases the reading when pressed a second time.</p> <p>  <b>Warning</b></p> <p>To avoid possible electric shock or personal injury, when Display HOLD is activated, be aware that the display will not change when you apply a different current.</p>



## Measuring AC and DC Current

### **⚠️ ⚠️ Warning**

To avoid electrical shock and injury:

- Do not hold the Meter anywhere beyond the tactile barrier.
- Do not use the Meter to measure currents above the maximum rated frequency (400Hz). Circulating currents may cause the magnetic circuits of the Jaws reach hazardous excessive temperatures.

To measure AC or DC current:

1. Switch on the Meter by pressing  button, the default is auto AC/DC A detection mode (AUTO is displayed). Press  button to choose AC A or DC A. The display reflects the chosen function mode.
2. Open the clamp by pressing the jaw release and insert the conductor to be measured into the clamp. Ensure the jaws are firmly closed.
3. Close the clamp and center the conductor using the jaw alignment marks.
4. View the current reading on the display.

### **⚠️ Caution**

During current measurement keep the jaws away from other current carrying devices such as transformers, motors or energized wires, as they may negatively influence accuracy of the measurement.

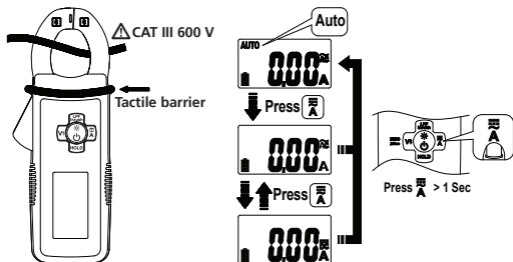

## DC A ZERO (DC A and Auto DC/AC A mode)

Press  $V\frac{1}{2}$  /  $\frac{ZERO}{2\text{Sec}}$  button > two second to clear DC A reading from the display and establish a baseline for DC A.

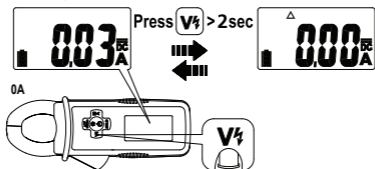

## Low Pass Filter

Press  $\frac{LPF}{Inrush}$  button to activate Low Pass Filter mode ("LPF" is displayed).

Press a second time, the Meter goes into Inrush mode (INRUSH is displayed). Press again to exit the function.

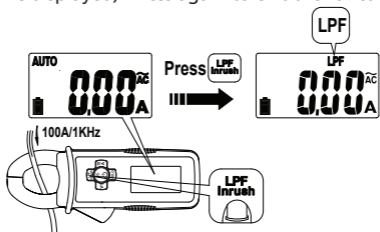

## Inrush Current

Press  $\frac{LPF}{Inrush}$  button to enter Low Pass Filter mode (LPF is displayed) first. Press a second time to enter Inrush mode ("INRUSH" is displayed). Press again to exit the function.

The Meter calculates the RMS value for 100ms when detecting a current above 5A.

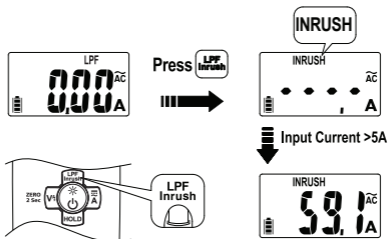

## Non-Contact Voltage Detection

1. Press **V<sub>⚡</sub>** button to activate non-contact voltage mode (**V<sub>⚡</sub>** is displayed).
2. The voltage detection antenna is located along the top end of the stationary clamp jaw for detecting electric field surrounding energized conductors
3. Detected electric field signal strength is indicated by a series of bar-graph segments on the display and beeper. The stronger the electric field detected, the more bar-graph segments are displayed and more intense beep-sound is generated.

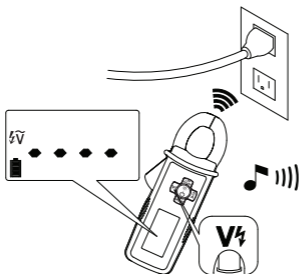

## Data Hold

Press **HOLD** button to freeze the display reading (HOLD is displayed) and releases the reading when pressed a second time.

### **Warning**

To avoid possible electric shock or personal injury, when Display HOLD is activated, be aware that the display will not change when you apply a different current.

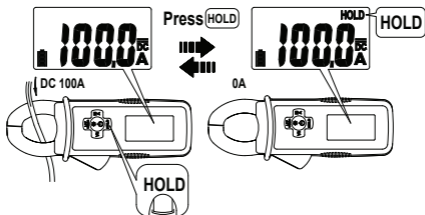

**Note:** During data hold, the display flashes if the measured signal is 50 counts larger than the display reading. The Meter cannot detect across the AC and DC current.

## Auto Power Off

The Meter turns off if there is no button pushed operation for 20 minutes.

To turn the Meter back on, press  button and release to restart the Meter. The Meter goes into default mode (auto AC/DC A) when the Meter is turned back ON.

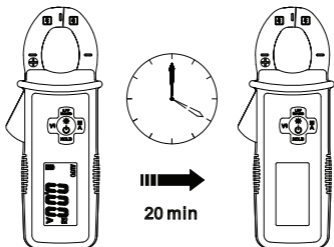

### Disable auto power off:

Press and hold **V $\frac{1}{2}$**  button while pressing  button.

**"AoFF"** is displayed, then release **V $\frac{1}{2}$**  and  button. The meter is turned ON and goes into default measurement function (auto AC/DC A).

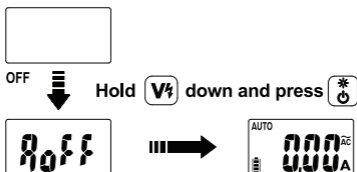





The auto power off mode resumes back when the Meter is OFF and is turned ON again.

## SPECIFICATIONS

Display	6000 counts
Sensing	True-RMS
Polarity	Automatic
Over-Range Display	"OL" or "-OL"
Update Rate	2 times per second nominal
Operating Temperature	32 °F to 122 °F (0 °C to 50 °C)
Relative Humidity	Non-condensing, 32 °F to 86 °F (0 °C to 30 °C) ≤ 80%, >86 °F to 104 °F (>30 °C to 40 °C) ≤ 75%, >104 °F to 122 °F (>40 °C to 50 °C) ≤ 45%
Storage Temperature	-4 °F to 140 °F (-20 °C to 60 °C), 0% to 80% R.H. (with battery removed)



<b>Pollution Degree</b>	2
<b>Operating Altitude</b>	≤ 2000 m
<b>Temperature Coefficient</b>	nominal 0.2 x (specified accuracy)/ °C , <18°C, >28°C)
<b>Transient Protection</b>	6.0 kV (1.2/50 μs surge)
<b>E.M.C.</b>	Meets IEC/EN 61326-1
<b>Safety Compliance</b>	IEC/EN 61010-1, IEC/EN 61010-2-032
<b>Agency Approval</b>	  
<b>Shock Vibration</b>	MIL-PRF-28800F for A class 2 instrument
<b>Drop-Proof</b>	4 feet (120 cm)
<b>Power Supply</b>	Two 1.5V LR44 size battery
<b>Battery Life</b>	20 hours
<b>Low Battery Indication</b>	
<b>Auto Power Off</b>	Idle for 20 minutes
<b>Dimension (L x W x H)</b>	5.8 x 2.4x 1.3 in (147 x 60 x 32 mm)
<b>Weight</b>	140 g (0.31 lb)
<b>Jaw Opening &amp; Conductor Diameter</b>	0.98 in (25 mm) max.

## ELECTRICAL SPECIFICATIONS

Accuracy is given as  $\pm$ (% of reading + counts of least significant digit) at  $23^{\circ}\text{C} \pm 5^{\circ}\text{C}$ , with relative humidity less than 80% R.H., AC A specifications are ac coupled, true R.M.S. The crest factor may be up to 3.0 as 4000 counts.

For non-sinusoidal waveforms, additional accuracy by Crest Factor (C.F.):

Add 3.0% for C.F. 1.0 ~ 2.0

Add 5.0% for C.F. 2.0 ~ 2.5

Add 7.0% for C.F. 2.5 ~ 3.0

Position Error of Clamp:  $\pm 1.5\%$  of display reading

### AC Current

<b>Range</b>	60.00 A	300.0 A
<b>Resolution</b>	0.01 A	0.1 A
<b>Accuracy 50 Hz to 100 Hz</b>	$\pm (1.5 \% + 25 \text{ LSD})$ at $< 3 \text{ A}$ $\pm (1.5 \% + 5 \text{ LSD})$ at $\geq 3 \text{ A}$	$\pm (1.5 \% + 5 \text{ LSD})$
<b>Accuracy 100 Hz to 400 Hz</b>	$\pm (2.5 \% + 25 \text{ LSD})$ at $< 3 \text{ A}$ $\pm (2.5 \% + 5 \text{ LSD})$ at $\geq 3 \text{ A}$	$\pm (2.5 \% + 5 \text{ LSD})$

Frequency Response: 50 to 400Hz (Sine Wave)

### DC Current

<b>Range</b>	60.00 A <sup>1)</sup>	300.0 A
<b>Resolution</b>	0.01 A	0.1 A
<b>Accuracy</b>	$\pm (1.5 \% + 10 \text{ LSD})$ <sup>2)</sup>	$\pm (1.5 \% + 5 \text{ LSD})$

<sup>1)</sup> There are less than 0.3A variations as measuring in different directions.

<sup>2)</sup> Add 10 LSD to accuracy in Auto AC / DC A mode.

## Low Pass Filter

<b>Range</b>	60.00 A	300.0 A
<b>Resolution</b>	0.01 A	0.1 A
<b>Accuracy 50 Hz to 60 Hz</b>	$\pm (3.5 \% + 25 \text{ LSD})$ at $< 3 \text{ A}$ $\pm (3.5 \% + 5 \text{ LSD})$ at $\geq 3 \text{ A}$	$\pm (3.5 \% + 5 \text{ LSD})$

Cut-off Frequency (-3dB): Approx. 160 Hz

Attenuation Characteristic: Approx. -24 dB/Octave

## Inrush Current

<b>Range</b>	300.0 A
<b>Resolution</b>	0.1 A

Integration Time: 100 ms

Trigger Current: 5.0 A

## Non-Contact Voltage Detection

Voltage range: 80 V to 600 V, 50 Hz to 60 Hz

Indication: bar-graph segments and audible beep tones proportional to the field strength

Detection frequency: 50/60 Hz

Detection antenna: inside the top side of the stationary jaw

## MAINTENANCE AND REPAIR

---

If the Meter fails to operate, check battery, test leads, etc., and replace as necessary.

Double check the following:

1. Replace the fuse or battery if the meter does not work.
2. Review the operating instructions for possible mistakes in operating procedure.

Except for the replacement of the battery, repair of the meter should be performed only by a Factory Authorized Service Center or by other qualified instrument service personnel.

The front panel and case can be cleaned with a mild solution of detergent and water. Apply sparingly with a soft cloth and allow to dry completely before using. Do not use aromatic hydrocarbons, gasoline or chlorinated solvents for cleaning.

## **BATTERY REPLACEMENT**

---

When battery voltage drops below the value required for proper operation, the battery symbol (  ) appears.

### **Warning**

**To avoid shock, injury, or damage to the Meter, disconnect test leads before opening case.**

### **Replacing BATTERY follow below steps:**

1. Remove the Meter from measuring circuit.
2. Turn the Meter to OFF position.
3. Remove the screw from the battery cover and open the battery cover
4. Remove the batteries and replace with two 1.5 V batteries (LR44). Observe correct polarity when installing the batteries.
5. Put the battery cover back and re-fasten the screw.  
Battery: 2 x 1.5 V (LR44)

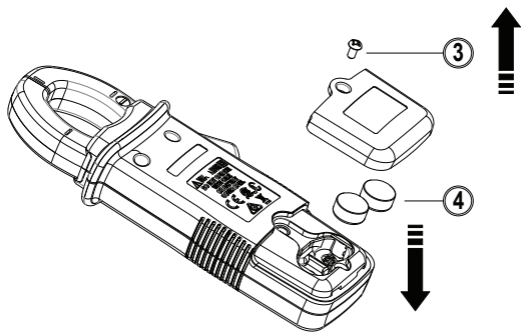

**Visit [www.Amprobe.com](http://www.Amprobe.com) for**

- **Catalog**
- **Application notes**
- **Product specifications**
- **User manuals**

**Amprobe®**

[www.Amprobe.com](http://www.Amprobe.com)

[info@amprobe.com](mailto:info@amprobe.com)

Everett, WA 98203

Tel: 877-AMPROBE (267-7623)

**Amprobe® Europe**

Beha-Amprobe

In den Engematten 14

79286 Glottertal, Germany

Tel.: +49 (0) 7684 8009 - 0

[www.beha-amprobe.com](http://www.beha-amprobe.com)



Please  
Recycle