



# FRITZ!Repeater 600

**Configuration and Operation**

# Table of Contents

<b>General Remarks</b> .....	4
Safety Instructions .....	5
Instructions and Help .....	7
Device Data on the Type Label .....	9
Package Contents .....	10
<b>Functions and Structure</b> .....	11
Functions .....	12
Button.....	13
LED .....	14
Requirements for Operation .....	16
<b>Connecting</b> .....	17
Connecting to FRITZ!Box.....	18
Connecting to Another Router.....	20
Finding the Ideal Location for FRITZ!Repeater.....	23
<b>Mesh</b> .....	25
Mesh of the FRITZ!Box.....	26
Enabling Mesh for FRITZ!Repeater.....	27
Connecting FRITZ!Repeater with Another Mesh Repeater.....	28
<b>Connecting Devices with FRITZ!Repeater</b> .....	30
Connecting Devices with the Wireless Radio Network .....	31
<b>User Interface</b> .....	33
Opening the User Interface.....	34
Configuring AVM Services for Diagnostics and Maintenance .....	39
<b>User Interface: Access to Home Network Menu</b> .....	41
Access to Home Network Menu: Settings and Features.....	42
Adopting Wireless LAN Settings from the Router (FRITZ!Box).....	43

**User Interface: Network** ..... 45

- The Network Menu: Settings and Features..... 46
- Configuring the IP Address Manually..... 47

**User Interface: Wireless Menu** ..... 48

- Wireless Menu: Settings and Features..... 49
- Configuring a Schedule for the Wireless Radio Network ..... 50
- Changing the Name of the Wireless Network (SSID) ..... 51
- Configuring Wireless Guest Access ..... 52

**User Interface: System Menu** ..... 53

- System Menu: Settings and Features..... 54
- Configuring Push Services ..... 55
- Switching LED On and Off..... 57
- Configuring a FRITZ!Repeater Password ..... 58
- Saving Settings ..... 60
- Loading Settings ..... 61
- Updating FRITZ!OS ..... 62
- Restoring Factory Settings ..... 63

**Malfunctions** ..... 64

- Troubleshooting Procedures..... 65

**Appendix**..... 68

- Technical Specifications..... 69
- Legal..... 71
- Information on Cleaning..... 75
- Disposal ..... 76

**Index**..... 77

# General Remarks

Safety Instructions .....	5
Instructions and Help .....	7
Device Data on the Type Label .....	9
Package Contents .....	10

## Safety Instructions

### Overview

Before connecting the FRITZ!Repeater, observe the following security instructions in order to protect yourself, the surroundings, and the FRITZ!Repeater from harm.

### Easy Accessibility

It must always be possible to disconnect the FRITZ!Repeater from electrical power.

- Insert the FRITZ!Repeater into an electrical outlet that is easy to reach.

### Overheating

Heat accumulation can lead to overheating of the FRITZ!Repeater and subsequently damage the FRITZ!Repeater.

- Install the FRITZ!Repeater in a place that is protected from direct sunlight.
- Provide for sufficient air circulation around the FRITZ!Repeater.
- Make sure that the ventilation slits on the housing are always unobstructed.
- Do not cover the FRITZ!Repeater.
- Avoid operation in the direct vicinity of a radiator or heating unit.

### Moisture, Liquids and Vapors

Moisture, liquids and vapors that find their way into the FRITZ!Repeater can cause electric shocks or short circuits.

- Only use the FRITZ!Repeater indoors.
- Never let liquids get inside the FRITZ!Repeater.
- Protect the FRITZ!Repeater from vapors and moisture.

### Improper Cleaning

Improper cleaning with strong detergents, solvents or wet cloths can cause damage to the FRITZ!Repeater.

- Please refer to the information about cleaning; [see page 75](#).

### Improper Opening and Repairs

Improper opening and improper repairs can present a hazard to users of the FRITZ!Repeater.

- Do not open the FRITZ!Repeater.

### Power Surges Caused by Lightning

During electrical storms, electrical surges caused by lightning present a danger to connected electrical devices.

- Do not install the FRITZ!Repeater during an electrical storm.
- During a storm, disconnect the FRITZ!Repeater from the power supply.

## Instructions and Help



### Instructions and Help

To connect, configure and operate your FRITZ!Repeater 600, use the following instructions and help:

Instructions, Help	Contents	Location
Manual	Status: current version of FRITZ!OS	<a href="http://en.avm.de/service/manuals">en.avm.de/service/manuals</a>
	Connecting, configuration and operation	
	Range of functions of your FRITZ! device	
Quick guide	Connecting and configuration	Is provided in print with your FRITZ!Repeater
Online help	Instructions on configuration and operation	<a href="http://fritz.repeater/">http://fritz.repeater /</a> 
Knowledge Base	Solutions for common problems during connection, configuration and operation	<a href="http://en.avm.de/service">en.avm.de/service</a>
Newsletter and social media	The latest information on FRITZ! products, updates, and practical tips	<a href="http://en.avm.de/newsletter">en.avm.de/newsletter</a>
		<a href="#">Facebook</a>
		<a href="#">Instagram</a>
		<a href="#">Twitter</a>
		<a href="#">YouTube</a>

## Symbols Used

The following symbols are used in this manual:

Symbol	Meaning
	Important message that should be complied with in order to prevent material damage, errors or malfunctions
	Useful tip for configuring and operating the FRITZ!Repeater



## Device Data on the Type Label

### Overview

Important device data on your FRITZ!Repeater device are presented on the type label on the Back of the Device.

### Device Data on the Type Label

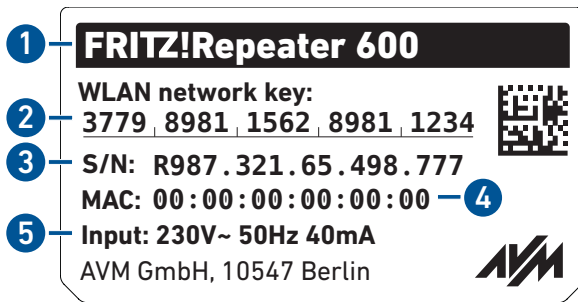

No.	Meaning
1	Product name
2	Network key (wireless LAN password)
3	Serial number
4	MAC address of the FRITZ!Repeater 600
5	Power adapter specification

## Package Contents

### Package Contents

Number	Supplied Part
1	FRITZ!Repeater 600
1	CEE 7/4 (Schuko) adapter (installed)
1	Quick guide

### CEE 7/4 (Schuko) adapter

To stabilize the FRITZ!Repeater in CEE 7/4 (Schuko) outlets, a Schuko adapter ring is premounted on the plug. If this adapter is not needed, it can be removed.

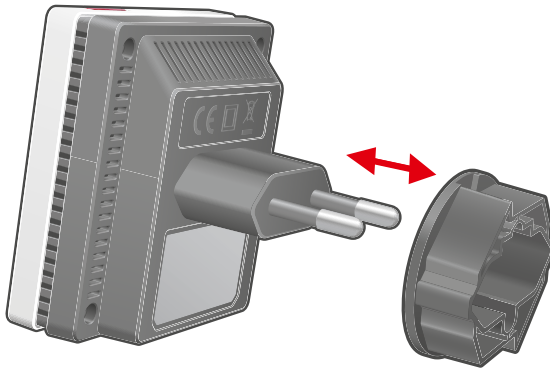

# Functions and Structure

Functions .....	12
Button.....	13
LED .....	14
Requirements for Operation .....	16

## Functions

### Extending Wireless LAN

The wireless radio network of an internet router (FRITZ!Box) often does not cover all rooms in an apartment or a house. With FRITZ!Repeater 600 wireless devices like computers, tablets and smartphones get a connection to the internet router even where its wireless radio network is poor or cannot be received at all. For this the FRITZ!Repeater expands the wireless radio network of the internet router (FRITZ!Box).

# Button

## Button Functions

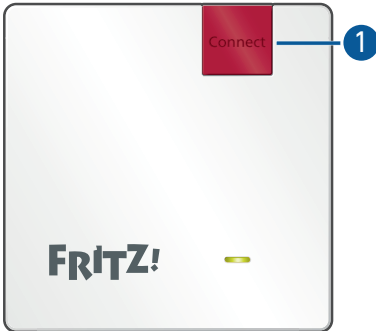



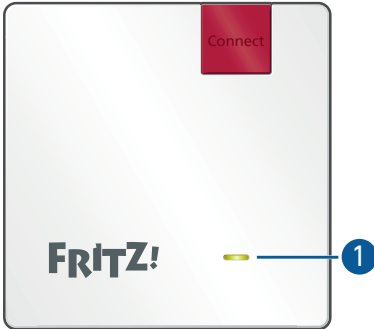

No.	Button	Press	Function
1	Connect	for 1 second	<ul style="list-style-type: none"> <li>Establishes a connection (starts WPS)</li> <li>Enables Mesh</li> </ul>
		6 seconds	Connects with another wireless access point
		at least 15 seconds	Loads factory settings

# LED

## Meaning of the LED



No.	LED	Condition	Meaning
1		glows green	FRITZ!Repeater ready for operation, good wireless connection to a router/repeater
		flashes green	slowly (every 2 seconds) <ul style="list-style-type: none"> <li>FRITZ!Repeater ready to configure a connection</li> </ul> fast (twice per second) <ul style="list-style-type: none"> <li>FRITZ!Repeater starting</li> <li>Registering with router</li> <li>Performing WPS</li> <li>Enabling Mesh</li> <li>FRITZ!OS update in progress</li> <li>Loading factory settings</li> </ul>
		glows orange	Weak wireless connection to a router/repeater

No.	LED	Condition	Meaning
1		flashes orange	No connection to router/repeater
		off	<ul style="list-style-type: none"> <li>No electrical power</li> <li>Wireless switching schedule enabled</li> </ul>

## Requirements for Operation

### Requirements

In order to operate the FRITZ!Repeater 600, you must have the following:

- FRITZ!Box or other wireless router compliant with IEEE 802.11n, 802.11g or 802.11b in the 2.4-GHz frequency band
- Router with automatic IP address assignment (DHCP)
- For Mesh: FRITZ!Box with FRITZ!OS 7.00 or higher



# Connecting

Connecting to FRITZ!Box..... 18  
Connecting to Another Router ..... 20  
Finding the Ideal Location for FRITZ!Repeater..... 23



## Connecting to FRITZ!Box



### Overview

Connect the FRITZ!Repeater to your FRITZ!Box as described below.

### Requirements

- If the FRITZ!Repeater has already been in use: The factory settings have been restored to the FRITZ!Repeater; [see page 63](#).

### Instructions: Establishing a Wireless Connection to the FRITZ!Box

1. Connect the FRITZ!Repeater to an electrical outlet in the vicinity of the FRITZ!Box.
2. Wait until the  LED starts flashing slowly.
3. Press the "Connect" key.  
The  LED flashes faster.
4. Start WPS on the FRITZ!Box. The procedure depends on the buttons on the FRITZ!Box:

FRITZ!Box with Button	Start WPS
"WPS" or "Connect/WPS"	Press button briefly.
"WLAN" or "WLAN / WPS"	Press and hold the button down for at least 6 seconds.

5. Wait until the  LED on the FRITZ!Repeater lights up.  
The wireless connection to the FRITZ!Box is established.

6. Insert the FRITZ!Repeater into an electrical outlet where the wireless radio network is to be expanded. The distance from the FRITZ!Box should be about the same as the distance from the wireless devices for which the radio network is being expanded. The FRITZ!Repeater starts and reconnects to the FRITZ!Box (LED flashes). A steady green LED indicates that the connection has been established.
7. A green LED indicates that the FRITZ!Repeater is positioned in a good location.  
If the LED is orange or flashing orange, then the wireless connection to the FRITZ!Box is weak or could not be established. Test other outlets; see [Finding the Ideal Location for FRITZ!Repeater, page 23](#).

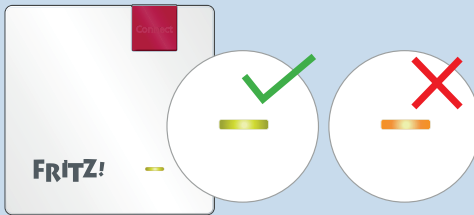

## Connecting to Another Router

### Overview

Connect the FRITZ!Repeater as described below if your router is not a FRITZ!Box.

You can establish the wireless connection via WPS. If the router does not support WPS, you can use a wizard.



### Requirements

- If the FRITZ!Repeater has already been in use: The factory settings have been restored to the FRITZ!Repeater; [see page 63](#).
- For wireless connections using WPS: The router must support WPS and WPS must be enabled.

### Rules

- When establishing a wireless connection, the FRITZ!Repeater adopts the following wireless LAN settings from the router: wireless network name/SSID, network key, and channel settings. If you change these settings in the router, you have to adopt the wireless settings for the repeater again; [see page 43](#).

### Instructions: Establishing a Wireless Connection to the Router with WPS

1. Connect the FRITZ!Repeater to an electrical outlet in the vicinity of the router.
2. Wait until the  LED starts flashing slowly.
3. Press the "Connect" key.  
The  LED flashes faster.
4. Start WPS on the router. See the documentation of the router for instructions.
5. Wait until the  LED on the FRITZ!Repeater lights up.  
The wireless connection to the FRITZ!Box is established.

6. Insert the FRITZ!Repeater into an electrical outlet where the wireless radio network is to be expanded.

The distance from the wireless router should be about the same as the distance from the wireless devices for which the radio network is being expanded.

The FRITZ!Repeater starts and reconnects to the FRITZ!Box (LED flashes). A steady green LED indicates that the connection has been established.

7. A green LED indicates that the FRITZ!Repeater is positioned in a good location.

If the LED is orange or flashing orange, then the wireless connection to the wireless router is weak or could not be established. Test other outlets; see [Finding the Ideal Location for FRITZ!Repeater, page 23](#).

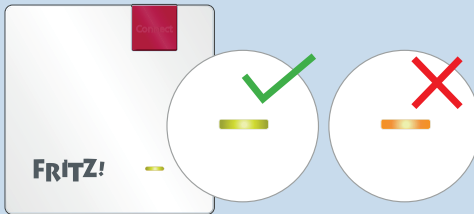

### Instructions: Establishing a Wireless Connection to the Router with a Wizard

1. Connect the FRITZ!Repeater to an electrical outlet in the vicinity of the router.
2. Wait until the  LED starts flashing slowly.
3. Connect the FRITZ!Repeater to a computer using a LAN cable, or establish a wireless connection to the FRITZ!Repeater on a computer, tablet or smartphone.

The preset network key of the FRITZ!Repeater is located on the Back of the Device.

4. Enter the address <http://fritz.repeater> in a web browser on a computer.

The user interface of the FRITZ!Repeater appears.

5. Enter a password for the user interface.  
We recommend leaving the AVM services for diagnostics and maintenance of the FRITZ!Repeater enabled. You can change this setting at any time.
6. Click on “OK”.
7. Enable the connection type “Wireless bridge” and click on “Next”.
8. Select the radio network of your router and click on “Next”.
9. Enter your network key for the router’s wireless network, and click on “Next” and then on “Finish”.
10. Wait until the  LED on the FRITZ!Repeater lights up.  
The wireless connection to the FRITZ!Box is established.
11. Insert the FRITZ!Repeater into an electrical outlet where the wireless radio network is to be expanded.  
The distance from the wireless router should be about the same as the distance from the wireless devices for which the radio network is being expanded.  
The FRITZ!Repeater starts and reconnects to the FRITZ!Box (LED flashes). A steady green LED indicates that the connection has been established.
12. A green LED indicates that the FRITZ!Repeater is positioned in a good location.  
If the LED is orange or flashing orange, then the wireless connection to the wireless router is weak or could not be established. Test other outlets; [see Finding the Ideal Location for FRITZ!Repeater, page 23](#).

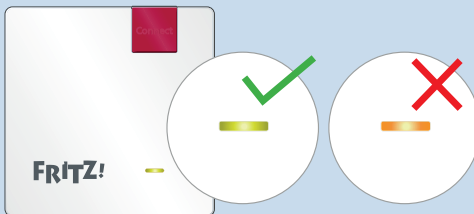

## Finding the Ideal Location for FRITZ!Repeater

### Overview

The position for the FRITZ!Repeater that optimizes expansion of the wireless radio network can be found by applying the following rules. In combination with a FRITZ!Box you can also use the FRITZ!App WLAN.

### Rules

- Space should be left between the FRITZ!Repeater and walls, radiators, large devices with metal housings, other wireless devices, and transmitting devices like baby monitors, microwaves and DECT base stations.
- The router's wireless LAN should be available in high quality. The  LED should be green.
- The FRITZ!Repeater should not be located too close to the router. With no obstructions between the devices, the distance should not be much less than 3 meters.

### FRITZ!App WLAN

FRITZ!App WLAN includes a feature to evaluate the position of the FRITZ!Repeater. This feature assists you in finding the best location for the FRITZ!Repeater.

You can download FRITZ!App WLAN for free:

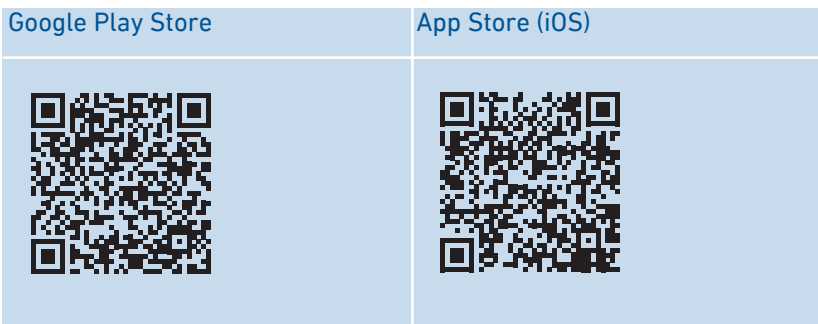

## Instructions: Positioning FRITZ!Repeater with FRITZ!App WLAN

1. Start the FRITZ!App WLAN.
2. In Android: Tap on the  menu and select "Repeater".  
In iOS: Tap the "My Repeater Position" button.
3. Tap on "Evaluate Repeater Position".  
If the FRITZ!Repeater is not in an optimum position, you will receive tips for improving the range of the wireless network.



# Mesh

Mesh of the FRITZ!Box ..... 26

Enabling Mesh for FRITZ!Repeater..... 27

Connecting FRITZ!Repeater with Another Mesh Repeater ..... 28

---

## Mesh of the FRITZ!Box

### Overview

Mesh connects the wireless networks of your FRITZ! devices to form a combined wireless network. Your FRITZ!Box is the hub of the Mesh.

### Requirements

- FRITZ!Box with FRITZ!OS 7.00 or newer.

### Features in the Mesh

- The FRITZ!Repeater adopts from the FRITZ!Box: wireless network name (SSID), wireless network key, wireless guest access and wireless switching schedule. Changes in the FRITZ!Box are automatically applied to the FRITZ!Repeater.
- Faster wireless connections: As Mesh Master, the FRITZ!Box uses AP steering to ensure that wireless devices in the Mesh always connect with the home network via the best access point.
- Updates for the FRITZ!Repeater and other FRITZ! devices in the Mesh can be performed centrally in the user interface of the FRITZ!Box.
- The “Mesh Overview” in the user interface of the FRITZ!Box shows which devices are connected with the FRITZ!Repeater.
- You can connect multiple Mesh Repeaters with each other (in series) to extend the range of the radio network in a certain direction.

## Enabling Mesh for FRITZ!Repeater

### Overview

After connecting to the FRITZ!Box, check whether Mesh is enabled for the FRITZ!Repeater. If Mesh is not enabled yet, enable Mesh now.

### Requirements

- FRITZ!Box with FRITZ!OS 7.00 or newer.

### Instructions: Enabling Mesh for the FRITZ!Repeater

1. Press the "Connect" button on the FRITZ!Repeater briefly.
2. Start WPS on the FRITZ!Box. The procedure depends on the buttons on the FRITZ!Box:

FRITZ!Box with Button	Start WPS
"WPS" or "Connect/WPS"	Press button briefly.
"WLAN" or "WLAN / WPS"	Press and hold the button down for at least 6 seconds.

## Connecting FRITZ!Repeater with Another Mesh Repeater



### Overview

In the Mesh of a FRITZ!Box you can connect several Mesh Repeaters in series. A Mesh Repeater can be a FRITZ!Repeater, a FRITZ!Powerline device, or a FRITZ!Box configured as a Mesh Repeater.

### Requirements

- Mesh is enabled for the FRITZ!Repeater.

### Instructions:

1. Connect the FRITZ!Repeater to an electrical outlet in the vicinity of the other Mesh Repeater.
2. Wait until the  LED starts flashing slowly.
3. Press the "Connect" key.  
The  LED flashes faster.
4. On the other Mesh Repeater: Start the connection procedure:

Mesh Repeater	Start Connecting
FRITZ!Box with "WLAN" or "WLAN/WPS" button	Press and hold the button down for at least 6 seconds.
Other FRITZ!Box	Press the "Connect/WPS" or "WPS" button briefly (for 1 second).
FRITZ!Repeater	Press the "Connect" or "WPS" button briefly (for 1 second).
FRITZ!Powerline	Press the "Connect" or "WLAN/WPS" button briefly (for 1 second).

5. Wait until the  LED on the FRITZ!Repeater lights up.  
The wireless connection to the FRITZ!Box is established.

6. Insert the FRITZ!Repeater into an electrical outlet where the wireless radio network is to be expanded.

The FRITZ!Repeater starts (LED lights up green) and connects to the other Mesh Repeater (LED flashes orange). The LED lights up once the connection has been established.

7. A green LED indicates that the FRITZ!Repeater is positioned in a good location.

If the LED is orange or flashing orange, then the wireless connection to the other Mesh Repeater is weak or could not be established. Test other outlets; see [Finding the Ideal Location for FRITZ!Repeater](#), page 23.

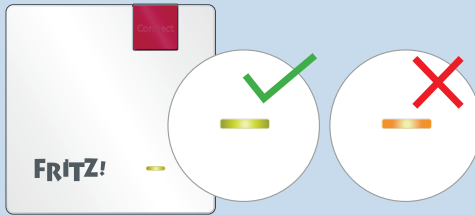

# Connecting Devices with FRITZ!Repeater

Connecting Devices with the Wireless Radio Network ..... 31

## Connecting Devices with the Wireless Radio Network

### Overview

Laptops, smartphones and other wireless devices can be connected with the wireless radio network of the FRITZ!Repeater in two ways: Via WPS or by entering the wireless network key.

WPS (Wi-Fi Protected Setup) is a feature with which you can establish secure wireless LAN connections quickly and securely at the touch of a button.

### Requirements

- For wireless connections with WPS: The wireless device supports WPS.

### Rules



- The following instructions assume that the FRITZ!Repeater adopted the wireless network name (SSID) and the wireless network key from the router (FRITZ!Box). If you configured other wireless LAN settings in the FRITZ!Repeater, then use the settings of the FRITZ!Repeater to establish wireless connections.

### Instructions: Connecting to an Android Device with WPS

All Android versions support WPS up to and including Android 8.0.

1. On the Android device: Search for WPS in the settings. You can find WPS by using the search function in the settings, or under "Wi-Fi / Advanced".
2. Start connecting with WPS. Use the push button method (also called "Press WPS Button", "PBC", or "Push Button Configuration").
3. On FRITZ!Repeater: Press the "Connect" button.  
The  LED starts to flash. The wireless connection has been established when the LED lights up.

## Instructions: Connecting with WPS in Windows 10

1. In Windows 10: Click with the right mouse button on the Windows icon .
2. Select "Settings".
3. Click on "Network and Internet".
4. Click on "Wi-Fi".
5. Click on "Show available networks".
6. Click on the name of the wireless radio network of your router (FRITZ!Box). If you configured a different wireless network name for the FRITZ!Repeater, then click on that name.  
The field for entering the network key appears, along with the indication that "You can also connect by pressing the button on the router". (If this message does not appear, the computer does not support WPS.)
7. On FRITZ!Repeater: Press the "Connect" button.  
The  LED starts to flash. The wireless connection has been established when the LED lights up.

## Instructions: Establishing a Wireless LAN Connection with a Network Key

1. Start the wireless LAN software on your wireless device and search for wireless radio networks.
2. Select the wireless radio network of your router (FRITZ!Box).
3. Start the connection procedure and enter the wireless network key of your router.



# User Interface

Opening the User Interface ..... 34

Configuring AVM Services for Diagnostics and Maintenance ..... 39



## Opening the User Interface

### Overview

Your FRITZ!Repeater has a user interface you can open in a web browser on your computer, tablet or smartphone. In the user interface you can configure your FRITZ!Repeater, enable or disable functions and receive information on connections and ports.

### AVM Services for Diagnostics and Maintenance

The first time the user interface is opened, you will be asked whether you consent to the use of AVM services for diagnostics and maintenance. We recommend leaving the use of AVM services enabled. You can change this setting at any time. For more information on AVM services, [see page 39](#).

## Areas of the User Interface

The screenshot shows the FRITZ!Repeater web interface. The top navigation bar includes the FRITZ! logo, the title 'FRITZ!Repeater', and an 'Overview' tab. A sidebar on the left contains menu items: Overview (1), Access to Home Network, Network, Wireless, System, and Wizards (5). The main content area displays system information (2) such as 'Model: FRITZ!Repeater' and 'Current power consumption: 96%', and connection details (4) including 'Type of Connection: Wireless Bridge', 'FRITZ!Box (router)', 'Encryption: WPA2', and a network diagram. Below this, there are sections for 'Interfaces' (6) and 'Network enabled: 5'. At the bottom left, there are links for 'Contents', 'Manual', and 'Legal Notices' (7).

No.	Display / Function
1	Menu
2	System information <ul style="list-style-type: none"> <li>Current power consumption</li> <li>FRITZ!OS installed</li> </ul>
3	Link to the online help
4	Type of connection (to the home network)
5	Configuration wizards
6	Connected devices and devices in the home network
7	Links <ul style="list-style-type: none"> <li>Contents: all pages in the user interface</li> <li>Manual: FRITZ!Repeater 600 (PDF)</li> <li>en.avm.de: AVM web pages</li> </ul>

## Instructions: Opening the User Interface (One FRITZ!Repeater)

If you are using only one FRITZ!Repeater with wireless LAN in the home network of your FRITZ!Box, open the user interface as follows:

1. Open a web browser on a computer, tablet or smartphone in the home network.
2. Enter the address <http://fritz.repeater>.

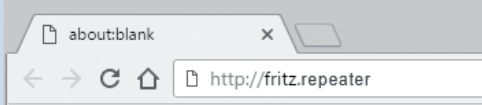

## Instructions: Opening the User Interface (Multiple FRITZ!Repeaters)

If you are using more than one FRITZ!Repeater with wireless LAN in the home network of your FRITZ!Box, open the user interface as follows:

1. Open a web browser on a computer, tablet or smartphone in the home network.
2. Enter the address <http://fritz.box>.
3. In the user interface of the FRITZ!Box, select "Home Network / Mesh Overview".
4. Click on the name of a FRITZ!Repeater (1) or enter its IP address (2) in the web browser.

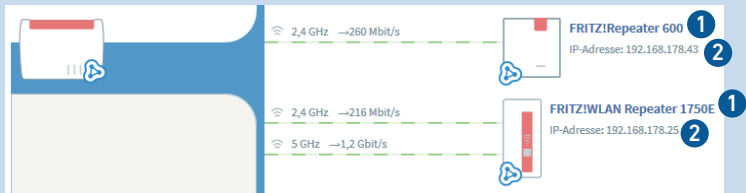

## Instructions: Opening the User Interface (Other Internet Router)

If your internet router is not a FRITZ!Box, open the user interface of the FRITZ!Repeater as follows:

1. Open the user interface of the internet router.
2. Check the IP address of FRITZ!Repeater 600.
3. Enter the IP address in a web browser on a computer, tablet or smartphone.

## Instructions: Opening the User Interface (No Connection to the Home Network)

If the FRITZ!Repeater is not integrated in the home network and does not have a connection to the internet router, then open the user interface as follows:

1. Plug the FRITZ!Repeater into an outlet.
2. Connect a computer to the FRITZ!Repeater via LAN cable, or establish a wireless connection to the FRITZ!Repeater on a computer, tablet or smartphone. The preset network key of the repeater is printed on the base of the device.
3. Open a web browser on your computer and enter the address <http://fritz.repeater> or [192.168.178.2](http://192.168.178.2).

## Configuring AVM Services for Diagnostics and Maintenance

### Overview

You can set up AVM services for diagnostics and maintenance. These services support the security and further development of your FRITZ!Repeater 600 and keep the FRITZ!OS up to date.

### AVM Services

AVM Service	Function
Search for updates	Your FRITZ!Repeater connects with the AVM update server regularly to search for and install FRITZ!OS updates.
Diagnostics data for error analysis	Your FRITZ!Repeater transmits error reports and technical diagnostics data to AVM upon suspicion of misuse by third parties.
Diagnostics data for system maintenance	In order to make the FRITZ!OS more secure and develop it further, the FRITZ!Repeater transmits device-specific data like FRITZ!Repeater model, FRITZ!OS version, basic settings and your network provider to AVM.

### Data Privacy

The diagnostics data and the device-specific data transmitted by your FRITZ!Repeater to AVM do not contain any personalized data. The data transmitted serve the exclusive purpose of technical adaptations and optimizations of your FRITZ!Repeater. The exact wording of the data privacy statement is presented under “Legal Notice / Data Privacy Statement” in the online help.

### Instructions: Configuring AVM Services

1. Open the user interface, [see page 34](#).

2. Select "Contents / AVM Services".
3. For instructions, open the online help .



## User Interface: Access to Home Network Menu

Access to Home Network Menu: Settings and Features .....	42
Adopting Wireless LAN Settings from the Router (FRITZ!Box) .....	43

## Access to Home Network Menu: Settings and Features

### Overview

In the “Access to Home Network” menu you receive an overview of how your FRITZ!Repeater is connected with the home network and the internet router (FRITZ!Box). You can start a WPS connection in order to adopt the radio network settings of the internet router automatically.

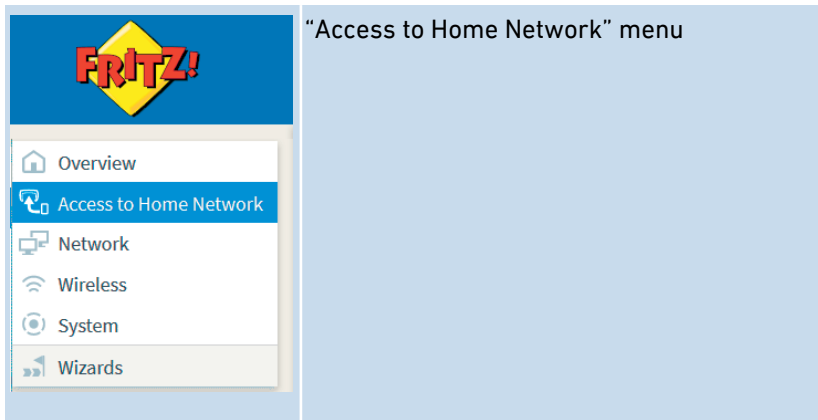

## Adopting Wireless LAN Settings from the Router (FRITZ!Box)

### Overview

You can adopt the wireless LAN settings of the router at the touch of a button. You only need this feature if your router is not a FRITZ!Box, or if your FRITZ!Box does not support Mesh.

In the Mesh of a FRITZ!Box, the FRITZ!Repeater automatically adopts the wireless LAN settings when it is connected, and every time they are changed in the FRITZ!Box; without Mesh, they are adopted only upon connection.

The wireless LAN settings adopted are the wireless network name (SSID), network key, channel settings, wireless guest access and wireless switching schedule.

### Example

Your router is not a FRITZ!Box and you changed the wireless network name (SSID) in the router. The FRITZ!Repeater is to adopt the change.

### Instructions: Adopting the Wireless LAN Settings of the Router at the Touch of a Button

1. Press the "Connect" button on the FRITZ!Repeater.  
The  LED flashes.
2. Start WPS on the router. The procedure depends on the router you are using:

Router	Start WPS
FRITZ!Box with "WPS" or "Connect/WPS" button	Press button briefly.

Router	Start WPS
FRITZ!Box with "WLAN" or "WLAN/WPS" button	Press and hold the button down for at least 6 seconds.
Other router	Instructions are provided by the manufacturer, for instance, in the router manual.

## User Interface: Network

The Network Menu: Settings and Features.....	46
Configuring the IP Address Manually.....	47

## The Network Menu: Settings and Features

### Overview

The “Network” menu presents you an overview of the network devices connected with the FRITZ!Repeater 600 in the network. You can also define an IP address for the FRITZ!Repeater manually.

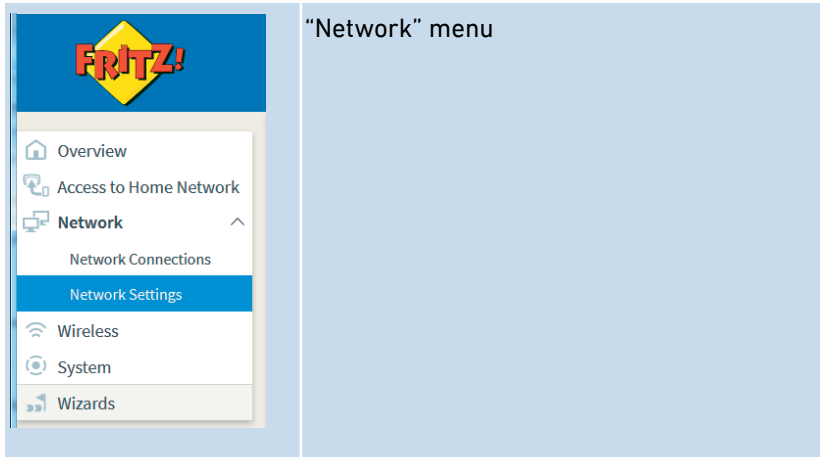

### Description of the Submenus

The online help of the user interface includes a detailed description of the submenus.

## Configuring the IP Address Manually

### Overview

In the default setting, the FRITZ!Repeater 600 automatically obtains an IP address from the router (FRITZ!Box). You can also define the IP address for the FRITZ!Repeater manually.

### Application Scenario

- FRITZ!Repeater 600 is to be used in a home network where there is no DHCP server to assign IP addresses automatically.

### Instructions: Configuring the IP Address Manually

1. Open the user interface, [see page 34](#).
2. Select "Network / Network Settings".
3. For instructions, open the online help .

## User Interface: Wireless Menu

Wireless Menu: Settings and Features.....	49
Configuring a Schedule for the Wireless Radio Network .....	50
Changing the Name of the Wireless Network (SSID) .....	51
Configuring Wireless Guest Access .....	52



## Wireless Menu: Settings and Features

### Overview

In the “Wireless” menu you can change the security settings of the wireless radio network. You can also configure a switching schedule and wireless guest access.

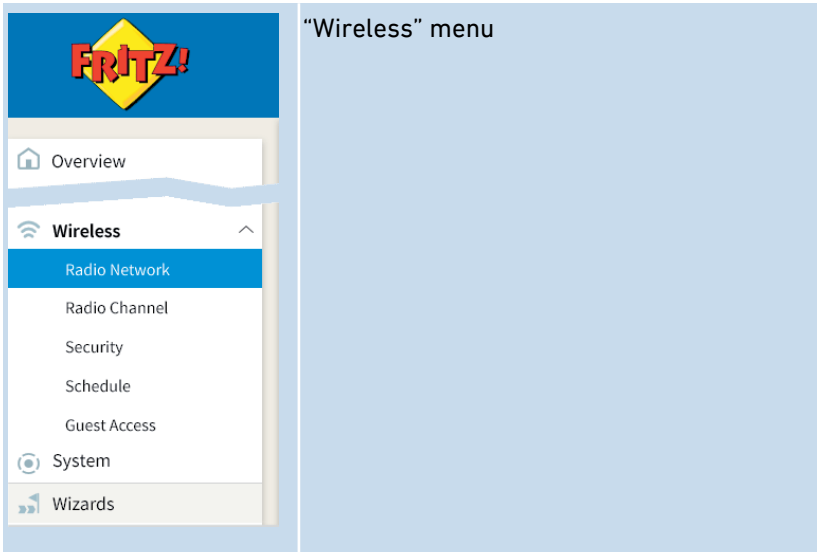

### Description of the Submenus

The online help of the user interface includes a detailed description of the submenus.

## Configuring a Schedule for the Wireless Radio Network

### Overview

If there are regular times when you do not use wireless LAN, you can set up a switching schedule for the wireless radio network. This way you reduce both power consumption and wireless radiation.

### Requirements

The following prerequisite must be met if the FRITZ!Repeater is located in the Mesh of a FRITZ!Box:

- Adoption of the FRITZ!Box settings is disabled in the “Access to Home Network” menu of the FRITZ!Repeater’s user interface.

### Instructions: Configuring a Schedule

1. Open the user interface, [see page 34](#).
2. Select “Wireless / Schedule”.
3. For instructions, open the online help .

## Changing the Name of the Wireless Network (SSID)

### Overview

You can change the name of the wireless network (SSID) of your FRITZ!Repeater.

### Example

The FRITZ!Repeater has the same SSID as your internet router (FRITZ!Box), but you would specifically like to select the wireless network of the FRITZ!Repeater on a wireless device.

### Instructions: Changing the Name of the Wireless Network (SSID)

1. Open the user interface, [see page 34](#).
2. Select "Wireless / Radio Network".
3. For instructions, open the online help .

## Configuring Wireless Guest Access

### Overview

If the FRITZ!Repeater is connected with a FRITZ!Box, you can set up a wireless guest access for your guests. With this your guests receive an internet connection of their own for their smartphones, tablets or laptops. Access to other devices in the home network (for instance, shared files, printers) is not possible from the guest network. No settings on the FRITZ!Box or FRITZ!Repeater can be changed via the guest access.

By default, FRITZ!Repeater makes available the guest access configured in the FRITZ!Box. You can also configure your own guest access for the repeater.

### Instructions: Configuring Wireless Guest Access

1. Open the user interface, [see page 34](#).
2. Select "Wireless / Guest Access".
3. For instructions, open the online help .

## User Interface: System Menu

System Menu: Settings and Features .....	54
Configuring Push Services .....	55
Switching LED On and Off.....	57
Configuring a FRITZ!Repeater Password .....	58
Saving Settings .....	60
Loading Settings .....	61
Updating FRITZ!OS .....	62
Restoring Factory Settings .....	63

## System Menu: Settings and Features

### Overview

The “System” menu presents information on operating of the FRITZ!Repeater. You can assign a device name and switch the LED on and off.

You can also change the password for the user interface, back up your settings, and specify how FRITZ!OS is updated.

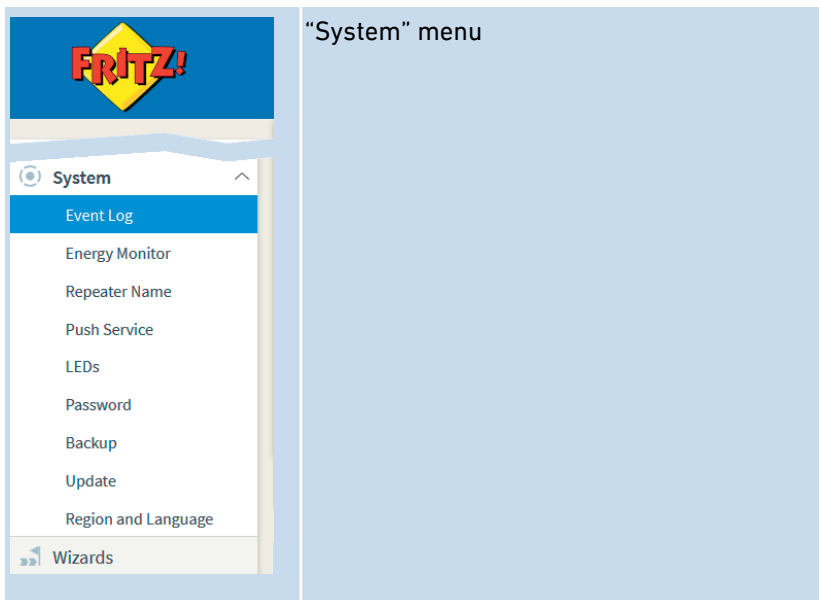

### Description of the Submenus

The online help of the user interface includes a detailed description of the submenus.

## Configuring Push Services

### Overview

You can configure various push services. Push services are notification services that inform you by email about the activities of FRITZ!Repeater and assist you with configuration and operation.

### Available Push Services

You can request push service mails to be notified about the following activities:

Push Service	Function
FRITZ!Repeater info	Sends you regular email messages with data usage and connections
Wireless guest access	Sends a message whenever devices register with or deregister from the wireless guest access
New FRITZ!OS	Informs you about new FRITZ!OS updates
Forgot password	Sends you an access link to the specified email address if you have forgotten your password
Save settings	Before every update, and every time the factory settings are restored: FRITZ!Repeater generates a backup file of the settings and sends the file to the specified email address
Change notice	Sends you an email every time changes are made to a setting or when potentially security-relevant events occur.

### Instructions: Configuring Push Service

1. Open the user interface, [see page 34](#).

2. Select "System / Push Service".
3. For instructions, open the online help .



## Switching LED On and Off

### Overview

You can switch the LED on or off permanently.

### Instructions: Switching the LED On and Off

1. Open the user interface, [see page 34](#).
2. Go to the "System / LEDs" menu.
3. Switch off LED: Enable the "Turn off the LED display" checkbox.  
Switch on LEDs: Disable the checkbox.
4. Click on "Apply".

## Configuring a FRITZ!Repeater Password

### Overview

Set up a password for the FRITZ!Repeater so that the FRITZ!Repeater is protected even when there is no connection to the home network of your FRITZ!Box.

### Rules for Passwords

Comply with the following rules for setting passwords:

- Select a password with at least twelve characters, which includes capitals and lower-case letters as well as numerals and special characters.

Characters Allowed	Illegal Characters
<ul style="list-style-type: none"> <li>• Letters from a to z in lower case and upper case</li> </ul>	<ul style="list-style-type: none"> <li>• The letter ß</li> <li>• Umlauts ä, ö, ü in upper and lower case</li> </ul>
<ul style="list-style-type: none"> <li>• Numerals 0 to 9</li> </ul>	
<ul style="list-style-type: none"> <li>• Spaces</li> </ul>	
<ul style="list-style-type: none"> <li>• Special characters: _ - ! " # \$ % &amp; ' ( ) * + , . / : ; &lt; = &gt; ? @ [ \ ] ^ ' {   } ~</li> </ul>	<ul style="list-style-type: none"> <li>• Special characters: § ´</li> </ul>

- Configure the “Forgot password” push service. When you have forgotten a password, the FRITZ!Repeater sends an access link to the email address you specified. Using this link you can set a new password.



If you lose your FRITZ!Repeater password and did not configure the “Forgot password” push service, you will have to restore the factory settings to your FRITZ!Repeater.

## Instructions: Configuring a FRITZ!Repeater Password

1. Open the user interface, [see page 34](#).
2. Go to the “System / Password” menu.
3. For instructions, open the online help .

## Saving Settings

### Overview

All of the settings on your FRITZ!Repeater can be saved in a file. With this backup file you can restore the settings to the same FRITZ!Repeater device or load your settings to another FRITZ!Repeater. This device must be the same FRITZ!Repeater model.



The settings are saved automatically before every FRITZ!OS update, and every time factory settings are restored, if you configure the “Save Settings” push service.

### Instructions: Saving Settings

1. Open the user interface, [see page 34](#).
2. Select “System / Backup / Save”.
3. For instructions, open the online help .

## Loading Settings

### Overview

FRITZ!Repeater settings you have previously saved can be restored.

- You can restore the settings to the same FRITZ!Repeater.
- You can load the settings to another FRITZ!Repeater.

### Requirements

If you would like to load the settings saved from one FRITZ!Repeater to another FRITZ!Repeater, the following prerequisite must be met:

- Both devices must be the same FRITZ!Repeater model.

### Instructions: Loading Settings

1. Open the user interface, [see page 34](#).
2. Select “System / Backup / Restore”.
3. For instructions, open the online help .

## Updating FRITZ!OS

## Restoring Factory Settings

### Overview

You can restore factory settings to the FRITZ!Repeater.

### Application Scenario

Reset the FRITZ!Repeater in the following cases, for instance:

- You forgot the password for the FRITZ!Repeater user interface
- The FRITZ!Repeater is to be passed on to other users.
- The FRITZ!Repeater is to be disposed of.

### Consequences of Resetting

Restoring the factory settings has the following effect:

- All of the settings are reset to the preconfigured values. The installed version of FRITZ!IOS remains intact.
- The repeater name is reset to fritz.repeater.
- The FRITZ!Repeater password is reset.

### Instructions: Restoring Factory Settings to FRITZ!Repeater



All of the settings you configured are deleted and reset to the factory settings.

1. Open the user interface, [see page 34](#).
2. Select "System / Backup".
3. Select the "Factory Settings" tab.
4. Click on the "Load Factory Settings" button.



If you intend to restart operation of the FRITZ!Repeater after the reset, we recommend updating the FRITZ!IOS; [see page 62](#).

# Malfunctions

Troubleshooting Procedures ..... 65





## Troubleshooting Procedures

### Overview

Use the following sources of help for various kinds of malfunctions:

Malfunction	Help
<ul style="list-style-type: none"><li>• A wireless LAN connection to the FRITZ!Box cannot be established.</li><li>• A wireless LAN connection to another wireless router cannot be established.</li></ul>	Troubleshooting chart; <a href="#">see page 66</a>
Problem with: <ul style="list-style-type: none"><li>• Configuration</li><li>• Wireless</li><li>• Internet</li><li>• etc.</li></ul>	Knowledge Base; <a href="#">see page 67</a>
Troubleshooting chart and Knowledge Base do not offer a solution.	Support; <a href="#">see page 67</a>

## Troubleshooting Chart

Error Scenario	Cause	Solution
A wireless LAN connection to the FRITZ!Box cannot be established.	Keylock of the FRITZ!Box enabled.	Disable the keylock in the user interface of the FRITZ!Box ( <a href="http://fritz.box">http://fritz.box</a> ) under "System / Buttons and LEDs".
	WPS is switched off in FRITZ!Box.	Enable the settings "WPS enabled" and "Push-Button method (WPS-PBC)" in the FRITZ!Box.
	The MAC address filter of the FRITZ!Box is enabled.	Enable the "Allow all new wireless devices" setting in the FRITZ!Box. This setting is located under "Wireless / Security" or "Wireless / Radio Network" in the user interface ( <a href="http://fritz.box">http://fritz.box</a> ). The Advanced view must be enabled in the user interface.
	WPS is switched off in FRITZ!Box.	Enable the settings "WPS enabled" and "Push-Button method (WPS-PBC)" in the FRITZ!Box.  You can find the settings in the user interface ( <a href="http://fritz.box">http://fritz.box</a> ) under "Wireless / Security / WPS Quick Connection".
A wireless LAN connection to another wireless router	WPS is switched off in the wireless router.	Enable WPS in the wireless router. Instructions are provided by the manufacturer, for instance, in the device manual.

Error Scenario	Cause	Solution
cannot be established.	The MAC address filter of the wireless router is enabled.	Disable the wireless router's MAC address filter. Instructions are provided by the manufacturer, for instance, in the device manual.  After establishing the wireless connection you can disable the MAC address filter again.
	Unsuitable wireless encryption configured in the wireless router.	Enable the encryption method WPA2 (CCMP) or WPA (TKIP) in the wireless router. Instructions are provided by the manufacturer, for instance, in the device manual.

### AVM Knowledge Base

The AVM Knowledge Base is available online at:  
[en.avm.de/service](http://en.avm.de/service)

### Support

The Support team assists you in resolving any technical problems with your FRITZ! products.

You can send an email to the support team using the support form on our website. Our Support team will respond to your request by email within one working day. The support form is available at:  
[en.avm.de/service](http://en.avm.de/service)

# Appendix

Technical Specifications..... 69  
Legal..... 71  
Information on Cleaning..... 75  
Disposal ..... 76



## Technical Specifications

### Device Properties

Property	Value
Dimensions (W x H x D)	approx. 64 mm x 64 mm x 64 mm
Supply voltage	230 V / 50 Hz
Certification	Conforms to CE standards

### Ambient Conditions

Property	Value
Operating temperature	0 °C – +40 °C
Relative humidity (operation)	10 % – 90 %

### Active Power

Property	Value
Average active power	approx. 2 W

### Wireless LAN Radio Frequencies

Frequency	Frequency Range	Maximum Transmitter Power
2.4 GHz	2400 MHz – 2483 MHz	100 mW

## Ports and Interfaces

Connected via	Interface
Wireless	Wireless access point with support for wireless LAN radio networks (wireless standard – data rate) <ul style="list-style-type: none"><li>• IEEE 802.11b – 11 Mbit/s</li><li>• IEEE 802.11g – 54 Mbit/s</li><li>• IEEE 802.11n – 600 Mbit/s</li></ul>

---

## Legal

### Manufacturer's Warranty

We offer a manufacturer's warranty of 5 years on the hardware of this original product. The warranty period begins with the date of purchase by the first end user. Compliance with the warranty period can be proven by submission of the original invoice or comparable documents. This warranty does not restrict your warranty rights based on the contract of sale or other statutory rights.

Within the warranty period, we will remove defects to the product which are demonstrably due to faults in materials or manufacturing. Our warranty does not cover defects which occur due to incorrect installation, improper use, non-observance of instructions in the user manual, normal wear and tear or defects in the environment of the system (third-party hardware or software). We may, at our discretion, repair or replace the defective product. Claims other than the right to the removal of defects which is mentioned in these terms of warranty are not constituted.

We guarantee that the software conforms with general specifications, not, however, that the software meets your individual requirements. Delivery costs will not be reimbursed. Products which have been replaced revert to our ownership. Claims recognized under warranty entail neither an extension or recommencement of the warranty period. If we reject a warranty claim, this claim lapses no later than six months after being rejected by us.

This warranty shall be governed by German substantive law, to the exclusion of the United Nations Convention on Contracts for the International Sale of Goods (CISG).

### Legal Notice

This documentation and the software it describes (both now called "software") are protected by copyright.



Please inform us about contents that are erroneous or no longer up to date at [info@avm.de](mailto:info@avm.de).

Software is delivered in machine-readable format only (object code format). Under all AVM intellectual property rights, AVM hereby grants licensee the non-exclusive right to use the software. Unless agreed for a limited time period, the right to use the software is for an unlimited time period. The licensee may create only one copy of the software, which may be used exclusively for backup use. Unless granted by mandatory law (including but not limited to Art. 69 German Copyright Act for decompiling), licensee shall not be entitled to modify, disassemble, reverse engineer, decompile or otherwise alter the software in whole or in part. AVM reserves all intellectual property rights except as expressly granted herein. Licensee shall not be entitled to modify or delete alpha-numerical or other identification codes on data media and shall transfer such identification codes onto any legal backup copy. Without the prior written approval of AVM, licensee shall not be entitled to transmit any information made available herein.

If licensee has received the software not for commercial purposes of resale (end user), licensee shall be obliged to transmit the right to use the software to a third party only in connection with the product license acquired together with the software. In the event that licensee transfers the right to use the software to a third party, licensee shall ensure not to grant further rights to this third party than originally granted to AVM, and licensee shall ensure to impose upon this third party the obligations of the present license terms. In such case, licensee shall not withhold any backup copy. Licensee shall not be entitled to grant sublicenses. In the event licensee transmits the software to a third party, licensee shall be responsible for and shall release AVM insofar from the compliance of export control laws and obligations.

If and insofar AVM provides software for which AVM is only granted a derived right to use (third party software), the license terms for such third party software shall additionally apply and prevail. If and insofar



certain third party software in object code format by Texas Instrument (“TI software”) is provided together with this software, licensee may only distribute such TI software pursuant to a written license agreement which restricts use to TI software embedded in the AVM hardware product licensee acquired together with the software and prohibits (unless granted by mandatory law) copying, reverse engineering, decompiling or disassembling of TI software. If open source software is provided, the license terms for such open source software shall additionally apply and prevail. AVM shall provide licensee with the corresponding source code of relevant open source software, if the respective license terms of the open source software include such obligation. AVM shall inform if the software contains third party software and/or open source software and make available the corresponding license terms on request.

The licensing conditions are presented in the help for the FRITZ!Repeater 600 user interface under the “Legal Notice” heading.

This documentation and the software have been produced with all due care and checked for correctness in accordance with the best available technology. AVM disclaims all liability and warranties, whether express or implied, relating to this software's quality, performance or suitability for any given purpose which deviates from the performance specifications contained in the software description. AVM will not be liable for damages arising directly or indirectly from the use of the documentation or related software, nor for incidental or consequential damages, except in case of intent or gross negligence. AVM explicitly disclaims all liability for loss of or damage to hardware, software or data in connection with direct or indirect errors or destruction, for cases of damage (including fraud cases) incurred due to deficient or incorrect configurations (including configurations that use insufficient or no password protection) over connections (including, but not limited to broadband connections like DSL, cable/DOCSIS and fiber optic, also including VoIP or SIP connections), and for any and all costs, including connection charges, related to the software supplied and its documentation or due to incorrect installations not performed by AVM.

AVM accepts no obligations to perform software service. These require a separate agreement. The information in this documentation and the software it describes are subject to change without notice for the purpose of technical improvement.

Marks: Marks like AVM, FRITZ! and FRITZ!Box (product names and logos) are protected marks owned by AVM GmbH. Microsoft, Windows and the Windows logo are marks owned by Microsoft Corporation in the USA and/or other countries. Apple, App Store, iPhone, iPod and iPad are marks owned by Apple Inc. in the USA and/or other countries. IOS is a mark owned by Cisco Technology Inc. in den USA and/or other countries. Google and Android are marks owned by Google Inc. in the USA and/or other countries. All other product and company names are trademarks of their respective owners.

## Copyright



© AVM 2019. All rights reserved.

AVM Audiovisuelles Marketing  
und Computersysteme GmbH

Alt-Moabit 95

D-10559 Berlin

AVM in the internet: [en.avm.de](http://en.avm.de)

AVM Computersysteme  
Vertriebs GmbH

Alt-Moabit 95

D-10559 Berlin

## Declaration of CE Conformity

AVM declares herewith that the device is compliant with the basic requirements and the relevant rules in directives 2014/53/EU, 2009/125/EC and 2011/65/EU.

The long version of the declaration of CE conformity is available at [en.avm.de/ce](http://en.avm.de/ce).

## Information on Cleaning

### Rules

Keep the following rules in mind for cleaning your FRITZ!Repeater:

- Remove the FRITZ!Repeater from the mains before cleaning.
- Wipe the FRITZ!Repeater with a slightly moist, lint-free cloth or an antistatic cloth.
- Do not use any strong detergents or solvents for cleaning.
- Do not use any wet cloths for cleaning.

## Disposal

### Disposal of Used Devices

In accordance with European regulations, the FRITZ!Repeater, as well as all devices and electronic components contained in the package, may not be disposed with household waste.

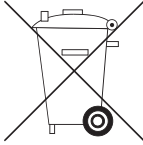

After use, please dispose of the FRITZ!Repeater and all electronic components and devices included with delivery at a collection point in your local community for the disposal of electric and electronic appliances.

# Index

## A

- active power..... 69
- AVM services..... 34, 39

## B

- button..... 13

## C

- cables..... 10
- CE conformity declaration..... 74
- choice of location..... 69
- cleaning..... 6, 75
- configuration..... 33, 34
- configuring
  - push services..... 55
  - schedule..... 50
- connect
  - wireless devices..... 31
- connecting..... 17
  - FRITZ!Box..... 18
  - router ..... 20
- connecting network devices..... 30
- connection data..... 55
- conventions..... 8
- copyright..... 74
- corporate info..... 74
- customer documentation..... 7

## D

- data
  - push services..... 55
  - saving ..... 60
- data protection..... 39
- declaration of CE conformity..... 74
- device properties..... 69
- diagnostics and maintenance..... 34
- disposal..... 76
- documentation..... 7

## E

- email notifications..... 55

## F

- factory settings..... 13, 63
- features..... 11, 12
- firmware update..... 62
- flashing LEDs..... 14
- FRITZ!OS
  - loading settings..... 61
  - restoring settings..... 61
  - saving settings..... 60
  - updating..... 62
- functions..... 11, 12

## G

- guest access..... 52
- GUI ..... 33

## H

- hazard warnings..... 5
- help with problems
  - troubleshooting chart..... 66
- hotspot (wireless LAN)..... 52
- humidity..... 69

## I

- interfaces..... 70
- IP address..... 47

## L

- LED ..... 14
  - meaning..... 14
  - switching on/off..... 57
- legal notice..... 71
- light-emitting diode..... 14
  - meaning..... 14
- log files..... 55
- log information..... 55

**M**

manufacturer's warranty.....	71
menus in the user interface	
access to home network.....	41
network.....	45
System.....	53
Wireless.....	48
Mesh.....	25

**N**

network.....	46
night service.....	50
notification settings.....	55
notifications.....	55
forgot password.....	55
new FRITZIOS.....	55
wireless guest access.....	55

**O**

online help.....	7
operating system: FRITZIOS	
updating.....	62
operating temperature.....	69
operation requirements.....	16

**P**

package contents.....	10
password	
configuration.....	58
forgot .....	55, 58
setting up.....	58
password rules.....	58
ports.....	70
power consumption.....	69
power input.....	69
push services.....	55

**Q**

quick guide.....	7
------------------	---

**R**

radio network name (SSID).....	51
recycling.....	76
requirements for operation.....	16
reset.....	13
resetting.....	63

resolving problems.....	64
roaming.....	51

**S**

safety	
safety instructions.....	5
safety instructions.....	5
schedule.....	50
security	
info mail.....	55
password.....	58
push services.....	55
saving settings.....	60
sending backup file.....	55
settings.....	33
loading .....	61
notifications.....	55
restoring.....	61
saving .....	60
sending backup file.....	55
user interface.....	33
software: FRITZIOS	
updating.....	62
SSID .....	51
starting operation.....	17
storage temperature.....	69
structure.....	11
support.....	7
symbols.....	8
system settings.....	54

**T**

technical specifications.....	69
ambient conditions.....	69
device properties.....	69
humidity.....	69
temperature.....	69
wireless LAN radio frequencies.....	69
troubleshooting.....	7, 64
documentation.....	7
type label.....	9

**U**

update.....	62
usage data.....	55

---

user interface.....	33, 33
AVM services.....	34
factory settings.....	63
firmware update.....	62
opening.....	34
updating FRITZ!OS.....	62
<b>W</b>	
warranty.....	71
wireless connection	
other router.....	20, 21
wireless guest access.....	52
wireless LAN	
configuring radio network.....	49
connect devices.....	31
Mesh .....	25
radio frequencies.....	69
schedule.....	50
WPS .....	20
wireless LAN frequency ranges.....	69
wireless LAN radio frequencies.....	69
wireless network	
SSID .....	51
standards.....	70
wireless network connection	
FRITZ!Box.....	18