

SinoVoip Co., Limited

BPI-R1

User Manual



The BPI- R1 is a 300Mbps Wireless N Router with both wired and wireless network connections designed specifically for smart home networking use. With 2T2R MIMO Technology and two detachable antennas, the R1 is the dual core Android 4.2 product which more better than Linux product. It can run with Android 4.2.2 smoothly and with Gigabit ethernet port, SATA Socket, it can easily run with the game and support 1080P high definition video output.

Hardware specification

CPU	A20 ARM Cortex™-A7 Dual-Core
GPU	ARM Mali400MP2Complies with OpenGL ES 2.0/1.1
Memory (SDRAM)	1GB DDR3 (shared with GPU)
Onboard Storage	Micro SD (Max. 64GB) card slot UP to 2T on 2.5 SATA disk
Onboard Network	10/100/1000 Ethernet RJ45, WLAN @802.11b/g/n
Video Input	A CSI input connector allows for the connection of a designed camera module
Video Outputs	HDMI , LVDS/RGB
Audio Output	3.5 mm Jack and HDMI
Audio Input	Microphone
Power Source	5 volt via Micro USB(DC In Only)
USB 2.0 Ports	USB Host and Micro USB (OTG)
Buttons	Reset button: Next to Power button
	Power button: Next to Battery connector
GPIO(2X13) pin	GPIO,UART,I2C bus ,SPI bus with two chip selects, CAN bus,ADC,PWM,+3.3v,+5v,ground.
LED	Power Key & RJ45
Remote	IR
OS	Android 4.2, Linux

Interface definition

Product size	148 mm × 100mm
Weight	83g

Hardware

Front:

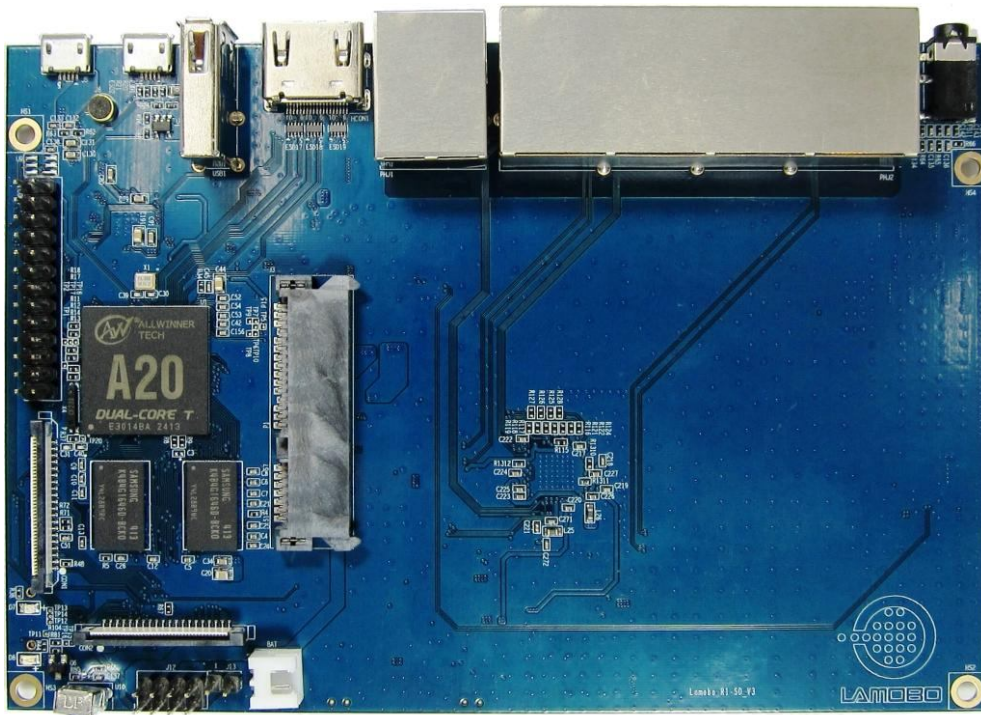

Back:

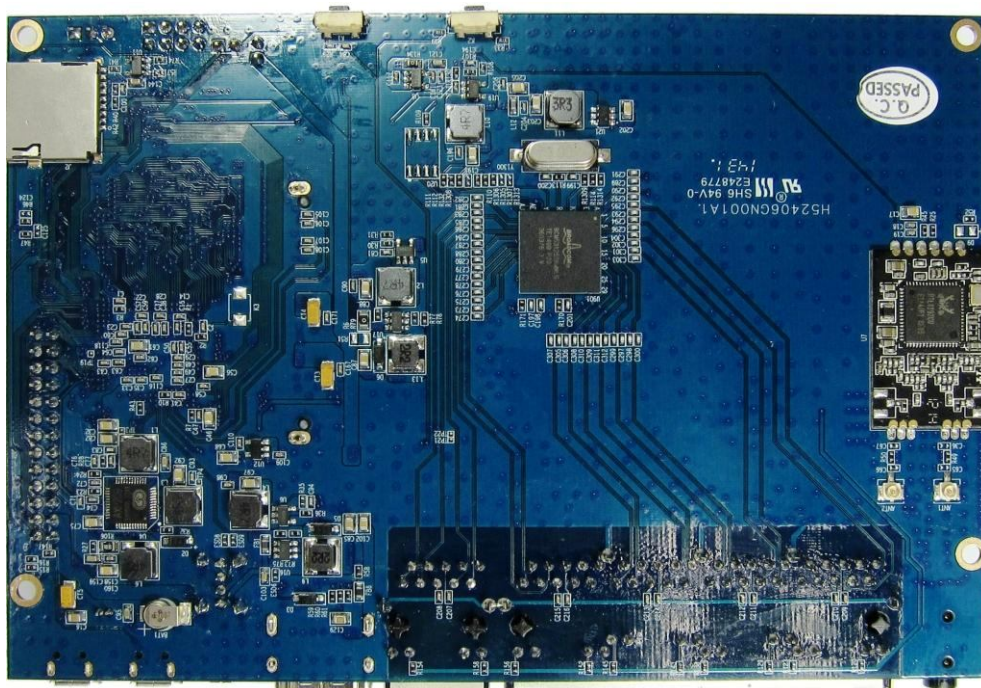

Interface :

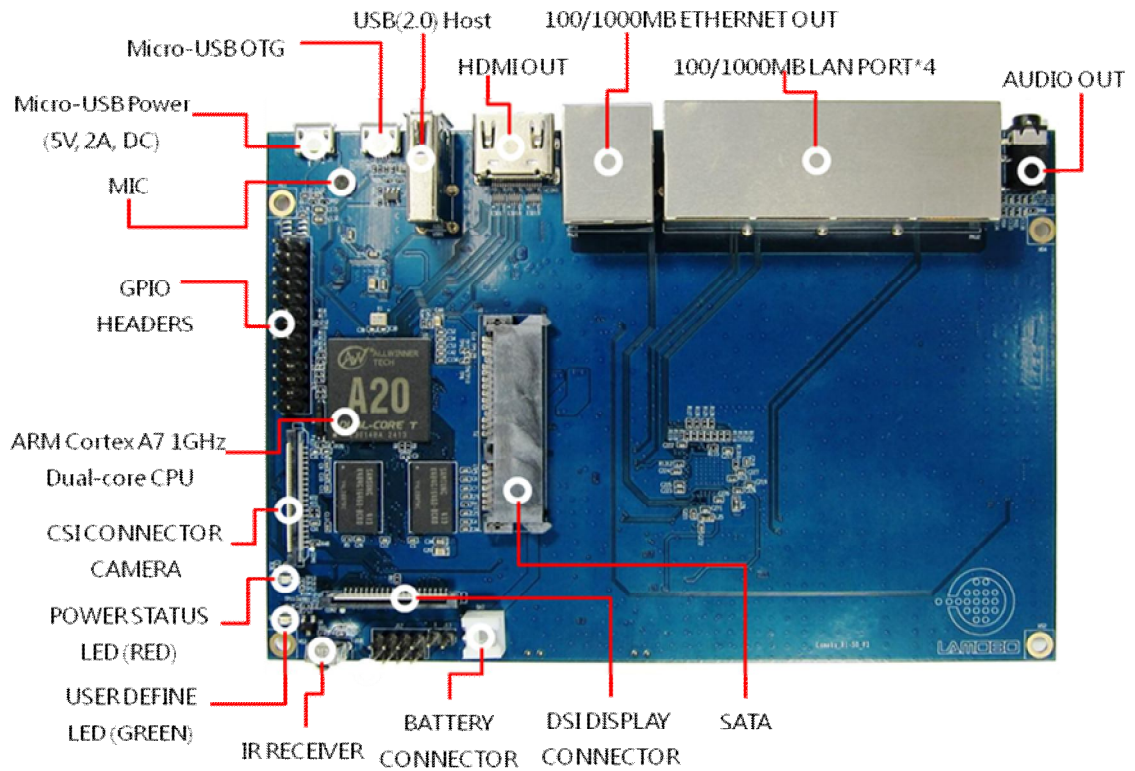

Front side

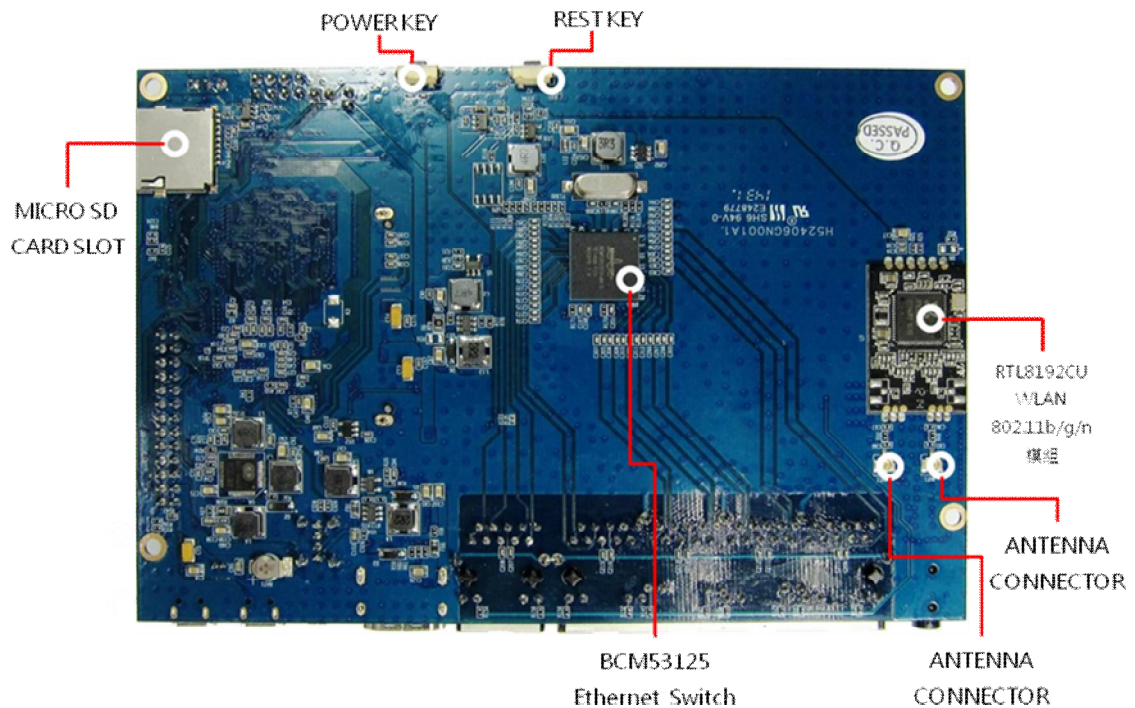

Back side

Hardware connect sketch map

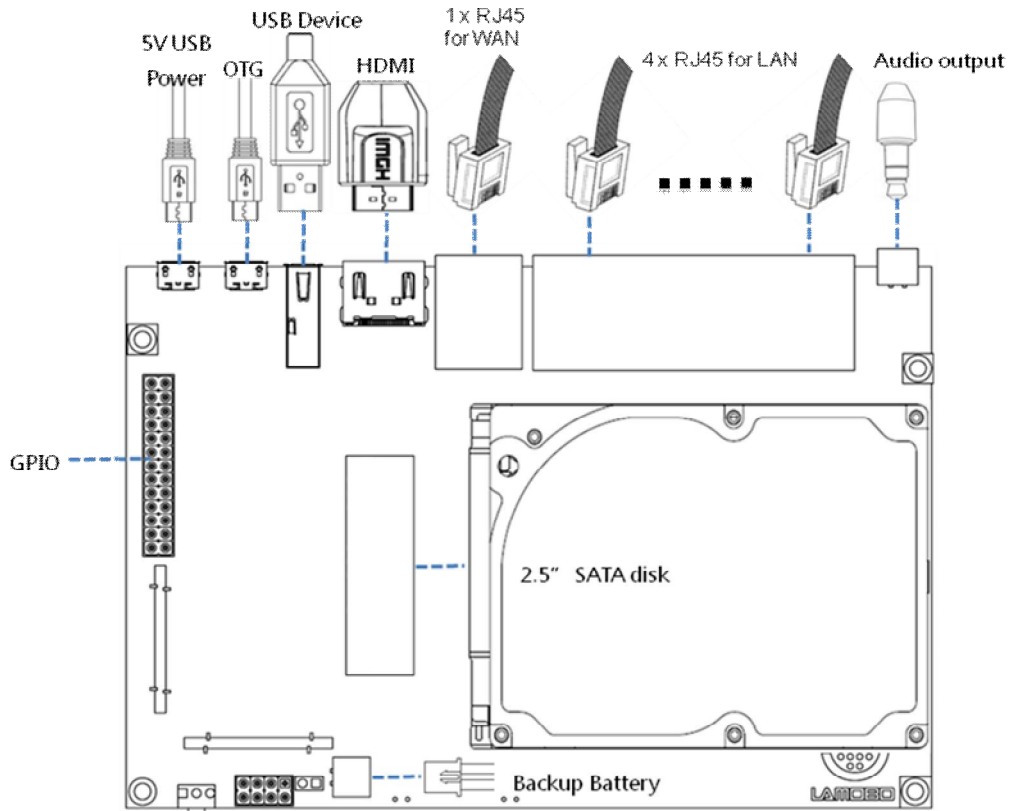

Front side

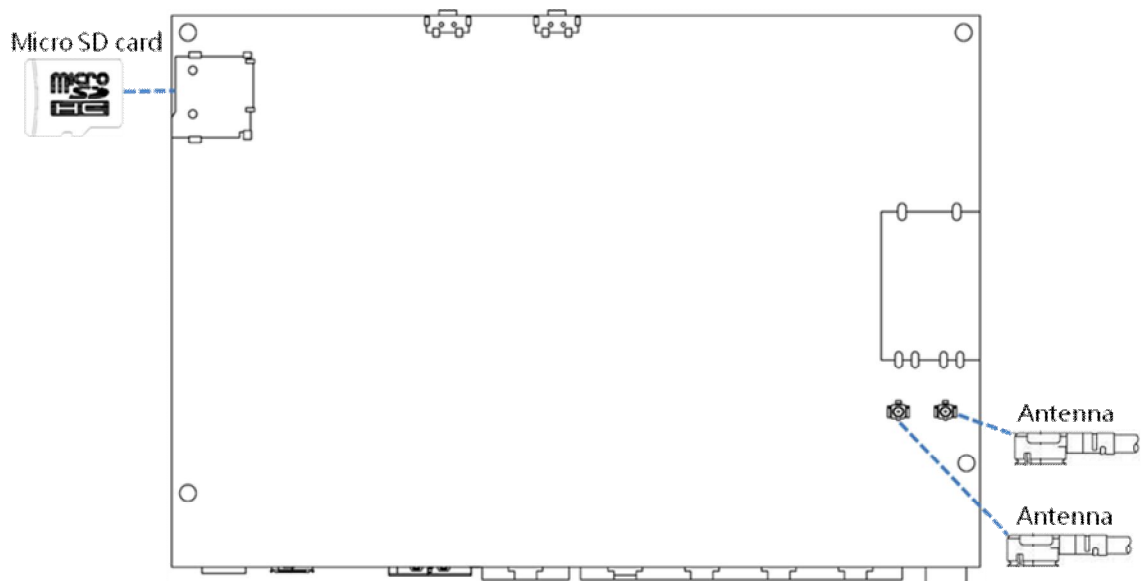

Back side

Use method

Step 1: Get what you need

First time to enjoy your R1, you need at least the accessories in the table below.

No.	Item	Minimu recommended specification & notes
1	Micro SD card	<ul style="list-style-type: none"> Minimum size 8Gb; class 10 (the class indicates how fast the card is). We recommend using branded SD cards as they are more reliable.
2	HDMI(Full sized) to HDMI / DVI lead	<ul style="list-style-type: none"> HDMI to HDMI lead (for HD TVs and monitors with HDMI input).ORHDMI to DVI lead (for monitors with DVI input).
3	Mouse	<ul style="list-style-type: none"> Any standard USB keyboard and mouse should work. Mice or Keyboards that take a lot of power from the USB ports, however, may need a powered USB hub. This may include some wireless devices.
4	Ethernet cable	<ul style="list-style-type: none"> Networking is must of router.
5	Micro USB power adapter	<ul style="list-style-type: none"> A good quality, micro USB power supply that can provide at least 2A at 5V is essential.
6	Audio lead (Optional)	<ul style="list-style-type: none"> You can choose a 3.5mm jack audio lead to connect to audio port to get stereo audio.
7	Mobile Hard disk (Optional)	<ul style="list-style-type: none"> You can choose to connect a mobile hard disk to SATA port to store more files.
8	Antenna	<ul style="list-style-type: none"> You can choose two 2.4GHz WIFI antennas to connect to antenna ports to get advanced wireless performance.



HDMI to HDMI lead



HDMI to DVI lead



Micro SD card



Micro USB power adapter

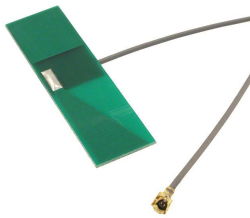

WiFi antenna

Step 2: Download the relevant Image file:

Please visit our webmaster: <http://www.bananapi.com> to download image ,R1 all image can be downlad form this web.

Step3: Prepare your Micro SD card for the R1

In order to enjoy your R1, you will need to install an Operating System (OS) onto an micro SD card. Instructions below will teach you how to write an OS image to your SD card under Windows.

1. Insert your micro SD card into your computer. The size of micro SD should be larger than the OS image size, generally 8GB or greater.
2. Format the micro SD card.

Windows:

- i. Download the a micro SD card format tool such as **SD Formatter** from https://www.sdcard.org/downloads/formatter_4/eula_windows/
- ii. Unzip the download file and run the setup.exe to install the tool on your machine.
- iii. In the "Options" menu, set "FORMAT TYPE" option to QUICK, "FORMAT SIZE ADJUSTMENT" option to "ON".

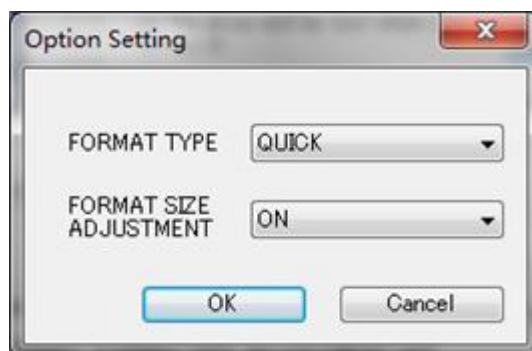

- iv. Check that the SD card you inserted matches the one selected by the Tool.
 - v. Click the "Format" button.
3. Download the OS image from Download district.

4. Unzip the download file to get the OS image.
5. Write the image file to the micro SD card.

5.1 Preparing

- 5.1.1 Insert the SD card to PC.
- 5.1.2 Unpack PhoenixCard_V309.rar you received.
- 5.1.3 Open it:

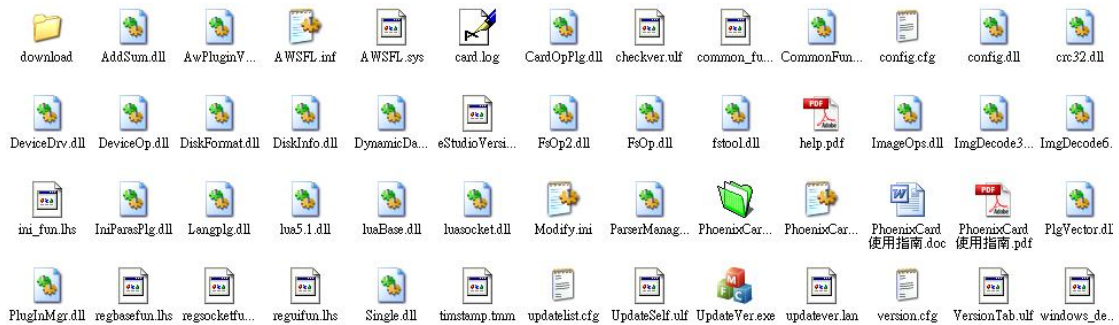

5.2 Run PhoenixCard.exe

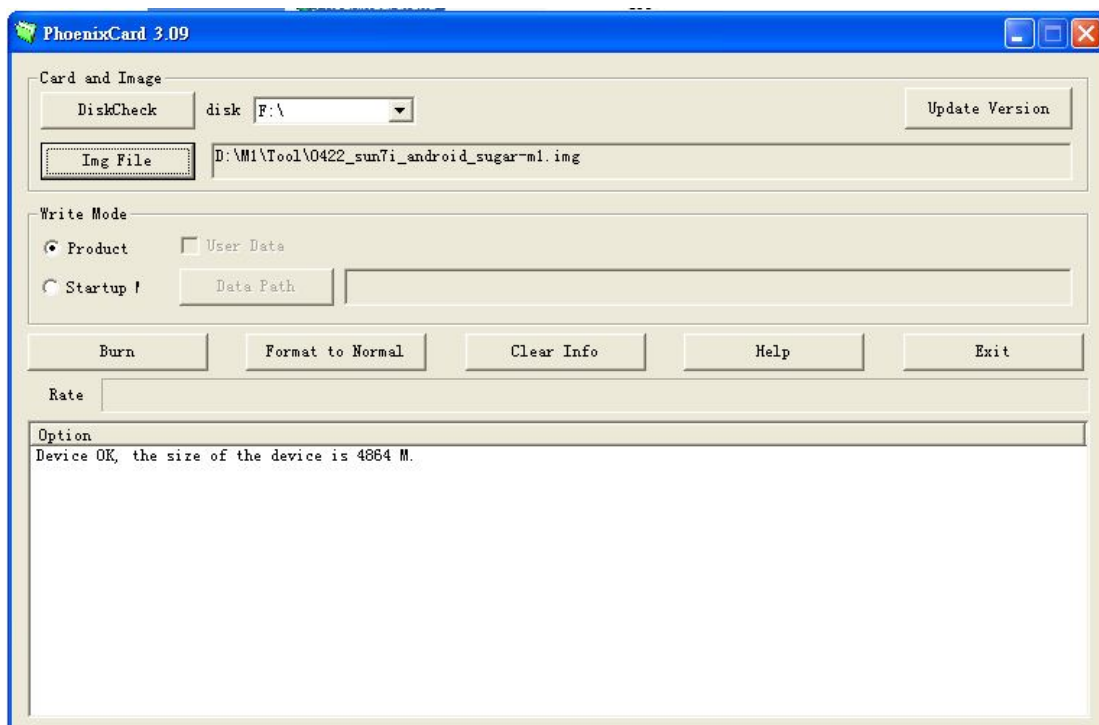
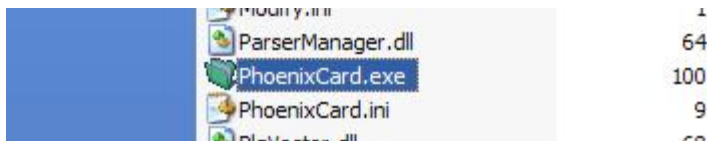

5.3 Press “DiskCheck” and select disk of SD Card.

5.4 Press “Img File” and Select system.img

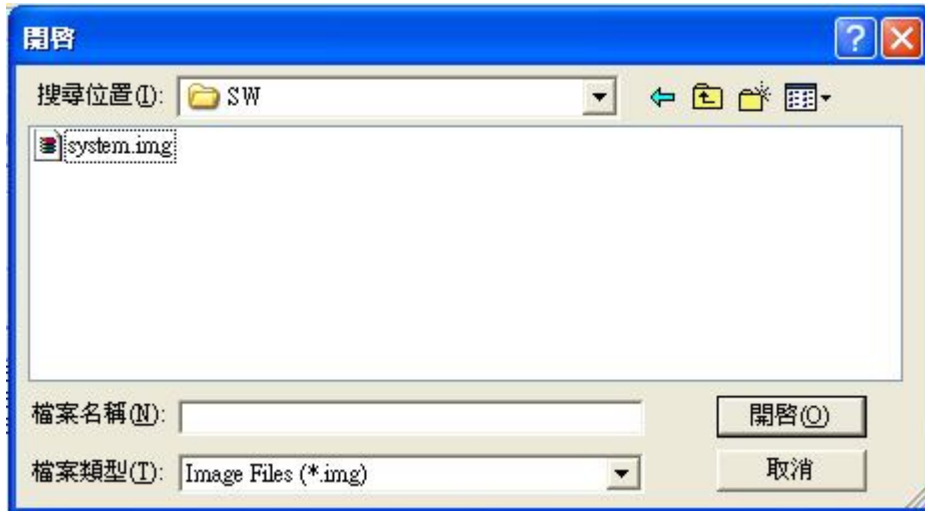

5.5 Select “Startup” and press “確定”

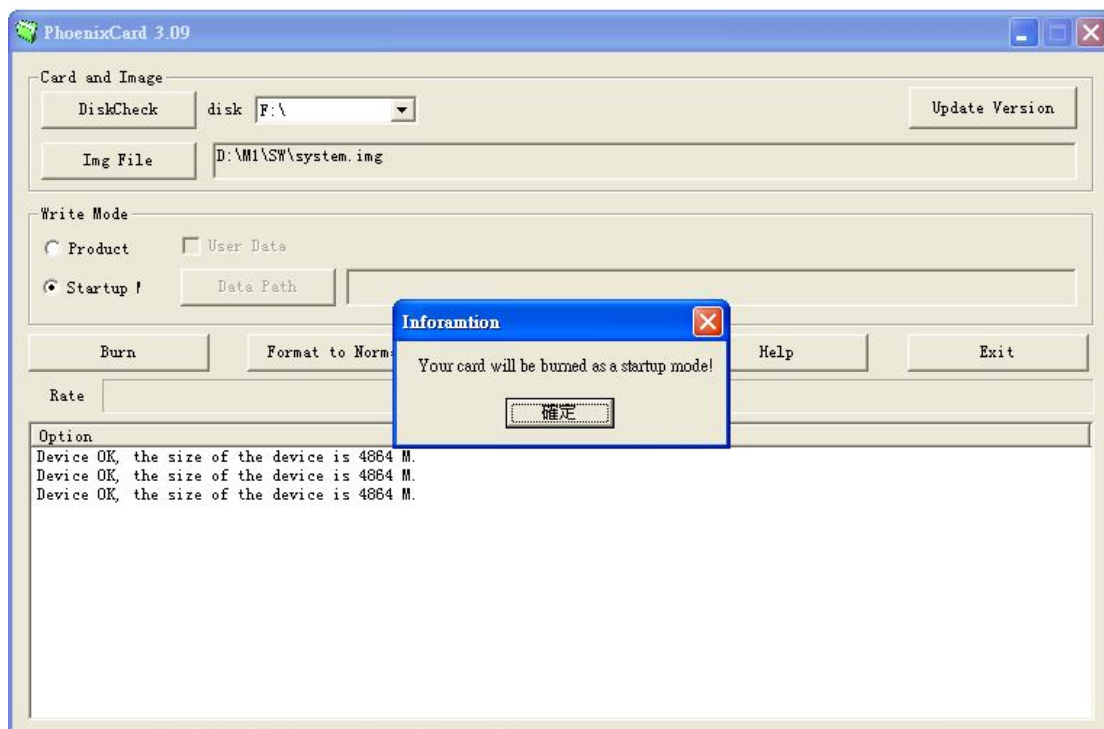

5.6 Press “Burn”

start upgrading

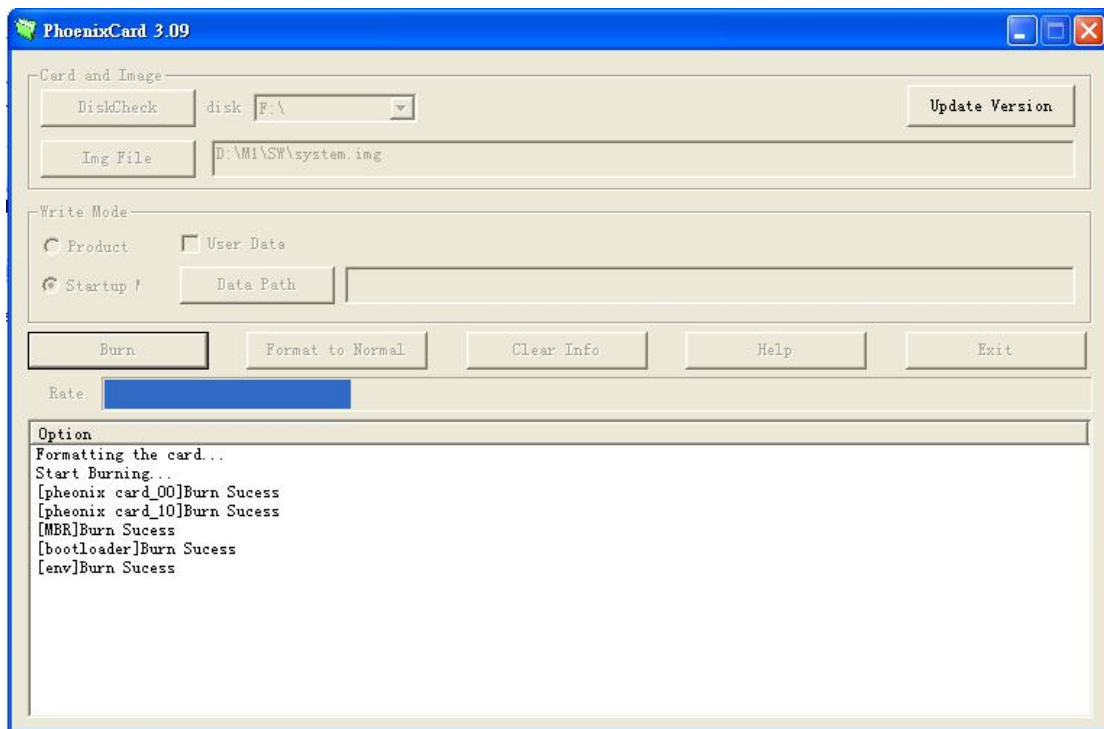

5.7 Upgraded complete.

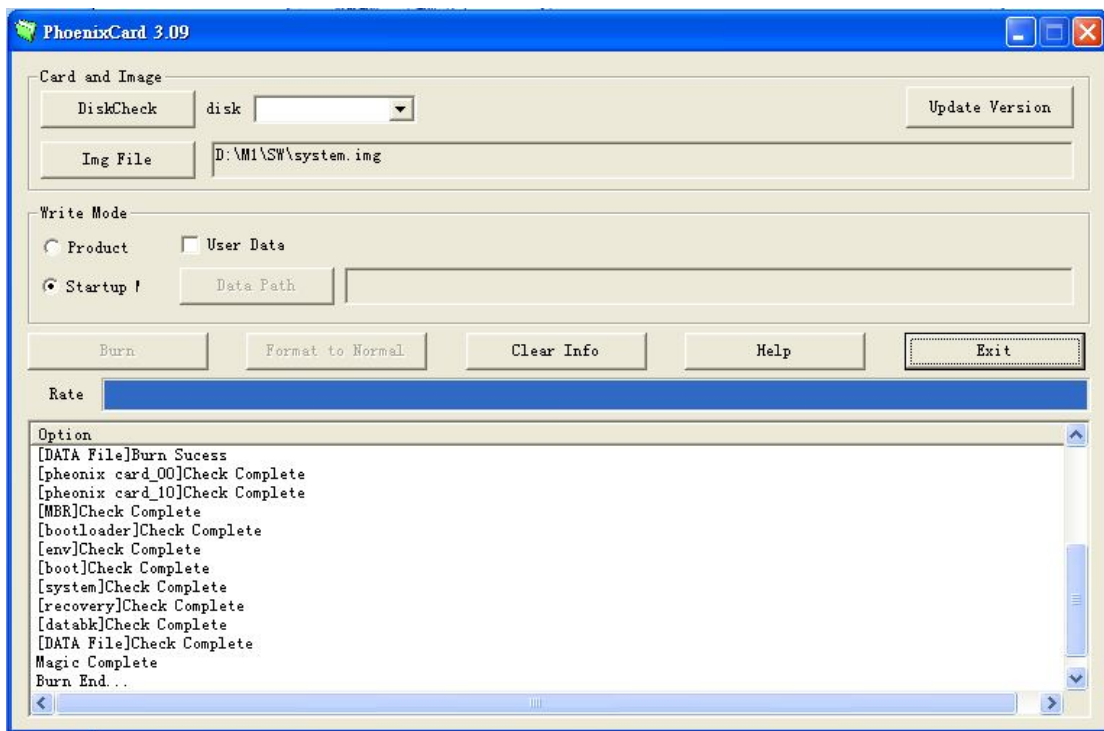

5.8 Press “Exit”

Step4: Set up your R1

According to the set up diagram below, you can easily set up your R1.

1. Insert the written-image micro SD card that to the micro SD card slot on the left side edge of the underside of the board.
2. The HDMI Type A (Full sized) port is between a USB port and a RJ45 port of the board. Just connect any HDMI cable from the board to your TV or HDMI Monitor.
3. Plug a mouse into the USB slot.
4. Plug a Ethernet cable into the RJ45 slot.
5. Finally, at the very left of the bottom edge is the micro-usb power connector. Plug in a regulated power supply that is rated at 5V \pm 2% and at least 2A.

If all goes well, the R1 will boot in a few minutes. The screen will display the OS GUI.

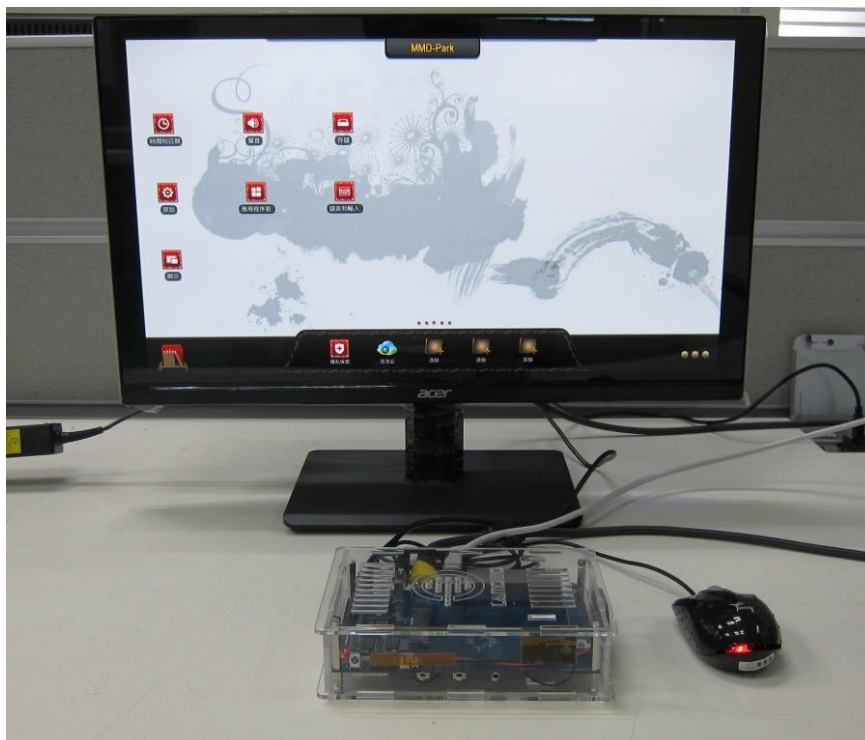

Step5: Shut down your R1

This will shut down the PI safely, (just use the power key to turn off might damage the SD-cards file system). After that you can press the power key for 5 seconds to turn it off.

If all is well ,the splash screen show as below

Android system screen



GPIO define

We can check R1 PIN definition in this thread, including CON1, CON2, CON3, J12 and J13.

J13 contains the default serial port UART0 (UART0-RX,UART0-TX). UATRO is configured to be used for console input/output. Whilst this is useful if you want to login using the serial port. So it is the most common used PIN.

J12 also contains serial port.

CON3 contains CAN bus, SPI bus, PWM, serial port and etc. It can be configured to be used for kinds of peripherals.

CON1 is a CSI camera connector.

CON2 is a DSI display connector.

Pictures and tables below show the specific layout and definition of PIN.

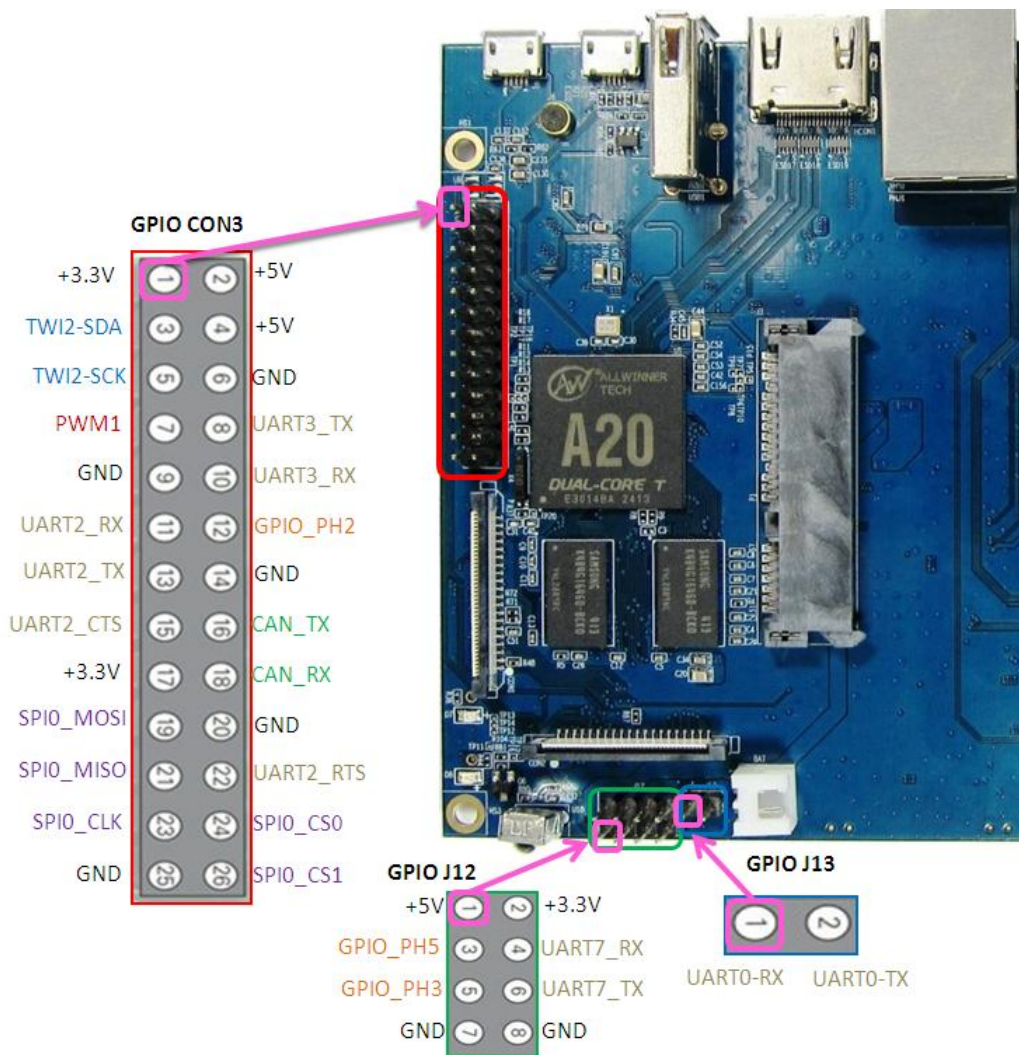
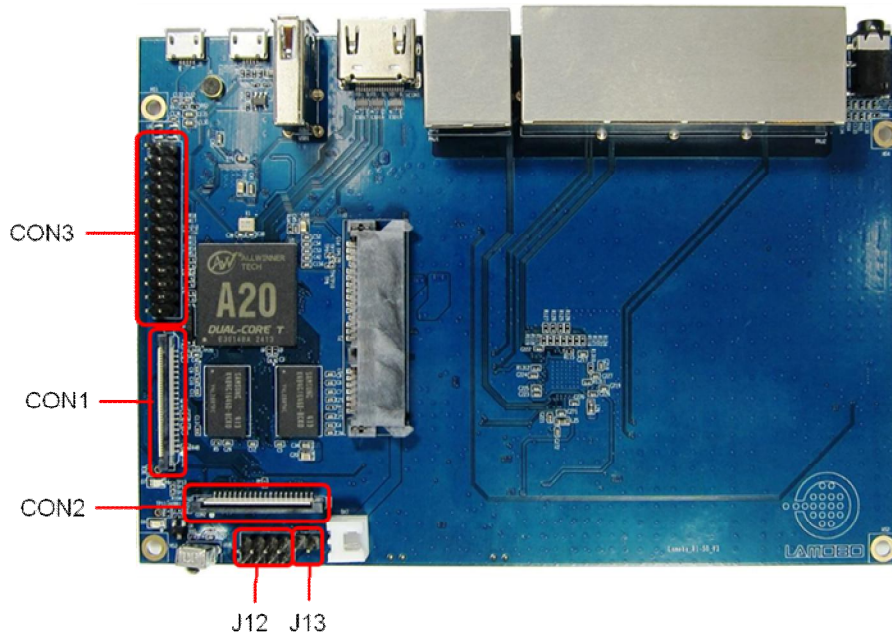

R1 PIN define

PIN	PIN define	GPIO
CON1-P01	LINEINL	
CON1-P02	LINEINR	
CON1-P37	HPL	
CON1-P36	HPR	
CON1-P07	FMINL	
CON1-P09	FMINR	
CON1-P04	ADC_X1	
CON1-P06	ADC_X2	
CON1-P08	ADC_Y1	
CON1-P10	ADC_Y2	
CON1-P13	LRADC0	
CON1-P15	LRADC1	
CON1-P33	RESET#	
CON1-P17	CSI0-D0	PE4
CON1-P19	CSI0-D1	PE5
CON1-P21	CSI0-D2	PE6
CON1-P23	CSI0-D3	PE7
CON1-P25	CSI0-D4	PE8
CON1-P27	CSI0-D5	PE9
CON1-P29	CSI0-D6	PE10
CON1-P31	CSI0-D7	PE11
CON1-P20	CSI0-PCLK	PE0
CON1-P24	CSI0-MCLK	PE1
CON1-P28	CSI0-VSYNC	PE3
CON1-P30	CSI0-HSYNC	PE2
CON1-P18	CSI0-STBY-EN	PH19
CON1-P26	CSI0-RESET#	PH14
CON1-P32	CSI1-STBY-EN	PH18
CON1-P34	CSI1-RESET#	PH13
CON1-P14	TWI1-SDA	PB19
CON1-P16	TWI1-SCK	PB18
CON1-P12	CSI0-FLASH	PH17

CON1-P22	CSI0-PWR-EN	PH16
CON1-P35	CSI-I00	PH11
CON1-P38	IPSOUT	
CON1-P40	IPSOUT	
CON1-P05	GND	
CON1-P11	GND	
CON1-P39	GND	
CON1-P03	VCC-CSI	

CON2-P09	LCD0-D00	PD0
CON2-P11	LCD0-D01	PD1
CON2-P13	LCD0-D02	PD2
CON2-P15	LCD0-D03	PD3
CON2-P17	LCD0-D04	PD4
CON2-P19	LCD0-D05	PD5
CON2-P21	LCD0-D06	PD6
CON2-P23	LCD0-D07	PD7
CON2-P25	LCD0-D08	PD8
CON2-P27	LCD0-D09	PD9
CON2-P29	LCD0-D10	PD10
CON2-P31	LCD0-D11	PD11
CON2-P33	LCD0-D12	PD12
CON2-P35	LCD0-D13	PD13
CON2-P37	LCD0-D14	PD14
CON2-P39	LCD0-D15	PD15
CON2-P40	LCD0-D16	PD16
CON2-P38	LCD0-D17	PD17
CON2-P36	LCD0-D18	PD18
CON2-P34	LCD0-D19	PD19
CON2-P32	LCD0-D20	PD20
CON2-P30	LCD0-D21	PD21
CON2-P28	LCD0-D22	PD22
CON2-P26	LCD0-D23	PD23
CON2-P22	LCD0-CLK	PD24
CON2-P20	LCD0-CS	PH6
CON2-P18	LCD0-HSYNC	PD26

CON2-P16	LCD0-VSYNC	PD27
CON2-P14	LCD0-DE	PD25
CON2-P12	LCD0-I02	PH9
CON2-P10	PWM0	PB2
CON2-P08	LCD0-I01	PH8
CON2-P06	LCD0-I00	PH7
CON2-P04	TWI3-SCK	PI0
CON2-P02	TWI3-SDA	PI1
CON2-P01	IPSOUT	
CON2-P03	IPSOUT	
CON2-P05	GND	
CON2-P24	GND	
CON2-P07	VCC-3V3	

CON3-P18	CAN_RX	PH21
CON3-P16	CAN_TX	PH20
CON3-P23	SPIO_CLK	PI11
CON3-P21	SPIO_MISO	PI13
CON3-P19	SPIO_MOSI	PI12
CON3-P24	SPIO_CS0	PI10
CON3-P26	SPIO_CS1	PI14
CON3-P05	TWI2-SCK	PB20
CON3-P03	TWI2-SDA	PB21
CON3-P15	UART2_CTS	PI17
CON3-P22	UART2_RTS	PI16
CON3-P11	UART2_RX	PI19
CON3-P13	UART2_TX	PI18
CON3-P10	UART3_RX	PH1
CON3-P08	UART3_TX	PH0
CON3-P12	PH2	PH2
CON3-P07	PWM1	PI3
CON3-P01	VCC-3V3	
CON3-P17	VCC-3V3	
CON3-P02	VCC-5V	
CON3-P04	VCC-5V	
CON3-P09	GND	

CON3-P25	GND	
CON3-P06	GND	
CON3-P14	GND	
CON3-P20	GND	

J12-P03	PH5	PH5
J12-P05	PH3	PH3
J12-P04	UART7_RX	PI21
J12-P06	UART7_TX	PI20
J12-P01	VCC-5V	
J12-P02	VCC-3V3	
J12-P07	GND	
J12-P08	GND	

J13-P01	UART0-RX	PB23
J13-P02	UART0-TX	PB22

R1 UART define

