

6.5 Alarm Types

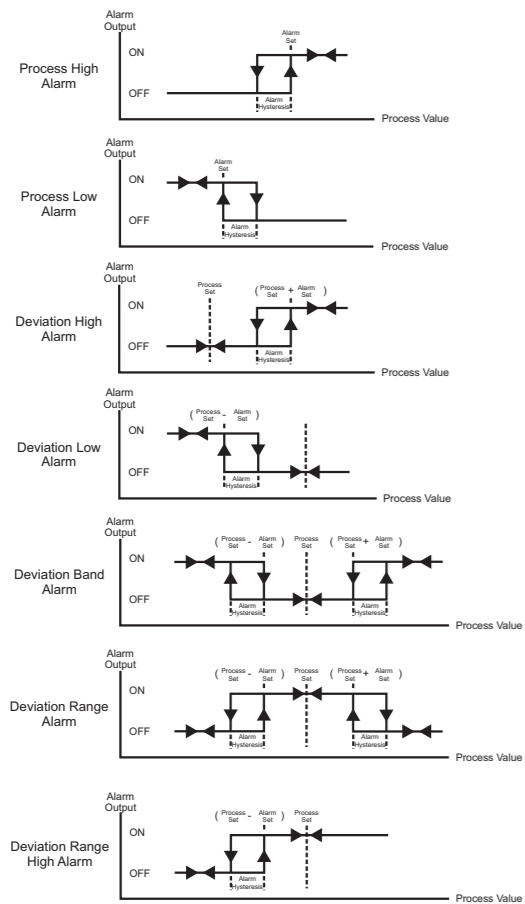

7. Specifications

Device Type : Temperature Controller
Housing & Mounting : 76mm x 34.5mm x 71mm plastic housing for panel Mounting. Panel cut-out is 71x29mm.
Protection Class : NEMA 4X (Ip65 at front, Ip20 at rear).
Weight : Approximately 0.20 Kg.
Environmental Ratings : Standard, indoor at an altitude of less than 2000 meters with none condensing humidity.
Storage / Operating Temperature : -30 °C to +80 °C / -20 °C to +70 °C
Storage / Operating Humidity : 90 % max. (None condensing)
Installation : Fixed installation
Overvoltage Category : II.
Pollution Degree : II, office or workplace, none conductive pollution
Operating Conditions : Continuous
Supply Voltage and Power : 230V~ (±%15) 50/60Hz - 1.5VA
 : 115V~ (±%15) 50/60Hz - 1.5VA
 : 24V~ (±%15) 50/60Hz - 1.5VA
 : 24V~ (±%15) 50/60Hz - 1.5VA
 : 10 - 30V--- 1.5W
Temperature Sensor Input : NTC, PTC, TC, RTD
NTC input type : NTC (10 kΩ @25 °C)
PTC input type : PTC (1000 Ω @25 °C)
Thermocouple input type : J, K (IEC584.1) (ITS 90)
Thermoresistance input type : PT-100, PT-1000 (IEC751) (ITS 90)
Accuracy : ± 1 % of full scale for thermoresistance
Cold Junction Compensation : Automatically ± 0.1°C / ± 1°C
Sensor Break Protection : Upscale
Sampling Cycle : 3 samples per second
Control Form : PID or ON / OFF
Relay Output : 16(8) A@250 V~ for Resistive load (Compressor Output) (Electrical life : 100.000 switching at full load)
 : 5 A@250 V~ for Resistive load (Alarm Output)
Optional SSR Drive Output : Maximum 20mA, Maximum 15V---
Display : 14 mm Red 4 digits LED Display
LED : S (Green), P (Green), °C (Yellow), °F (Yellow), Compressor Output (Red), Heating Output (Red)
Internal Buzzer : >83dB
Approvals : EAC, CE

13

14

8. Ordering Information

ESM-3720 (77x35 DIN Sizes)	A	B	C	D	E	FG	HI	U	V	W	Z
	0	/	01	00	/	1	0	0			
A Supply Voltage											
2	24V~ (±%15) 50/60Hz - 1.5VA										
3	24V~ (±%15) 50/60Hz - 1.5VA										
4	115V~ (±%15) 50/60Hz - 1.5VA										
5	230V~ (±%15) 50/60Hz - 1.5VA										
8	10 - 30 V ---										
BC Input Type	Scale(°C)										
05	J, Fe CuNi IEC584.1(ITS90)										0°C/32°F ; 800°C/1472°F
10	K, NiCr Ni IEC584.1(ITS90)										0°C/32°F ; 999°C/1830°F
11	PT 100, IEC751(ITS90)										-50°C/-58°F ; 400°C/752°F
09	PT 100, IEC751(ITS90)										-19.9°C/-4°F ; 99.9°C/212°F
14	PT 1000, IEC751(ITS90)										-50°C/-58°F ; 400°C/752°F
13	PT 1000, IEC751(ITS90)										-19.9°C/-4°F ; 99.9°C/212°F
12	PTC (Not-1)										-50°C/-58°F ; 150°C/302°F
18	NTC (Not-1)										-50°C/-58°F ; 100°C/212°F
E Control Output											
1	Relay Output (16(8) A@250 V~, at resistive Load, 1 NO)										
2	SSR Driver Output (Maximum 20m, Maximum 17V---)										
FG Alarm Output											
01	Relay Output (5 A@250 V~, at resistive Load, 1 NO)										
V Temp. Sensor which is given with ESM-3720											
0	None										
1	PTC-M6L40.K1.5 (PTC Air Probe 1.5 mt Silicon Cable)										
2	PTCS-M6L30.K1.5.1/8" (PTC Liquid Probe 1.5 mt Silicon Cable)										
3	NTC-M5L20.K1.5 (NTC Sensor, thermoplastic moulded with 1.5 m cable for cooling application)										
4	NTC-M6L50.K1.5 (NTC Sensor, stainless steel housing with 1.5 m cable for cooling application)										
9	Customer										

All order information of ESM-3720 Temperature Controller are given on the table at above. User may form appropriate device configuration from information and codes that at the table and convert it to the ordering codes. Firstly, supply voltage then other specifications must be determined. Please fill the order code blanks according to your needs.

Please contact us, if your needs are out of the standards.

Note-1: If input type is selected PTC or NTC (BC= 12, 18), Temperature sensor is given with the device. For this reason, if input type is selected as PTC, sensor type (V = 0, 1 or 2) or if input type is selected as NTC, sensor type (V = 0, 3 or 4) must be declared in ordering information.

15

9. Optional Accessories

1. RS-485 Module



RS-485 Communication Interface

2. PROKEY Programming Module



The device is programmed (Upload or Download) by using the parameters.

! ~ Vac,
 --- Vdc
 ~ Vdc or Vac can be applied

EMKO Thank you very much for your preference to use Emko Elektronik products, please visit our Your Technology Partner web page to download detailed user manual. www.emkoelektronik.com.tr

16

EMKO

ESM-3720 77x35 DIN Size Temperature Controller



ESM-3720 77 x 35 DIN Size Digital Temperature Controller

- 4 Digits Display
- NTC Input or PTC Input or J Type thermocouple Input or, K Type thermocouple Input or, 2-Wire PT-100 Input or, 2-Wire PT-1000 Input (Must be determined in order.)
- Adjustable temperature offset
- PID or ON/OFF temperature control
- Selectable heating or cooling function
- Selection of operation with hysteresis
- Adjustable temperature offset
- Set value low limit and set value high limit boundaries
- Operation selection of compressor operates continuously, stops or operates periodically in case of sensor defect
- Compressor protection delays
- Alarm parameters
- Adjustable internal buzzer according to sensor defect status.
- Password protection for programming section
- Installing parameters using Prokey
- Remote access, data collecting and controlling with Modbus RTU
- Having CE mark according to European Norms

Instruction Manual. ENG ESM-3720 01 V03 11/17

1. Preface

ESM-3720 series temperature controllers are designed for measuring and controlling temperature. They can be used in many applications with their On / Off control form, heating and cooling control form and easy-use properties. Some application fields which they are used are below:

Application Fields	Applications
Glass	Heating
Food	Baking Ovens
Plastic	Incubators
Petro-Chemistry	Storages
Textile,	Automotive Air Conditioning
Machine Production Industries Etc...	Etc...

1.1 Environmental Ratings

- Operating Temperature : -20 to 70 °C
- Max. Operating Humidity : 90% Rh (non-condensing)
- Altitude : Up to 2000 m.
- Forbidden Conditions: Corrosive atmosphere, Explosive atmosphere, Home applications (The unit is only for industrial applications)

1.2 General Specifications

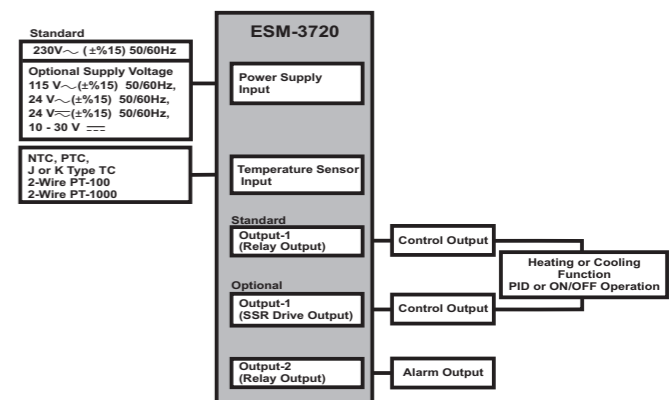

2

2. General Description

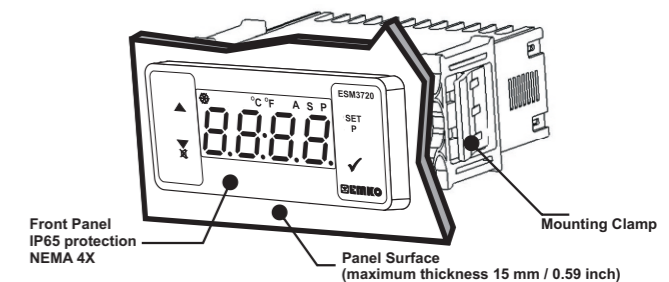

2.1 Front View and Dimensions of ESM-3720 Temperature Controller

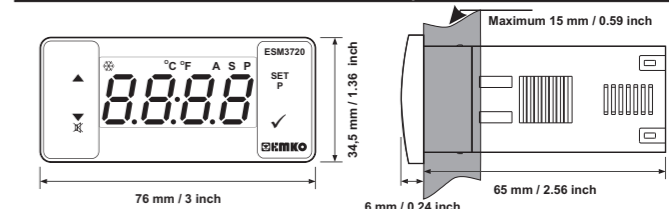

2.2 Panel Cut-Out

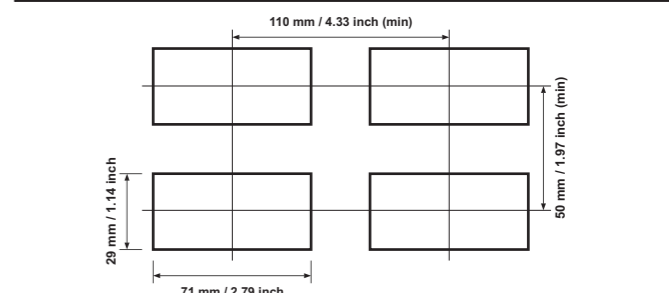

4

1.3 Installation

A visual inspection of this product for possible damage occurred during shipment is recommended before installation. It is your responsibility to ensure that qualified mechanical and electrical technicians install this product.

If there is danger of serious accident resulting from a failure or defect in this unit, power off the system and separate the electrical connection of the device from the system.

The unit is normally supplied without a power supply switch or a fuse. Use power switch and fuse as required.

Be sure to use the rated power supply voltage to protect the unit against damage and to prevent failure.

Keep the power off until all of the wiring is completed so that electric shock and trouble with the unit can be prevented.

Never attempt to disassemble, modify or repair this unit. Tampering with the unit may result in malfunction, electric shock or fire.

Do not use the unit in combustible or explosive gaseous atmospheres.

During putting equipment in hole on the metal panel while mechanical installation some metal burrs can cause injury on hands, you must be careful.

Montage of the product on a system must be done with it's fixing clamps. Do not do the montage of the device with inappropriate fixing clamp. Be sure that device will not fall while doing the montage.

It is your responsibility if this equipment is used in a manner not specified in this instruction manual.

1.4 Warranty

EMKO Elektronik warrants that the equipment delivered is free from defects in material and workmanship. This warranty is provided for a period of two years. The warranty period starts from the delivery date. This warranty is in force if duty and responsibilities which are determined in warranty document and instruction manual performs by the customer completely.

1.5 Maintenance

Repairs should only be performed by trained and specialized personnel. Cut power to the device before accessing internal parts. Do not clean the case with hydrocarbon-based solvents (Petrol, Trichlorethylene etc.). Use of these solvents can reduce the mechanical reliability of the device. Use a cloth dampened in ethyl alcohol or water to clean the external plastic case.

1.6 Manufacturer Company

Manufacturer Information:
 Emko Elektronik Sanayi ve Ticaret A.Ş.
 Demirtaş Organize Sanayi Bölgesi Karanfil Sk. No:6 16369 BURSA/TURKEY
 Phone : +90 224 261 1900
 Fax : +90 224 261 1912
Repair and maintenance service information:
 Emko Elektronik Sanayi ve Ticaret A.Ş.
 Demirtaş Organize Sanayi Bölgesi Karanfil Sk. No:6 16369 BURSA/TURKEY
 Phone : +90 224 261 1900
 Fax : +90 224 261 1912

3

2.3 Panel Mounting

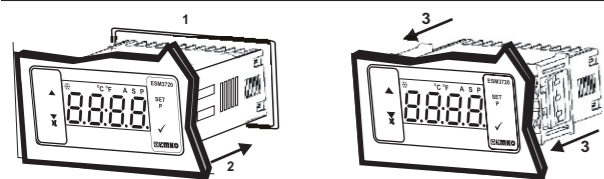

- 1-Before mounting the device in your panel, make sure that the cut-out is of the right size.
- 2-Insert the device through the cut-out. If the mounting clamps are on the unit, put them before inserting the unit to the panel.
- 3-Insert the mounting clamps to the fixing sockets that located left and right sides of device and make the unit completely immobile within the panel

2.4 Removing from the Panel

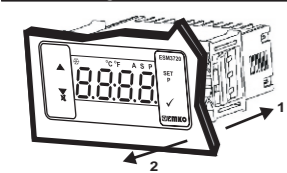

- 1-Pull mounting clamps from left and right fixing sockets.
 - 2-Pull the unit through the front side of the panel
- Before starting to remove the unit from panel, power off the unit and the related system.

3. Using Prokey

TO USE PROKEY, VALUE OF THE PrC PARAMETER MUST BE '0'. IF PrC=1 AND **▼** BUTTON IS PRESSED **[PrC]** MESSAGE WILL BE SHOWN. 10s. LATER DEVICE TURNS BACK TO THE MAIN OPERATION SCREEN OR YOU CAN PRESS SET BUTTON TO TURN BACK TO MAIN OPERATION SCREEN.

DOWNLOADING FROM DEVICE TO PROKEY

- 1.The device is programmed by using the parameters.
- 2.Energize the device then put in PROKEY and press **▼** button. **[PrC]** Message is shown on the display. When the loading has finished, **[PrC]** message is shown.
- 3.Press any button to turn back to main operation screen.
- 4.Remove the PROKEY.

NOTE: **[PrC]** message is shown when an error occurs while programming. If you want to reload, switch off the device and press **▼** button. If you want to quit, remove PROKEY and press **▼** button. The device will turn back to main operation screen.

DOWNLOADING FROM PROKEY TO DEVICE

- 1.Switch off the device.
- 2.Put in PROKEY then energize the device.
- 3.When the device is energized, the parameter values in PROKEY, start downloading to the device automatically. At first, **[PrC]** message is shown on the display, when loading has finished, **[PrC]** message is shown.
- 4.After 10 seconds device starts to operate with new parameter values.
- 5.Remove the PROKEY.

NOTE: **[PrC]** message is shown when an error occurs while programming. If you want to reload, switch off the device and put in PROKEY then energize the device. If you want to quit remove PROKEY and press **▼** button. The device will turn back to main operation screen.

4. Electrical Wiring Diagram

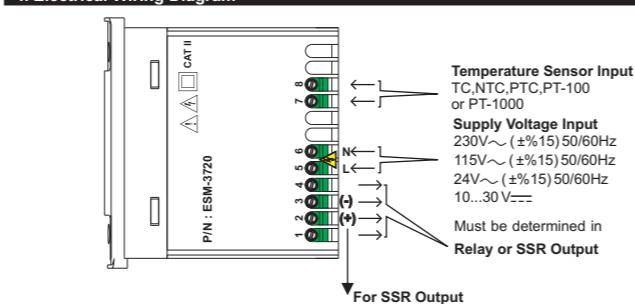

4.1 Supply Voltage Input Connection of the Device

Power Supply Connection Make sure that the power supply voltage is the same indicated on the instrument. Switch on the power supply only after that all the electrical connections have been completed. Supply voltage range must be determined in order. While installing the unit, supply voltage range must be controlled and appropriate supply voltage must be applied to the unit.

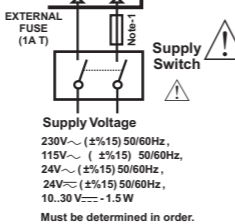

There is no power supply switch on the device. So a power supply switch must be added to the supply voltage input. Power switch must be two poled for separating phase and neutral, On/Off condition of power supply switch is very important in electrical connection. External fuse that on ~ power supply inputs must be on phase connection. External fuse that on = power supply inputs must be on (+) connection.

Note-1 : External fuse is recommended.

4.2 Device Label and Connection Diagram

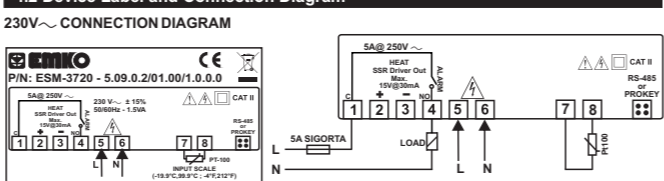

5.Front Panel Definition and Accessing to the Menus

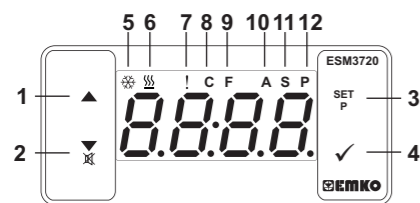

BUTTON DEFINITIONS

- 1. Increment Button :** It is used to increase the value in the Set screen and Programming mode.
- 2. Decrement, Silencing Buzzer and Downloading to Prokey Button :** It is used to decrease the value in the Set screen and Programming mode. It is used to silence the buzzer. If PrC=0, it is used to download from device to prokey.
- 3. Set Button :** In the main operation screen; if this button pressed, temperature set value will be displayed. Value can be changed using increment and decrement buttons. When Enter button pressed, value is saved and alarm set value is displayed. Value can be changed using increment and decrement buttons. When Enter button pressed, alarm set value is saved and returns back to main operating screen. To access the programming screen; in the main operation screen, press this button for 5 seconds. In the main operation screen; press ENTER button for 3 seconds to start auto tune operation.
- 4. Enter Button :** It is used to saving value in the Set screen and programming screen.

LED DEFINITIONS

- 5. Cooling led :** This led indicates that cooling control is selected and process output relay is active. If any of compressor protection time active, this led blinks.
- 6.Heating led :** This led indicates that heating control is selected and process output relay is active.
- 7.Alarm led :** This led indicates that alarm output relay is active.
- 8.Celcius led :** Indicates that device is in °C mode.
- 9.Fahrenheit led :** Indicates that device is in °F mode.
- 10.Auto Tune led :** Indicates that device is operating Auto Tune.
- 11.Set led :** Indicates that device is in Set value changing mode.
- 12.Program led :** Blinks in programming mode.

6. Changing and Saving Temperature Set Value

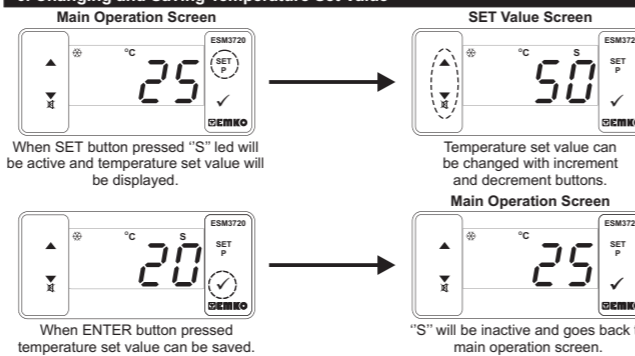

Temperature set value parameter (Default=50) MODBUS ADDRESS:40001 Temperature set value, can be programmed between minimum temperature set value [SuL] and maximum temperature set value [SuH].

6.1 Programming Mode Parameter List

- C-F** Temperature Unit Selection Parameter (Default = 0) MODBUS ADDRESS:40002
 - 0 °C selected.
 - 1 °F selected.
- Pnt** Decimal Separator Enabling Parameter (Default = 0) MODBUS ADDRESS:40003
 - 0 Disable.
 - 1 Enable.
- HCS** Operating Type Parameter (Default = 0) MODBUS ADDRESS:40004
 - 0 Heating
 - 1 Cooling
- P-o** Temperature Control Selection Parameter On/Off or PID (Default = 0) MODBUS ADRES:40005
 - 0 On - Off selected.
 - 1 PID selected.
- Aut** Auto Tune Selection Parameter (Default = 0) MODBUS ADRES:40006
 - 0 Device does not do(Limit cycle Tuning) operation.
 - 1 Device does operation
- P** PID- Proportional Control Parameter (Default = 5) MODBUS ADRES:40007
 - This parameter is entered as temperature.This parameter value is can be adjusted 0 to %100 of the device scale.
- I** PID-Integral Parameter(Default = 1000) MODBUS ADRES:40008
 - This parameter value can be adjust from 0 to 3600.

- d** PID-Derivative Parameter (Default = 250) MODBUS ADRES:40009
 - This parameter value can be adjust from 0 to 3600.
- t** PID-Period parameter(Default = 1) MODBUS ADRES:40010
 - This parameter value can be adjust from 0 to 50
- HSt** Hysteresis Parameter for Compressor Output (Default = 3) MODBUS ADDRESS:40011
 - from 1 to 20°C for NTC (-50°C, 100°C) or PTC (-50°C, 150°C) or J Type TC (0°C, 800°C) or K Type TC (0°C, 1000°C) or PT-100 Type (-50°C, 400°C) or PT-1000 Type (-50°C, 400°C) or PT-100 Type (-20°C, 100°C),
 - from 1 to 36°F for NTC (-58°F, 212°F) or PTC (-58°F, 302°F) or J Type TC (32°F, 1472°F) or K Type TC (32°F, 1830°F) or PT-100 Type (-58°F, 752°F) or PT-1000 Type (-58°F, 752°F) or PT-100 Type (-4°F, 212°F)
 - from 0.1 to 10.0°C for NTC(-50.0°C, 100.0°C) or PTC(-50.0°C, 150.0°C) or PT-100 (-19.9°C, 99.9°C),
 - from 0.1 to 18.0°F for NTC(-58.0°F, 212.0°F) or PTC(-58.0°F, 302.0°F) or PT-100 (-4.0°F, 212.0°F),
- SuL** Minimum Temperature Set Value Parameter (Default = Minimum Value of Device Scale) MODBUS ADDRESS:40012
 - Temperature set value can not be lower than this value.
 - This parameter value can be adjusted from minimum value of device scale to maximum temperature set value parameter [SuH]
- SuH** Maximum Temperature Set Value Parameter (Default = Maximum Value of Device Scale) MODBUS ADDRESS:40013
 - Temperature set value can not be bigger than this value.
 - This parameter value can be adjusted from minimum temperature set value parameter [SuL] to maximum value of the device scale
- oFt** Sensor Offset Parameter (Default = 0) MODBUS ADDRESS:40014
 - from -20 to 20 °C for NTC(-50°C, 100°C) or PTC(-50°C, 150°C) or J Type TC (0°C, 800°C) or K Type TC (0°C, 1000°C) or PT-100(-50°C, 400°C) or PT-1000 (-50°C, 150°C) or PT-100 (-20°C, 100°C),
 - from -36 to 36 °F for NTC(-58°F, 212°F) or PTC(-58°F, 302°F) or J Type TC (32°F, 1472°F) or K Type TC (32°F, 1830°F) or PT-100(-58°F, 752°F) or PT-1000(-58°F, 752°F) or PT-100(-4°F, 212°F),
 - from -10.0 to 10.0°C for NTC(-50.0°C, 100.0°C) or PTC(-50.0°C, 150.0°C) or PT-100 (-19.9°C, 99.9°C),
 - from -18.0 to 18.0°F for NTC(-58.0°F, 212.0°F) or PTC(-58.0°F, 302.0°F) or PT-100 (-4.0°F, 212.0°F),
- Pos** Compressor Start Delay at Power On Parameter (Default = 0) MODBUS ADDRESS:40015
 - When power is first applied to the device, compressor is on when this time delay is expired. It can be adjusted from 0 to 20 minutes.
- SPd** Compressor Stop-Start Delay Parameter (Default = 0) MODBUS ADRES:40016
 - When compressor is inactive, this time delay must be expired for activation of the compressor. It can be adjusted from 0 to 20 minutes.
- Std** Compressor Start-Start Delay Parameter (Default = 0) MODBUS ADRES:40017
 - This time delay must be expired between two activation of the compressor. It can be adjusted from 0 to 20 minutes.

- bUF** Buzzer Function Selection Parameter (Default = 0) MODBUS ADDRESS:40029
 - 0 Buzzer is inactive.
 - 1 Buzzer is active during sensor failures.
 - 2 Buzzer is active if an alarm occurs.
 - 3 Buzzer is active if an alarm occurs or sensor failures.
- bon** Buzzer is active during this time (Default = -) MODBUS ADDRESS:40030
 - If buzzer function selection parameter value [bUF]=0, this parameter can not be observed. Buzzer stays active during this time. It can be adjusted from 1 to 99 minutes
 - When this parameter is 1, if decrement button is pressed, [-] is observed. In this condition buzzer is active till buzzer silence button is pressed.
- PrC** Communication Mode Selection Parameter (Default = 0) MODBUS ADDRESS:40031
 - 0 PROKEY communication selected.
 - 1 Rs485 communication selected.
- SAd** Slave ID Parameter (Default = 1) MODBUS ADDRESS=40032
 - Device communication address parameter (1 to 247).
- PAS** Programming Section Accessing Password (Default = 0) MODBUS ADDRESS:40033
 - It is used for accessing to the programming section. It can be adjusted from 0 to 9999. If it is selected 0, password will not be asked.

6.2 Modbus Addresses of Device Status Parameters (Read Input Register)

MODBUS ADDRESS:	Temperature Value
30001	Temperature Value
30002	Empty
30003	Led Status : 0.bit °C Led, 1.bit °F Led, 3.bit *Auto Tune Led, 5.bit Heating Led, 6.bit Compressor Led, 7.bit Alarm Led, 13.bit Program Led, 14.bit Set Led
30004	Device Status : 0.bit Alarm Status 1.bit Buzzer Status 2.bit Sensor Break Status
30005	Output Status 0.bit Control Output 1.bit Alarm Output
30006	Device Type and Device Version

6.3 Failure Messages in ESM-3720 Temperature Controller

Screen Blinking
Sensor failure. Sensor connection is wrong or there is no sensor connection. If buzzer function selection parameter [bUF] is 1, internal buzzer starts to operate.

- PdF** Sensor Defect Parameter (Default = 0) MODBUS ADRES:40018
 - 0 Compressor is OFF in case of sensor defect.
 - 1 Compressor is ON in case of sensor defect.
 - 2 Compressor operates periodically according to [P-on] and [P-oF] Time periods in case of sensor defect.
 - P-on** Compressor is active during this time period in case of probe defect (Default = 0) MODBUS ADRES:40019
 - If probe defect parameter [PdF] is 2, then this parameter is observed. It can be adjusted from 0 to 99 minutes.
 - P-oF** Compressor is inactive during this time period in case of probe defect (Default = 0) MODBUS ADRES:40020
 - If probe defect parameter [PdF] is 2, then this parameter is observed. It can be adjusted from 0 to 99 minutes.
 - ALS** Temperature Alarm Function Selection Parameter (Default = 1) MODBUS ADRES:40021
 - 0 Alarm function is inactive.
 - 1 Process High alarm selected.
 - 2 Process Low alarm selected.
 - 3 Deviation High alarm selected.
 - 4 Deviation Low alarm selected.
 - 5 Deviation Band alarm selected.
 - 6 Deviation Range alarm selected.
 - 7 Deviation Range High alarm selected.
- Note: If this parameter is select 0, [ASL], [ALH], [AuL], [AuH], [P-on], [P-oF] and [Pd] parameters will be not observed
- ASL** Temperature Alarm Set Parameter (Default = 80) MODBUS ADRES:40022
 - This parameter value can be programmed between temperature minimum alarm set [AuL] parameter and temperature alarm set maximum [AuH] parameter.
 - ALH** Temperature Alarm Hysteresis Parameter (Default = 3) MODBUS ADRES:40023
 - This parameter value can be adjusted form 0.1 to %50 of the device scale if Pnt parameter is 1, 1 to %50 of the device scale if Pnt parameter is 0.
 - AuL** Temperature Minimum Alarm Parameter (Default = Minimum Value of Device Scale) MODBUS ADRES:40024
 - If temperature alarm is active, this parameter value can be adjusted from minimum value of device scale to temperature alarm set maximum parameter value [AuH].
 - AuH** Temperature Alarm Maximum Parameter (Default = Maximum Value of Device Scale) MODBUS ADRES:40025
 - If temperature alarm is active, this parameter value can be adjusted from temperature alarm set value parameter [AuL] to maximum value of the device scale.
 - P-on** Temperature Alarm On Delay Time Parameter (Default = 0) MODBUS ADDRESS:40026
 - Temperature alarm on delay time can be defined with this parameter. It can be adjusted from 0 to 99 minutes.
 - P-oF** Temperature Alarm Off Delay Time Parameter (Default = 0) MODBUS ADDRESS:40027
 - Temperature alarm off delay time can be defined with this parameter. It can be adjusted from 0 to 99 minutes. If it is higher than 99 [LCH] is seen on the screen and alarm latching output is selected. In alarm latching output mode, in order to make passive alarm output, press DECREMENT button at main screen.
 - APd** Temperature Alarm Delay After Power On Parameter (Default = 0) MODBUS ADRES:40028
 - When power is first applied to the device, this time delay must be expired for activation of temperature alarm. It can be adjusted from 0 to 99 minutes.

6.4 Entering To The Programming Mode, Changing and Saving Parameter

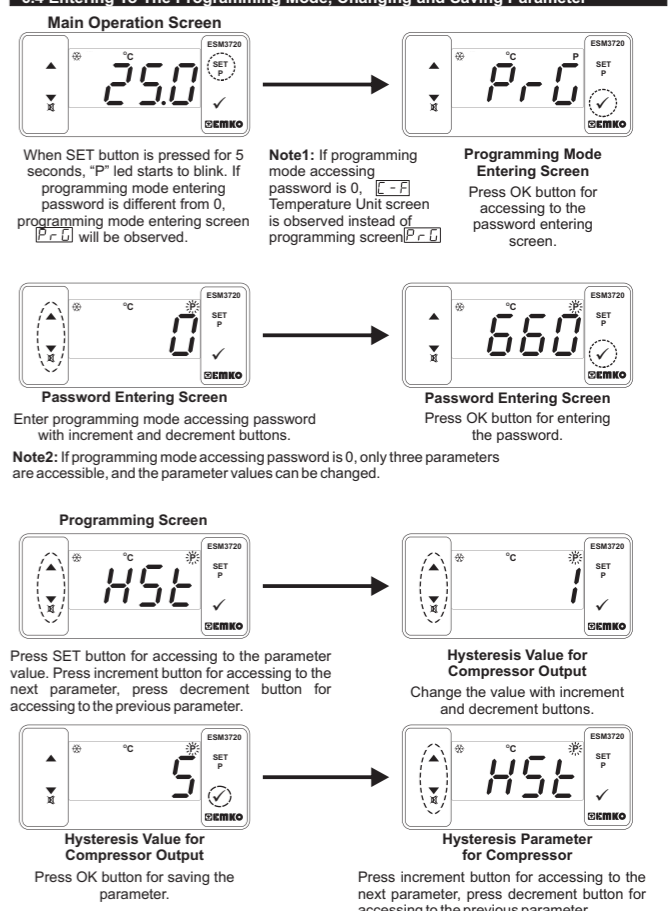

If no operation is performed in programming mode for 20 seconds, device turns to main operation screen automatically.