



***EZM-4435 48 x 48 DIN 1/16
Universal Input Programmable Timer***

- 6 digits Process (PV) and 6 digits Set (SV) Value Display
- Operation with 1 Set Value
- Reset , Pause and Start Inputs
- Operation with Automatic and Manual Reset
- NPN/PNP Type Operation
- Programmable Time Bases (Second, Minute, Hour)

ABOUT INSTRUCTION MANUAL

Instruction manual of EZM-4435 Programmable Timer consists of two main sections. Explanation of these sections are below. Also, there are other sections which include order information and technical specifications of the device. All titles and page numbers in instruction manual are in “**CONTENTS**” section. User can reach to any title with section number.

Installation:

In this section, physical dimensions of the device, panel mounting, electrical wiring, module mounting in the device, physical and electrical installation of the device to the system are explained.

Operation and Parameters:

In this section, user interface of the device, how to access to the parameters, description of parameters are explained.

Also in these sections, there are warnings to prevent serious injury while doing the physical and electrical mounting or using the device.

Explanation of the symbols which are used in these sections are given below.



This symbol is used for safety warnings. User must pay attention to these warnings.



This symbol is used to determine the dangerous situations as a result of an electric shock. User must pay attention to these warnings definitely.



This symbol is used to determine the important notes about functions and usage of the device.

CONTENTS

1.PREFACE	Page 5
1.1 GENERAL SPECIFICATIONS	
1.2 ORDERING INFORMATION	
1.3 WARRANTY	
1.4 MAINTENANCE	
2.INSTALLATION	Page 7
2.1 GENERAL DESCRIPTION	
2.2 DIMENSIONS	
2.3 PANEL CUT-OUT	
2.4 ENVIRONMENTAL RATINGS	
2.5 PANEL MOUNTING	
2.6 INSTALLATION FIXING CLAMP	
2.7 REMOVING FROM THE PANEL	
3.ELECTRICAL WIRINGS	Page 12
3.1 TERMINAL LAYOUT AND CONNECTION INSTRUCTION	
3.2 ELECTRICAL WIRING DIAGRAM	
3.3 VIEW OF DEVICE LABEL	
3.4 CONNECTION OF DEVICE SUPPLY VOLTAGE INPUT	
3.5 INPUT CONNECTION	
3.5.1 PROXIMITY CONNECTION	
3.5.2 SWITCH CONNECTION	
3.6 RELAY OUTPUT WIRING DIAGRAM	
3.7 GALVANIC ISOLATION TEST VALUES OF EZM-4435 PROGRAMMABLE TIMER	
4.DEFINITION OF FRONT PANEL AND ACCESSING TO THE SET PARAMETERS	Page 19
4.1 DEFINITION OF FRONT PANEL	
4.2 POWER ON OBSERVATION OF EZM - 4435 PROGRAMMABLE TIMER AND SOFTWARE REVISION ON THE DISPLAY	
4.3 ADJUSTMENT OF SET VALUE	
4.4 RESETTING COUNT VALUE	
4.5 ACCESSING TO THE PROGRAM PARAMETERS	
5.PROGRAM PARAMETERS	Page 27
6.FAILURE MESSAGES IN EZM-4435 PROGRAMMABLE TIMER	Page 41
7.SPECIFICATIONS	Page 43
8.OTHER INFORMATIONS	Page 43

EU DECLARATION OF CONFORMITY

Manufacturer's Name : EMKO ELEKTRONIK A.S.
Manufacturer's Address : DOSAB, Karanfil Sk., No:6,
16369 Bursa, TURKEY

The manufacturer hereby declares that the product:

Product Name : Programmable Timer
Type Number : EZM-4435
Product Category : Electrical equipment for measurement, control and laboratory use

Conforms to the following directives :

2006 / 95 / EC The Low Voltage Directive

2004 / 108 / EC The Electromagnetic Compatibility Directive

has been designed and manufactured to the following specifications:

EN 61000-6-4:2007 EMC Generic Emission Standard for Industrial Environments

EN 61000-6-2:2005 EMC Generic Immunity Standard for Industrial Environments

EN 61010-1:2001 Safety Requirements for electrical equipment for measurement, control and laboratory use

When and Where Issued

16th October 2009

Bursa-TURKEY

Authorized Signature

Name : Serpil YAKIN

Position : Quality Manager

1.Preface

EZM Series Programmable Timer can be used in package machines, production and quality control rollers, and can be adapted easily to all mechanical construction and automation system.

Some application fields which they are used are below:

Application Field

Package machines,
Quality Control rollers,
Filling Systems,
Tool Benchs,
Building Automation.
Production bands

1.1 General Specifications

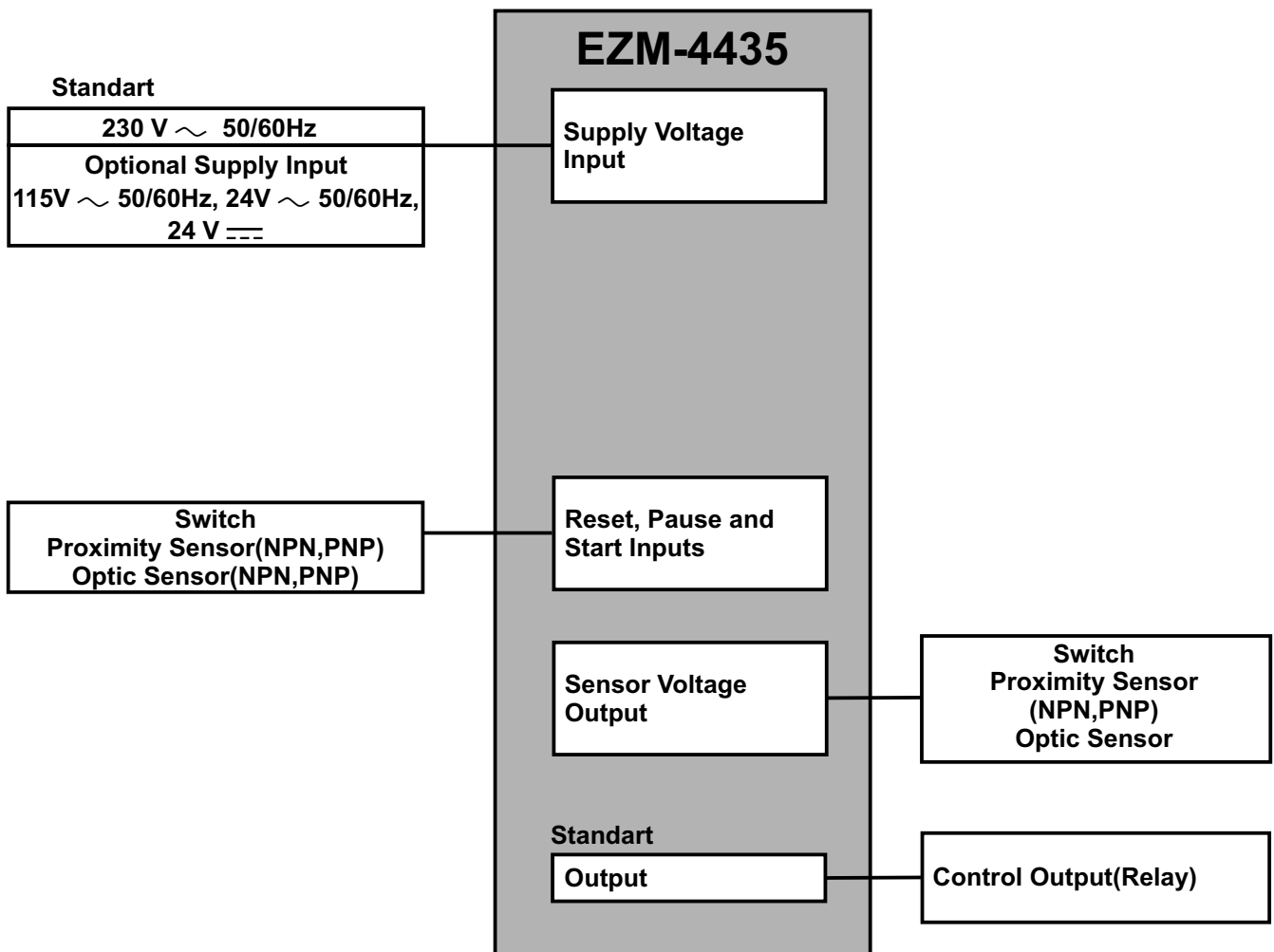

1.2 Ordering Information

EZM-4435 (48x48 DIN 1/16)	A	BC	D	E	/	FG	HI	/	U	V	W	Z
		00	0	1	/	00	00	/	0	0	0	0

A Supply Voltage

2	24 V \sim (-%15;+%10) 50/60Hz	24 V \equiv (-%15;+%10)
3	24 V \sim (-%15;+%10) 50/60Hz	
4	115 V \sim (-%15;+%10) 50/60Hz	
5	230V \sim (-%15;+%10) 50/60Hz	
9	Customer (Maximum 240V \sim (-%15;+%10))50/60Hz	

E Output-1

1	Relay Output (5A @ 250 V \sim) Resistive Load
---	--

All order information of EZM-4435 Programmable Timer are given on the table at left. User may form appropriate device configuration from information and codes that at the table and convert it to the ordering codes.

Supply voltage must be determined for your system.

Please fill the order code blanks according to your needs.

Please contact us, if your needs are out of the standards.



\sim Symbol means Vac
 \equiv Symbol means Vdc

1.3 Warranty

EMKO Elektronik warrants that the equipment delivered is free from defects in material and workmanship. This warranty is provided for a period of two years. The warranty period starts from the delivery date. This warranty is in force if duty and responsibilities which are determined in warranty document and instruction manual performs by the customer completely.

1.4 Maintenance

Repairs should only be performed by trained and specialized personnel. Cut power to the device before accessing internal parts.

Do not clean the case with hydrocarbon-based solvents (Petrol, Trichlorethylene etc.). Use of these solvents can reduce the mechanical reliability of the device. Use a cloth dampened in ethyl alcohol or water to clean the external plastic case.

2.Installation



Before beginning installation of this product, please read the instruction manual and warnings below carefully.

In package ,

- One piece unit
- Two pieces mounting clamps
- One piece instruction manual

A visual inspection of this product for possible damage occurred during shipment is recommended before installation. It is your responsibility to ensure that qualified mechanical and electrical technicians install this product.

If there is danger of serious accident resulting from a failure or defect in this unit, power off the system and separate the electrical connection of the device from the system.

The unit is normally supplied without a power switch or a fuse. Use power switch and fuse as required.

Be sure to use the rated power supply voltage to protect the unit against damage and to prevent failure.

Keep the power off until all of the wiring is completed so that electric shock and trouble with the unit can be prevented.

Never attempt to disassemble, modify or repair this unit. Tampering with the unit may results in malfunction, electric shock or fire.

Do not use the unit in combustible or explosive gaseous atmospheres.

During the equipment is putted in hole on the metal panel while mechanical installation some metal burrs can cause injury on hands, you must be careful.

Montage of the product on a system must be done with it's fixing clamps. Do not do the montage of the device with inappropriate fixing clamp. Be sure that device will not fall while doing the montage.

It is your responsibility if this equipment is used in a manner not specified in this instruction manual.

2.1 General Description

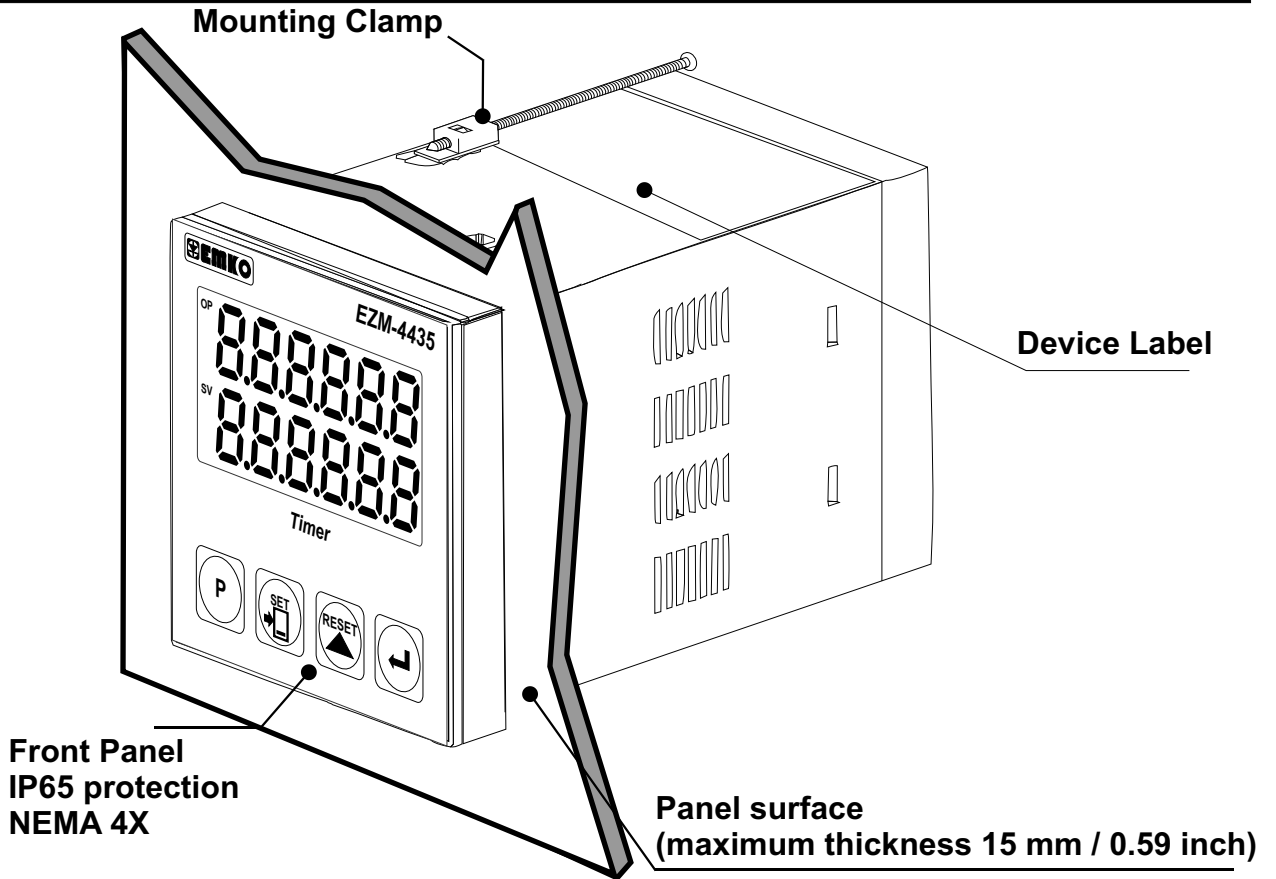

2.2 Dimensions

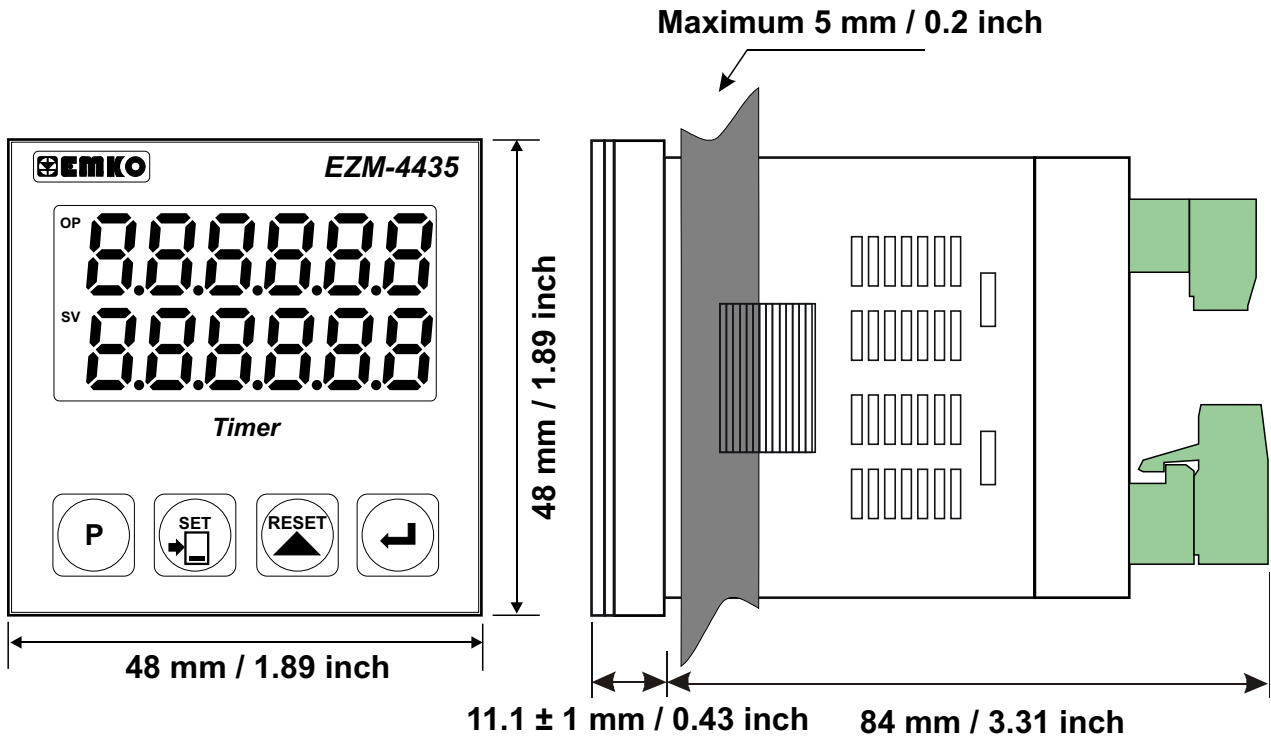

2.3 Panel Cut-out

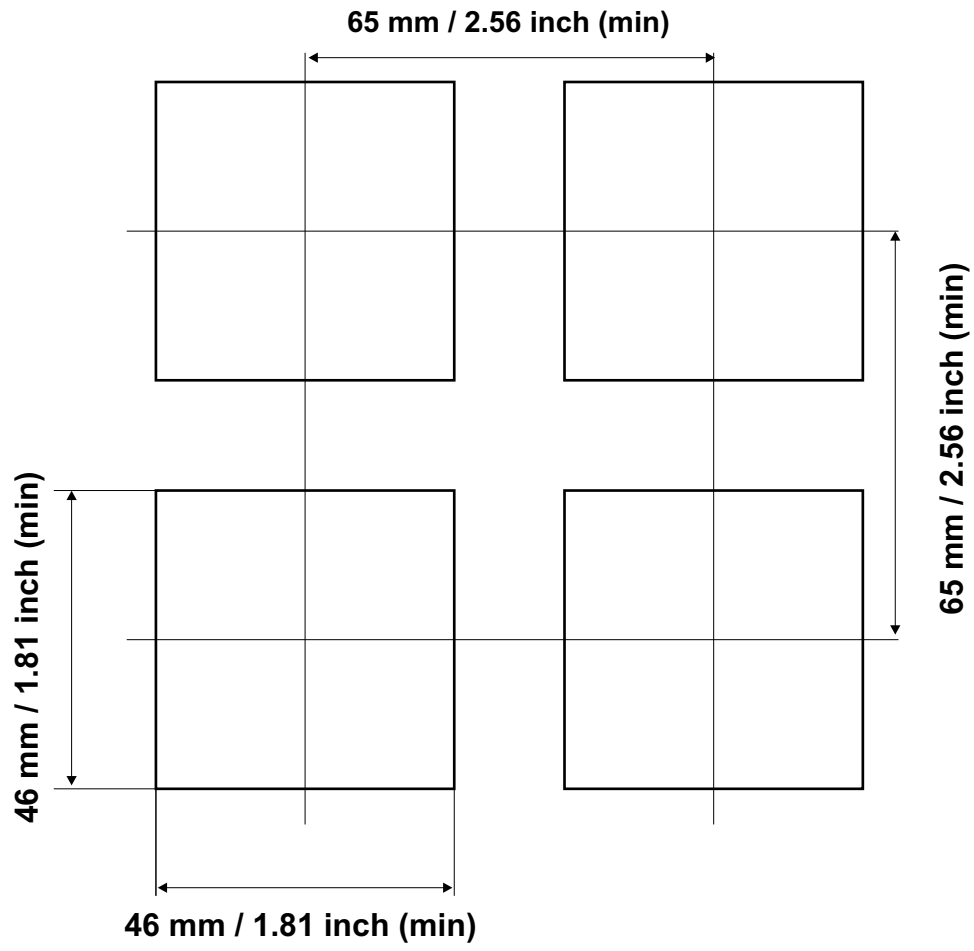

2.4 Environmental Ratings

Operating Conditions



Operating Temperature : 0 to 50 °C



Max. Operating Humidity : 90% Rh (non-condensing)



Altitude : Up to 2000m.



Forbidden Conditions:

Corrosive atmosphere

Explosive atmosphere

Home applications (The unit is only for industrial applications)

2.5 Panel Mounting

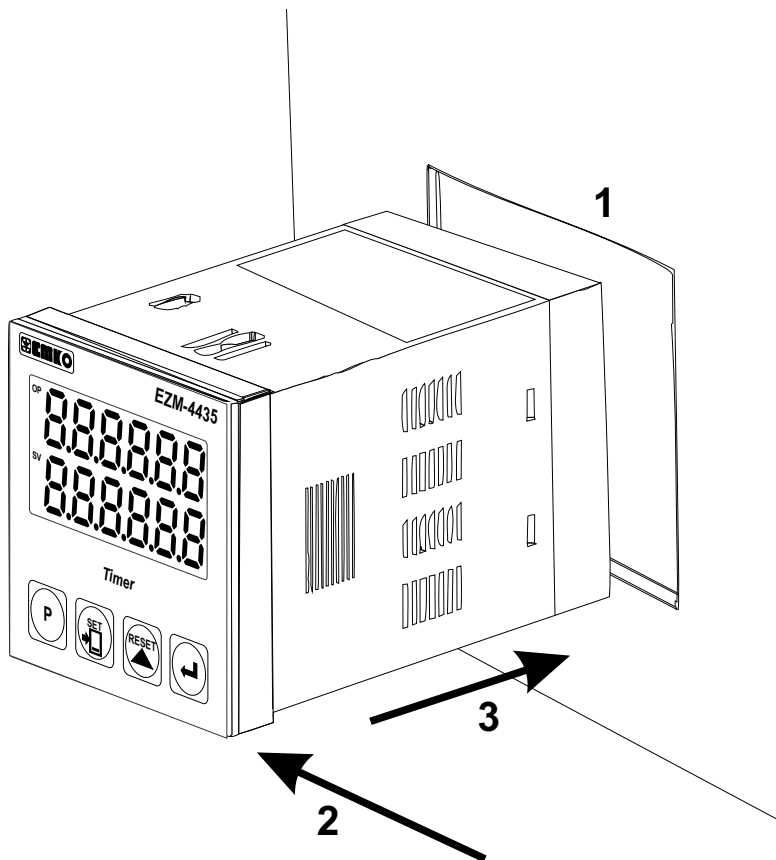

1-Before mounting the device in your panel, make sure that the cut-out is the right size.

2-Check front panel gasket position

3-Insert the device through the cut-out. If the mounting clamps are on the unit, put out them before inserting the unit to the panel.



During installation into a metal panel, care should be taken to avoid injury from metal burrs which might be present. The equipment can loosen from vibration and become dislodged if installation parts are not properly tightened. These precautions for the safety of the person who does the panel mounting.

2.6 Installation Fixing Clamp

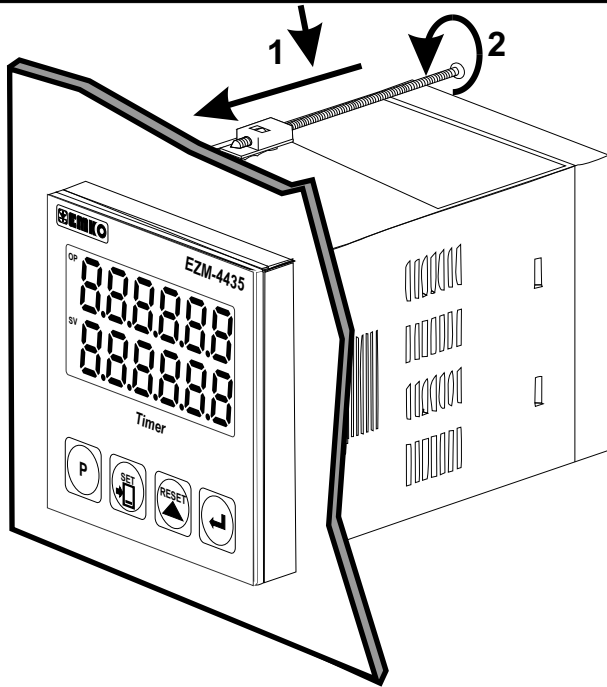

The unit is designed for panel mounting.

1-Insert the unit in the panel cut-out from the front side.

2- Insert the mounting clamps to the holes that located top and bottom sides of device and screw up the fixing screws until the unit completely immobile within the panel



Montage of the unit to a system must be done with it's own fixing clamps. Do not do the montage of the device with inappropriate fixing clamps. Be sure that device will not fall while doing the montage.

2.7 Removing from the Panel



Before starting to remove the unit from panel, power off the unit and the related system.

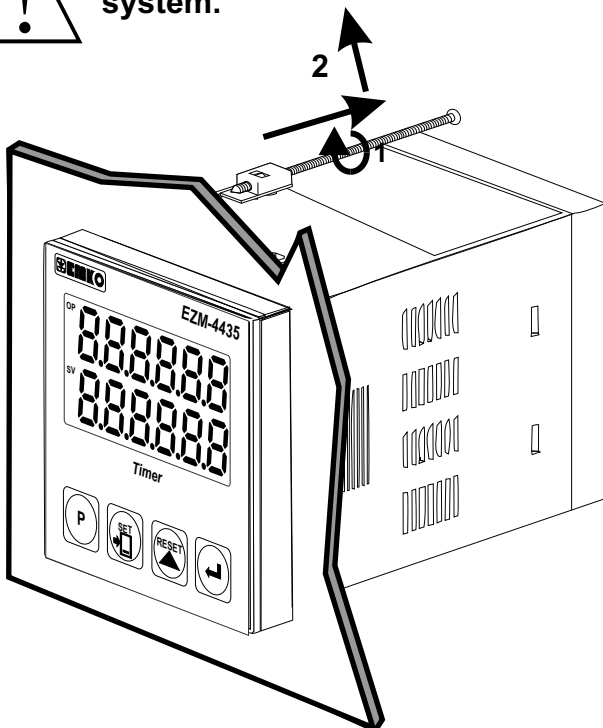

1-Loosen the screws.

2-Pull mounting clamps from top and bottom fixing sockets.

3-Pull the unit through the front side of the panel

3. Electrical Wirings



You must ensure that the device is correctly configured for your application. Incorrect configuration could result in damage to the process being controlled, and/or personal injury. It is your responsibility, as the installer, to ensure that the configuration is correct.

Parameters of the device has factory default values. These parameters must be set according to the system's needs.



Only qualified personnel and technicians should work on this equipment. This equipment contains internal circuits with voltage dangerous to human life. There is severe danger for human life in the case of unauthorized intervention.



Be sure to use the rated power supply voltage to protect the unit against damage and to prevent failure.



Keep the power off until all of the wiring is completed so that electric shock and trouble with the unit can be prevented.

3.1 Terminal Layout and Connection Instructions

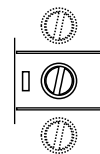
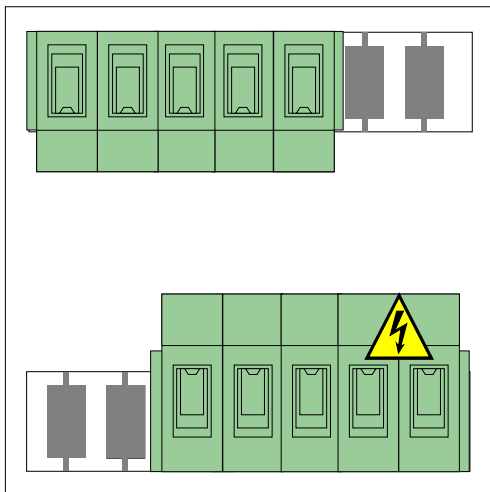

Max. 2.5mm / 0.098 inch
Wire Size:
14AWG/1mm²
Solid / Stranded

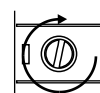

Torque
0,5Nm



Screw driver
0,8 x3mm

3.2 Electrical Wiring Diagram



Electrical wiring of the device must be the same as 'Electrical Wiring Diagram' below to prevent damage to the process being controlled and personnel injury.

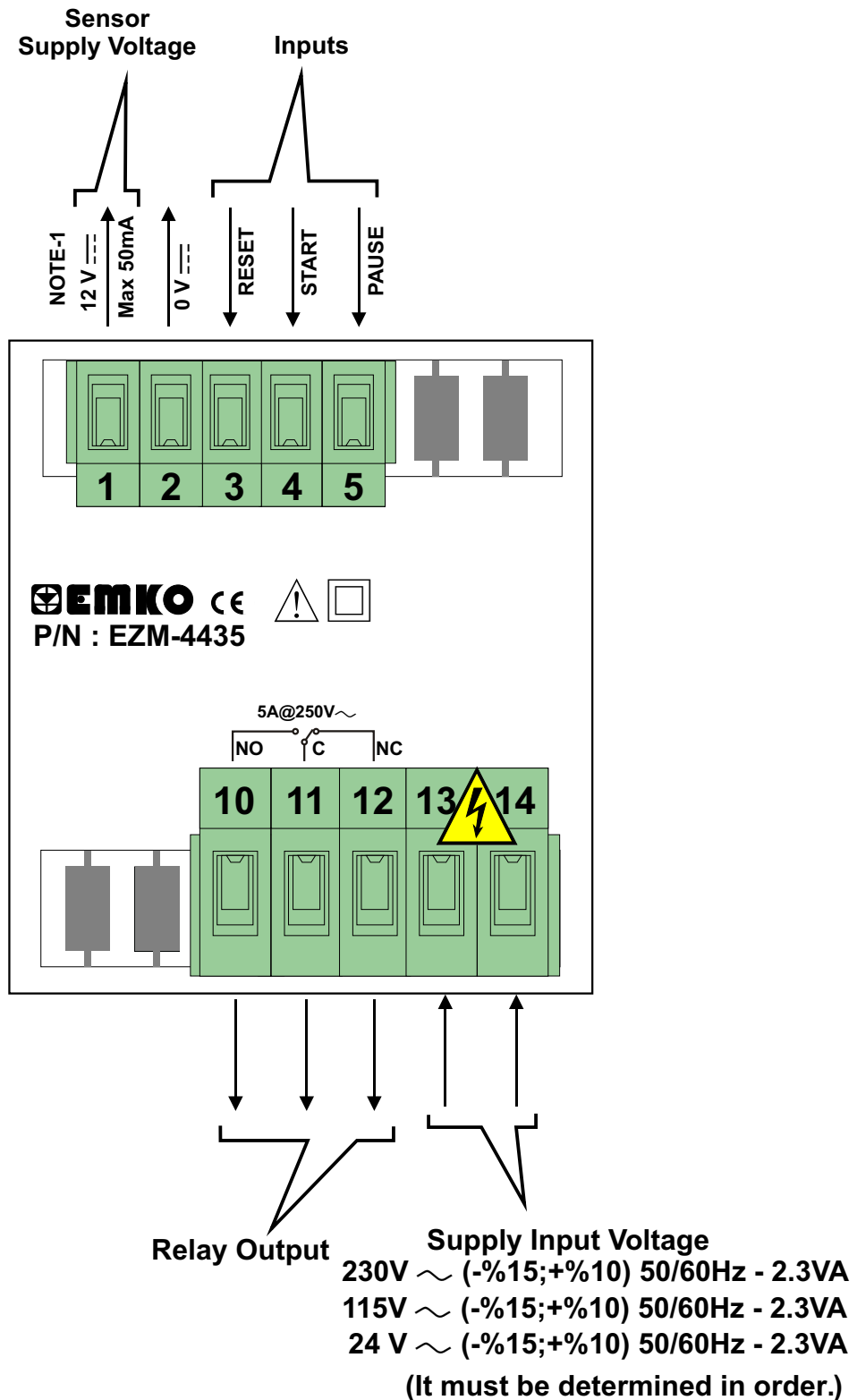

NOTE-1 : Sensor supply voltage: 12V $\overline{\text{---}}$ \pm 40%, 50 mA maximum with short circuit protection

3.3 View of Device Label

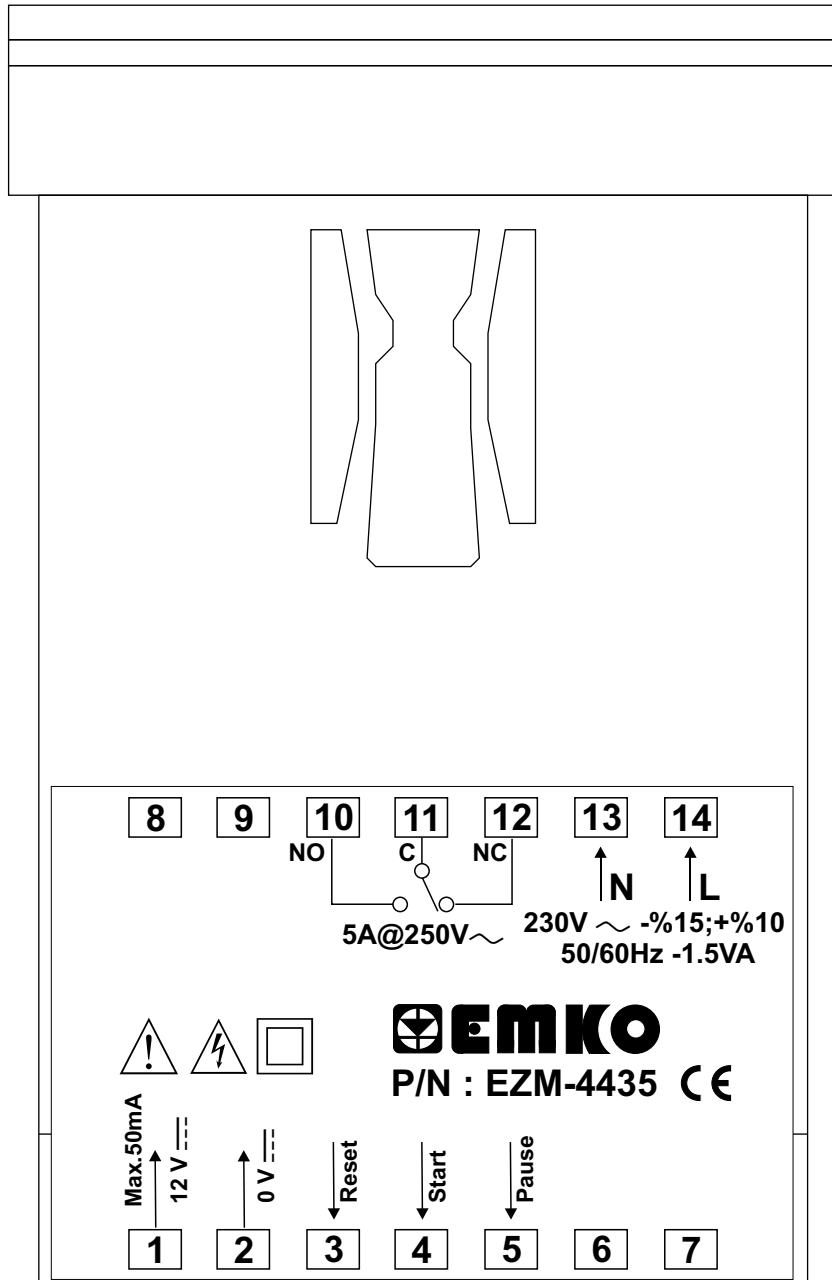

3.4 Connection of Device Supply Voltage Input

Connection of Universal Supply Voltage Input

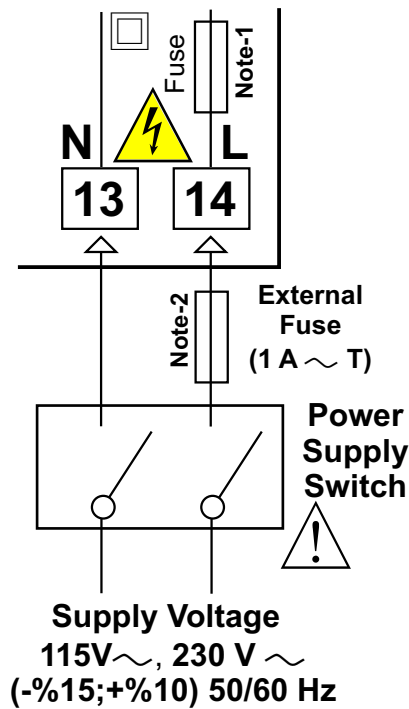

Connection of Universal Supply Voltage Input

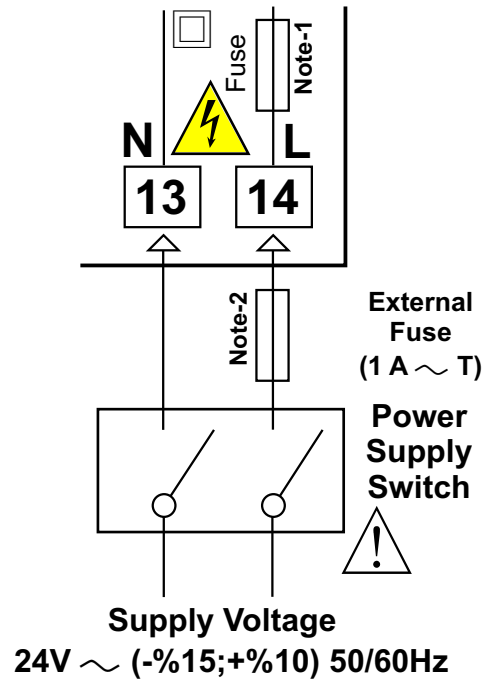

Note-1 :

There is internal 33 R fusible flameproof resistor in 115V \sim 50/60 Hz and 230V \sim 50/60 Hz
There is internal 4R7 fusible flameproof resistor in 24V \sim 50/60Hz

Note-2 : External fuse is recommended



Make sure that the power supply voltage is the same indicated on the instrument.

Switch on the power supply only after that all the electrical connections have been completed.

Supply voltage range must be determined in order. While installing the unit, supply voltage range must be controlled and appropriate supply voltage must be applied to the unit. Controlling prevents damages in unit and system and possible accidents as a result of incorrect supply voltage.



There is no power supply switch on the device. So a power supply switch must be added to the supply voltage input. In accordance with the safety regulations, the power supply switch shall bring the identification of the relevant instrument. Power supply switch shall be easily accessible by the user.

Power switch must be two poled for seperating phase and neutral. On/Off condition of power switch is very important in electrical connection. On/Off condition of power switch must be signed for preventing the wrong connection.

If an external fuse is used, it must be on phase connection in \sim supply input.

3.5 Input Connection

3.5.1 Proximity Connection

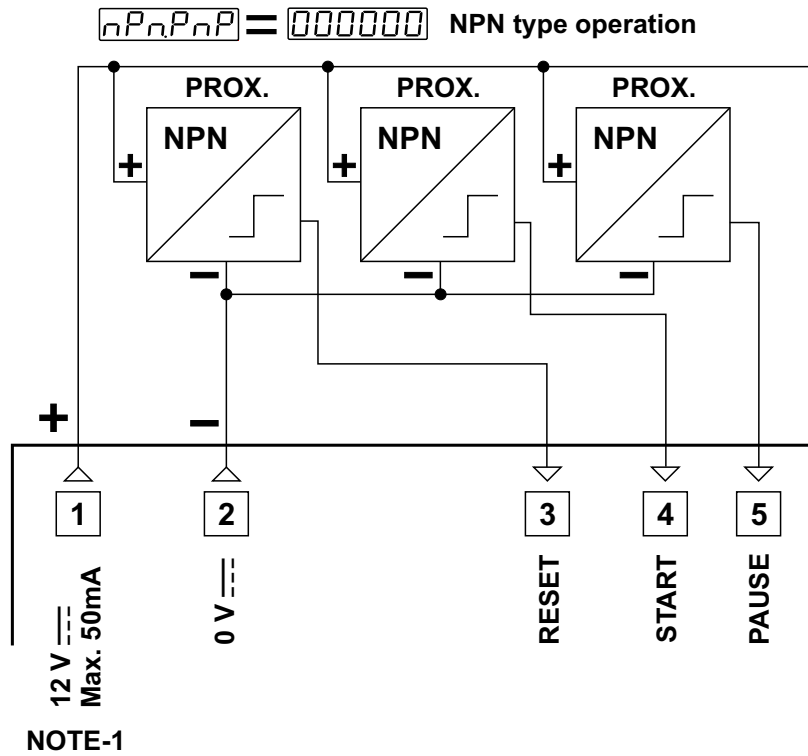
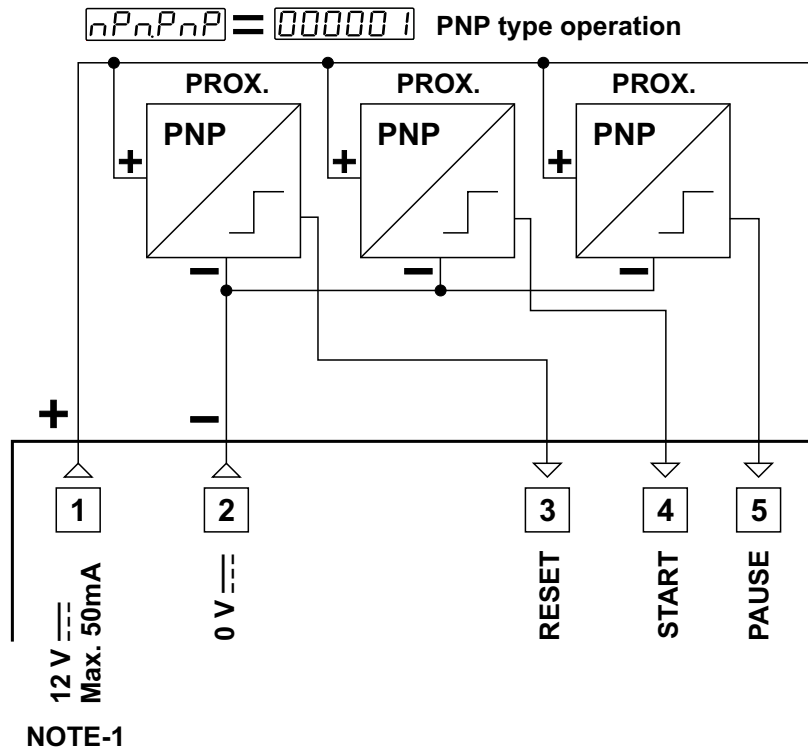

NOTE-1 : Sensor supply voltage: $12V_{\pm 40\%}$, 50 mA maximum with short circuit protection

3.5.2 Switch Connection

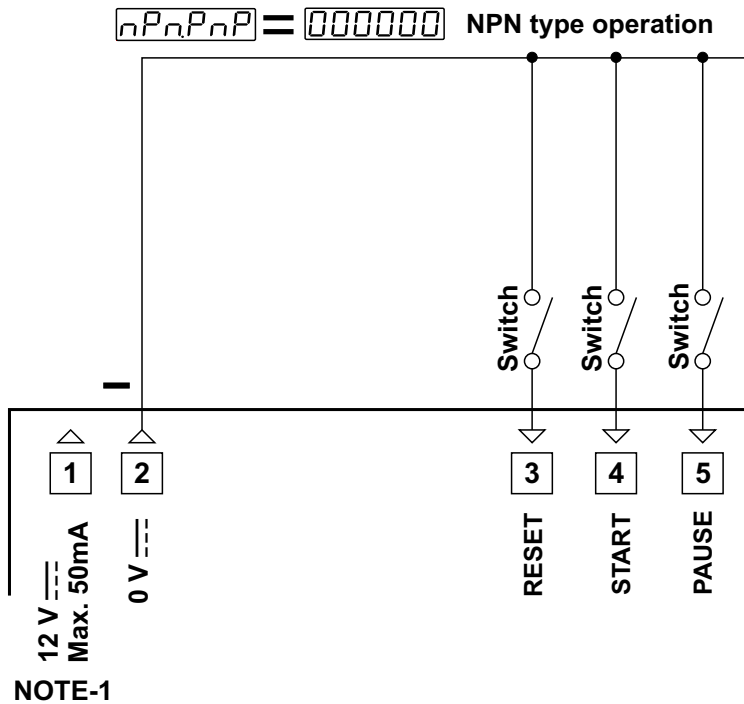
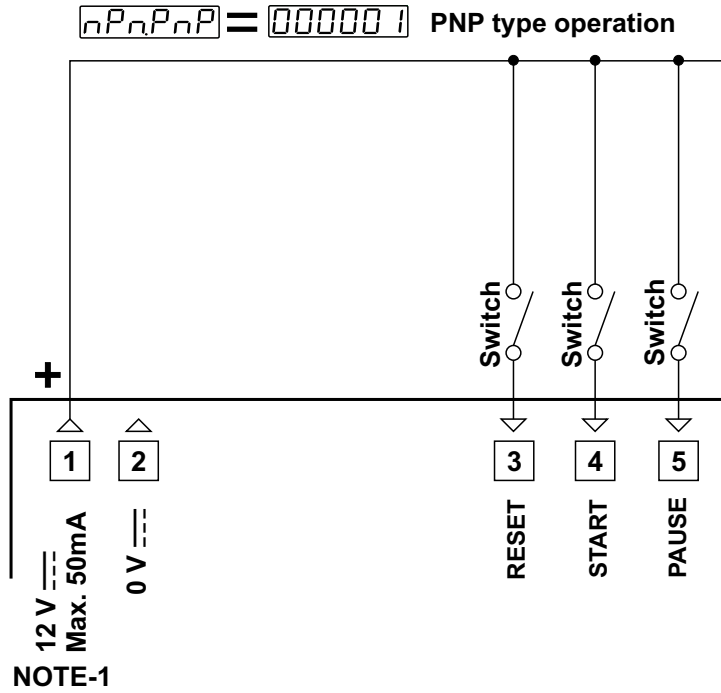

NOTE-1 : Sensor supply voltage: 12V \pm 40%, 50 mA maximum with short circuit protection

3.6 Relay Output Wiring Diagram

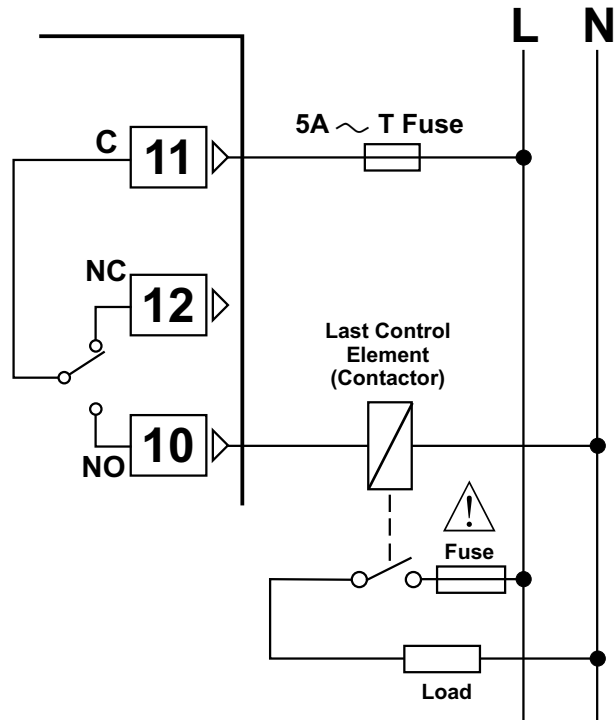

Fuses must be selected according to the applications.

3.7 Galvanic Isolation Test Results of EZM-4435 Programmable Timer

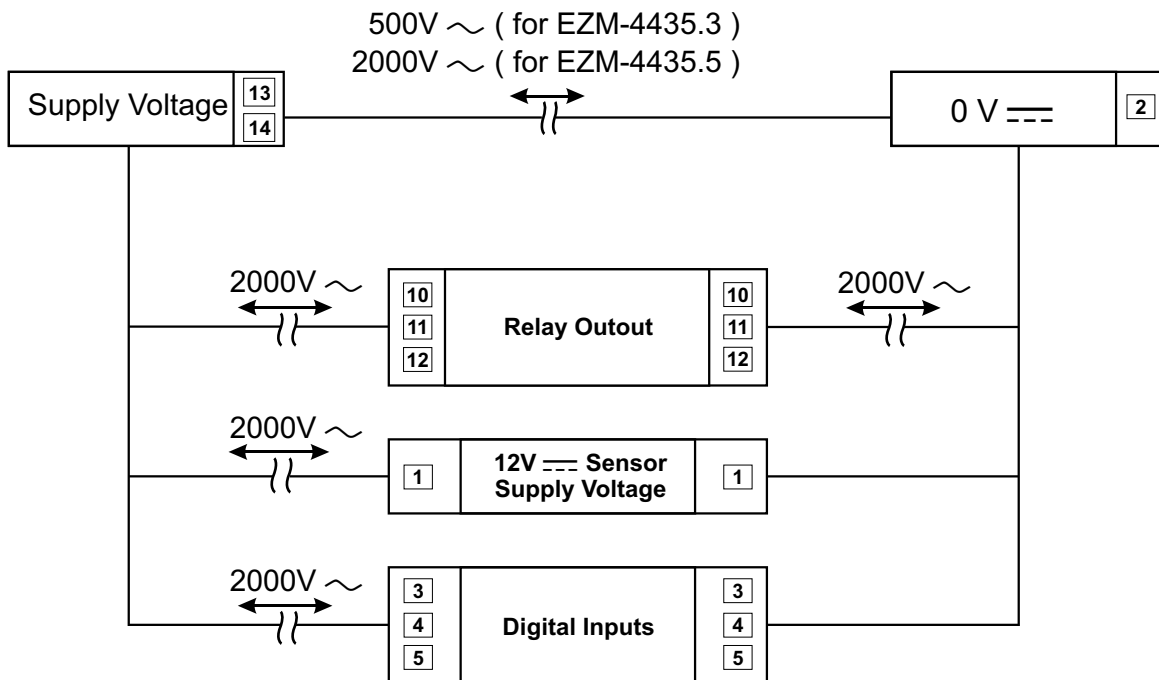

4. Definition of Front Panel and Accessing to the Set Parameters

4.1 Definition of Front Panel

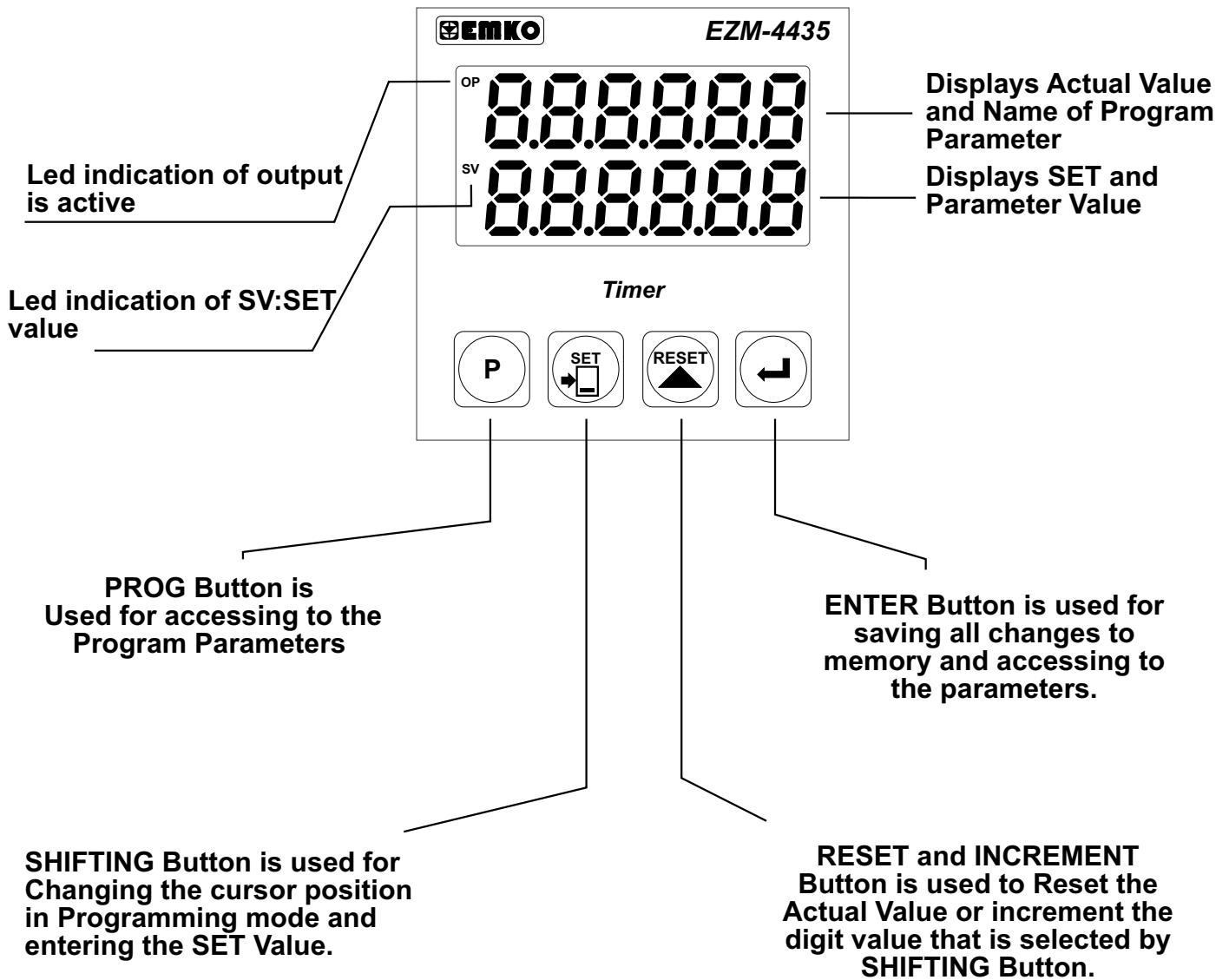

4.2 Power On Observation of EZM - 4435 Programmable Timer and Software Revision on the Display

When power is applied to the device, software revision number of the controller is momentarily illuminated on actual value display. Then operation screen is observed.

When power on, view of the screen is shown below:

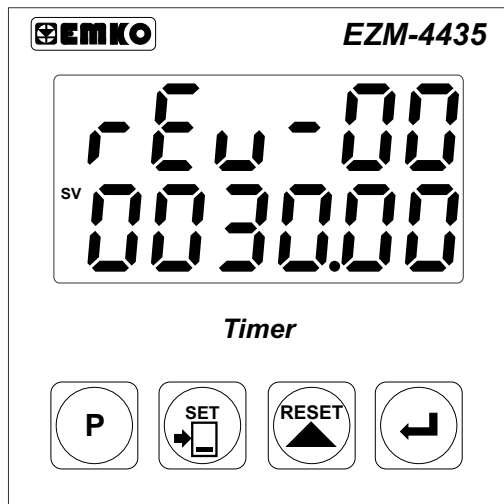
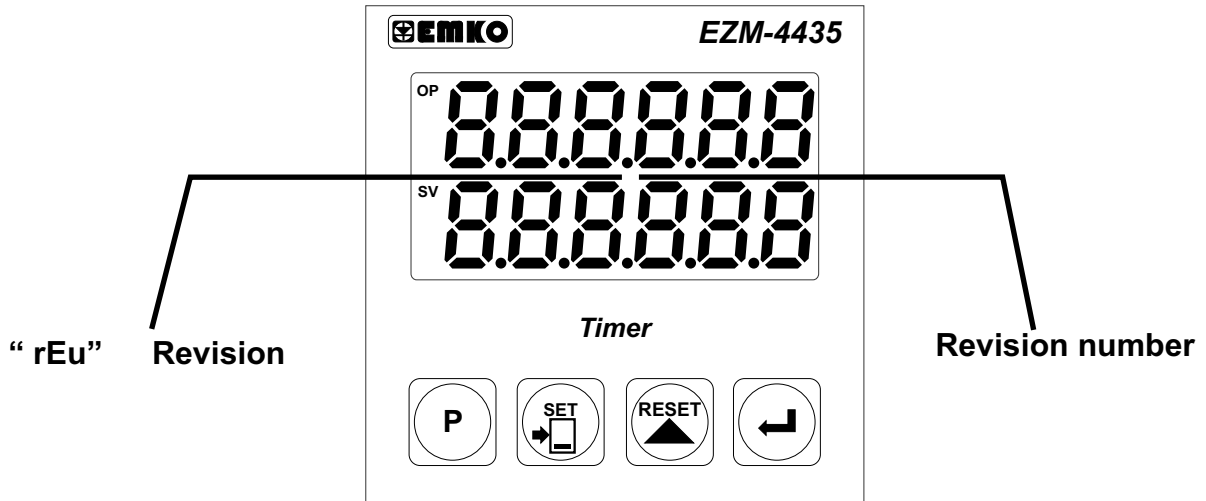

Software Revision



Main screen is shown.



If there is an unexpected situation while opening the device, power off the device and inform a qualified personnel.

4.3 Adjustment of SET Value

Changing SET Value

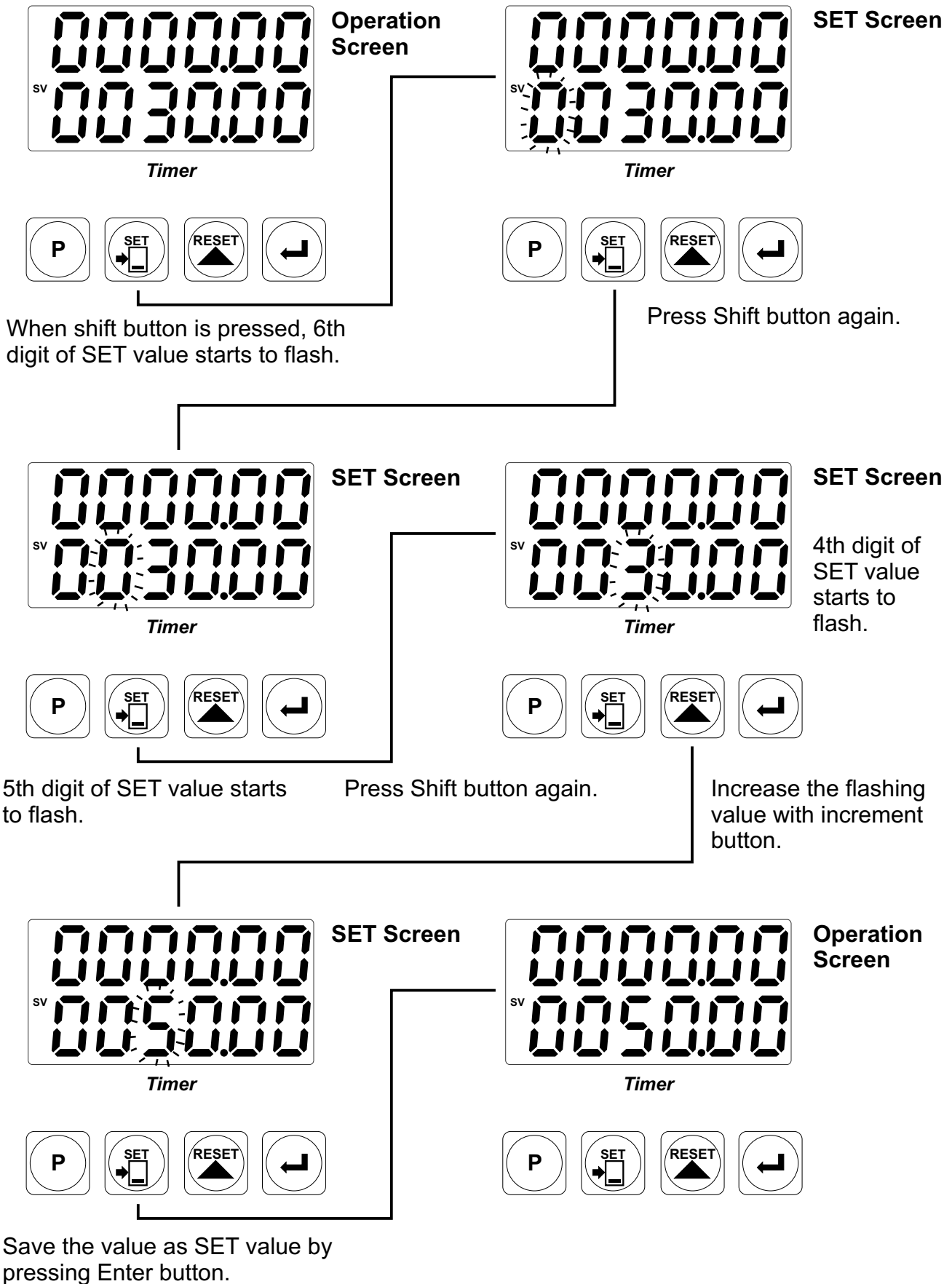

4.4 Resetting the Count Value

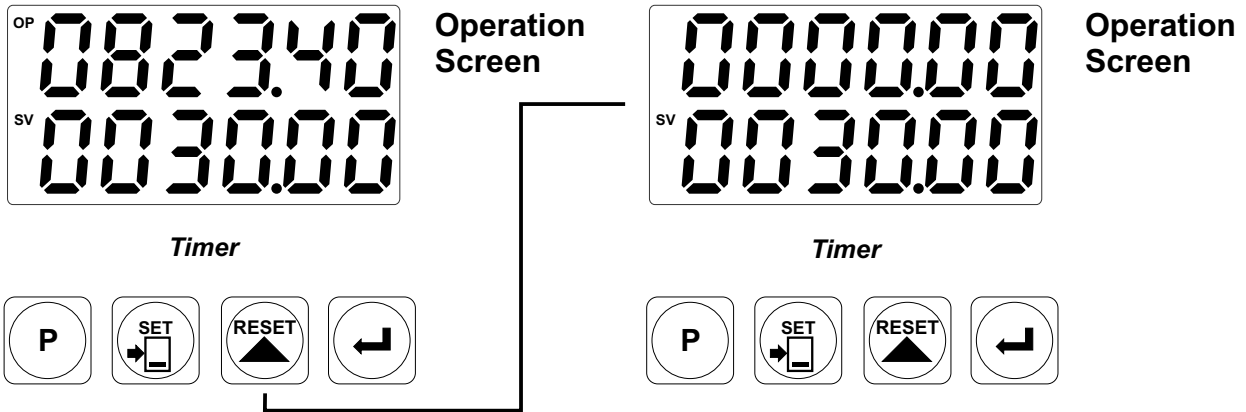

When RESET button is pressed, Actual Value becomes the 0 Value.



RESET operation can be realized by Reset button or applying signal to the RESET input. These two operations are named MANUAL RESET in parameters section.

At the end of MANUAL RESET; if `direct = 000000` then Count value becomes 0 value. If `direct = 000001` then Count value becomes SET value.

4.5 Accessing to the Program Parameters

In this section Accessing to the Program parameters process is shown. For details on parameters refer to PROGRAM PARAMETERS section.

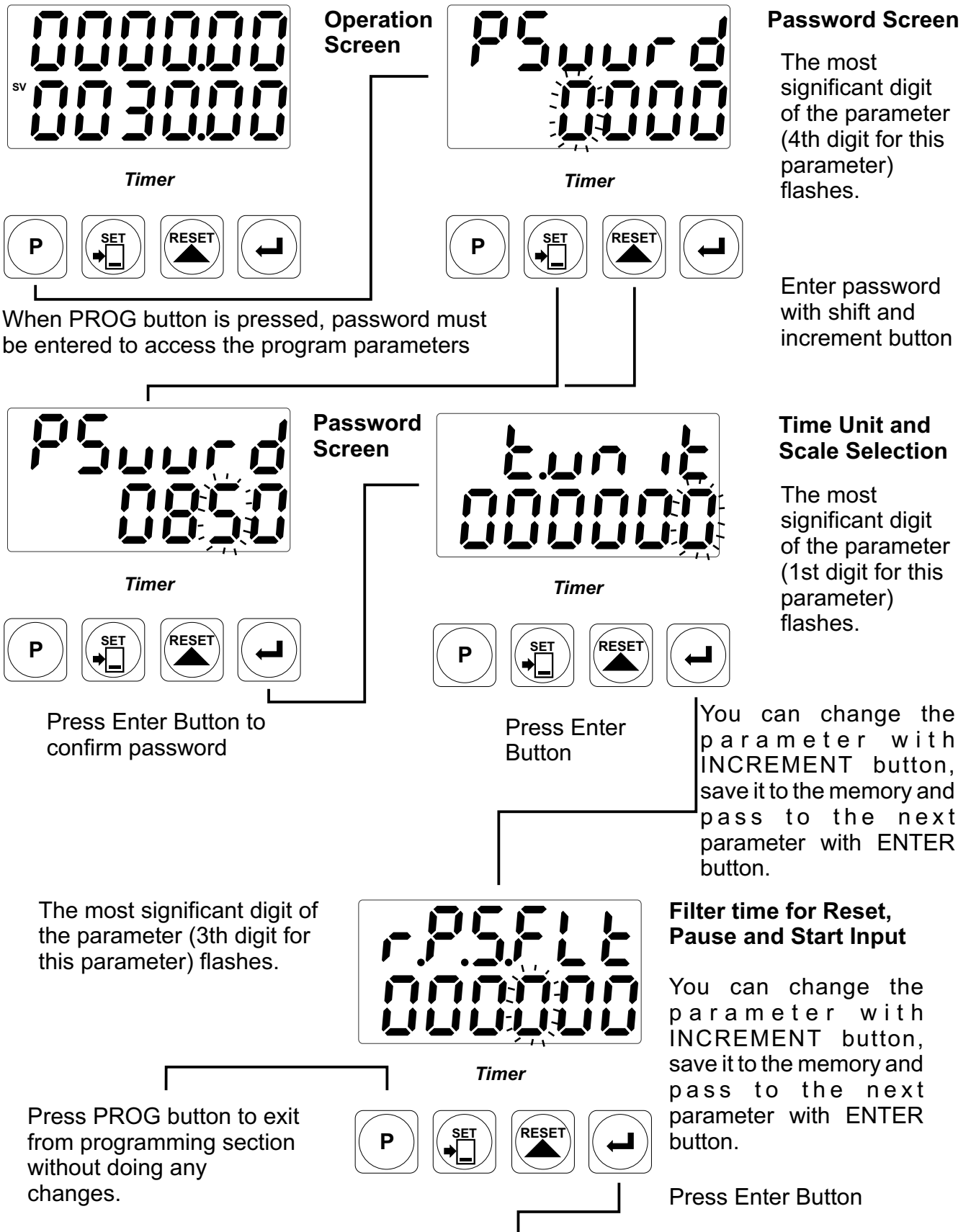

The most significant digit of the parameter (1st digit for this parameter) flashes.

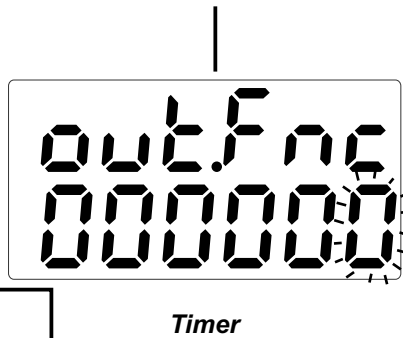

Output Functions

You can change the parameter with INCREMENT button, save it to the memory and pass to the next parameter with ENTER button.

Press PROG button to exit from programming section without doing any changes.

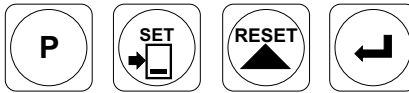

Press Enter Button

The most significant digit of the parameter (1st digit for this parameter) flashes.



Output Run Type

You can change the parameter with INCREMENT button, save it to the memory and pass to the next parameter with ENTER button.

Press PROG button to exit from programming section without doing any changes.

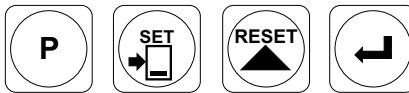

Press Enter Button

The most significant digit of the parameter (6th digit for this parameter) flashes.

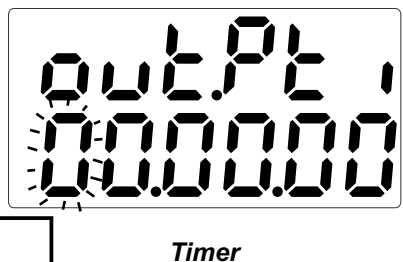

Output Pulse Time

You can change the parameter with INCREMENT button, save it to the memory and pass to the next parameter with ENTER button.

Press PROG button to exit from programming section without doing any changes.

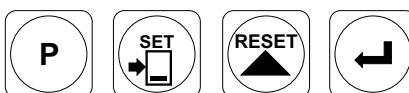

Press Enter Button

The most significant digit of the parameter (1st digit for this parameter) flashes.

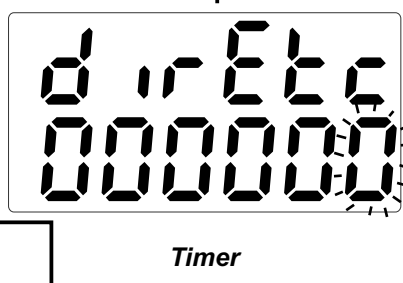

Counting Direction

You can change the parameter with INCREMENT button, save it to the memory and pass to the next parameter with ENTER button.

Press PROG button to exit from programming section without doing any changes.



Press Enter Button

The most significant digit of the parameter (1st digit for this parameter) flashes.

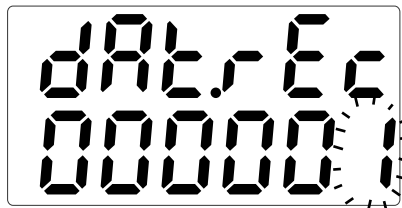

Timer

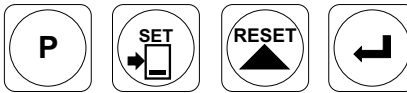

Press PROG button to exit from programming section without doing any changes.

Data Record

You can change the parameter with INCREMENT button, save it to the memory and pass to the next parameter with ENTER button.

The most significant digit of the parameter (1st digit for this parameter) flashes.

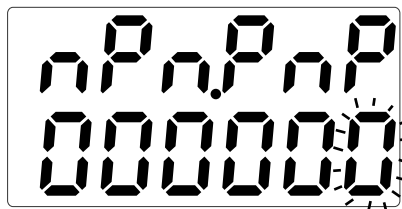

Timer

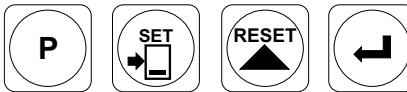

Press PROG button to exit from programming section without doing any changes.

Press Enter Button

Sensor Type Selection

You can change the parameter with INCREMENT button, save it to the memory and pass to the next parameter with ENTER button.

The most significant digit of the parameter (1st digit for this parameter) flashes.

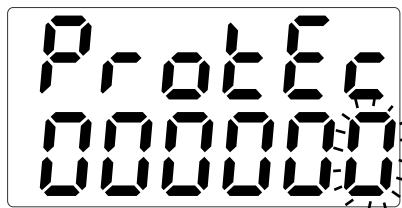

Timer

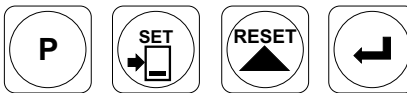

Press PROG button to exit from programming section without doing any changes.

Press Enter Button

Reset and Set Protection

You can change the parameter with INCREMENT button, save it to the memory and pass to the next parameter with ENTER button.

The most significant digit of the parameter (4th digit for this parameter) flashes.

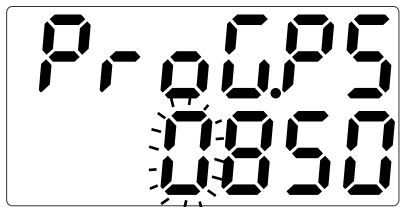

Timer

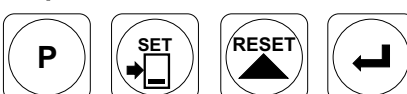

Press PROG button to exit from programming section without doing any changes.

Press Enter Button

Program Password

You can change the parameter with INCREMENT button, save it to the memory and pass to the next parameter with ENTER button.

Press Enter Button

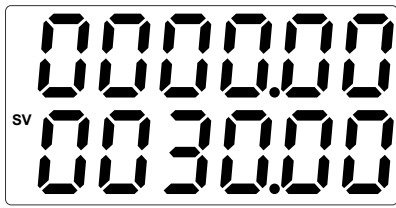

Timer

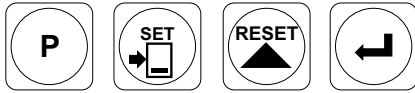

Operation Screen

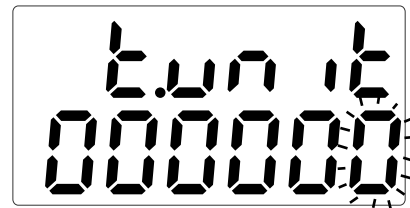

Timer

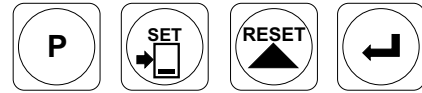

Time Unit and Scale Selection

Continue to press ENTER button for scanning all parameters.

5. Program Parameters

t.un it

Time Unit and Scale Selection

000000

Hour/Minute

It can be adjusted from 000000 to 009959

000001

Minute/Second

It can be adjusted from 000000 to 009959

000002

Second/Millisecond

It can be adjusted from 000000 to 009999

000003

Hour/Minute

It can be adjusted from 000000 to 002359

000004

Hour

It can be adjusted from 000000 to 099999

000005

Minute

It can be adjusted from 000000 to 099999

000006

Second

It can be adjusted from 000000 to 099999

r.p.s.flt

Filter Time of Reset, Pause and Start Inputs

It is used to protect against the electrical contact debounce or the signal that is less than the determined pulse time.

It can be adjusted from 000002 to 000250 msec.

out.Fnc

Output Functions

out.Fnc = 000000

Manual Reset-1.
Device continues to count till manual reset is applied.
(Output PulseTime `outPt1` is not considered)

Count direction : 0 --> P (Upcounting)

`direct` = 000000

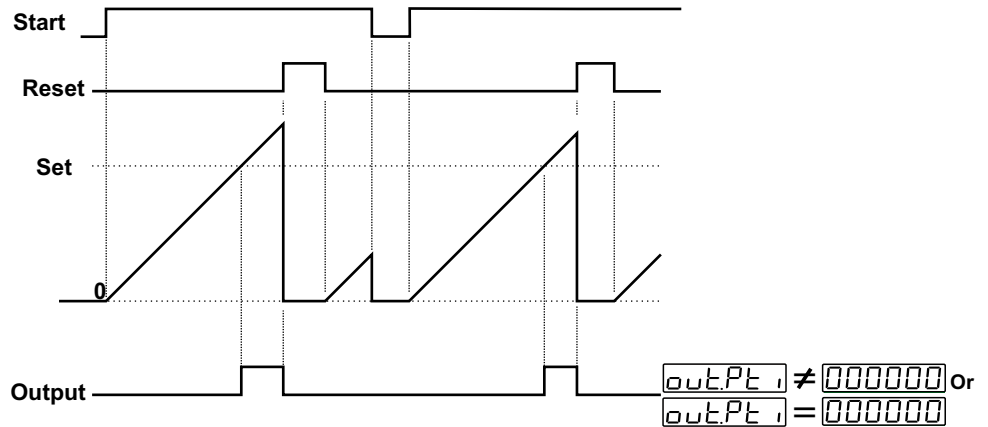

When count value reaches the Set Value, Output Position is changed. Counting process continues over the SET value. Output Pulse Time is not considered. Process counts, until manual reset happens. Counting is continues, while Start input is active. When Start input is passive, count value becomes "0". When Manual Reset happens, count value becomes 0 value.

Counting direction : P --> 0 (Downcounting)

`direct` = 000001

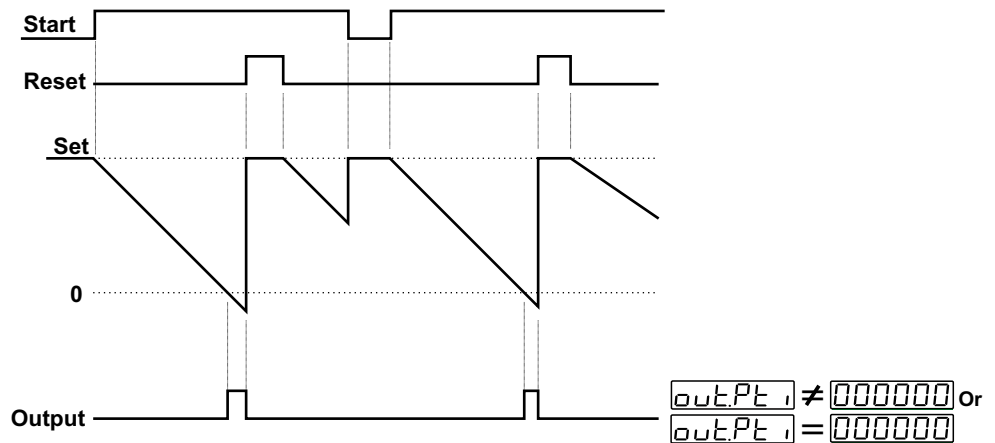

When count value reaches the 0 Value, Output Position is changed. Counting process continues under the 0 value. Output Pulse Time is not considered. Process counts, until manual reset happens. Counting is continues, while Start input is active. When Start input is passive, count value becomes SET value. When Manual Reset happens, count value becomes SET value.

out.Fnc = 000001

Manual Reset-2.

Device continues to count till manual reset is applied.
(Output pulse Time `out.Pt1` is not considered)

Counting direction : 0 --> P (Upcounting)

`direct` = 000000

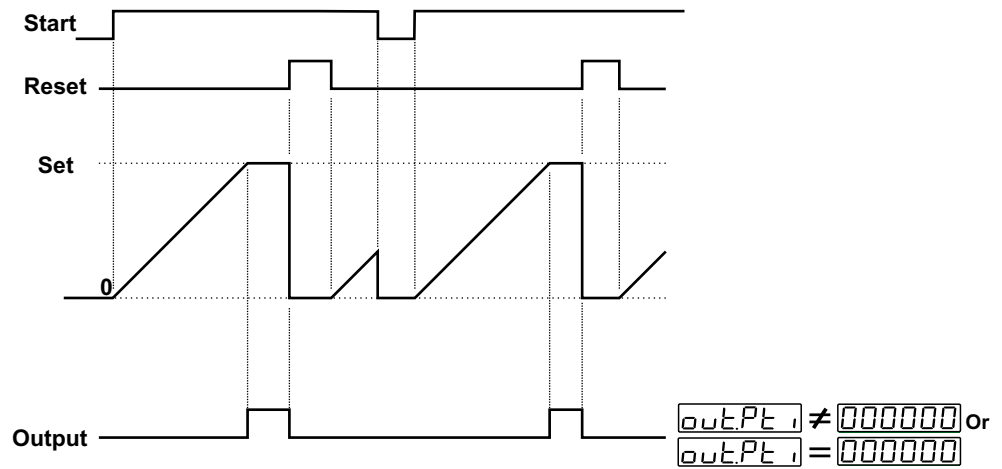

When count value reaches the Set Value, Output Position is changed. Counting process is not continue over the SET value. Output Pulse Time is not considered. Process counts, until manual reset happens. When Manual Reset happens, count value becomes 0 value. Counting is continues, while Start input is active. When Start input is passive, count value becomes "0".

Counting direction : P --> 0 (Downcounting)

`direct` = 000001

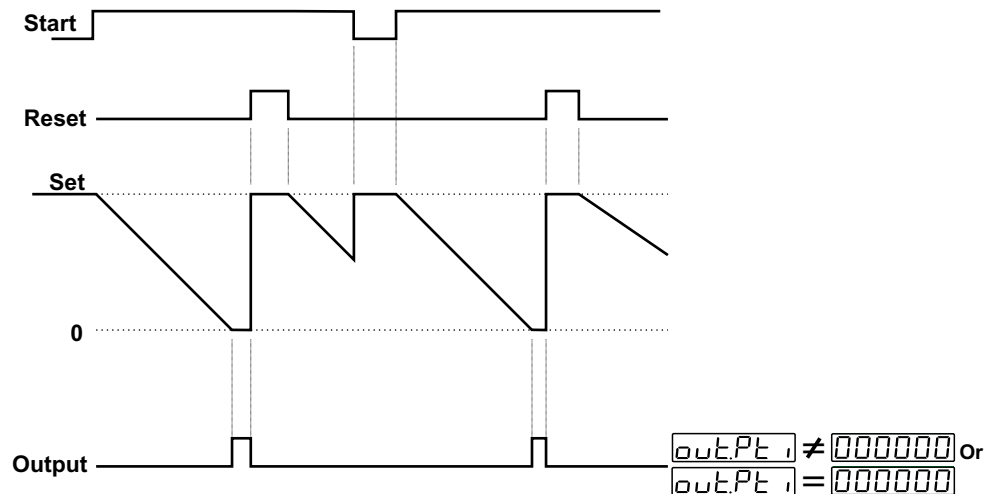

When count value reaches the 0, Output Position is changed. Counting process is not continue under the 0 value. Output Pulse Time is not considered. Process counts, until manual reset happens. When Manual Reset happens, count value becomes SET value. Counting is continues, while Start input is active. When Start input is passive, count value becomes SET value.

out.Fnc = 000002

Manual Reset-3.

Device continues to count till manual reset is applied.
(Output Pulse Time `out.Pt1` is considered.)

Counting direction : 0 --> P (Upcounting) `direct` = 000000

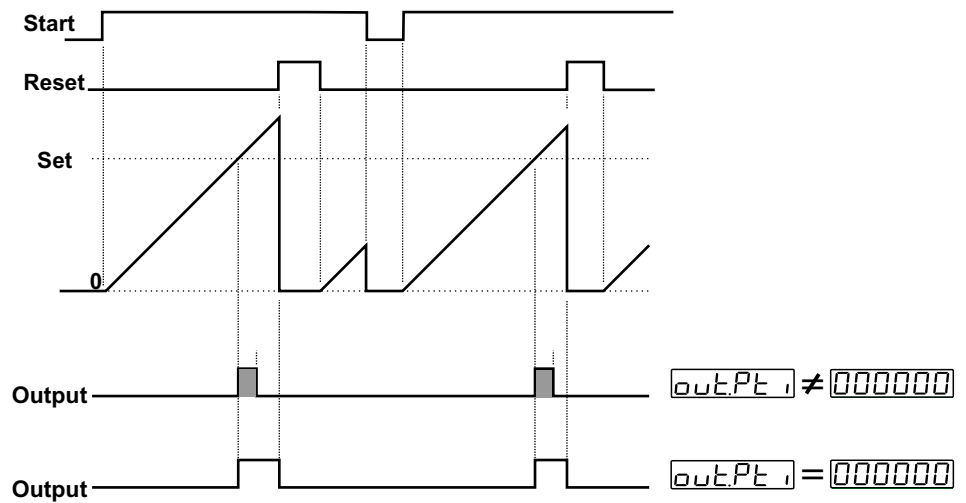

When count value reaches the Set Value, Output Position is changed. If Output Pulse time `out.Pt1` is not 0, then Output Position is changed at the end of the Pulse time. If `out.Pt1` = 000000 then Output Position has not change, until Manual Reset happens. Counting process continues over the SET value. When Manual Reset happens, count value becomes 0 value. When Start input is passive, count value becomes "0".

Counting direction : P --> 0 (Downcounting) `direct` = 000001

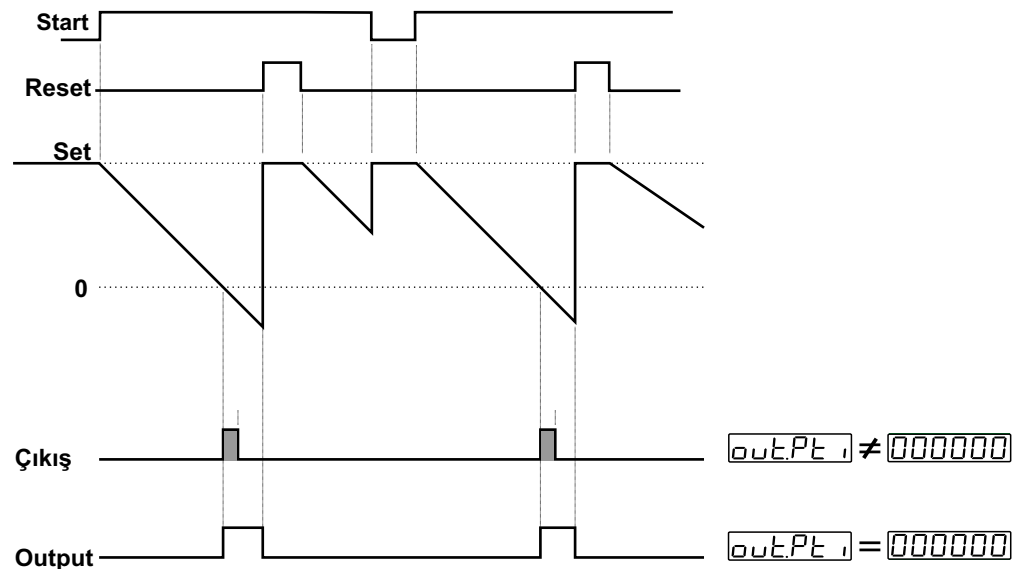

When count value reaches the 0 Value, Output Position is changed. If Output Pulse time `out.Pt1` is not 0, then Output Position is changed at the end of the Pulse time. If `out.Pt1` = 000000 then Output Position has not change until Manual Reset happens. Counting process continues under the 0 value.

When Manual Reset happens count value becomes SET value. When Start input is passive, count value becomes SET value.

out.Fnc = 000003

Automatic Reset-1

Counting direction : 0 --> P (Upcounting) direct = 000000

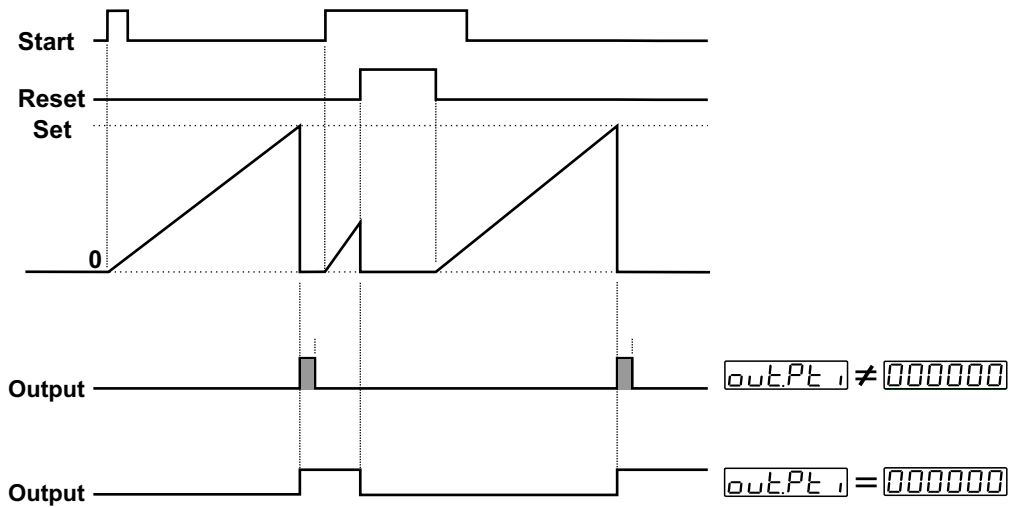

When count value reaches the Set Value, Output Position is changed. Actual value is reset automatically. While Start input is active, then counting starts upcounting from 0 value. If Output Pulse time is not 0, then Output Position is changed at the end of the Pulse time.

If Output Pulse time is "0", then Output Position has not changed until Manual Reset happens.

When Manual Reset happens, count value becomes 0 value.

Counting direction : P --> 0 (Downcounting) direct = 000001

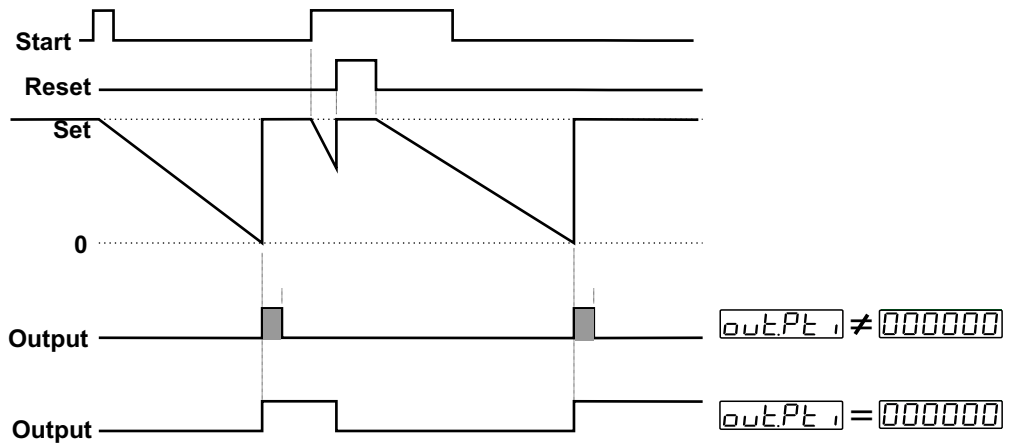

When count value reaches the 0 Value, Output Position is changed. Actual value is reset automatically. If Start input is active, then counting starts downcounting at Set value. If Output Pulse time is not 0, then Output Position is changed at the end of the Pulse time. If Pulse time is "0", then Output Position has not changed until Manual Reset happens.

When Manual Reset happens count value becomes SET value.



If output functions parameter out.Fnc is selected Automatic Reset (000003, 000004, 000005 or 000006), then out.Pt.1 must be different from zero for realizing Automatic Reset.

out.Fnc = 000004

Automatic Reset-2

Counting direction : 0 --> P (Upcounting) direct = 000000

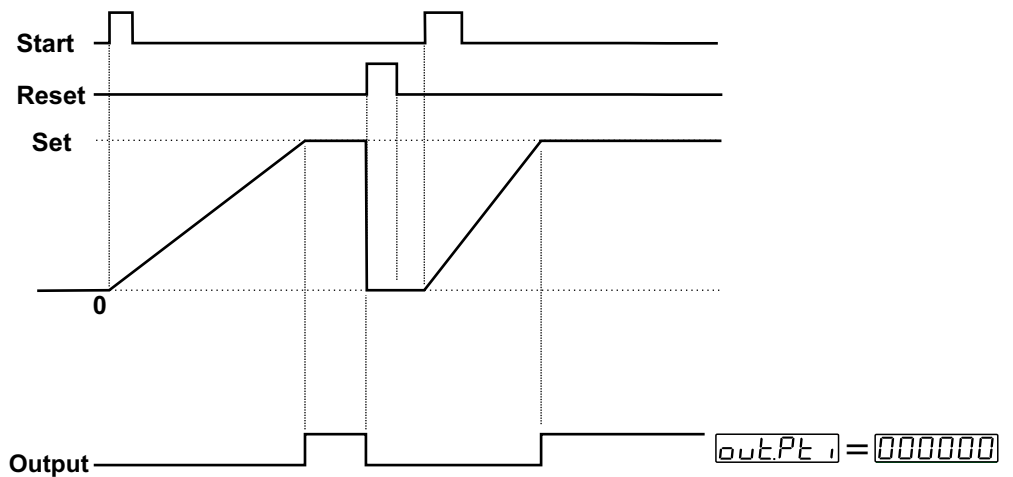
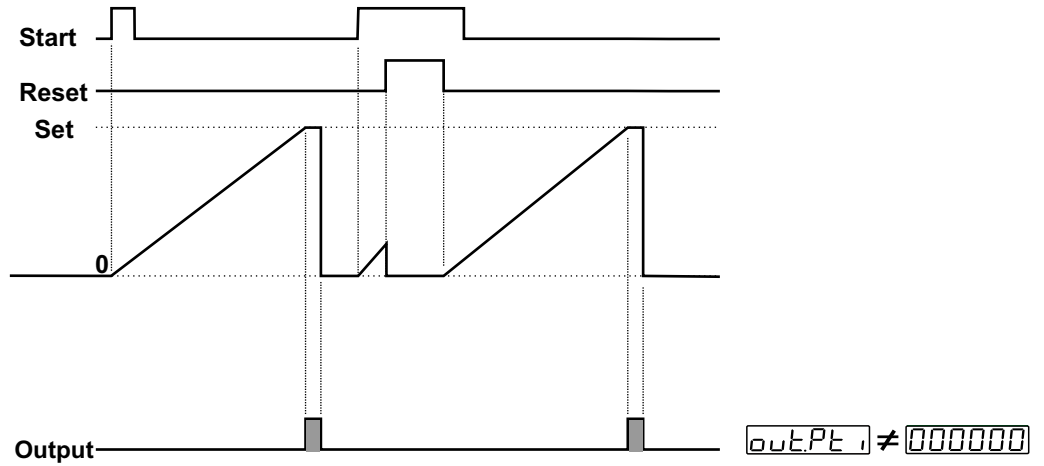

When count value reaches the Set Value, Output Position is changed. If Output Pulse time `out.Pt1` is not 0, then Output Position is changed at the end of the Pulse time and Actual value is reset and if the Start input is active, then counting starts from 0 value. If output pulse time `out.Pt1` is "0", then output position has not change until Manual Reset happens.

Actual counting value stops at SET value. Counting process is not continue over the SET value.

When Manual Reset happens, count value becomes 0 value.



If output functions parameter `out.Fnc` is selected Automatic Reset (`000003`, `000004`, `000005` or `000006`), then `out.Pt1` must be different from zero for realizing Automatic Reset.

Counting direction : P --> 0 (Downcounting) $d_{irEct} = 000001$

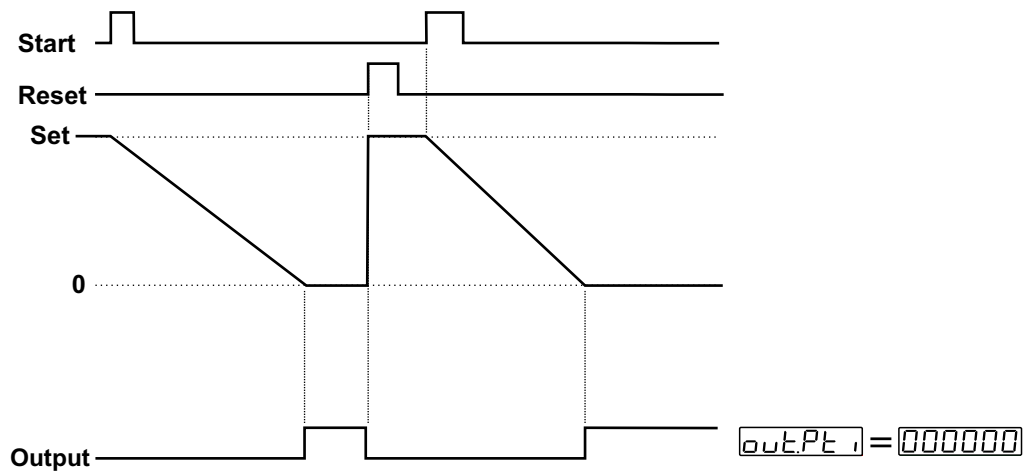
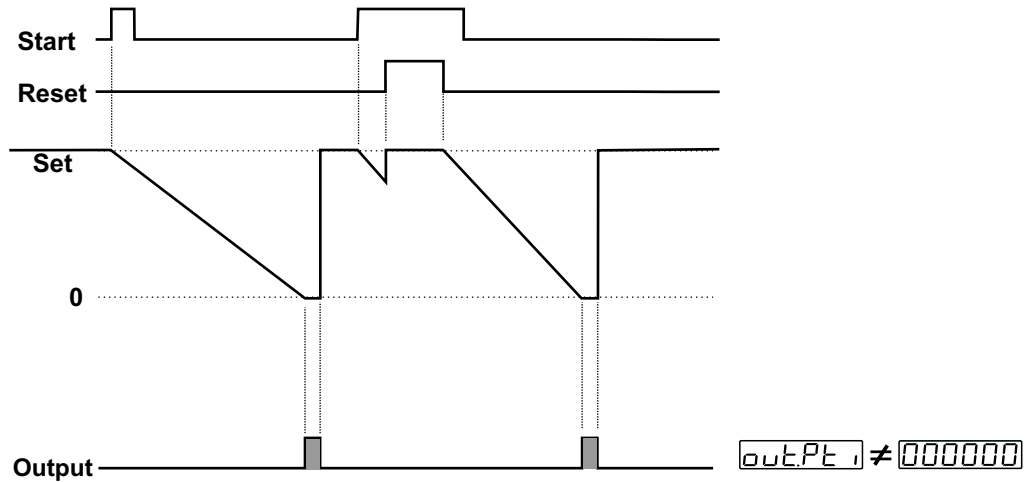

When count value reaches the 0 Value, Output Position is changed. If Output Pulse time $OUT.PT.1$ is not 0, then Output Position is changed at the end of the Pulse time and Actual value is reset. If the Start input is active, then counting starts from Set value. If output pulse time $OUT.PT.1$ is 0, then output position has not change until Manual Reset happens. Actual counting value stops at 0 value. Counting process is not continue under the 0 value.
When Manual Reset happens count value becomes SET value.



If output functions parameter $OUT.Fnc$ is selected Automatic Reset (000003 , 000004 , 000005 or 000006), then $OUT.PT.1$ must be different from zero for realizing Automatic Reset.

out.Fnc = 000005

Automatic Reset-3

Counting direction : 0 --> P (Upcounting) direct = 000000

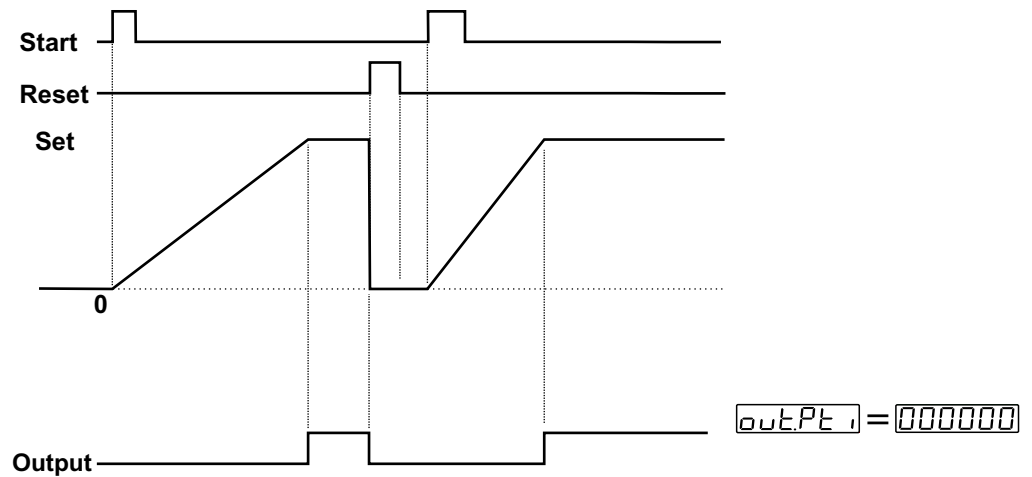
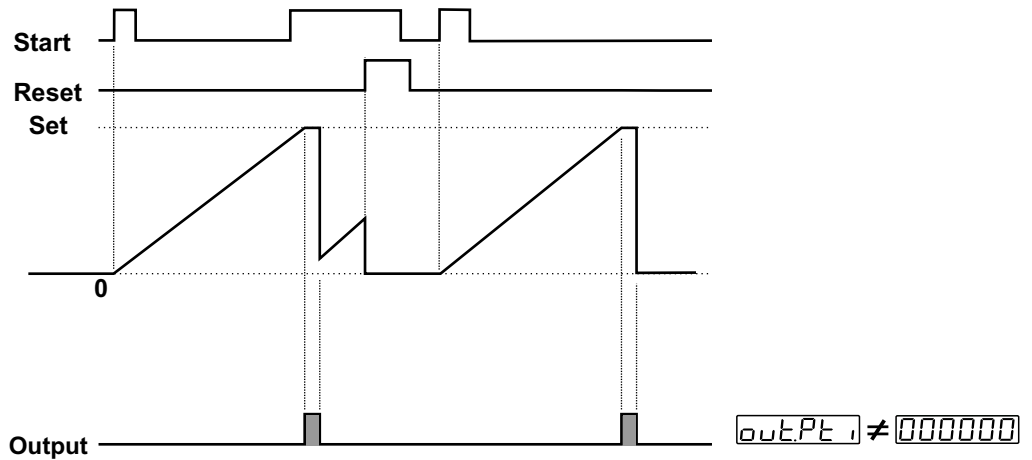

When count value reaches the Set Value, Output Position is changed. If Output Pulse time `out.PE1` is not 0, then Output Position is changed at the end of the Pulse time and Real counting value is shown on Actual value screen. If output pulse time `out.PE1` = 000000 then, output position has not change until Manual Reset happens.

When counting value reach SET value, output position becomes active position and if the Start input is active, then count value starts counting from 0 value. But SET value is observed in actual value display. Counting process has not continue over SET value.

When Manual Reset happens, count value becomes 0 value.



If output functions parameter `out.Fnc` is selected Automatic Reset (000003, 000004, 000005 or 000006), then `out.PE1` must be different from zero for realizing Automatic Reset.

Counting direction : P --> 0 (Downcounting) $dirEct = 000001$

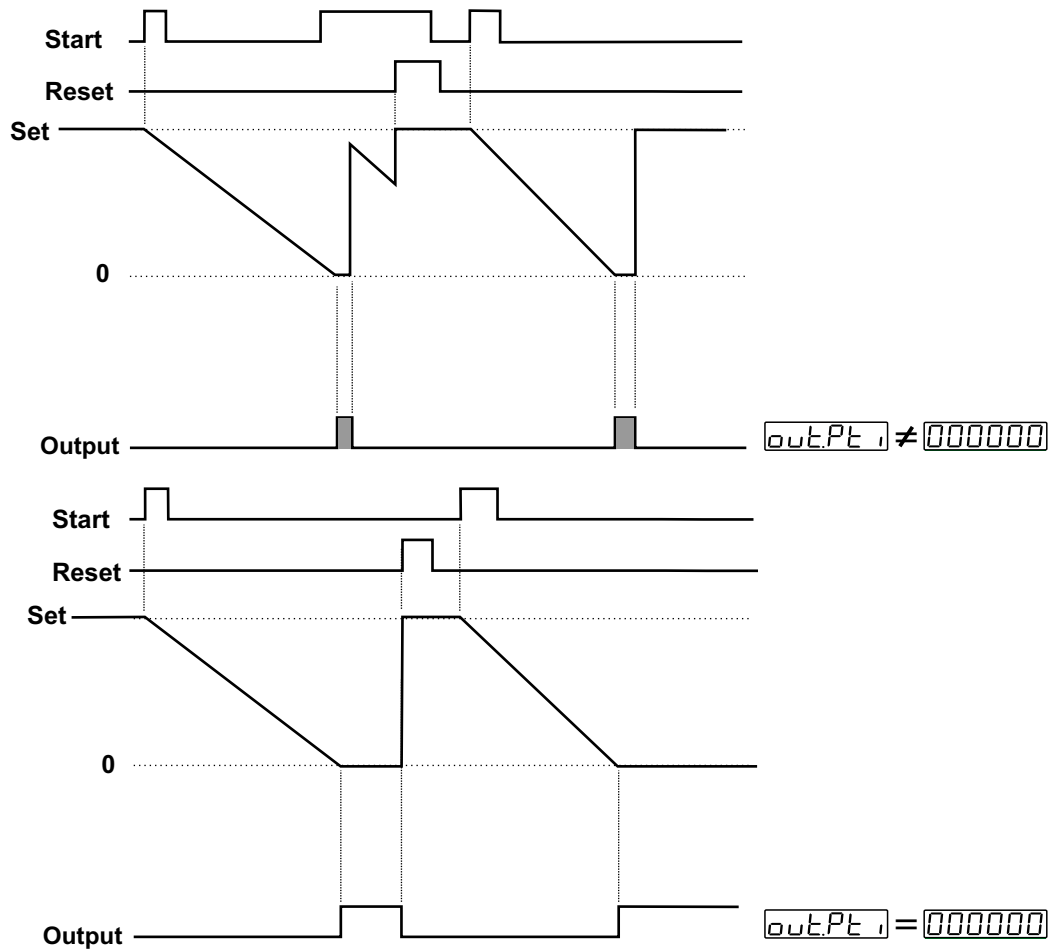

When count value reaches the 0 Value, Output Position is changed. If Output Pulse time $out.PT_1$ is not 0, then Output Position is changed at the end of the Pulse time and Real counting value is shown on Actual value screen. If output pulse time $out.PT_1 = 000000$, then output position has not change until Manual Reset happens.

When counting value reach 0 value, output position becomes active position and if the Start input is active, then count value starts counting from Set value. But 0 value is observed in actual value display. Counting process has not continue under 0 value.

When Manual Reset happens count value becomes SET value.



If output functions parameter $out.Fnc$ is selected Automatic Reset (000003 , 000004 , 000005 or 000006), then $out.PT_1$ must be different from zero for realizing Automatic Reset.

out.Fnc = 000006

Automatic Reset-4

Counting direction : 0 --> P (Upcounting) direct = 000000

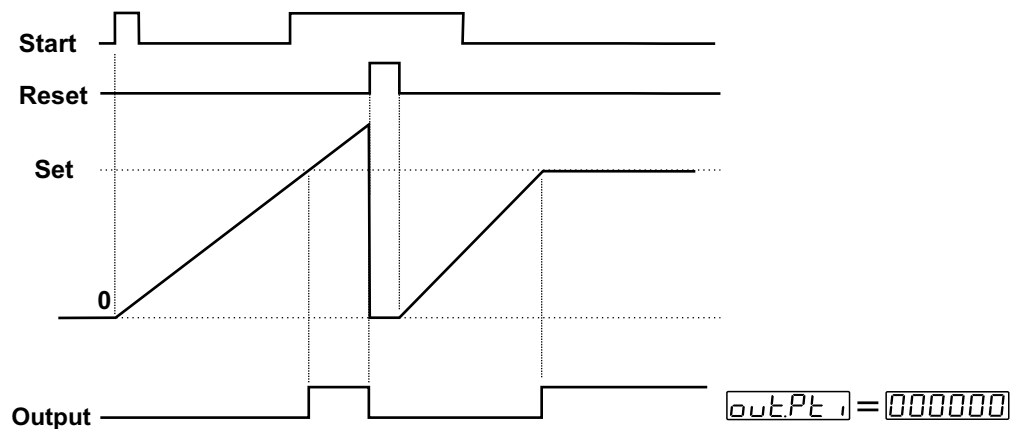
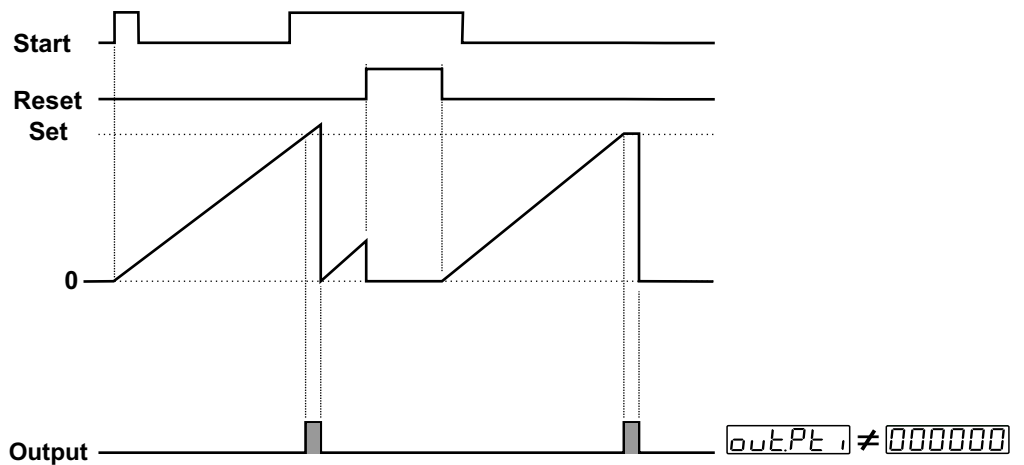

When count value reaches the Set Value, Output Position is changed. If Output Pulse time $out.Pt_1$ is not 0, then Output Position is changed at the end of the Pulse time and counting value becomes 0 and output becomes inactive position. If output pulse time $out.Pt_1 = 000000$, then output position has not change until Manual Reset happens. When counting value reach Set value, output position becomes active position. If the Start input is active, then counting continue over the Set value. When Manual Reset happens, count value becomes 0 value.



If output functions parameter $out.Fnc$ is selected Automatic Reset (000003, 000004, 000005 or 000006), then $out.Pt_1$ must be different from zero for realizing Automatic Reset.

Counting direction : P --> 0 (Downcounting) $direct = 000001$

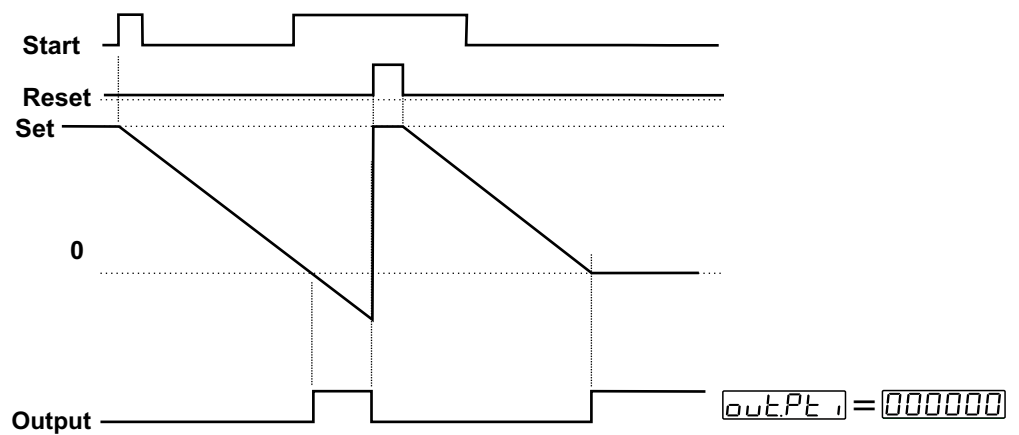
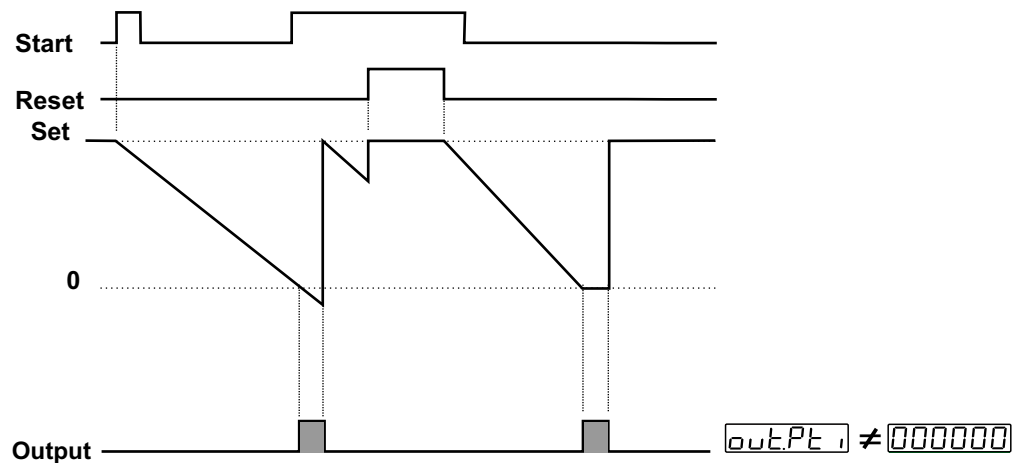

When count value reaches the 0 Value, Output Position is changed. If Output Pulse time $outPt1$ is not 0, then Output Position is changed at the end of the Pulse time and counting value becomes Set value and output becomes inactive position. If output pulse time $outPt1 = 000000$, then output position has not change until Manual Reset happens. When counting value reach 0 value, output position becomes active position. If the Start input is active, then counting continue under the 0 value. When Manual Reset happens count value becomes SET value.



If output functions parameter $outFnc$ is selected Automatic Reset (000003 , 000004 , 000005 or 000006), then $outPt1$ must be different from zero for realizing Automatic Reset.

out.Fnc = 000007

Automatic Reset-5

out.Pt 1 is not considered.

Counting direction : 0 --> P (Upcounting)

direct = 000000

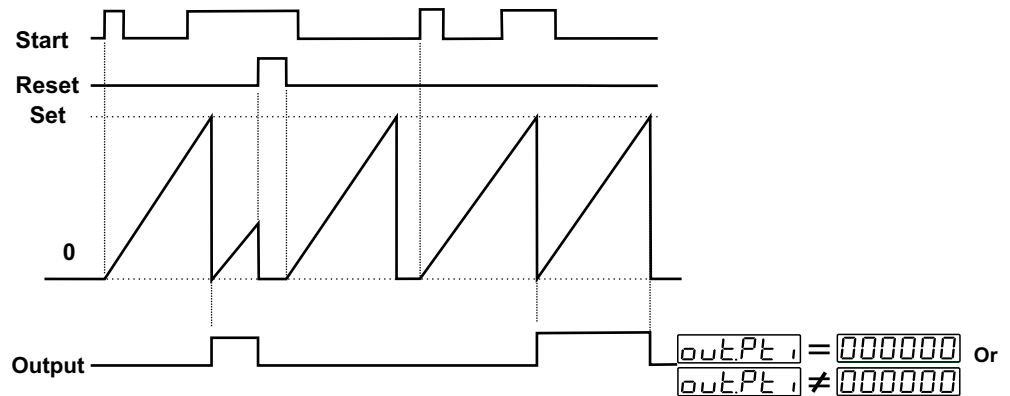

If the Start input is active, then Process starts counting, until count value reach SET value. When count value reach SET value, Output Position becomes active position and process is automatically reset. If the Start input is active, then process start counting from "0" value. If count value reach SET value, Output Position becomes passive position. When manual reset happens, count value becomes "0".

Counting direction : P --> 0 (Downcounting)

direct = 000001

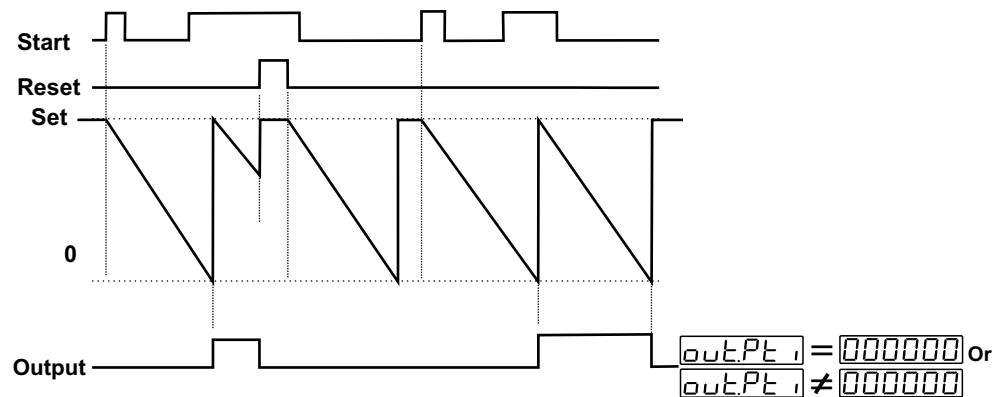

If the Start input is active, then Process starts counting, until count value reach "0" value. When count value reach "0" value, Output Position becomes active position and process is automatically reset. If the Start input is active, then process start counting from SET value. If count value reach "0" value, Output Position becomes passive position. When manual reset happens, count value becomes SET value.

out.run

Output Run Type

000000

Output Normally non-energised

000001

Output Normally energised

out.Pt

Output Pulse Time

It determines how long Output will be active.

It can be adjusted from 00.00.00 to 99.59.99 (99 minutes; 59.99 seconds).

For details, refer to the section where output functions `out.Fnc` are defined

direct

Direction of Counting

000000

Upcount. (0 --> Preset)

000001

Downcount. (Preset --> 0)

data.rec

Data Record

000000

Count value is saved to memory when power is disconnected and restored on power up.

000001

Count value is not saved to memory when power is disconnected. When power up `000000` is shown on the screen.

nPNPNP

Sensor Type Selection

000000

NPN type sensor selected

000001

PNP type sensor selected

Protect

Reset and Set Protection (for Front Panel Access)

000000

There is no Reset and Set protection

000001

Only RESET Button protection is active.
Actual value can not be reset by Reset button.

000002

SET value can not be changed.

000003

Full protection ; Reset protection is active and SET value can not be changed.

Prog.PS

Program Password

It is used for accessing to the program parameters. It can be adjusted from 000000 to 009999.

If it is 000000, there is no password protection while accessing to the parameters.

When programming button is pressed, Prog will appear on the display.

If program password is not "0" while accessing to the program parameters;

1- If user does not enter the Pswurd value correctly; operation screen will appear without entering to operator parameters.

2- When Pswurd in top display and 000000 in bottom display, if user presses ENTER button without entering password (for observing the parameters):

User can see all parameters except Program Password but device does not allow to do any changes with parameters.

6. Failure Messages in EZM-4435 Programmable Timer

1-If the password is not 0, user can access to the parameters without entering the password and by pressing ENTER button.

User can see all parameters except for programming password parameter `PROG` but user can not do any changes in parameters. If password is entered for accessing to the parameters correctly, most significant digit of the parameter flashes. But if the password is not entered, flashing of the most significant digit is not realised.

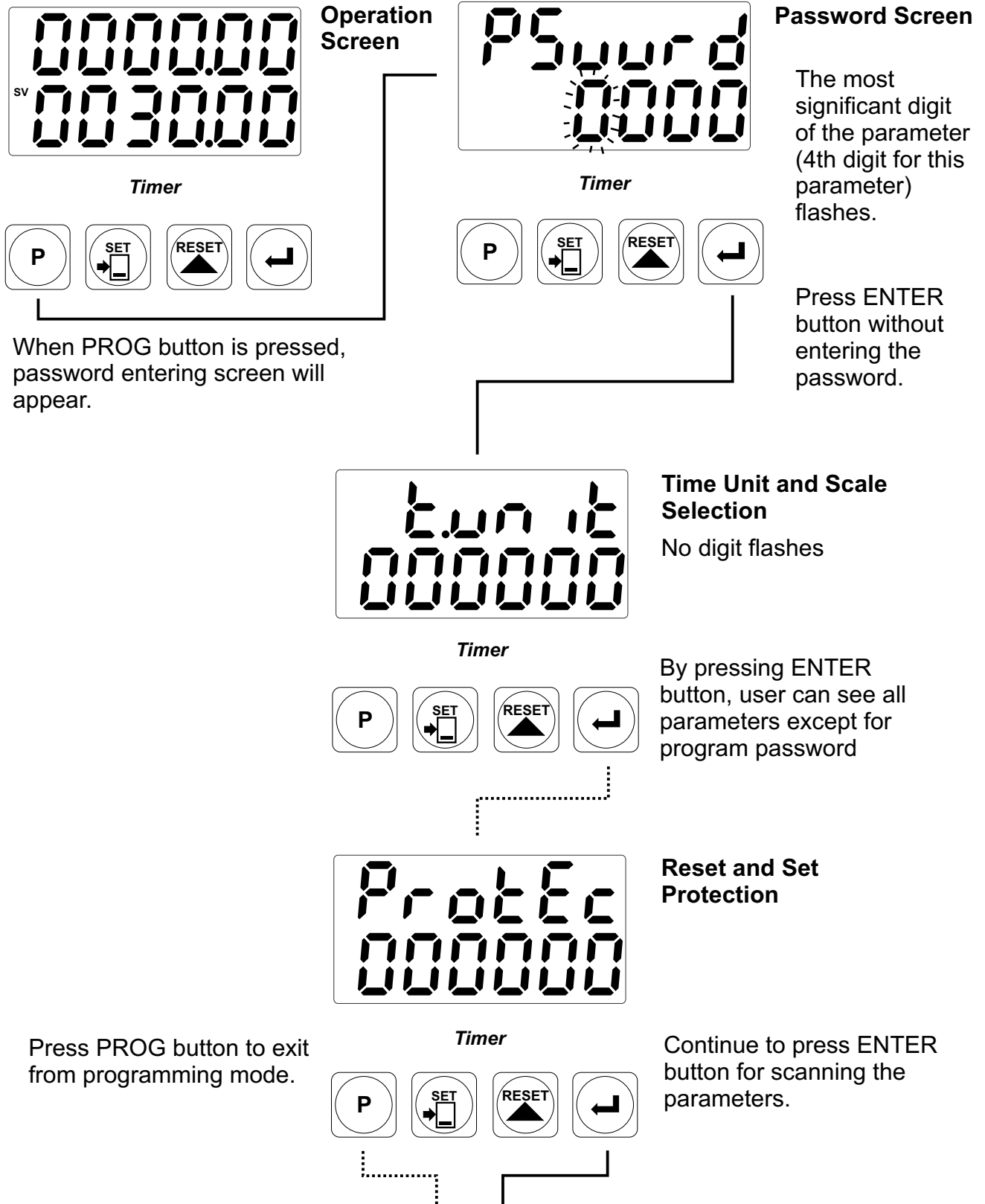

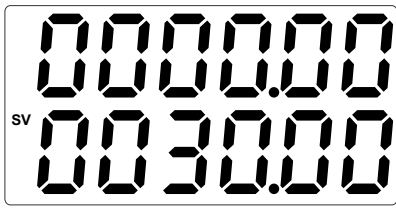

Timer

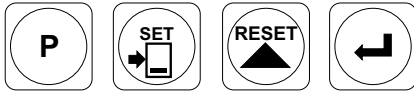

Operation Screen

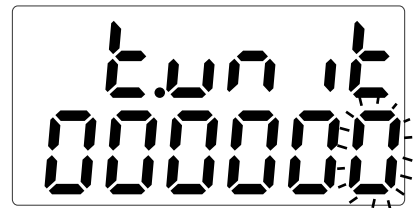

Timer

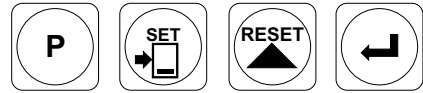

Time Unit and Scale Selection

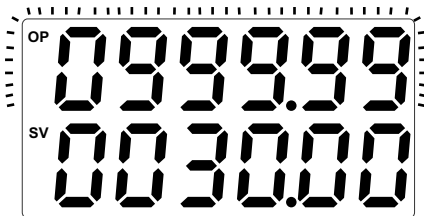

Timer

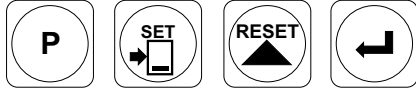

2-If Actual Value is flashing and counting is stopped ;
It appears if any of the count value is greater than the maximum count value.
To remove this warning and reset the count value press RESET button.

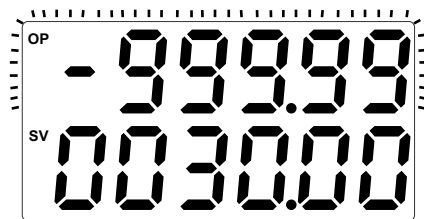

Timer

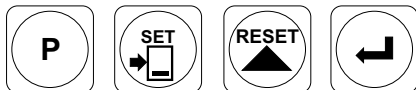

3-If Actual Value is flashing and counting is stopped ;
It appears if any of the count value is lower than the minimum count value.
To remove this warning and reset the count value press RESET button.

7. Specifications

Device Type	: Programmable Timer
Housing & Mounting	: 48mm x 48mm x 87.5 DIN Size 43700 plastic housing for panel mounting. Panel cut-out is 46x46mm
Protection Class	: NEMA 4X (IP65 at front, IP20 at rear).
Weight	: Approximately 0.21 Kg.
Environmental Ratings	: Standard, indoor at an altitude of less than 2000 meters with none condensing humidity
Storage / Operating Temperature:	-40 °C to +85 °C / 0 °C to +50 °C
Storage / Operating Humidity	: 90 % max. (None condensing)
Installation	: Fixed installation
Over Voltage Category	: II
Pollution Degree	: II, office or workplace, none conductive pollution
Operating Conditions	: Continuous
Supply Voltage and Power	: 230 V ~ (-%15 / +%10) 50/60 Hz. 2.3VA 115 V ~ (-%15 / +%10) 50/60 Hz. 2.3VA 24 V ~ (-%15 / +%10) 50/60 Hz. 2.3VA
Digital Inputs	
Electrical Characteristics	: Rated voltage : 16 V _{DC} @ 5mA Maximum continuous permissible voltage : 30 V _{DC} Logic 1 minimum level : 3 V _{DC} Logic 0 maximum level : 2 V _{DC}
Sensor Supply Voltage	
Electrical Characteristics	: 12V _{DC} ± %40 maximum 50mA
Output Type	: Relay Output on Resistive Load 5A@250V~ 100.000 operation (Full Load)
Actual Value Display	: 8 mm Red 6 digit LED Display
Set Display	: 8 mm Green 6 digit LED Display
LED Displays	: SV (Set value) , OP (Control output) LEDs
Approvals	: ENEC, CE

8. Other Informations

Manufacturer Information:

Emko Elektronik Sanayi ve Ticaret A.Ş.
Demirtaş Organize Sanayi Bölgesi Karanfil Sk. No:6 16369
BURSA/TURKEY
Phone : +90 224 261 1900
Fax : +90 224 261 1912

Repair and Maintenance Service Information:

Emko Elektronik Sanayi ve Ticaret A.Ş.
Demirtaş Organize Sanayi Bölgesi Karanfil Sk. No:6 16369
BURSA/TURKEY
Phone : +90 224 261 1900
Fax : +90 224 261 1912



Thank you very much for your preference to use Emko Elektronik Products.

www.emkoelektronik.com.tr