

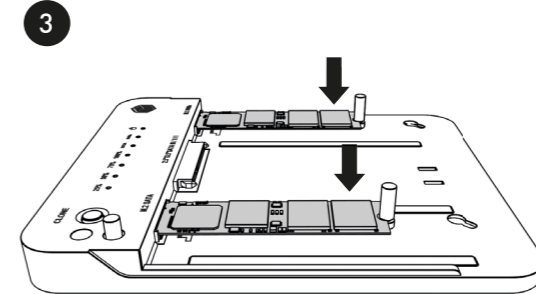

# IB-2915MSCL-C31

CloneStation & DockingStation  
for M.2 NVMe & SATA 2.5"/3.5" SSD/HDD

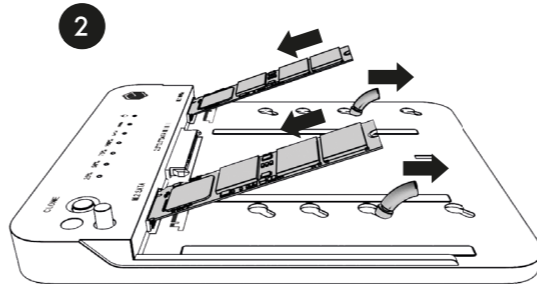
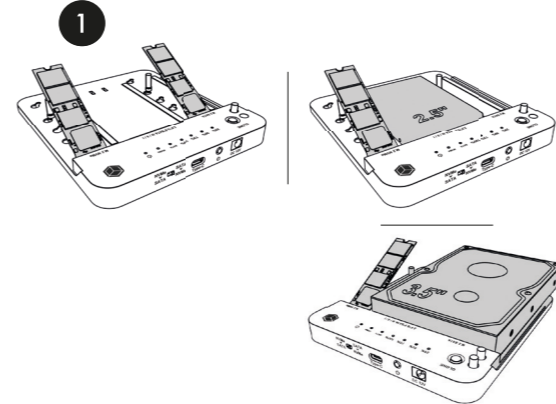
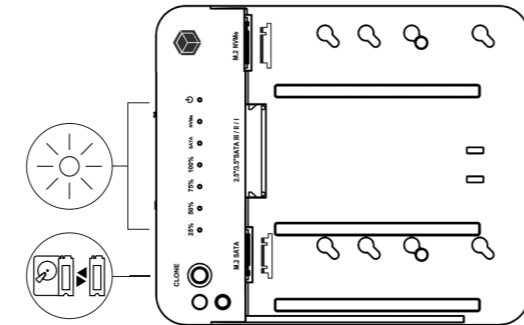
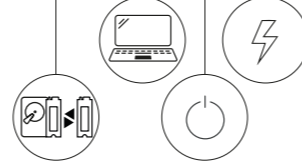
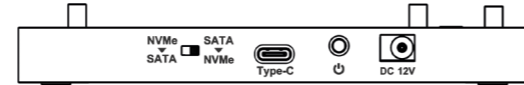
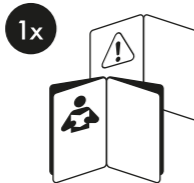
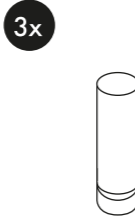
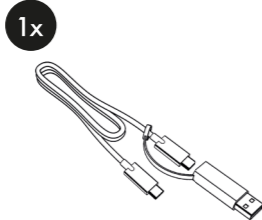
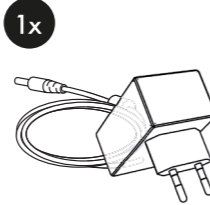
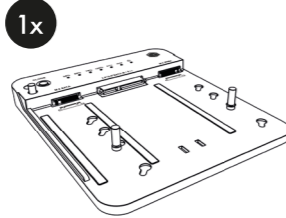
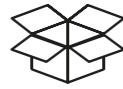
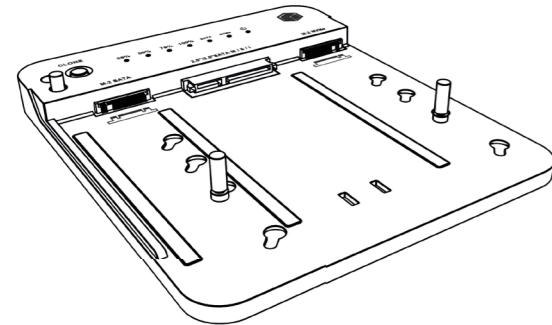

Legacy USB standards	Current USB standards	Data transfer rate
USB 3.0 = USB 3.1 (Gen 1)	= USB 3.2 Gen 1	= 5 Gbit/s
USB 3.1 = USB 3.1 (Gen 2)	= USB 3.2 Gen 2	= 10 Gbit/s
USB 3.2 (Gen 2x2)	= USB 3.2 Gen 2x2	= 20 Gbit/s



© Copyright 2023 by RaidSonic Technology GmbH. All Rights Reserved.  
The information contained in this manual is believed to be accurate and reliable. RaidSonic Technology GmbH assumes no responsibility for any errors contained in this manual. RaidSonic Technology GmbH reserves the right to make changes in the specifications and/or design of the above-mentioned product without prior notice. The diagrams contained in this manual may also not fully represent the product that you are using and are there for illustration purposes only. RaidSonic Technology GmbH assumes no responsibility for any differences between the product mentioned in this manual and the product you may have.



1

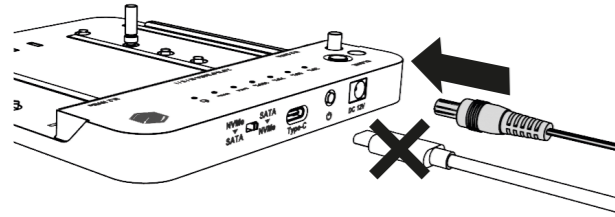

2

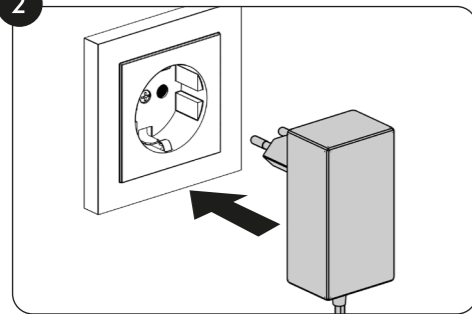

3

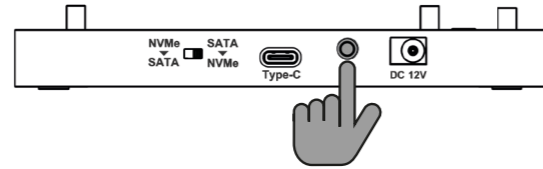

4

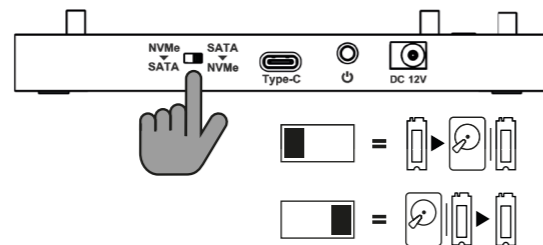

5

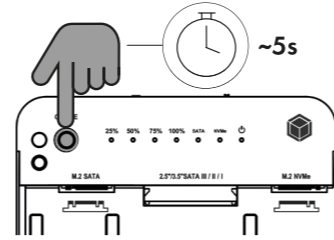

6

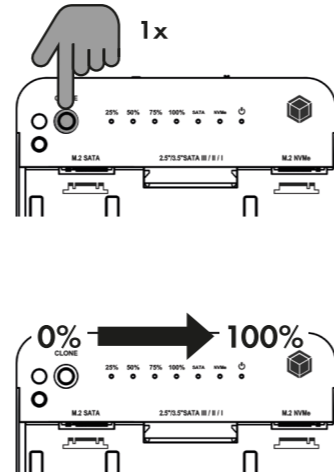

1

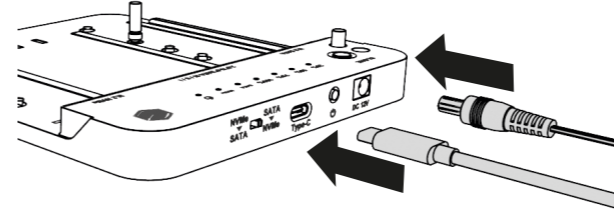

2

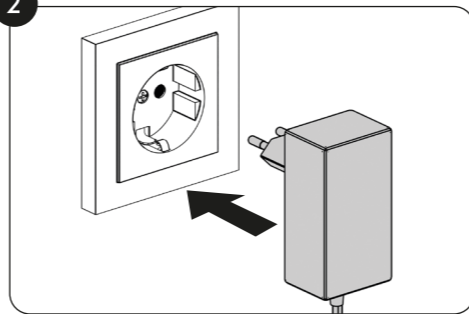

3

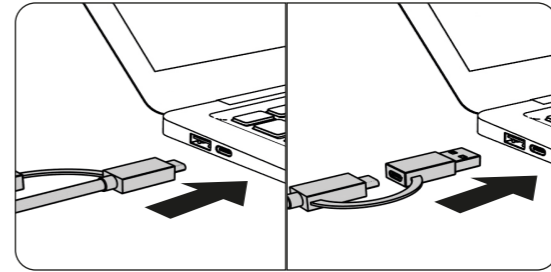

4

