

Model 2470 High Voltage SourceMeter® Instrument

User's Manual

2470-900-01 Rev. A / May 2019



2470-900-01A

Model 2470
High Voltage SourceMeter Instrument
User's Manual

© 2019, Keithley Instruments, LLC

Cleveland, Ohio, U.S.A.

All rights reserved.

Any unauthorized reproduction, photocopy, or use of the information herein, in whole or in part, without the prior written approval of Keithley Instruments, LLC, is strictly prohibited.

These are the original instructions in English.

TSP®, TSP-Link®, and TSP-Net® are trademarks of Keithley Instruments, LLC. All Keithley Instruments product names are trademarks or registered trademarks of Keithley Instruments, LLC. Other brand names are trademarks or registered trademarks of their respective holders.

Microsoft, Visual C++, Excel, and Windows are either registered trademarks or trademarks of Microsoft Corporation in the United States and/or other countries.

Document number: 2470-900-01 Rev. A / May 2019

Safety precautions

The following safety precautions should be observed before using this product and any associated instrumentation. Although some instruments and accessories would normally be used with nonhazardous voltages, there are situations where hazardous conditions may be present.

This product is intended for use by personnel who recognize shock hazards and are familiar with the safety precautions required to avoid possible injury. Read and follow all installation, operation, and maintenance information carefully before using the product. Refer to the user documentation for complete product specifications.

If the product is used in a manner not specified, the protection provided by the product warranty may be impaired.

The types of product users are:

Responsible body is the individual or group responsible for the use and maintenance of equipment, for ensuring that the equipment is operated within its specifications and operating limits, and for ensuring that operators are adequately trained.

Operators use the product for its intended function. They must be trained in electrical safety procedures and proper use of the instrument. They must be protected from electric shock and contact with hazardous live circuits.

Maintenance personnel perform routine procedures on the product to keep it operating properly, for example, setting the line voltage or replacing consumable materials. Maintenance procedures are described in the user documentation. The procedures explicitly state if the operator may perform them. Otherwise, they should be performed only by service personnel.

Service personnel are trained to work on live circuits, perform safe installations, and repair products. Only properly trained service personnel may perform installation and service procedures.

Keithley products are designed for use with electrical signals that are measurement, control, and data I/O connections, with low transient overvoltages, and must not be directly connected to mains voltage or to voltage sources with high transient overvoltages. Measurement Category II (as referenced in IEC 60664) connections require protection for high transient overvoltages often associated with local AC mains connections. Certain Keithley measuring instruments may be connected to mains. These instruments will be marked as category II or higher.

Unless explicitly allowed in the specifications, operating manual, and instrument labels, do not connect any instrument to mains.

Exercise extreme caution when a shock hazard is present. Lethal voltage may be present on cable connector jacks or test fixtures. The American National Standards Institute (ANSI) states that a shock hazard exists when voltage levels greater than 30 V RMS, 42.4 V peak, or 60 VDC are present. A good safety practice is to expect that hazardous voltage is present in any unknown circuit before measuring.

Operators of this product must be protected from electric shock at all times. The responsible body must ensure that operators are prevented access and/or insulated from every connection point. In some cases, connections must be exposed to potential human contact. Product operators in these circumstances must be trained to protect themselves from the risk of electric shock. If the circuit is capable of operating at or above 1000 V, no conductive part of the circuit may be exposed.

Do not connect switching cards directly to unlimited power circuits. They are intended to be used with impedance-limited sources. NEVER connect switching cards directly to AC mains. When connecting sources to switching cards, install protective devices to limit fault current and voltage to the card.

Before operating an instrument, ensure that the line cord is connected to a properly-grounded power receptacle. Inspect the connecting cables, test leads, and jumpers for possible wear, cracks, or breaks before each use.

When installing equipment where access to the main power cord is restricted, such as rack mounting, a separate main input power disconnect device must be provided in close proximity to the equipment and within easy reach of the operator.

For maximum safety, do not touch the product, test cables, or any other instruments while power is applied to the circuit under test. ALWAYS remove power from the entire test system and discharge any capacitors before: connecting or disconnecting cables or jumpers, installing or removing switching cards, or making internal changes, such as installing or removing jumpers.

Do not touch any object that could provide a current path to the common side of the circuit under test or power line (earth) ground. Always make measurements with dry hands while standing on a dry, insulated surface capable of withstanding the voltage being measured.

For safety, instruments and accessories must be used in accordance with the operating instructions. If the instruments or accessories are used in a manner not specified in the operating instructions, the protection provided by the equipment may be impaired.

Do not exceed the maximum signal levels of the instruments and accessories. Maximum signal levels are defined in the specifications and operating information and shown on the instrument panels, test fixture panels, and switching cards.

When fuses are used in a product, replace with the same type and rating for continued protection against fire hazard.

Chassis connections must only be used as shield connections for measuring circuits, NOT as protective earth (safety ground) connections.

If you are using a test fixture, keep the lid closed while power is applied to the device under test. Safe operation requires the use of a lid interlock.

If a  screw is present, connect it to protective earth (safety ground) using the wire recommended in the user documentation.

The  symbol on an instrument means caution, risk of hazard. The user must refer to the operating instructions located in the user documentation in all cases where the symbol is marked on the instrument.

The  symbol on an instrument means warning, risk of electric shock. Use standard safety precautions to avoid personal contact with these voltages.

The  symbol on an instrument shows that the surface may be hot. Avoid personal contact to prevent burns.

The  symbol indicates a connection terminal to the equipment frame.

If this  symbol is on a product, it indicates that mercury is present in the display lamp. Please note that the lamp must be properly disposed of according to federal, state, and local laws.

The **WARNING** heading in the user documentation explains hazards that might result in personal injury or death. Always read the associated information very carefully before performing the indicated procedure.

The **CAUTION** heading in the user documentation explains hazards that could damage the instrument. Such damage may invalidate the warranty.

The **CAUTION** heading with the  symbol in the user documentation explains hazards that could result in moderate or minor injury or damage the instrument. Always read the associated information very carefully before performing the indicated procedure. Damage to the instrument may invalidate the warranty.

Instrumentation and accessories shall not be connected to humans.

Before performing any maintenance, disconnect the line cord and all test cables.

To maintain protection from electric shock and fire, replacement components in mains circuits — including the power transformer, test leads, and input jacks — must be purchased from Keithley. Standard fuses with applicable national safety approvals may be used if the rating and type are the same. The detachable mains power cord provided with the instrument may only be replaced with a similarly rated power cord. Other components that are not safety-related may be purchased from other suppliers as long as they are equivalent to the original component (note that selected parts should be purchased only through Keithley to maintain accuracy and functionality of the product). If you are unsure about the applicability of a replacement component, call a Keithley office for information.

Unless otherwise noted in product-specific literature, Keithley instruments are designed to operate indoors only, in the following environment: Altitude at or below 2,000 m (6,562 ft); temperature 0 °C to 50 °C (32 °F to 122 °F); and pollution degree 1 or 2.

To clean an instrument, use a cloth dampened with deionized water or mild, water-based cleaner. Clean the exterior of the instrument only. Do not apply cleaner directly to the instrument or allow liquids to enter or spill on the instrument. Products that consist of a circuit board with no case or chassis (e.g., a data acquisition board for installation into a computer) should never require cleaning if handled according to instructions. If the board becomes contaminated and operation is affected, the board should be returned to the factory for proper cleaning/servicing.

Safety precaution revision as of June 2017.

Table of contents

Introduction	1-1
Welcome	1-1
Introduction to this manual	1-2
Extended warranty	1-2
Contact information	1-2
Organization of manual sections	1-2
Applications	1-3
Front-panel overview	2-1
Power the instrument on or off	2-1
Front-panel overview	2-3
Turn the 2470 output on or off	2-5
Touchscreen display	2-6
Select items on the touchscreen	2-6
Interactive swipe screens	2-7
Menu overview	2-10
Store measurements on a USB flash drive	2-10
Save screen captures to a USB flash drive	2-11
Using a remote interface	3-1
Remote communications interfaces	3-1
Supported remote interfaces	3-1
GPIB communications	3-2
Install the GPIB driver software	3-2
Install the GPIB cards in your computer	3-2
Connect GPIB cables to your instrument	3-2
Set the GPIB address	3-4
LAN communications	3-4
Set up LAN communications on the instrument	3-5
Set up LAN communications on the computer	3-6
USB communications	3-7
Connect a computer to the 2470 using USB	3-8
Communicate with the instrument	3-8
Using the web interface	3-12
LAN troubleshooting suggestions	3-13
Web interface Home page	3-14
Identify the instrument	3-14
Review events in the event log	3-15
Determining the command set you will use	3-15

Making basic front-panel measurements	4-1
Introduction	4-1
Equipment required for this application.....	4-2
Device connections	4-2
Make front-panel measurements	4-3
How to make front-panel measurements	4-3
Leakage current and insulation resistance	5-1
Introduction	5-1
Equipment required.....	5-2
Set up remote communications	5-2
Device connections	5-2
Measuring leakage current	5-4
Set up the leakage current application using the front panel.....	5-5
View the measurements on the front-panel graph.....	5-6
Set up the leakage current application using SCPI commands.....	5-7
Set up the leakage current application using TSP commands	5-7
Measuring insulation resistance.....	5-9
Set up the insulation resistance application using the front panel.....	5-10
Viewing the measurements on the front-panel graph.....	5-11
Set up the application using SCPI commands	5-12
Set up the application using TSP commands.....	5-13
Measure I-V characteristics of FETs	6-1
Introduction	6-1
Equipment required.....	6-2
Set up remote communications	6-2
Set up external hardware triggers.....	6-3
Connections for the SCPI command set	6-3
Connections for the TSP command set.....	6-4
Device connections.....	6-5
Drain leakage current measurement device connections.....	6-5
Subthreshold current or drain family of curves measurement device connections.....	6-7
Remote control of FET testing using SCPI commands	6-8
Set up the application using SCPI commands with the trigger model	6-8
Set up the application using SCPI commands in a linear sweep.....	6-11
Remote control of FET testing using TSP commands.....	6-13
Set up the drain leakage current measurement using TSP commands	6-13
Set up a subthreshold current measurement using TSP commands	6-15
Set up the drain family of curves measurement using TSP commands	6-18
Troubleshooting FAQs	7-1
About this section.....	7-1

Where can I find updated drivers?	7-1
How do I upgrade the firmware?	7-2
Why can't the 2470 read my USB flash drive?	7-2
How do I change the command set?	7-3
Why am I getting a 5074 event code?	7-4
How do I save the present state of the instrument?	7-4
Why did my settings change?	7-5
What are the Quick Setup options?	7-6
Next steps	8-1
Additional 2470 information	8-1

Introduction

In this section:

Welcome	1-1
Introduction to this manual	1-2
Extended warranty	1-2
Contact information	1-2
Organization of manual sections	1-2
Applications	1-3

Welcome

Thank you for choosing a Keithley Instruments product. The 2470 High Voltage SourceMeter Instrument is a precise, low-noise instrument that combines a stable DC power supply with a repeatable, high-impedance multimeter. This instrument features intuitive setup and control, enhanced signal quality and range, and better resistivity and resistance capabilities than similar products on the market.

With its 1100 V and 10 fA capability, the 2470 is optimized for characterizing and testing high voltage, low leakage devices, materials, and modules, such as silicon carbide (SiC), gallium nitride (GaN), power MOSFETs, transient suppression devices, circuit protection devices, power modules, and batteries.

SMU instruments offer a highly flexible, four-quadrant voltage and current source/load coupled with precision voltage and current measurements. The 2470 instrument can be used as a:

- Precision power supply with voltage and current readback
- True current source
- Digital multimeter (DCV, DCI, ohms, and power with 6½-digit resolution)
- Precision electronic load
- Pulse generator
- Trigger controller

Introduction to this manual

This manual provides detailed applications to help you achieve success with your Keithley Instruments 2470. In addition, this manual provides information about the basics of the front panel to familiarize you with the instrument.

This manual presents an overview of each application, followed by instructions to complete the application using the front panel, SCPI code, TSP code, or Keithley KickStart Startup Software.

More information about the commands that are used in these applications is available. Refer to the SCPI and TSP command reference sections of the *Model 2470 Reference Manual*. This manual is on tek.com/keithley.

Extended warranty

Additional years of warranty coverage are available on many products. These valuable contracts protect you from unbudgeted service expenses and provide additional years of protection at a fraction of the price of a repair. Extended warranties are available on new and existing products. Contact your local Keithley Instruments office, sales partner, or distributor for details.

Contact information

If you have any questions after you review the information in this documentation, please contact your local Keithley Instruments office, sales partner, or distributor. You can also call the corporate headquarters of Keithley Instruments (toll-free inside the U.S. and Canada only) at 1-800-935-5595, or from outside the U.S. at +1-440-248-0400. For worldwide contact numbers, visit the Keithley Instruments website (tek.com/keithley).

Organization of manual sections

This manual is organized into the following sections:

- [Front-panel overview](#) (on page 2-1): Describes the basics of using the front-panel interface.
- [Using a remote interface](#) (on page 3-1): Describes the basics of remote communications and using the instrument web interface.
- Application examples (see below): Provides detailed examples of how to use the 2470 in some typical situations.
- [Troubleshooting FAQs](#) (on page 7-1): Provides answers to frequently asked questions to help you troubleshoot common problems encountered with the 2470.
- [Next steps](#) (on page 8-1): Provides information about additional resources that can help you use the 2470.

The PDF version of this manual contains bookmarks for each section. The manual sections are also listed in the Table of Contents at the beginning of this manual.

For more information about bookmarks, see Adobe® Acrobat® or Reader® help.

Applications

This manual provides application examples that show you how to perform tests from the front panel and over a remote interface. These applications are presented after the summary information about the 2470. The applications include:

- [Making basic front-panel measurements](#) (on page 4-1): Demonstrates the basic measurement functionality using a single 2470 and a two-terminal device under test (DUT).
- [Leakage current and insulation resistance](#) (on page 5-1): Demonstrates how to use a 2470 to make high resistance measurements on two-terminal DUTs.
- [Measure I-V characteristics of FETs](#) (on page 6-1): Demonstrates how to use one or two 2470s to verify and characterize field-effect transistors (FETs).

Front-panel overview

In this section:

Power the instrument on or off	2-1
Front-panel overview.....	2-3
Turn the 2470 output on or off.....	2-5
Touchscreen display	2-6
Store measurements on a USB flash drive	2-10
Save screen captures to a USB flash drive	2-11

Power the instrument on or off

Follow the steps below to connect the 2470 to line power and turn on the instrument. The 2470 operates from a line voltage of 100 V to 240 V at a frequency of 50 Hz or 60 Hz. It automatically senses line voltage and frequency. Make sure the operating voltage in your area is compatible.

You must turn on the 2470 and allow it to warm up for at least one hour to achieve rated accuracies.

CAUTION

Operating the instrument on an incorrect line voltage may cause damage to the instrument, possibly voiding the warranty.

WARNING

The power cord supplied with the 2470 contains a separate protective earth (safety ground) wire for use with grounded outlets. When proper connections are made, the instrument chassis is connected to power-line ground through the ground wire in the power cord. In addition, a redundant protective earth connection is provided through a screw on the rear panel. This terminal should be connected to a known protective earth. In the event of a failure, not using a properly grounded protective earth and grounded outlet may result in personal injury or death due to electric shock.

Do not replace detachable mains supply cords with inadequately rated cords. Failure to use properly rated cords may result in personal injury or death due to electric shock.

To connect the power cord:

1. Make sure that the front-panel POWER switch is in the off (O) position.
2. Connect the female end of the supplied power cord to the AC receptacle on the rear panel.
3. Connect the male end of the power cord to a grounded AC outlet.

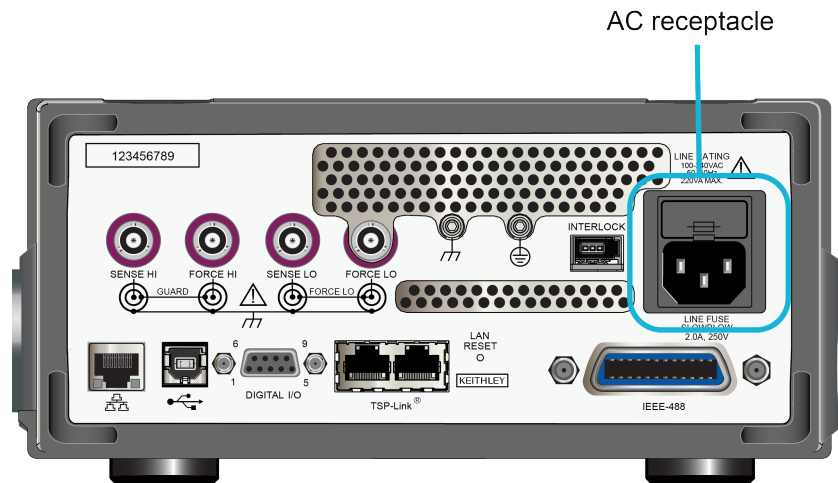
Figure 1: Model 2470 AC receptacle on rear panel**To turn a 2470 on or off:**









1. Before turning the instrument on, disconnect any devices under test (DUTs) from the 2470.
2. To turn your instrument on, press the front-panel **POWER** switch to place it in the on (I) position. The instrument displays a status bar as it powers on. The home screen is displayed when power on is complete.
3. To turn your instrument off, press the front-panel **POWER** switch to place it in the off (O) position.











Front-panel overview

The front panel of the 2470 is shown below. Descriptions of the controls on the front panel follow the figure.

Figure 2: Model 2470 front panel

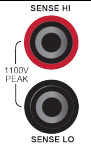
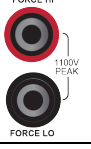

Control	Graphic	Description
POWER switch	 POWER	Turns the instrument on or off. To turn the instrument on, press the power switch so that it is in the on position (I). To turn it off, press the power switch so that it is in the off position (O).
HOME key		Returns the display to the home screen.
MENU key		Opens the main menu. Press the icons on the main menu to open source, measure, views, trigger, scripts, and system screens.
QUICKSET key		Opens a menu of preconfigured setups, including voltmeter, ammeter, ohmmeter, and power supply. Also allows you to choose source and measure functions and adjust performance for better resolution or speed.
HELP key		Opens help for the area or item that is selected on the display. If there is no selection when you press the HELP key, it displays overview information for the screen you are viewing.
USB port		Saves reading buffer data and screen snapshots to a USB flash drive. You can also store and retrieve scripts to and from a USB flash drive. The flash drive must be formatted as a FAT or FAT32 drive.
Touchscreen		The 2470 has a high-resolution, five-inch color touchscreen display. The touchscreen accesses swipe screens and menu options. You can access additional interactive screens by pressing the front-panel MENU , QUICKSET , and FUNCTION keys.
Navigation control		Turning the navigation control: Moves the cursor to highlight a list value or menu item so that you can select it. Turning the control when the cursor is in a value entry field increases or decreases the value in the field. Pressing the navigation control: Selects the highlighted choice or allows you to edit the selected field.
ENTER key		Selects the highlighted choice or allows you to edit the selected field.

Control	Graphic	Description
EXIT key		Returns to the previous screen or closes a dialog box. For example, press the EXIT key when the main menu is displayed to return to the home screen. When you are viewing a subscreen (for example, the Event Log screen), press the EXIT key to return to the main menu screen.
FUNCTION key		Displays instrument functions. To select a function, touch the function name on the screen.
TRIGGER key		Accesses trigger-related settings and operations. The action of the TRIGGER key depends on the instrument state.
OUTPUT ON/OFF switch		Turns the output source on or off. The switch illuminates when the source output is on.
REMOTE LED indicator	REMOTE 	Illuminates when the instrument is controlled through a remote interface.
LAN LED indicator	LAN 	Illuminates when the instrument is connected to a local area network (LAN).
1588 LED indicator	1588 	Illuminates when the instrument is connected to an IEEE-1588 compliant device. Note that 1588 functionality is not supported at this time. This functionality will be made available with a firmware update. See the <i>2470 Release Notes</i> on the tek.com/keithley for details.
INTERLOCK LED indicator	INTERLOCK 	Illuminates when the interlock is enabled.
SENSE terminals		Use the SENSE HI and SENSE LO terminal connections to measure voltage at the device under test (DUT). When you use sense leads, measurement of the voltage drop across the force leads is eliminated. This produces more accurate voltage sourcing and measurement at the DUT.
FORCE terminals		Use FORCE HI and FORCE LO terminal connections to source or sink voltage or current to or from a device under test (DUT).
FRONT/REAR TERMINALS switch		Activates the terminals on the front or rear panel. When the front-panel terminals are active, a green "F" is visible to the left of the FRONT/REAR switch. When the rear-panel terminals are active, a yellow "R" is visible to the left of the switch.
Chassis connection		Banana jack connector that provides a chassis connection.

Turn the 2470 output on or off

You can turn the 2470 output on from the front panel or by sending remote commands.

WARNING

Turning the 2470 output off does not place the instrument in a safe state (an interlock is provided for this function).

Hazardous voltages may be present on all output and guard terminals. To prevent electrical shock that could cause injury or death, never make or break connections to the 2470 while the instrument is powered on. Turn off the equipment from the front panel or disconnect the main power cord from the rear of the 2470 before handling cables. Putting the equipment into an output-off state does not guarantee that the outputs are powered off if a hardware or software fault occurs.

When the source of the instrument is turned off, it may not completely isolate the instrument from the external circuit. You can use the Output Off setting to place the 2470 in a known, noninteractive state during idle periods, such as when you are changing the device under test. The output-off states that can be selected for a 2470 are normal, high-impedance, zero, or guard.

See "Output-off state" in the *2470 Reference Manual* for additional details.

Using the front panel:

Press the **OUTPUT ON/OFF** switch. The instrument is in the output-on state when the switch is illuminated. The instrument is in the output-off state when the switch is not illuminated.

Using SCPI commands:

To turn the output on, send the command:

```
:OUTPut:STATE ON
```

To turn the output off, send the command:

```
:OUTPut:STATE OFF
```

Using TSP commands:

To turn the output on, send the command:

```
smu.source.output = smu.ON
```

To turn the output off, send the command:

```
smu.source.output = smu.OFF
```

Touchscreen display

The touchscreen display gives you quick front-panel access to source and measure settings, system configuration, instrument and test status, reading buffer information, and other instrument functionality. The display has multiple swipe screens that you can access by swiping the front panel. You can access additional interactive screens by pressing the front-panel MENU, QUICKSET, and FUNCTION keys.

CAUTION

Do not use sharp metal objects, such as tweezers or screwdrivers, or pointed objects, such as pens or pencils, to touch the touchscreen. It is strongly recommended that you use only fingers to operate the instrument. Use of clean-room gloves to operate the touchscreen is supported.

Select items on the touchscreen

To select an item on the displayed screen, do one of the following:

- Touch it with your finger
- Turn the navigation control to highlight the item, and then press the navigation control to select it

The following topics describe the 2470 touchscreen in more detail.

Some of the interactive screens have additional options that are only visible when you scroll down the screen. A scroll indicator on the right side of the touchscreen identifies these screens. Swipe the screen up or down to view the additional options.

The figure below shows a screen with a scroll bar.

Figure 3: Touchscreen window with a scroll bar indicator

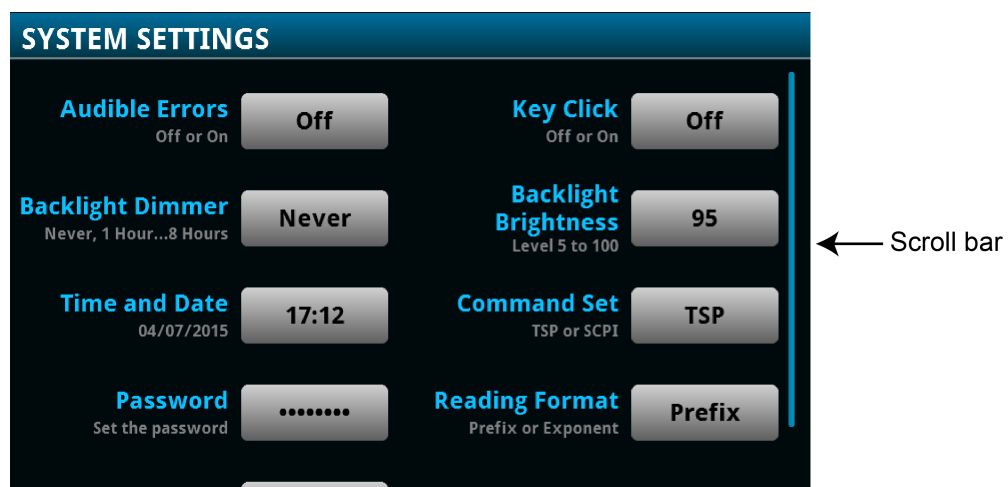

Interactive swipe screens



The 2470 touchscreen display has multiple screens that you can access by swiping left or right on the lower half of the display. The options available in the swipe screens are described in the following topics.

Swipe screen heading bar

The heading bar of the swipe screen contains the following options.

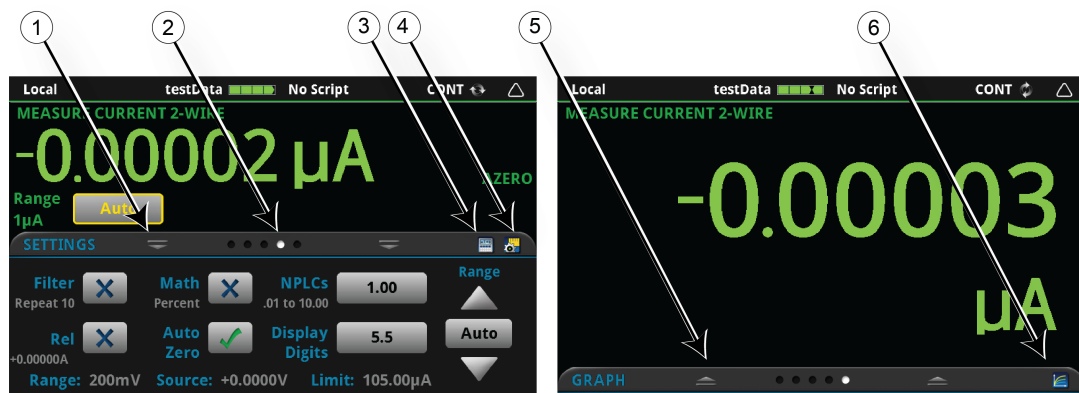
Figure 4: Swipe screens, maximized and minimized



#	Screen element	Description
1	Minimize indicator	You can swipe down to minimize the swipe screens.
2	Swipe screen indicator	Each circle represents one swipe screen. As you swipe right or left, a different circle changes color, indicating where you are in the screen sequence. Select a circle to move the swipe screen without swiping.
3	Calculations shortcut 	Select to open the CALCULATION SETTINGS menu.
4	Measure Settings shortcut 	Select to open the MEASURE SETTINGS menu for the selected function.
5	Restore indicator	Indicates that you can swipe up to display the swipe screen.
6	Graph shortcut 	Select to open the Graph screen.

SOURCE swipe screen

The SOURCE swipe screen shows the present value of the source and the set values for source, source range, and source limit. You can change the set values from the front panel by selecting the buttons on this screen.

Figure 5: SOURCE swipe screen



Source function indicators on the right side of the screen signify settings that affect the displayed source value.

- **MEAS:** Source readback is on and the value shown is the measured value of the source.
- **PROG:** Source readback is off and the value shown is the programmed source value. If the output is off, the displayed source value is replaced with **Output Off**.

The icon on the right side of the swipe screen heading bar is a shortcut to the full SOURCE SETTINGS menu.

SETTINGS swipe screen

The SETTINGS swipe screen gives you front-panel access to some instrument settings. It shows you the present settings and allows you to change, enable, or disable them quickly.

Figure 6: SETTINGS swipe screen

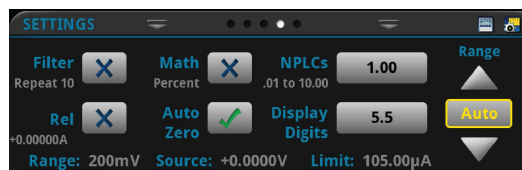

To disable or enable a setting, select the box next to the setting so that it shows an X (disabled) or a check mark (enabled).

The icons on the right side of the swipe screen heading bar are shortcuts to the CALCULATIONS SETTINGS and MEASURE SETTINGS menus.

For descriptions of the settings, use the navigation control to select the button, then press the **HELP** key.

STATISTICS swipe screen

The STATISTICS swipe screen contains information about the readings in the active reading buffer. When the reading buffer is configured to fill continuously and overwrite old data with new data, the buffer statistics include the data that was overwritten. To get statistics that do not include data that has been overwritten, define a large buffer size that will accommodate the number of readings you will make. You can use the **Clear Active Buffer** button on this screen to clear the data from the active reading buffer.

Figure 7: STATISTICS swipe screen

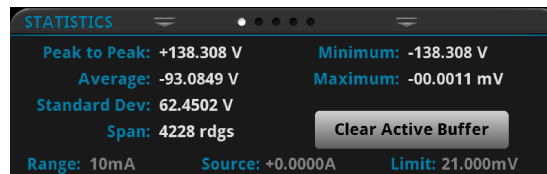

USER swipe screen

If you program custom text, it is displayed on the USER swipe screen. For example, you can program the 2470 to show that a test is in process. For details about using remote commands to program the display, refer to Customizing a message for the USER swipe screen.

Figure 8: USER swipe screen

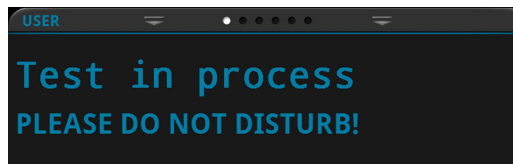

GRAPH swipe screen

The GRAPH swipe screen shows a graphical representation of the readings in the presently selected reading buffer.

Figure 9: GRAPH swipe screen



To view the graph in the full screen and to access graph settings, select the graph icon on the right side of the swipe screen header. You can also open the full-function Graph screen by pressing the **MENU** key and selecting **Graph** under Views.

For more information about graphing measurements, see "Graphing" in the *Model 2470 Reference Manual*.

Menu overview

To access the main menu, press the **MENU** key on the 2470 front panel. The figure below shows the organization of the main menu.

Figure 10: 2470 main menu

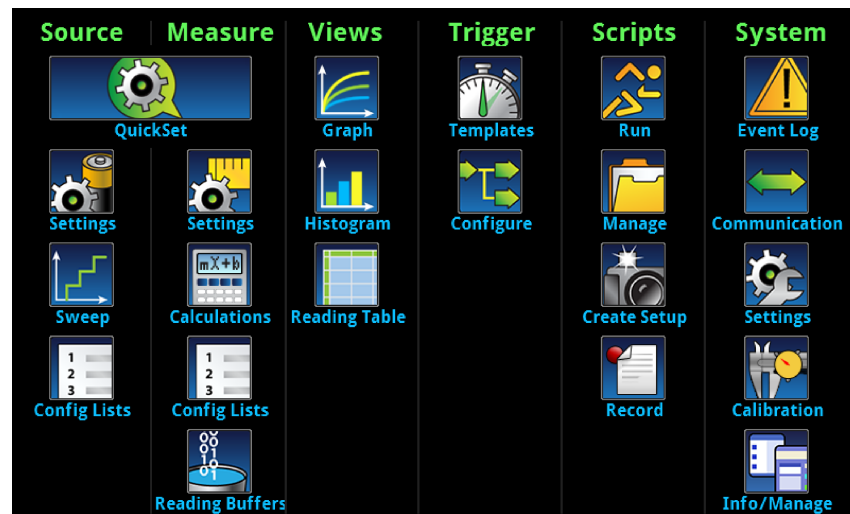

The main menu includes submenus that are labeled in green across the top of the display. Selecting an option in a submenu opens an interactive screen.

Store measurements on a USB flash drive

If there is measurement data in the buffer, you can copy it from the 2470 to a USB flash drive. The information is saved in the CSV file format.

To store measurement data:

1. Insert a flash drive into the front-panel USB port.
2. Press the **MENU** key.
3. In the Measure column, select **Reading Buffers**.
4. Select the buffer that you want to save.
5. Select **Save to USB**.
6. Enter a name for the new file.
7. Select the **OK** button on the displayed keyboard.
8. Select **Yes** to confirm saving the file.
9. Select **OK** to close the dialog box.

Save screen captures to a USB flash drive

You can save a screen capture of the front-panel display to a graphic file. The instrument saves the graphic file to the USB flash drive in the PNG file format.

To save a screen capture:

1. Insert a USB flash drive in the USB port on the front panel of the instrument.
2. Navigate to the screen you want to capture.
3. Press the **HOME** and **ENTER** keys. The instrument displays "Saving screen capture."
4. Release the keys.

Using a remote interface

In this section:

Remote communications interfaces	3-1
Supported remote interfaces	3-1
GPIB communications.....	3-2
LAN communications	3-4
USB communications	3-7
Using the web interface.....	3-12
Determining the command set you will use.....	3-15

Remote communications interfaces

You can choose from one of several communication interfaces to send commands to and receive responses from the 2470.

You can control the 2470 from only one communications interface at a time. The first interface on which the instrument receives a message takes control of the instrument. If another interface sends a message, that interface can take control of the instrument. You may need to enter a password to change the interface, depending on the access mode.

The 2470 automatically detects the type of communications interface (LAN, USB, or GPIB) when you connect to the respective port on the rear panel of the instrument. In most cases, you do not need to configure anything on the instrument. In addition, you do not need to reboot if you change the type of interface that is connected.

Supported remote interfaces

The 2470 supports the following remote interfaces:

- **GPIB:** IEEE-488 instrumentation general purpose interface bus
- **Ethernet:** Local-area-network communications
- **USB:** Type B USB port
- **TSP-Link:** A high-speed trigger synchronization and communications bus that test system builders can use to connect multiple instruments in a master-and-subordinate configuration

For details about TSP-Link, see "TSP-Link System Expansion Interface" in the *Model 2470 Reference Manual*.

GPIB communications

The 2470 GPIB interface is IEEE Std 488.1 compliant and supports IEEE Std 488.2 common commands and status model topology.

You can have up to 15 devices connected to a GPIB interface, including the controller. The maximum cable length is the lesser of either:

- The number of devices multiplied by 2 m (6.5 ft)
- 20 m (65.6 ft)

You may see erratic bus operation if you ignore these limits.

Install the GPIB driver software

Check the documentation for your GPIB controller for information about where to acquire drivers. Keithley Instruments also recommends that you check the website of the GPIB controller for the latest version of drivers or software.

It is important that you install the drivers before you connect the hardware. This prevents associating the incorrect driver to the hardware.

Install the GPIB cards in your computer

Refer to the documentation from the GPIB controller vendor for information about installing the GPIB controllers.

Connect GPIB cables to your instrument

To connect a 2470 to the GPIB interface, use a cable equipped with standard GPIB connectors, as shown below.

Figure 11: GPIB connector

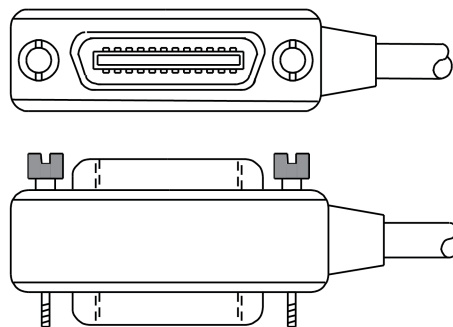

To allow many parallel connections to one instrument, stack the connectors. Each connector has two screws on it to ensure that connections remain secure. The figure below shows a typical connection diagram for a test system with multiple instruments.

CAUTION

To avoid possible mechanical damage, stack no more than three connectors on any one instrument. To minimize interference caused by electromagnetic radiation, use only shielded GPIB cables. Contact Keithley Instruments for shielded cables.

Figure 12: IEEE-488 connection example

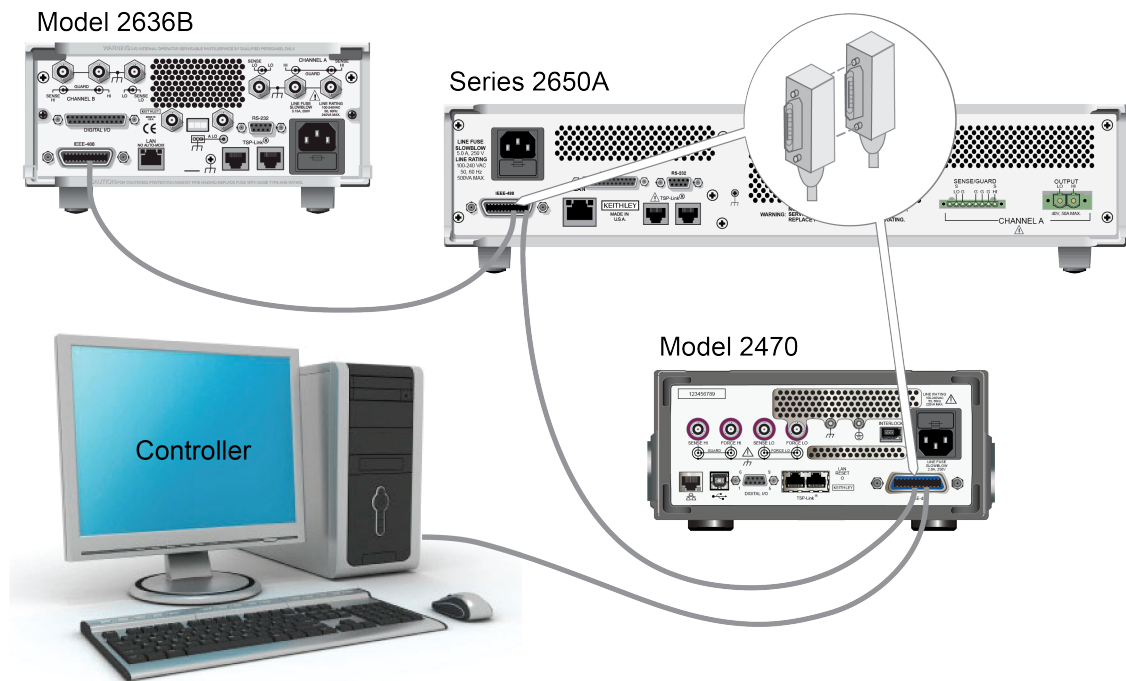

To connect the GPIB cable to the instrument:

1. Align the cable connector with the connector on the 2470 rear panel.
2. Attach the connector. Tighten the screws securely but do not overtighten them.
3. Connect any additional connectors from other instruments, as required for your application.
4. Make sure that the end of the cable is properly connected to the controller.

Set the GPIB address

The default GPIB address is 18. You can set the address from 1 to 30 if it is unique in the system. This address cannot conflict with an address that is assigned to another instrument or to the GPIB controller.

NOTE

GPIB controllers are usually set to 0 or 21. To be safe, do not configure any instrument to have an address of 21.

The instrument saves the address in nonvolatile memory. It does not change when you send a reset command or when you turn the power off and on again.

To set the GPIB address from the front panel:

1. Press the **MENU** key.
2. Select **Communication**.
3. Select the **GPIB** tab.
4. Set the **GPIB Address**.
5. Select **OK**.

NOTE

You can also set the GPIB address using remote commands. Set the GPIB address with the SCPI command `:SYSTem:GPIB:ADDRess` or the TSP command `gpib.address`.

LAN communications

You can communicate with the instrument using a local area network (LAN).

When you connect using a LAN, you can use a web browser to access the internal web page of the instrument and change some of the instrument settings. For more information, see [Using the web interface](#) (on page 3-12).

The 2470 is a version 1.4 Core 2011 compliant instrument that supports TCP/IP and complies with IEEE Std 802.3 (ethernet LAN). There is one LAN port (located on the rear panel of the instrument) that supports full connectivity on a 10 Mbps or 100 Mbps network. The 2470 automatically detects the speed.

The 2470 also supports Multicast DNS (mDNS) and DNS Service Discovery (DNS-SD), which are useful on a LAN with no central administration.

NOTE

Contact your network administrator to confirm your specific network requirements before setting up a LAN connection.

If you have problems setting up the LAN, refer to [LAN troubleshooting suggestions](#) (on page 3-13).

Set up LAN communications on the instrument

This section describes how to set up manual or automatic LAN communications on the instrument.

Check communication settings

Before setting up the LAN configuration, you can check the communication settings on the instrument without making any changes.

To check communication settings on the instrument:

1. Press the **MENU** key.
2. Under System, select **Communication**. The SYSTEM COMMUNICATIONS window opens.
3. Select LAN to see the settings for that interface.

Set up automatic LAN configuration

If you are connecting to a LAN that has a DHCP server or if you have a direct connection between the instrument and a host computer, you can use automatic IP address selection.

If you select Auto, the instrument attempts to get an IP address from a DHCP server. If this fails, it reverts to an IP address in the range of 169.254.1.0 through 169.254.254.255.

NOTE

Both the host computer and the instrument should be set to use automatic LAN configuration. Though it is possible to have one set to manual configuration, it is more complicated to set up.

To set up automatic IP address selection using the front panel:

1. Press the **MENU** key.
2. Under System, select **Communication**.
3. Select the **LAN** tab.
4. For TCP/IP Mode, select **Auto**.
5. Select **Apply Settings** to save your settings.

Set up manual LAN configuration

If necessary, you can set the IP address on the instrument manually.

You can also enable or disable the DNS settings and assign a host name to the DNS server.

NOTE

Contact your corporate information technology (IT) department to secure a valid IP address for the instrument when placing the instrument on a corporate network.

The instrument IP address has leading zeros, but the computer IP address cannot.

To set up manual IP address selection on the instrument:

1. Press the **MENU** key.
2. Under System, select **Communication**.
3. Select the **LAN** tab.
4. For TCP/IP Mode, select **Manual**.
5. Enter the **IP Address**.
6. Enter the **Gateway** address.
7. Enter the **Subnet** mask.
8. Select **Apply Settings** to save your settings.

Set up LAN communications on the computer

This section describes how to set up the LAN communications on your computer.

NOTE

Do not change your IP address without consulting your system administrator. If you enter an incorrect IP address, it can prevent your computer from connecting to your corporate network or it may cause interference with another networked computer.

Record all network configurations before modifying any existing network configuration information on the network interface card. Once the network configuration settings are updated, the previous information is lost. This may cause a problem reconnecting the host computer to a corporate network, particularly if DHCP is disabled.

Be sure to return all settings to their original configuration before reconnecting the host computer to a corporate network. Contact your system administrator for more information.

Verify the LAN connection on the 2470

Make sure that your 2470 is connected to the network by confirming that your instrument was assigned an IP address.

To verify the LAN connection:

1. Press the **MENU** key.
2. Under System, select **Communication**.
3. Select the **LAN** tab.

The green LAN LED on the upper right of the front panel is on when your instrument is connected to the network.

Use the LXI Discovery Tool

To find the IP address of the 2470, use the LXI Discovery Tool, a utility that is available from the Resources tab of the [LXI Consortium website \(Ixistandard.org/\)](http://Ixistandard.org/).

USB communications

To use the rear-panel USB port, you must have the Virtual Instrument Software Architecture (VISA) layer on the host computer. See "How to install the Keithley I/O Layer" in the *Model 2470 Reference Manual* for more information.

VISA contains a USB-class driver for the USB Test and Measurement Class (USBTMC) protocol that, once installed, allows the Microsoft Windows operating system to recognize the instrument.

When you connect a USB device that implements the USBTMC or USBTMC-USB488 protocol to the computer, the VISA driver automatically detects the device. Note that the VISA driver only automatically recognizes USBTMC and USBTMC-USB488 devices. It does not recognize other USB devices, such as printers, scanners, and storage devices.

In this section, "USB instruments" refers to devices that implement the USBTMC or USBTMC-USB488 protocol.

Connect a computer to the 2470 using USB

To communicate from a computer to the instrument you need a USB cable with a USB Type B connector end and a USB type A connector end. You need a separate USB cable for each instrument you plan to connect to the computer at the same time using the USB interface.

To connect an instrument to a computer using USB:

1. Connect the Type A end of the cable to the computer.
2. Connect the Type B end of the cable to the instrument.
3. Turn on the instrument power. When the computer detects the new USB connection, the Found New Hardware Wizard starts.
4. If the "Can Windows connect to Windows Update to search for software?" dialog box opens, select **No**, and then select **Next**.
5. On the "USB Test and Measurement device" dialog box, select **Next**, and then select **Finish**.

Communicate with the instrument

For the instrument to communicate with the USB device, you must use NI-VISA™. VISA requires a resource string in the following format to connect to the correct USB instrument:

```
USB0::0x05e6::0x2470::[serial number]::INSTR
```

Where:

- 0x05e6: The Keithley vendor ID
- 0x2470: The instrument model number
- [serial number]: The serial number of the instrument (the serial number is also on the rear panel)
- INSTR: Use the USBTMC protocol

To determine these parameters, you can run the Keithley Configuration Panel, which automatically detects all instruments connected to the computer.

If you installed the Keithley I/O Layer, you can access the Keithley Configuration Panel through the Microsoft® Windows® Start menu.

To use the Keithley Configuration Panel to determine the VISA resource string:

1. Click **Start > Keithley Instruments > Keithley Configuration Panel**. The Select Operation dialog box is displayed.

Figure 13: Select Operation dialog box

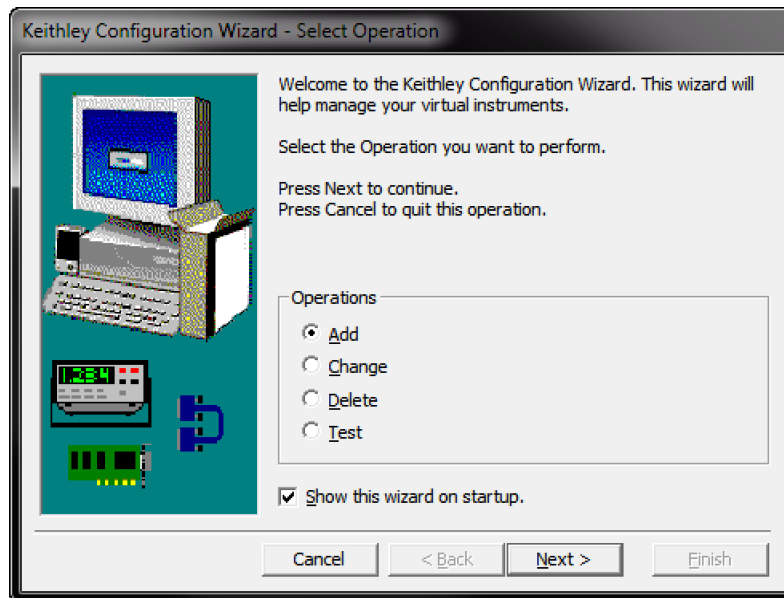

2. Select **Add**.
3. Select **Next**. The Select Communication Bus dialog box is displayed.

Figure 14: Select Communication Bus dialog box

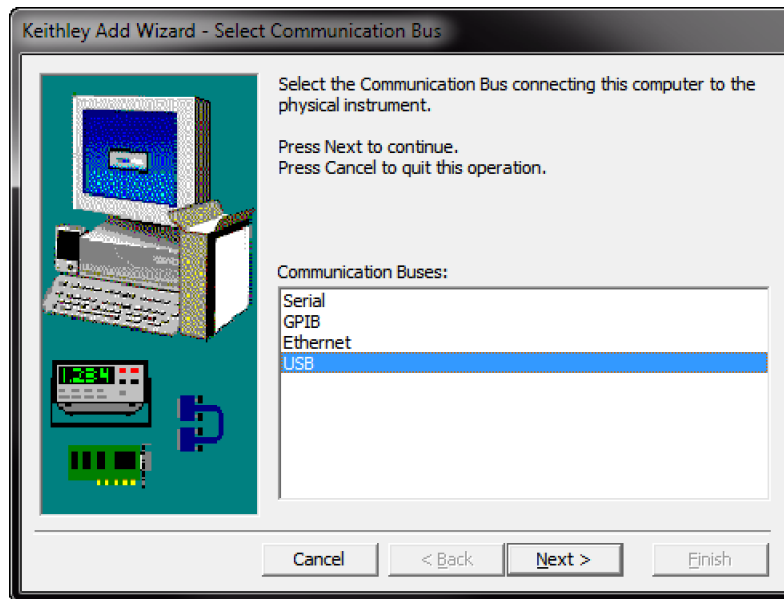

4. Select **USB**.
5. Click **Next**. The Select Instrument Driver dialog box is displayed.

Figure 15: Select Instrument Driver dialog box

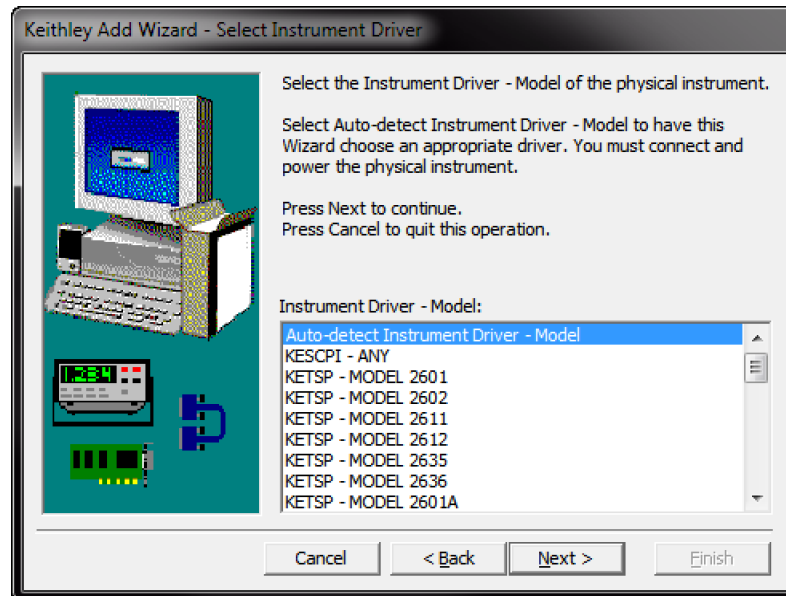

6. Select **Auto-detect Instrument Driver - Model**.
7. Click **Next**. The Configure USB Instrument dialog box is displayed with the detected instrument VISA resource string visible.
8. Click **Next**. The Name Virtual Instrument dialog box is displayed.

Figure 16: Name Virtual Instrument dialog box

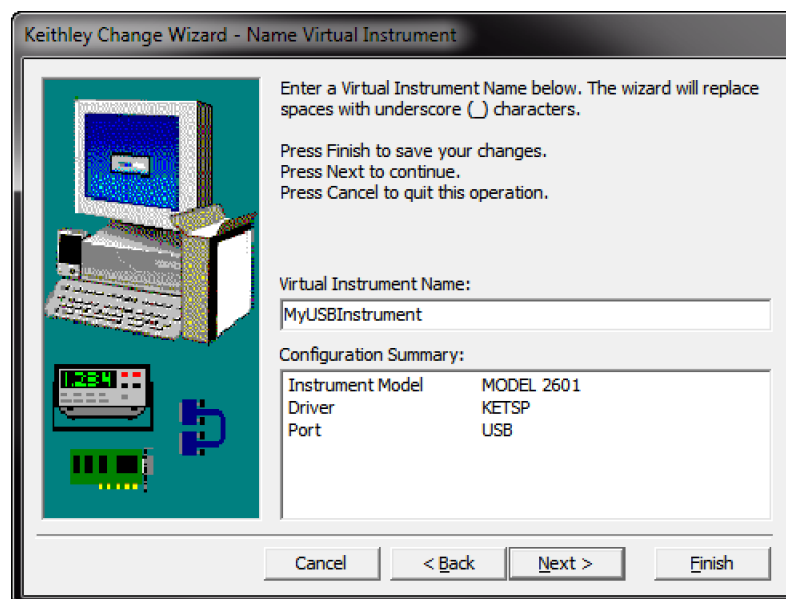

9. In the Virtual Instrument Name box, enter a name that you want to use to refer to the instrument.
10. Select **Finish**.
11. Select **Cancel** to close the Wizard.
12. Save the configuration. From the Keithley Configuration Panel, select **File > Save**.

Verify the instrument through the Keithley Communicator:

1. Click **Start > Keithley Instruments > Keithley Communicator**.
2. Select **File > Open Instrument** to open the instrument you just named.

Figure 17: Keithley Communicator Open an Instrument

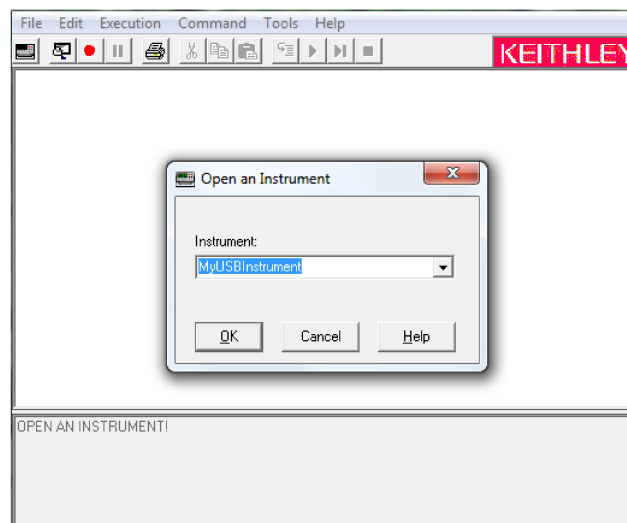

3. Click **OK**.
4. Send a command to the instrument and see if it responds.

NOTE

If you have a full version of NI-VISA on your system, you can run NI-MAX or the VISA Interactive Control utility. See the National Instruments documentation for information.

Using the web interface

The 2470 web interface allows you to make settings and control your instrument through a web page. The web page includes:

- Instrument status.
- The instrument model, serial number, firmware revision, and the last LXI message.
- An ID button to help you locate the instrument.
- A virtual front panel and command interface that you can use to control the instrument.
- Ability to download data from specific reading buffers into a CSV file.
- Administrative options and LXI information.

The instrument web page resides in the firmware of the instrument. Changes you make through the web interface are immediately made in the instrument.

When the LAN and instrument establish a connection, you can open the web page for the instrument.

To access the web interface:

1. Open a web browser on the host computer.
2. Enter the IP address of the instrument in the address box of the web browser. For example, if the instrument IP address is 192.168.1.101, enter 192.168.1.101 in the browser address box.
3. Press **Enter** on the computer keyboard to open the instrument web page.
4. If prompted, enter a user name and password. The default is `admin` for both.

NOTE

If the web page does not open in the browser, see [LAN troubleshooting suggestions](#) (on page 3-13).

NOTE

To find the IP Address of the instrument, press the Communications indicator in the upper left corner of the home screen.

LAN troubleshooting suggestions

If you are unable to connect to the web interface of the instrument, check the following items:

- The network cable is in the LAN port on the rear panel of the instrument, not one of the TSP-Link® ports.
- The network cable is in the correct port on the computer. The LAN port of a laptop may be disabled when the laptop is in a docking station.
- The setup procedure used the configuration information for the correct ethernet card.
- The network card of the computer is enabled.
- The IP address of the instrument is compatible with the IP address on the computer.
- The subnet mask address of the instrument is the same as the subnet mask address of the computer.

You can also try restarting the computer and the instrument.

To restart the instrument:

1. Turn the power to the instrument off, and then on.
2. Wait at least 60 seconds for the network configuration to be completed.

To set up LAN communications:

1. Press the **MENU** key.
2. Under System, select **Communication**.
3. Select the **LAN** tab.
4. Verify the settings.

If the above actions do not correct the problem, contact your system administrator.

Web interface Home page

Figure 18: Model 2470 web interface Home page



The Home page of the instrument provides information about the instrument. It includes:

- The instrument model number, manufacturer, serial number, and firmware revision number.
- The TCP Raw Socket number and Telnet Port number.
- The last LXI message. The history link opens the LXI Home page.
- The ID button, which allows you to identify the instrument. Refer to [Identify the instrument](#) (on page 3-14).

Identify the instrument

If you have a bank of instruments, you can select the ID button to determine which one you are communicating with.

Before trying to identify the instrument, make sure you have a remote connection to the instrument.

To identify the instrument:

1. On the Home page, select the **ID** button. The button turns green and the LAN status indicator on the instrument blinks.
2. Select the **ID** button again to return the button to its original color and return the LAN status indicator to steady on.

Review events in the event log

The event log records all LXI events that the instrument generates and receives. The log includes the following information:

- The EventID column, which shows the identifier of the event that generated the event message.
- The System Timestamp column, which displays the seconds and nanoseconds when the event occurred.
- The Data column, which displays the text of the event message.

To clear the event log and update the information on the screen, select the **Refresh** button.

Determining the command set you will use

You can control the 2470 with command sets that are based on the SCPI or Test Script Processor (TSP®) programming languages. You can change the command set that you use with the 2470. The remote command sets that are available include:

- SCPI: An instrument-specific language built on the SCPI standard.
- TSP: A scripting programming language that contains instrument-specific control commands that can be executed from a stand-alone instrument. You can use TSP to send individual commands or use it to combine commands into scripts.

If you change the command set, reboot the instrument.

You cannot combine the command sets.

NOTE

As delivered from Keithley Instruments, the 2470 is set to work with the SCPI command set.

To set the command set from the front panel:

1. Press the **MENU** key.
2. Under System, select **Settings**.
3. Select the appropriate **Command Set**.

You are prompted to confirm the change to the command set and reboot.

To verify which command set is selected from a remote interface:

Send the command:

```
*LANG?
```

To change to the SCPI command set from a remote interface:

Send the command:

```
*LANG SCPI
```

Reboot the instrument.

To change to the TSP command set from a remote interface:

Send the command:

```
*LANG TSP
```

Reboot the instrument.

Making basic front-panel measurements

In this section:

Introduction	4-1
Equipment required for this application	4-2
Device connections	4-2
Make front-panel measurements.....	4-3

Introduction

You can use the 2470 to source voltage or current and make measurements from the front panel.

NOTE

Make sure you select functions before you make changes to other instrument settings. The options that you have for settings depend on the functions that are active when you make the changes. If you make a change that is not compatible with the active functions, you may get unexpected results or you may receive an event message. Also note that when you select a different function, the instrument clears the buffer. The applications in this manual illustrate the order in which you should perform operations for best results.

In this application, you make measurements on a 10 k Ω resistor by sourcing voltage and measuring current. You can make similar measurements on any two-terminal device under test (DUT) if appropriate source values are used.

Some of the methods you can use to set up the 2470 to make measurements from the front panel include:

- **Use Quicksets.** Press the **QUICKSET** key to open a menu of preconfigured setups, including voltmeter, ammeter, ohmmeter, and power supply setups. It also allows you to choose test functions and adjust performance for better resolution or speed.
- **Select source and measure functions.** Press the **FUNCTION** key to select from a list of source and measure functions.
- **Use menu options.** Press the **MENU** key to open a menu of options.

After selecting your source and measure functions, select buttons on the 2470 Home screen and Settings swipe screens to change the settings.

You will use a combination of these methods to set up the measurement for this application.

Equipment required for this application

Equipment required for this application:

- 2470 High Voltage SourceMeter Instrument
- Two insulated banana cables; you can use the set that is provided with the 2470, the Keithley Instruments Model 8608 High-Performance Clip Lead Set
- One 10 k Ω resistor to test

Device connections

NOTE

Turn the power to the instrument off before attaching connections to the 2470.

Connect the 2470 to the resistor in a 2-wire (local sense) configuration. In this configuration, the device is connected between the FORCE HI and FORCE LO terminals.

The physical connections to the front panel are shown in the following figure.

Figure 19: 2470 2-wire front-panel connections

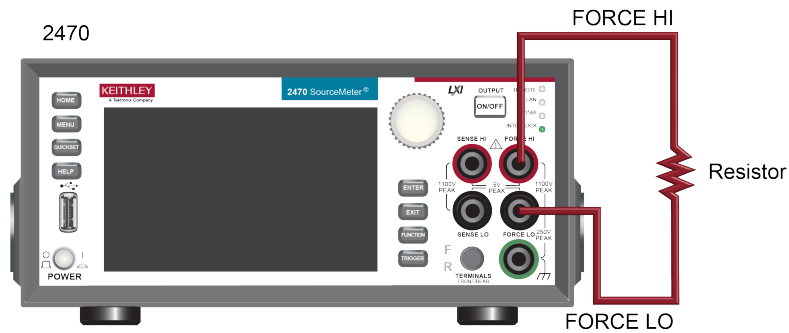

Make front-panel measurements

For this application, you will:

- Select the source and measure functions
- Select the source range
- Set the source value
- Set the source limit
- Select the measurement range
- Turn on the source output
- Observe the readings on the display
- Turn off the source output

How to make front-panel measurements

To make a measurement from the front panel:

1. Press the **POWER** switch on the front panel to turn on the instrument or cycle power if the instrument is already on.
2. On the front panel, press the **FUNCTION** key to verify the source and measure function.
3. Under Source Voltage and Measure, select **Current**.
4. Select the source range. On the home screen, under SOURCE V, select **Range**.
5. Select **20 V**.
6. Select **Source**.
7. Enter **10 V** and select **OK**.
8. Select **Limit**.
9. Enter **10 mA** and select **OK**.
10. In the MEASURE area of the home screen, select **Range**.
11. Select **Auto**.
12. Turn on the output by pressing the **OUTPUT ON/OFF** switch. The OUTPUT indicator light turns on.
13. Observe the readings on the display. For the 10 k Ω resistor, typical display values are:
1.00000 mA
+9.99700 V
14. When measurements are complete, turn the output off by pressing the **OUTPUT ON/OFF** switch. The OUTPUT indicator light turns off.

Leakage current and insulation resistance

In this section:

Introduction	5-1
Equipment required.....	5-2
Set up remote communications.....	5-2
Device connections	5-2
Measuring leakage current.....	5-4
Measuring insulation resistance	5-9

Introduction

Tests to measure the leakage current or insulation resistance of a device are very similar. In both cases, you can apply a fixed bias voltage and measure the resulting current. Depending on the device under test, the measured current is typically very small, usually less than 10 nA.

This application consists of two examples that demonstrate:

- How to use the 2470 to perform leakage current measurements on a capacitor.
- How to use the 2470 to measure insulation resistance between the two conductors of a coaxial cable.

The leakage current application applies a voltage for a specified period. This soak period allows time for the device to charge so that you can make a settled-current measurement. In this application, the resulting current is measured the entire time the device is biased. In other cases, only one reading is required and may be made at the end of the soak period. The application ends by applying 0 volts to discharge the device. The results are returned in units of amperes.

The insulation-resistance application applies voltage and makes a specified number of readings with a set delay between each reading. This allows the measurement to settle, but it is easier to specify exactly how many readings are made. Insulation typically settles much faster than a capacitor device. The results are returned in units of ohms.

The following topics describe how to do these applications from the front panel. They also show how to do them using a remote interface with SCPI and Test Script Processor (TSP®) commands.

Equipment required

- One 2470 High Voltage SourceMeter Instrument
- Two TRX-1100V-X 3-Slot High-Voltage Low-Noise Triaxial Cables (available from Keithley Instruments)
- One high-voltage capacitor for the leakage current application
- One coaxial cable or other device for the insulation resistance application
- One ethernet, GPIB, or USB cable for the SCPI and TSP remote command examples

Set up remote communications

You can run this application from the front panel or any of the supported communication interfaces for the instrument (GPIB, USB, or ethernet).

The following figure shows the rear-panel connection locations for the remote communication interfaces. For additional information about setting up remote communications, see [Remote communications interfaces](#) (on page 3-1).

Figure 20: Model 2470 remote interface connections

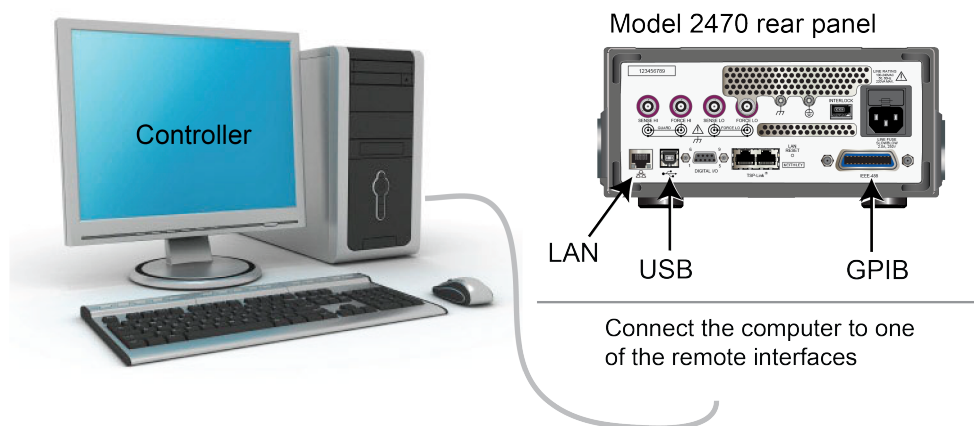

Device connections

Depending on the device under test (DUT), the current measurement is typically very small, usually <10 nA. For any device, measuring leakage current and insulation resistance involves measuring very small values. To get more accurate readings, connect the DUT to the 2470 rear panel with low-noise triaxial cables.

Connect the DUT between the FORCE HI and FORCE LO terminals of the 2470.

The following figure shows schematic diagrams. One shows measuring the leakage current of a capacitor. The other shows measuring the insulator resistance between two conductors of a coaxial cable.

Figure 21: Capacitor leakage and insulation resistance test connection schematics

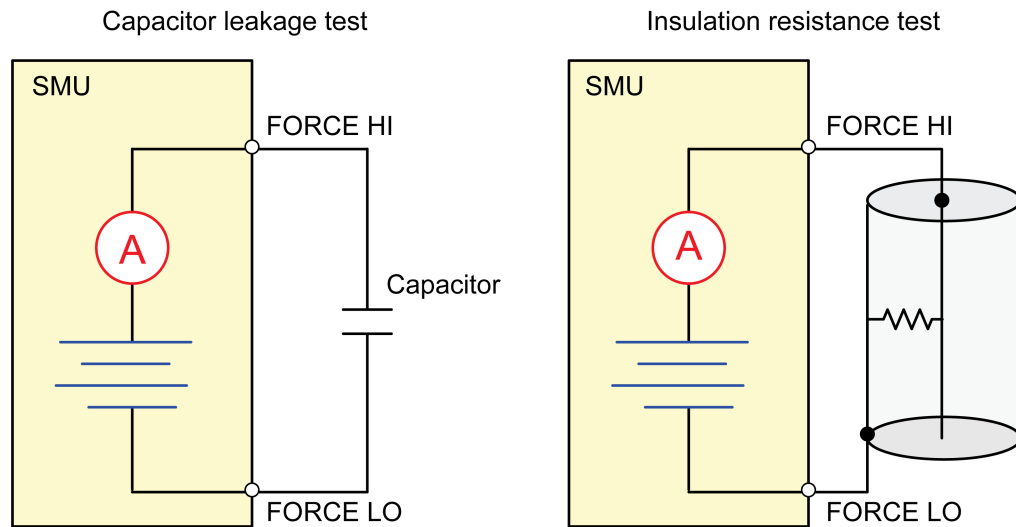

The following figures show the rear-terminal connections to the device under test (DUT) for these applications. If capacitor leakage measurements are noisy, you may need to use the high capacitance mode or add a low leakage forward-biased diode in series with the capacitor.

Figure 22: Rear-panel connections for the leakage current test

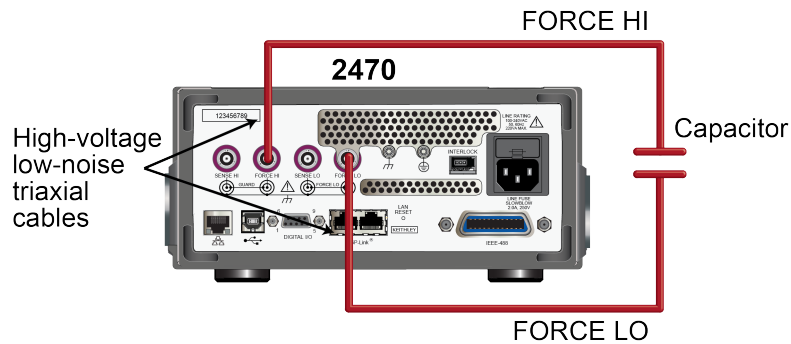
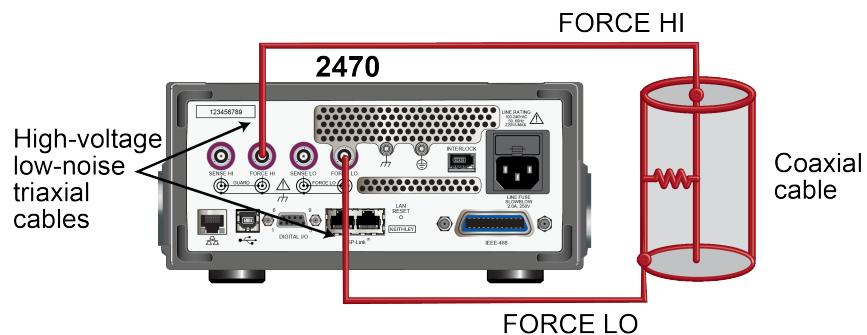

Figure 23: Rear-panel connections insulation resistance test



Measuring leakage current

The following application demonstrates how to use the 2470 to measure the leakage current of a high-voltage 10 μF capacitor by sourcing a voltage and measuring the resulting current using the front panel or over the remote interface. The remote interface examples show SCPI commands and TSP commands.

This application sets the 2470 to source 300 V and measure the resulting leakage current as a function of time. The instrument makes current measurements for a specific period.

For this test, you will:

- Reset the instrument
- Set the instrument to read the rear terminals
- Select the source voltage function and measure current function
- Set the magnitude of the voltage source
- Turn on autoranging
- Set the measure delay
- Use the DurationLoop trigger model template to make readings for a specified period
- Turn on the source output
- Take readings for a specified period
- Turn off the source output

NOTE

When you use the 2470 to measure small current values, ensure that the device under test is electrostatically shielded. If the capacitor rating is greater than 20 nF, enable the high capacitance mode for best results.

For more information about making optimized capacitor leakage measurements and minimizing noisy measurements, see the Keithley Instruments *Low Level Measurements Handbook*, available on the [Keithley Instruments website \(tek.com/keithley\)](http://tek.com/keithley).

Set up the leakage current application using the front panel

To set up the application from the front panel:

1. Use the test leads to make the connection from the capacitor to the rear panel of the 2470, as described in [Device connections](#) (on page 5-2).
2. Reset the 2470.
 - a. Press the **MENU** key.
 - b. Under System, select **Info/Manage**.
 - c. Select **System Reset**, and then select **OK**.
3. Press the **TERMINALS FRONT/REAR** switch to set the instrument to use the rear-panel terminals (R is displayed to the left of the switch).
4. Press the **HOME** key.
5. Press the **FUNCTION** key.
6. Under Source Voltage and Measure, select **Current**.
7. Select the button next to Source (at the bottom of the screen).
8. Enter **300 V** and select **OK**.
9. Select the button next to Limit (at the bottom of the screen).
10. Enter **10 mA** and select **OK**.
11. Press the **MENU** key.
12. Under Trigger, select **Templates**.
13. Set Templates to **DurationLoop**.
14. Set Duration to a soak time of **30s**.
15. Set the delay to **0.2s**. After each reading, a delay of 0.2 s occurs; each reading is not 0.2 s apart.
16. Press the **HOME** key to return to the Home screen.
17. Press the **TRIGGER** key to turn on the output and make measurements. The output is turned off when the measurements are complete.

View the measurements on the front-panel graph

To view the leakage current measurements on the front-panel graph:

1. Press the **MENU** key.
2. Under Views, select **Graph**.
3. Select the **Scale** tab.
4. Under Y-Axis, next to Scale Format, select **Log**.
5. Under X-Axis, next to Method, select **All**.
6. Select the **Graph** tab to view the graph.

The following figure shows the front-panel graph for this application.

Figure 24: Front panel graph of leakage current measurement

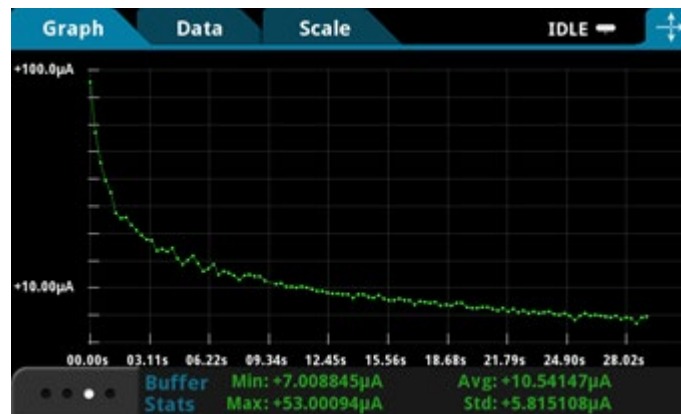

Set up the leakage current application using SCPI commands

The following SCPI code performs a capacitor leakage measurement by sourcing 300 V and measuring the resulting leakage current. The DurationLoop trigger model template applies the voltage for 30 seconds and makes measurements at 200 ms intervals. After the duration time, the capacitor is discharged at 0 V and the output is turned off.

Send the following commands for this example application:

Command	Description
<pre>*RST :SOUR:FUNC VOLT :SOUR:VOLT 300 :SOUR:VOLT:ILIMIT 0.01 :SENSE:FUNC "CURR" :ROUT:TERM REAR :CURR:RANG:AUTO ON :SENSE:CURR:NPLC 1 :TRIG:LOAD "DurationLoop", 30, 0.2 :INIT *WAI :TRAC:ACT? "defbuffer1" :TRAC:DATA? 1, 30, "defbuffer1", READ, REL :SOUR:VOLT 0 :OUTP ON :OUTP OFF</pre>	<ul style="list-style-type: none"> ▪ Reset the 2470. ▪ Set to source voltage. ▪ Set the source voltage to 300 V. ▪ Set the current limit to 10 mA. ▪ Set the instrument to measure current. ▪ Set to use rear-panel terminals. ▪ Set the current range to autorange. ▪ Set the number of power line cycles to 1. ▪ Load the DurationLoop trigger model to run for 30 s with 200 ms delays. ▪ Start the trigger model. ▪ Wait for the measurement to finish. ▪ Query the number of readings in defbuffer1 and return the readings and time. 30 is the queried number of readings. ▪ Discharge the capacitor to 0 V. ▪ Turn on the output. ▪ Turn off the output.

Set up the leakage current application using TSP commands

The following TSP code is designed to be run from Keithley Instruments Test Script Builder (TSB). TSB is a software tool that is available from tek.com/keithley. You can install and use TSB to write code and develop scripts for TSP-enabled instruments. Information about how to use TSB is in the online help for TSB and in the "Introduction to TSP operation" section of the *Model 2470 Reference Manual*.

By default, the 2470 uses the SCPI command set. You must select the TSP command set before sending TSP commands to the instrument.

To enable TSP commands:

1. Press the **MENU** key.
2. Under System, select **Settings**.
3. Set the Command Set to **TSP**.
4. At the prompt to reboot, select **Yes**.

The following TSP code performs a capacitor leakage measurement by sourcing 300 V and measuring the resulting leakage current. The DurationLoop trigger model template applies the voltage for 30 seconds and makes measurements at 200 ms intervals. After the duration time, the capacitor is discharged at 0 V and the output is turned off.

After the code is executed, the measurement results are displayed in the Instrument Console of Test Script Builder. From the Instrument Console, you can copy the data into a spreadsheet for graphing.

Send the following commands for this example application:

```
-- Reset the instrument, which also clears the buffer.
reset()
-- Set up the source function.
smu.source.func = smu.FUNC_DC_VOLTAGE
smu.source.ilimit.level = 10e-3
smu.source.level = 300
-- Set up measure function.
smu.measure.func = smu.FUNC_DC_CURRENT
smu.terminals = smu.TERMINALS_REAR
smu.measure.autorange = smu.ON
smu.measure.nplc = 1
-- Turn on the output and initiate readings.
trigger.model.load("DurationLoop", 30, 0.2)
trigger.model.initiate()
-- Wait for the trigger model to complete.
waitcomplete()
-- Parse index and data into three columns.
print("Rdg #,", "Time (s)", "Current (A)")
for i = 1, defbuffer1.n do
    print(i, defbuffer1.relativetimestamps[i], defbuffer1[i])
end
-- Discharge the capacitor to 0 V and turn off the output.
smu.source.level = 0
smu.source.output = smu.ON
delay(2)
smu.source.output = smu.OFF
```

The graph in the following figure shows the results of this application. Notice the exponential current response of the capacitor as it charges up to 300 V over time.

Figure 25: Leakage current test results

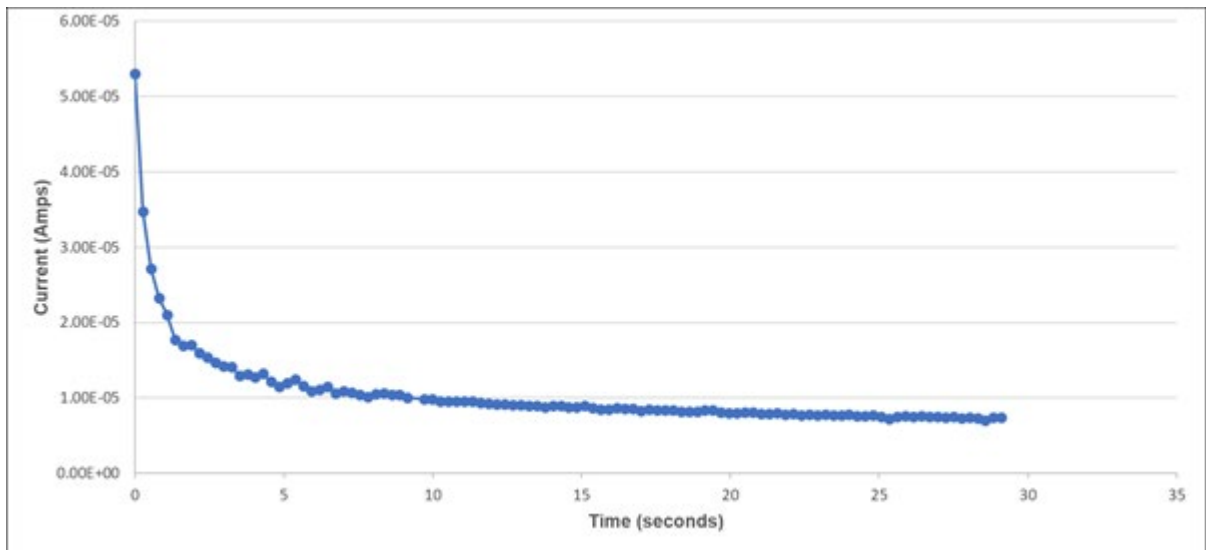

Measuring insulation resistance

The following application demonstrates how to use the 2470 to measure insulator resistance. The application shows how to use the front-panel interface, the remote interface using the SCPI command set, and the remote interface using the Test Script Processor (TSP[®]) command set.

You typically make insulation resistance measurements between traces on a printed circuit board and between conductors in cables and connectors.

This application sets the 2470 to source 700 V and makes 10 resistance readings with a 100 ms interval time. Once the measurements are made, the output is turned off.

For this test, you will:

- Reset the instrument
- Set the instrument to read the rear terminals
- Select the source voltage function and measure resistance function
- Set the magnitude of the voltage source output
- Turn on autoranging
- Use the Simple Loop trigger model template to set the numbers of readings and interval time
- Make readings

Set up the insulation resistance application using the front panel

To set up the application from the front panel:

1. Connect the device under test (DUT) to the rear panel of the 2470, as described in [Device connections](#) (on page 5-2).
2. Reset the 2470.
 - a. Press the **MENU** key.
 - b. Under System, select **Info/Manage**.
 - c. Select **System Reset**, and then select **OK**.
3. Press the **TERMINALS FRONT/REAR** switch to set the instrument to use the rear-panel terminals (R is displayed to the left of the switch).
4. Press the **HOME** key.
5. Press the **FUNCTION** key.
6. Under Source Voltage and Measure, select **Resistance**.
7. Select the button next to Source (at the bottom of the screen).
8. Enter **700 V** and select **OK**.
9. Press the **MENU** key.
10. Under Trigger, select **Templates**.
11. Set Templates to **SimpleLoop**.
12. Set Count to 10.
13. Set Delay to 0.1 seconds.
14. Press the **HOME** key.
15. Press the **OUTPUT ON/OFF** switch to enable the output.
16. Press the **TRIGGER** key to begin taking readings. The resistance measurements appear in the measure area (top half) of the Home screen.
17. Press the **OUTPUT ON/OFF** switch to turn off the output when you are done making measurements.

Viewing the measurements on the front-panel graph

To view the insulation resistance measurements on the front-panel graph:

1. Press the **MENU** key.
2. Under Views, select **Graph**.

The following figure shows the front-panel graph for this application.

Figure 26: Insulation resistance graph

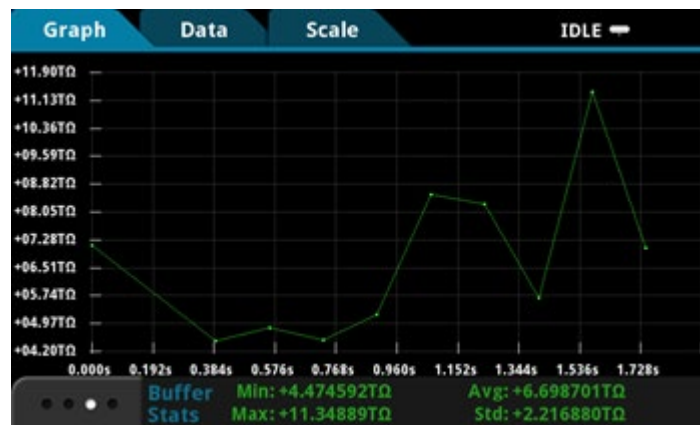

Set up the application using SCPI commands

The following SCPI commands make insulation resistance measurements by sourcing 700 V and measuring the resistance. The Simple Loop trigger model template is used to make 10 measurements at 100 ms intervals.

Send the following commands for this example application:

Command	Description
<pre>*RST :ROUT:TERM REAR :SOUR:FUNC VOLT :SOUR:VOLT 700 :SOUR:VOLT:ILIM 0.01 :SENS:FUNC "CURR" :SENS:CURR:RANG:AUTO ON :SENSE:CURR:UNIT OHM :TRIG:LOAD "SimpleLoop", 10, 0.1 :OUTP ON :INIT *WAI :TRAC:DATA? 1, 10, "defbuffer1", READ, REL :OUTP OFF</pre>	<ul style="list-style-type: none"> ■ Reset the 2470. ■ Select the rear-panel terminals for the measurement. ■ Set to source voltage. ■ Output 700 V. ■ Set a 10 mA source limit. ■ Set the instrument to measure current. ■ Set the current range to autorange. ■ Set the instrument to measure resistance. ■ Use the Simple Loop trigger model to make 10 measurements at 100 ms intervals. ■ Turn the output on. ■ Initiate readings. ■ Wait for the measurement to finish. ■ Read the resistance and time values from <code>defbuffer1</code>. ■ Turn the output off.

Set up the application using TSP commands

The following TSP code is designed to be run from Keithley Instruments Test Script Builder (TSB). TSB is a software tool that is available from tek.com/keithley. You can install and use TSB to write code and develop scripts for TSP-enabled instruments. Information about how to use TSB is in the online help for TSB and in the “Introduction to TSP operation” section of the *Model 2470 Reference Manual*.

By default, the 2470 uses the SCPI command set. You must select the TSP command set before sending TSP commands to the instrument.

To enable TSP commands:

1. Press the **MENU** key.
2. Under System, select **Settings**.
3. Set the Command Set to **TSP**.
4. At the prompt to reboot, select **Yes**.

The following TSP commands make insulation resistance measurements by sourcing 700 V and measuring the resistance. The Simple Loop trigger model template is used to make 10 measurements at 100 ms intervals. After the code is executed, the measurement results are displayed in the Instrument Console of Test Script Builder.

Send the following commands for this example application:

```
--Reset the instrument
reset()
--Set up the source function.
smu.source.func = smu.FUNC_DC_VOLTAGE
smu.source.ilimit.level = 1e-3
smu.source.level = 700
--Set up the measure function
smu.measure.func = smu.FUNC_DC_CURRENT
smu.measure.unit = smu.UNIT_OHM
smu.terminals = smu.TERMINALS_REAR
smu.measure.autorange = smu.ON
smu.measure.nplc = 1
-- Turn on the source output and make readings.
trigger.model.load("SimpleLoop", 10, 0.1)
smu.source.output = smu.ON
trigger.model.initiate()
-- Wait for the measurements to complete.
waitcomplete()
-- Parse index and the data into three columns.
print("Rdg #,", "Time (s)", "Resistance (Ohm)")
for i = 1, defbuffer1.n do
    print(i, defbuffer1.relativetimestamps[i], defbuffer1[i])
end
--Turn off the output.
smu.source.output = smu.OFF
```

The graph in the following figure demonstrates what the plotted results might look like.

Figure 27: Insulation resistance test results

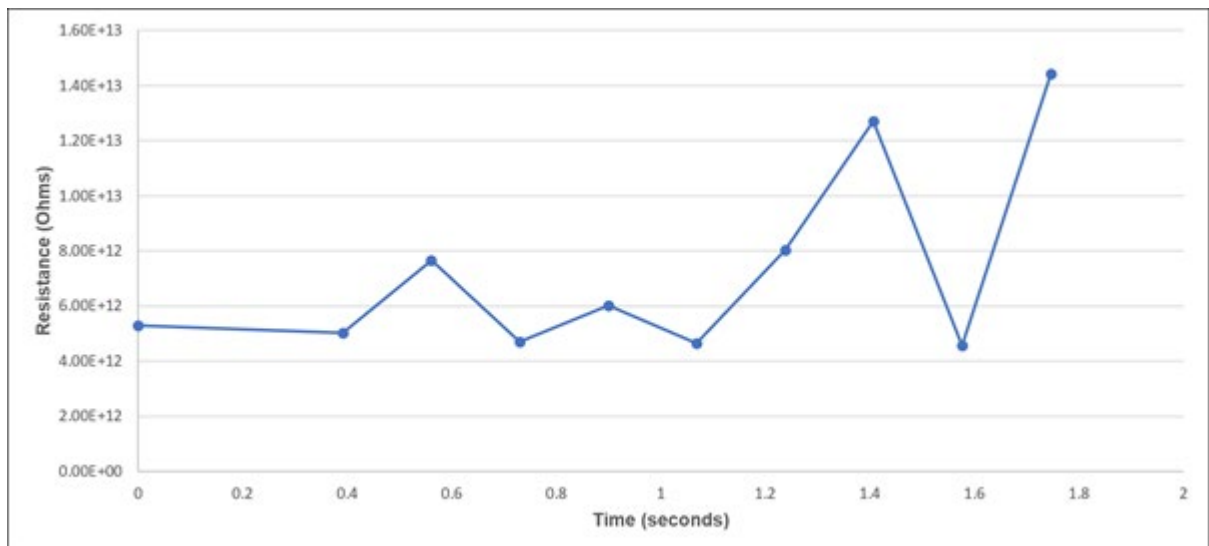

Measure I-V characteristics of FETs

In this section:

Introduction	6-1
Equipment required.....	6-2
Set up remote communications.....	6-2
Set up external hardware triggers	6-3
Device connections.....	6-5
Remote control of FET testing using SCPI commands	6-8
Remote control of FET testing using TSP commands.....	6-13

Introduction

This example application uses one or two 2470 instruments to perform I-V characterization of field-effect transistors (FETs). The high-voltage capabilities and extremely sensitive current measurement ranges of the 2470 make it especially suited to wide band-gap semiconductor devices. The FET for these examples could be a traditional silicon-based MOSFET or gallium nitride (GaN) or silicon carbide (SiC) based.

This application consists of examples that demonstrate:

- How to use a 2470 to perform a drain leakage current measurement on a FET
- How to use two 2470s to find the subthreshold swing of a FET
- How to use two 2470s to perform a drain family of curves (V_{DS} - I_D) on a three-terminal FET

Determining the I-V parameters of FETs helps you ensure that they function properly in their intended applications and that they meet specifications. There are many I-V tests that you can perform with the 2470, including drain or gate leakage, breakdown voltage, threshold voltage, subthreshold swing, and drain current. The number of 2470 instruments required for testing depends on the number of FET terminals that must be biased, swept, and measured.

NOTE

The SCPI and TSP examples differ in this application. The TSP version uses Keithley Instruments TSP-Link®, which is a high-speed trigger synchronization and communication bus that test system builders can use to connect multiple instruments in a master and subordinate configuration. Once connected, all the instruments that are equipped with TSP-Link in a system can be programmed and operated under the control of the master instrument or instruments. This allows the instruments to run tests more quickly because they can be decoupled from frequent computer interaction. TSP-Link is not available when the SCPI command set is selected.

Equipment required

- Two 2470 High Voltage SourceMeter Instruments
- Four TRX-1100V-X 3-Slot High-Voltage Low-Noise Triaxial Cables (available from Keithley Instruments)
- A metal-shielded test fixture or probe station with female triaxial connectors
- One high power or wide band-gap three-terminal FET
- One ethernet, GPIB, or USB cable for the TSP remote command examples
- One cross-over ethernet cable for TSP-Link connections between the two 2470s (one is included with each 2470)

Set up remote communications

This application is configured to run remotely. You can run this application from any of the supported communication interfaces for the instrument (GPIB, USB, or ethernet).

The following figure shows the rear-panel connection locations for the remote communication interfaces.

Figure 28: Model 2470 remote interface connections

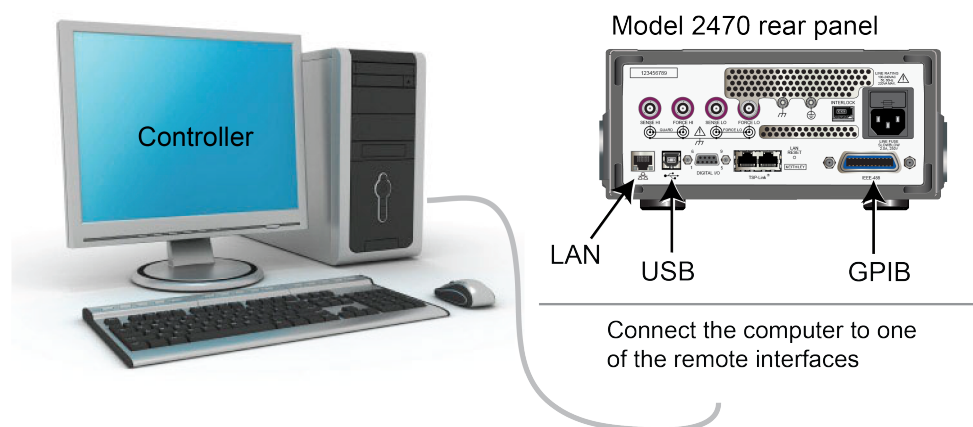

Set up external hardware triggers

To enable synchronization between the two 2470 instruments for stepping and sweeping voltages, connect the external triggers of each instrument to the other. The cabling you use depends on which 2470 programming command set you choose to control the test.

Connections for the SCPI command set

If you are using the SCPI command set, connect a DB-9 male-to-male cable between the digital I/O connectors on the back of each of the instruments, as shown in the figure below.

For more detailed information about the digital I/O connector pins, see "Digital I/O" in the *2470 Reference Manual*.

Figure 29: GPIB and DB-9 connections for the SCPI programming example

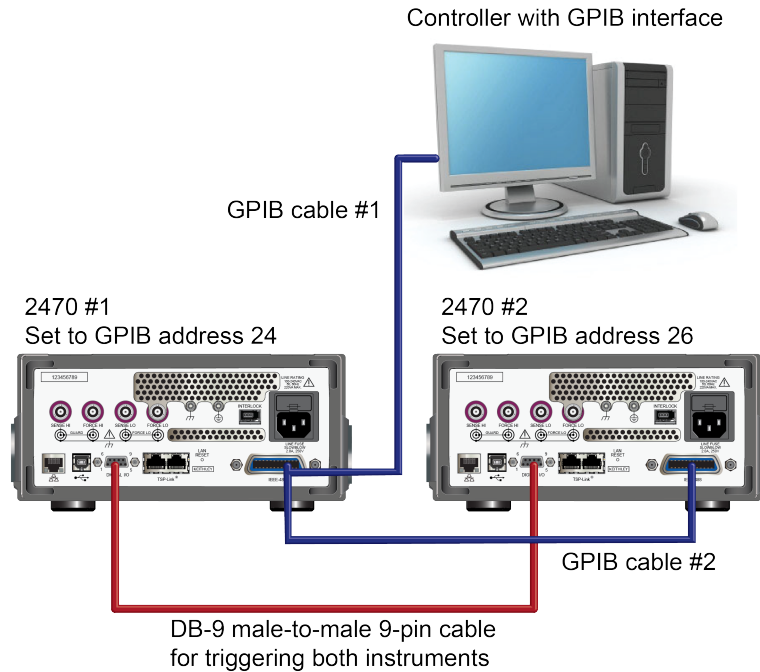

The figure above also shows the communication cable connections if you are using the GPIB remote communication interface. GPIB cable #1 connects the GPIB port on the computer (controller) to the IEEE-488 connector on the rear panel of 2470 #1. GPIB cable #2 connects the IEEE-488 connectors of the two 2470s.

NOTE

Each 2470 must have a different GPIB address. You can set this up using the front panel. For details, see [Set the GPIB address](#) (on page 3-4).

If you are using USB cables to connect the computer and 2470 instruments, each instrument must be connected to the computer with a separate USB cable.

If you are using ethernet connections to connect the computer and 2470 instruments, the instruments and computer must be connected using an ethernet switch or hub.

Connections for the TSP command set

If you use the Test Script Processor (TSP®) command set for remote programming, use a RJ-45 LAN crossover cable to connect the TSP-Link ports on the rear panels of the 2470 instruments (see figure below). For more information about using TSP-Link, see "TSP-Link System Expansion Interface" in the *2470 Reference Manual*.

Figure 30: TSP-Link connections

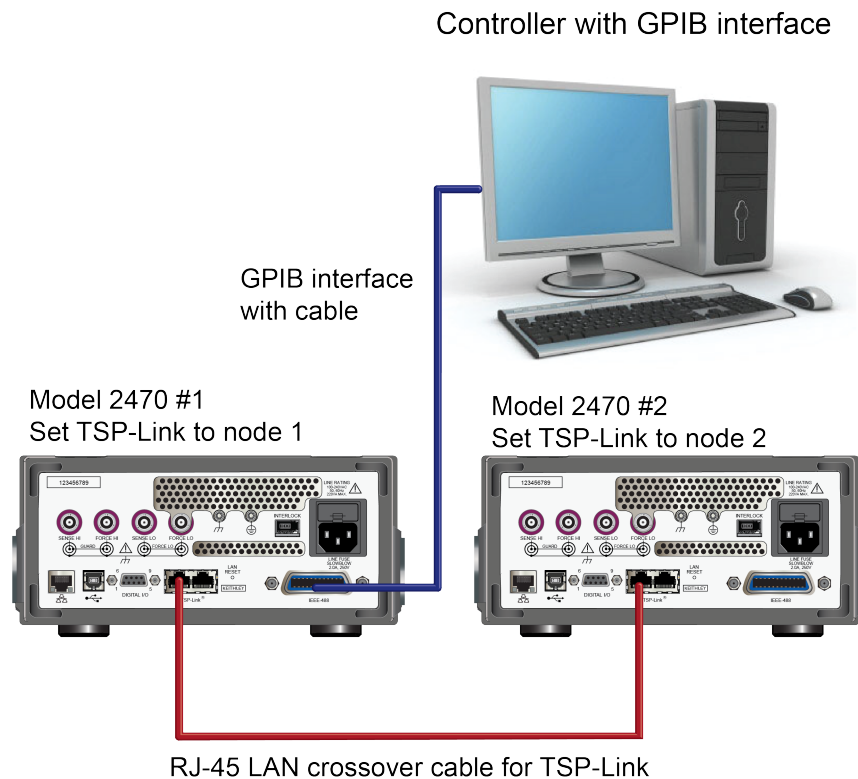

For GPIB communication from the computer to the 2470 instruments, you only need one cable from the GPIB interface to one of the 2470 IEEE-488 interfaces (2470 #1 in the figure above).

Set the TSP-Link node of 2470 #1 to node 1 and the TSP-Link node of 2470 #2 to node 2.

To set the 2470 TSP-Link nodes from the front panel:

1. Press the **MENU** key.
2. Under System, select **Communication**. The SYSTEM COMMUNICATION window opens.
3. On the **TSP-Link** tab, set **Node** to the node number of this instrument and select **OK**.
4. Select **Initialize**.
5. Press the **HOME** key to return to the Home screen.

Repeat these steps for each 2470 instrument in your TSP-Link network.

Device connections

Device connections vary depending on the test you will perform. Since these applications typically involve measuring very low currents, it is recommended that you use the triaxial connections on the rear-panel of the 2470 with low-noise triaxial cables. Triaxial cables provide the lowest noise possible when measuring low currents.

Drain leakage current measurement device connections

A drain leakage current measurement on a FET requires only one 2470. For this measurement, the gate-source potential must be 0 V, so the gate and source connection pins are shorted together. The SMU is connected between the drain and source to apply a bias voltage.

To change this measurement to a gate leakage current measurement, you can short the drain and source together and connect the 2470 between the gate and source to apply a bias voltage.

The following figure shows the setup for a drain leakage current measurement.

Figure 31: Drain leakage current measurement device connections

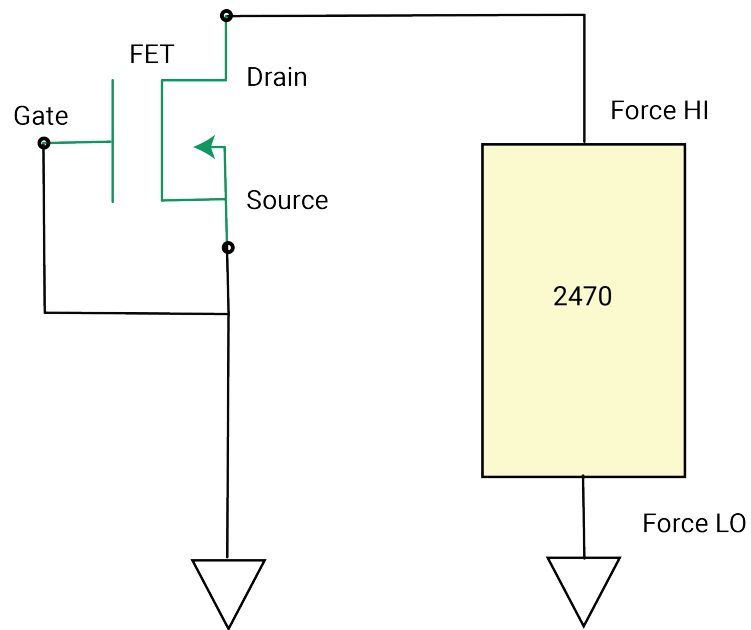

The following figure shows the connections from the rear-panel terminals of the 2470.

Figure 32: Drain leakage current measurement rear-panel terminal connections

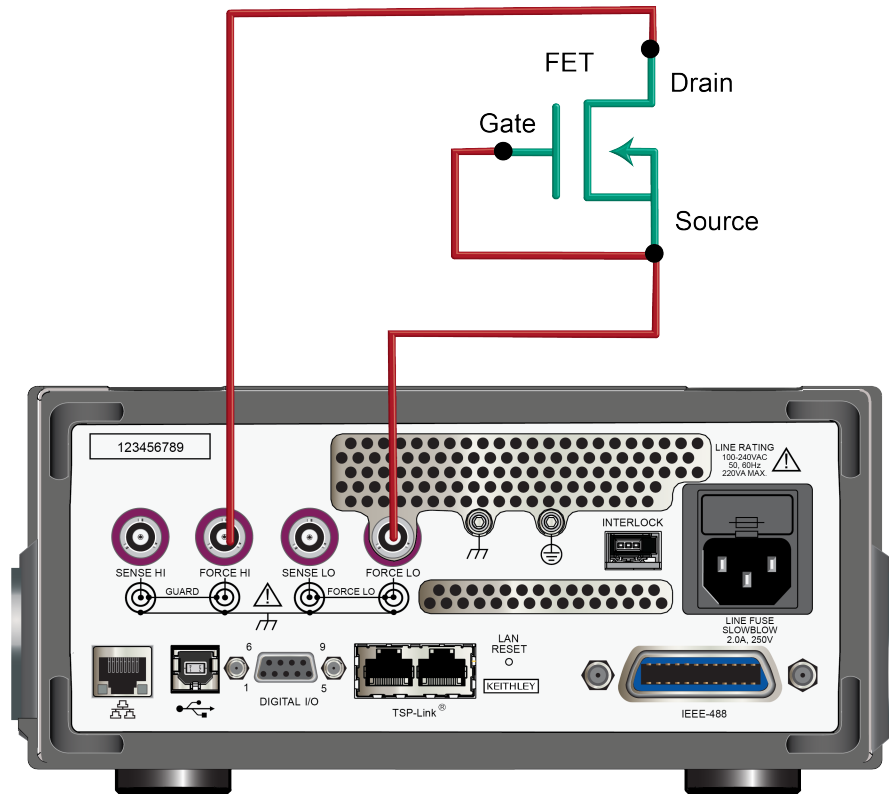

Subthreshold current or drain family of curves measurement device connections

Both a subthreshold current and a drain family of curves measurement use the same instrument connections. Both 2470s are configured to source voltage and measure current.

In this circuit:

- Connect the Force HI terminal of 2470 #1 to the gate of the FET.
- Connect the Force HI terminal of 2470 #2 to the drain of the FET.
- Connect the source of the FET to the Force LO terminals of both 2470s.

To source and measure from all three terminals of the FET, you need a third 2470.

The following figure shows an I-V test configuration for a FET using two 2470s.

Figure 33: Three-terminal I-V test configuration for a FET

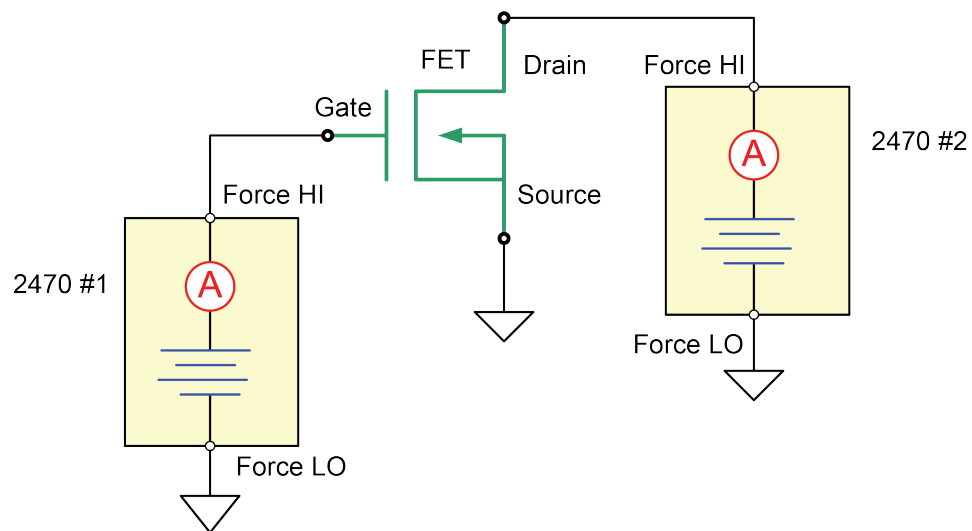

The following figure shows the connections from the rear-panel terminals of both 2470s to the FET.

Figure 34: Two 2470s set up to test a three-terminal FET

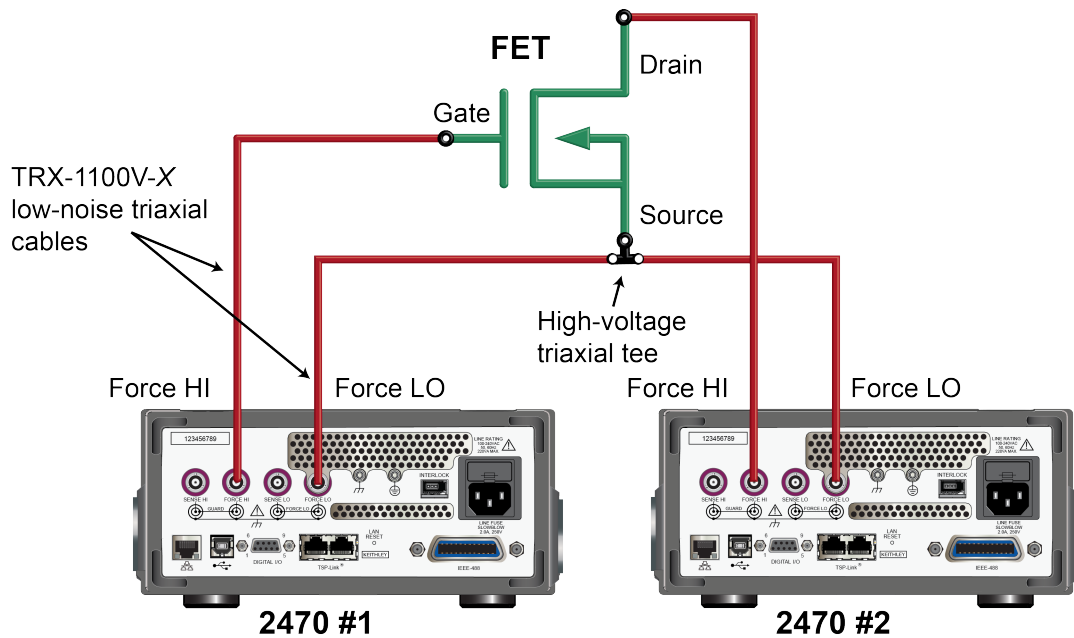

Remote control of FET testing using SCPI commands

The two example sequences of SCPI commands for this application generate a drain family of curves on a FET using two 2470 instruments. One of the examples uses the trigger model to generate the family of curves. The other example uses a linear sweep. You may need to make modifications for operation in your programming environment.

Set up the application using SCPI commands with the trigger model

In this application, the gate voltage steps from 2 V to 5 V in 1 V steps, the drain voltage sweeps from 0 V to 5 V in 51 steps, and the drain current is measured. The current and voltage measurements are stored in `defbuffer1`. The 2470 trigger model synchronizes the two 2470 instruments.

You send commands to either the sweeper on the drain (SMU 1) or the stepper on the gate (SMU 2). In the table, commands for the sweeper have a light gray background. Commands for the stepper have a darker gray background. The light-brown shaded code represents pseudocode that will vary depending on the programming environment you use. Each bulleted item in the Description column describes a single line of code in the Commands column.

Send the following commands for this example application:

SMU 1, SMU 2, or pseudocode	Commands	Description
SMU 1	<pre>*RST :SENS:FUNC "CURR" :SENS:CURR:RANG:AUTO ON :ROUT:TERM REAR :SOUR:FUNC VOLT :SOUR:VOLT:RANG 20 :SOUR:CONF:LIST:CRE "stepVals" :DIG:LINE1:MODE TRIG, OUT :DIG:LINE2:MODE TRIG, IN :TRIG:DIG1:OUT:STIM NOT1 :TRIG:DIG2:IN:CLE :TRIG:DIG2:IN:EDGE RIS</pre>	<ul style="list-style-type: none"> ■ Reset the instrument. ■ Set to measure current. ■ Set to measure with autorange enabled. ■ Set to rear terminals. ■ Set to source voltage. ■ Set to 20 V source range. ■ Create a source configuration list called <code>stepVals</code>. ■ Set digital line 1 to trigger out. ■ Set digital line 2 to trigger in. ■ Set the stimulus for digital line 1 to the <code>notify1</code> event. ■ Clear digital line 2. ■ Set to detect rising edge on line 2.
Pseudocode	<code>for i = 2 to 5 do:</code>	<ul style="list-style-type: none"> ■ Set up a <code>for</code> loop from 2 to 5.
SMU 1	<pre>:SOUR:VOLT i :SOUR:CONF:LIST:STORE "stepVals"</pre>	<ul style="list-style-type: none"> ■ Set the voltage level to the iteration number. ■ Store the source configuration to <code>stepVals</code>.
Pseudocode	<code>end for</code>	<ul style="list-style-type: none"> ■ End the <code>for</code> loop.
SMU 1	<pre>:TRIG:BLOC:CONF:RECALL 1, "stepVals" :TRIG:BLOC:SOUR:STAT 2, ON :TRIG:BLOC:MEAS 3 :TRIG:BLOC:NOT 4, 1 :TRIG:BLOC:WAIT 5, DIG2 :TRIG:BLOC:CONF:NEXT 6, "stepVals" :TRIG:BLOC:BRAN:COUN 7, 4, 3 :TRIG:BLOC:SOUR:STAT 8, OFF</pre>	<ul style="list-style-type: none"> ■ Create trigger model block 1 to load <code>stepVals</code> at the first index. ■ Create block 2 to turn the output on. ■ Create block 3 to make a measurement. ■ Create block 4 to generate the <code>notify1</code> event. ■ Create block 5 to wait on digital line 2. ■ Create block 6 to load the next index of <code>stepVals</code>. ■ Create block 7 to branch to block 3, 3 times. ■ Create block 8 to turn the output off.

SMU 2	<pre>*RST :SENS:FUNC "CURR" :SENS:CURR:RANG:AUTO ON :ROUT:TERM REAR :SOUR:FUNC VOLT :SOUR:VOLT:RANG 20 :SOUR:VOLT:ILIM 1 :SOUR:CONF:LIST:CRE "sweepVals" :DIG:LINE2:MODE TRIG, OUT :DIG:LINE1:MODE TRIG, IN :TRIG:DIG2:OUT:STIM NOT2 :TRIG:DIG1:IN:CLE :TRIG:DIG1:IN:EDGE RIS</pre>	<ul style="list-style-type: none"> ▪ Reset the instrument. ▪ Set to measure current. ▪ Set to measure with autorange enabled. ▪ Set to rear terminals. ▪ Set to source voltage. ▪ Set to 20 V source range. ▪ Set the source limit to 1 A. ▪ Create the source configuration list <code>sweepVals</code>. ▪ Set digital line 2 to trigger out. ▪ Set digital line 1 to trigger in. ▪ Set the stimulus for digital line 2 to the <code>notify2</code> event. ▪ Clear digital line 1. ▪ Detect for a rising edge on line 1.
Pseudocode	<pre>for i = 0, 5, 0.1 do:</pre>	<ul style="list-style-type: none"> ▪ Set up a <code>for</code> loop from 0 to 5 in 0.1 steps (inclusive).
SMU 2	<pre>:SOUR:VOLT i :SOUR:CONF:LIST:STORE "sweepVals"</pre>	<ul style="list-style-type: none"> ▪ Set the voltage level to the iteration number. ▪ Store the source configuration to <code>sweepVals</code>.
Pseudocode	<pre>end for</pre>	<ul style="list-style-type: none"> ▪ End the <code>for</code> loop.
SMU 2	<pre>:TRIG:BLOC:CONF:RECALL 1, "sweepVals" :TRIG:BLOC:SOUR:STAT 2, ON :TRIG:BLOC:WAIT 3, DIG1 :TRIG:BLOC:DEL:CONS 4, 0.01 :TRIG:BLOC:MEAS 5 :TRIG:BLOC:CONF:NEXT 6, "sweepVals" :TRIG:BLOC:BRAN:COUN 7, 51, 4 :TRIG:BLOC:NOT 8, 2 :TRIG:BLOC:BRAN:COUN 9, 4, 3 :TRIG:BLOC:SOUR:STAT 10, OFF</pre>	<ul style="list-style-type: none"> ▪ Create a block to load <code>sweepVals</code> at the first index. ▪ Create a block to turn the output on. ▪ Create a block to wait on digital line 3. ▪ Create a block to delay for 0.01 seconds. ▪ Create a block to take a measurement. ▪ Create a block to load the next index of <code>sweepVals</code>. ▪ Create a block to branch to block 4, 50 times. ▪ Create a block to generate the <code>notify2</code> event. ▪ Create a block to branch to block 3 three times. ▪ Create a block to turn the output off.
SMU 1	<pre>:INIT *WAI</pre>	<ul style="list-style-type: none"> ▪ Initiate the trigger model. ▪ Wait for the model to complete.

SMU 2	<code>:INIT *WAI</code>	<ul style="list-style-type: none"> Initiate the trigger model. Wait for the model to complete.
Pseudocode	<code>vds = [] ids = [] for i = 2, 5 do:</code>	<ul style="list-style-type: none"> Create an empty array to hold measured voltage values. Create an empty array to hold measured current values. Set up a <code>for</code> loop from 2 to 5 (including 5).
Pseudocode for SMU2	<code>vds[i-1] = TRAC:DATA? 1 + 51*(i-2), 51*(i-1), "defbuffer1", SOUR ids[i-1] = TRAC:DATA? 1 + 51*(i-2), 51*(i-1), "defbuffer1", READ</code>	<ul style="list-style-type: none"> Save the sourced and measured values to the arrays <code>vds</code> and <code>ids</code>, respectively. The readings from each step are saved at each index in the array.
Pseudocode	<code>end for</code>	<ul style="list-style-type: none"> End the <code>for</code> loop.

Set up the application using SCPI commands in a linear sweep

In this example, the gate voltage steps from 2 V to 6 V in 1 V steps, the drain voltage sweeps from 0 V to 5 V in 51 steps, and the drain current is measured. The application retrieves each of 51 readings and source values from `defbuffer1` and saves them in the arrays `vds` and `ids`, respectively.

You send commands to either the sweeper (SMU 2) or the stepper (SMU 1). In the table, the commands for the sweeper are shown with a light gray background. The commands for the stepper are shown with a darker gray background. The light-brown shaded code represents pseudocode that will vary depending on the programming environment you use. Each bulleted item in the Description column describes a single line of code in the Commands column.

Send the following commands for this application:

SMU 1, SMU 2, or pseudocode	Commands	Description
SMU 1	<code>*RST :SENS:FUNC "CURR" :SENS:CURR:RANG:AUTO ON :ROUT:TERM REAR :SOUR:FUNC VOLT :SOUR:VOLT:RANG 20</code>	<ul style="list-style-type: none"> Reset the instrument. Set to measure current. Set to measure with autorange enabled. Set to use rear terminals. Set to source voltage. Set to 20 V source range.

SMU 2	<pre>*RST :SENS:FUNC "CURR" :SENS:CURR:RANG:AUTO ON :ROUT:TERM REAR :SOUR:FUNC VOLT :SOUR:VOLT:RANG 20 :SOUR:VOLT:ILIM 1 :SOUR:SWE:VOLT:LIN 0, 5, 51, 0.01</pre>	<ul style="list-style-type: none"> Reset the instrument. Set to measure current. Set to measure with autorange enabled. Set to use the rear terminals. Set to source voltage. Set to the 20 V source range. Set the source limit to 1 A. Set up a linear sweep from 0 V to 5 V in 51 steps, with a delay of 10 ms.
SMU 1	:OUTP ON	<ul style="list-style-type: none"> Turn on the output.
Pseudocode	<pre>vds = [] ids = [] for i = 2, 5 do:</pre>	<ul style="list-style-type: none"> Create an empty array to hold measured voltage values. Create an empty array to hold measured current values. Set up a <code>for</code> loop from 2 to 5 (inclusive).
SMU 1	:SOUR:VOLT i	<ul style="list-style-type: none"> Set the source level to the iteration number of the loop.
Pseudocode	delay(0.5)	<ul style="list-style-type: none"> Delay for 500 ms to allow for settling.
SMU 2	:INIT *WAI	<ul style="list-style-type: none"> Trigger the sweep to start. Wait for the operations to complete.
Pseudocode	Read output queue	<ul style="list-style-type: none"> Wait for sweep to complete.
Pseudocode for SMU 2	<pre>vds[i-1]=TRAC:DATA? 1, 51, "defbuffer1", SOUR ids[i-1]=TRAC:DATA? 1, 51, "defbuffer1", READ</pre>	<ul style="list-style-type: none"> Receive each of 51 readings and source values from the buffer and save them in the arrays <code>vds</code> and <code>ids</code>, respectively. The arrays start at index one. Each point in the arrays contains a list of values for each gate voltage.
Pseudocode	end for	<ul style="list-style-type: none"> End the <code>for</code> loop.
SMU 2	:OUTP OFF	<ul style="list-style-type: none"> Turn the output off. NOTE: All of the source and measure values can be returned from the arrays <code>vds</code> and <code>ids</code>.

Remote control of FET testing using TSP commands

The following TSP code is designed to be run from Keithley Instruments Test Script Builder (TSB). TSB is a software tool that is available from tek.com/keithley. You can install and use TSB to write code and develop scripts for TSP-enabled instruments. Information about how to use TSB is in the online help for TSB and in the “Introduction to TSP operation” section of the *Model 2470 Reference Manual*.

By default, the 2470 uses the SCPI command set. You must select the TSP command set before sending TSP commands to the instrument.

To enable TSP commands:

1. Press the **MENU** key.
2. Under System, select **Settings**.
3. Set the Command Set to **TSP**.
4. At the prompt to reboot, select **Yes**.

Set up the drain leakage current measurement using TSP commands

The following TSP code performs a drain leakage measurement on a FET by sourcing 600 V and measuring the resulting leakage current. The DurationLoop trigger model template applies the voltage for 60 s and makes measurements at 200 ms intervals.

After the code is executed, the measurement results are displayed in the Instrument Console of Test Script Builder. From the Instrument Console, you can copy the data into a spreadsheet for graphing.

Send the following commands for this example application:

```

-- Reset the instrument, which also clears the buffer.
reset()
-- Set up the source function.
smu.source.func = smu.FUNC_DC_VOLTAGE
smu.source.ilimit.level = 10e-3
smu.source.level = 600
-- Set up measure function.
smu.measure.func = smu.FUNC_DC_CURRENT
smu.measure.terminals = smu.TERMINALS_REAR
smu.measure.autorange = smu.ON
smu.measure.nplc = 1
-- Turn on the output and initiate readings.
trigger.model.load("DurationLoop", 60, 0.2)
trigger.model.initiate()
-- Wait for the trigger model to complete.
waitcomplete()
smu.source.output = smu.OFF
-- Parse index and data into three columns.
print("Rdg #,", "Time (s)", "Current (A),")
for i = 1, defbuffer1.n do
    print(string.format("%i, %.5f, %.6e", i, defbuffer1.relativetimestamps[i],
        defbuffer1[i]))
end

```

The graph in the following figure demonstrates what the plotted drain leakage current might look like.

Figure 35: Drain leakage current graph

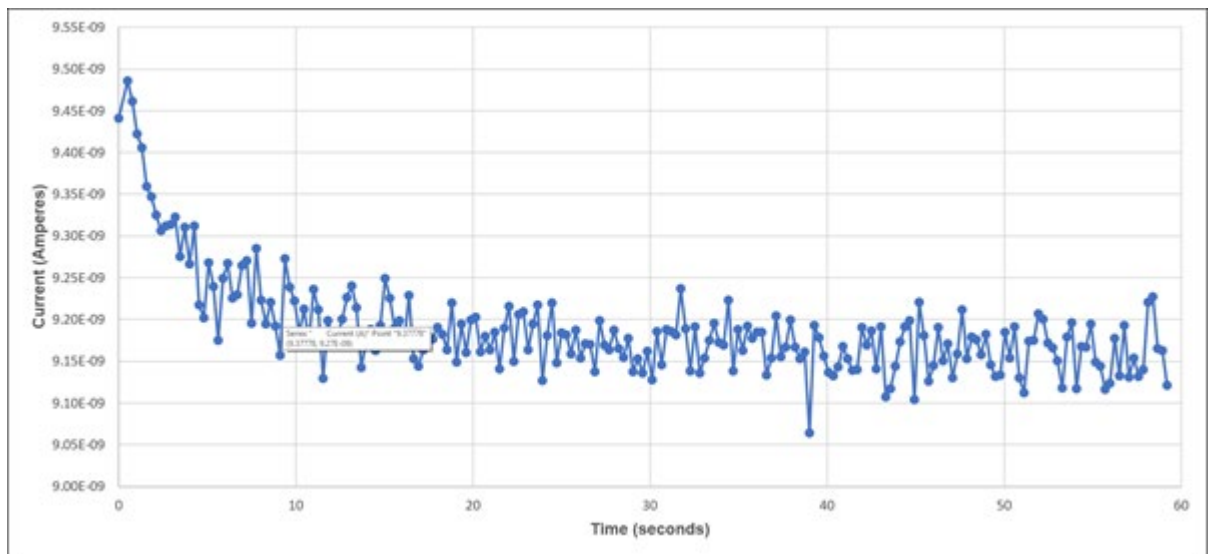

Set up a subthreshold current measurement using TSP commands

The following TSP code uses the trigger model to find the subthreshold swing, S , of a FET using two 2470s communicating with each other using TSP-Link. The SMU at Node 1 is connected to the gate and steps voltage from 0 V to 5 V. The SMU at Node 2 is connected to the drain and applies a bias voltage while measuring current.

After the measurement is complete, a simple numerical exponential fit is found and the subthreshold swing, S , is taken as the inverse of the exponential slope. The result and measurement data is displayed in the Instrument Console of Test Script Builder. From the Instrument Console, you can copy the data into a spreadsheet for graphing.

Send the following commands for this example application:

```
--##### Settings and TSP-Link setup #####
local gateVstart = 0
local gateVstop = 5
local gateStepSize = 0.1
local gateIlimit = 0.1

local drainV = 10
local drainIlimit = 0.1
-- Fit settings - The slope is calculated between these gateV points.
-- fitHighV should be less than or equal to the threshold voltage.
local fitLowV = 2
local fitHighV = 3.5

-- Reset the instruments and the TSP-Link connection and clear the buffers.
tsplink.initialize()
reset()
-- If the tsplink state is not online, print an error message and quit.
state = tsplink.state
if state ~= "online" then
    print("Error:\n-Check that all SMUs have a different node number")
    print("-Check that all SMUs are connected correctly\n")
    return
end
-- Set up TSP-Link node shortcuts.
local gate = node[1]
local drain = node[2]

--##### 2470 SMU #1 (gate) setup #####
-- Set up the source function.
gate.smu.source.configlist.create("stepVals")
gate.smu.source.func = gate.smu.FUNC_DC_VOLTAGE
gate.smu.source.autorange = gate.smu.ON
gate.smu.source.ilimit.level = gateIlimit
-- Set up the measure function.
gate.smu.measure.func = gate.smu.FUNC_DC_CURRENT
gate.smu.measure.autorange = gate.smu.ON
gate.smu.measure.terminals = gate.smu.TERMINALS_REAR
```

```

-- Set up TSP-Link triggering.
gate.tsplink.line[1].reset()
gate.tsplink.line[1].mode = gate.tsplink.MODE_SYNCHRONOUS_MASTER
gate.trigger.tsplinkout[1].stimulus = gate.trigger.EVENT_NOTIFY1
-- Populate the stepVals source config list with source levels gateVstart volts to
gateVstop volts.
for i = gateVstart, gateVstop, gateStepSize do
    gate.smu.source.level = i
    gate.smu.source.configlist.store("stepVals")
end
local stepPoints = (gateVstop - gateVstart) * (1 / gateStepSize) + 1
-- Set up the trigger model.
gate.trigger.model.setblock(1, gate.trigger.BLOCK_CONFIG_RECALL, "stepVals")
gate.trigger.model.setblock(2, gate.trigger.BLOCK_SOURCE_OUTPUT, gate.smu.ON)
gate.trigger.model.setblock(3, gate.trigger.BLOCK_MEASURE)
gate.trigger.model.setblock(4, gate.trigger.BLOCK_NOTIFY,
    gate.trigger.EVENT_NOTIFY1)
gate.trigger.model.setblock(5, gate.trigger.BLOCK_WAIT, gate.trigger.EVENT_TSPLINK1)
gate.trigger.model.setblock(6, gate.trigger.BLOCK_CONFIG_NEXT, "stepVals")
gate.trigger.model.setblock(7, gate.trigger.BLOCK_BRANCH_COUNTER, stepPoints, 3)
gate.trigger.model.setblock(8, gate.trigger.BLOCK_SOURCE_OUTPUT, gate.smu.OFF)

--##### 2470 SMU #2 (drain) setup #####
-- Set up the source function.
drain.smu.source.func = drain.smu.FUNC_DC_VOLTAGE
drain.smu.source.ilimit.level = drainIlimit
drain.smu.source.level = drainV
-- Set up measure function.
drain.smu.measure.func = drain.smu.FUNC_DC_CURRENT
drain.smu.measure.terminals = drain.smu.TERMINALS_REAR
drain.smu.measure.autorange = drain.smu.ON
-- Set up TSP-Link triggering.
drain.tsplink.line[1].mode = drain.tsplink.MODE_SYNCHRONOUS_ACCEPTOR
drain.trigger.tsplinkout[1].stimulus = drain.trigger.EVENT_NOTIFY1
-- Set up the trigger model.
drain.trigger.model.setblock(1, drain.trigger.BLOCK_SOURCE_OUTPUT, drain.smu.ON)
drain.trigger.model.setblock(2, drain.trigger.BLOCK_WAIT,
    drain.trigger.EVENT_TSPLINK1)
drain.trigger.model.setblock(3, drain.trigger.BLOCK_DELAY_CONSTANT, 0.01)
drain.trigger.model.setblock(4, drain.trigger.BLOCK_MEASURE)
drain.trigger.model.setblock(5, drain.trigger.BLOCK_NOTIFY,
    drain.trigger.EVENT_NOTIFY1)
drain.trigger.model.setblock(6, drain.trigger.BLOCK_BRANCH_COUNTER, stepPoints, 2)
drain.trigger.model.setblock(7, drain.trigger.BLOCK_SOURCE_OUTPUT, drain.smu.OFF)

--##### Start test #####
-- Start the trigger model for both SMUs and wait until it is complete.
gate.trigger.model.initiate()
drain.trigger.model.initiate()
print("Test Running...")
waitcomplete()
if drain.defbuffer1.n == 0 or gate.defbuffer1.n == 0 then
    print("\nNo readings in buffer\n")
    return
end
end

```

```

-- Perform basic exponential fit
local diffHighV, diffLowV = 9.9e37, 9.9e37
local fitHighIndex = 0
local fitLowIndex = 0
local gateV = 0
local gateHighV = 0
local gateLowV = 0
-- Find actual gate voltage (and indexes) closest to fitHighV and fitLowV
for i = 1, gate.defbuffer1.n do
    gateV = gate.defbuffer1.sourcevalues[i]
    if math.abs(gateV - fitHighV) < diffHighV then
        diffHighV = math.abs(gateV - fitHighV)
        gateHighV = gateV
        fitHighIndex = i
    end
    if math.abs(gateV - fitLowV) < diffLowV then
        diffLowV = math.abs(gateV - fitLowV)
        gateLowV = gateV
        fitLowIndex = i
    end
end
-- Find drain current and natural log of current at the two fit voltages
local drainHighI = drain.defbuffer1.readings[fitHighIndex]
local drainLowI = drain.defbuffer1.readings[fitLowIndex]
local ln_drainHighI = math.log(drainHighI)
local ln_drainLowI = math.log(drainLowI)
-- Find subthreshold swing, S, inverse of subthreshold slope, multiply by 1000 for mV/dec
local diffgateV = gateHighV - gateLowV
local diff_ln_drainI = ln_drainHighI - ln_drainLowI
local S = (diffgateV / diff_ln_drainI) * 1000

-- Print the results
print(string.format("Subthreshold Swing = %.4f mV/decade", S))
print(string.format("High current in fit = %.6E amps, low current in fit = %.6E amps",
    drainHighI, drainLowI))
print("Index, ".."\t".. "gateV (V), ".."\t".. "drainI (A)")
for k = 1, stepPoints do
    print(
        string.format("%d, \t%.5f, \t%.6E",
            k, gate.defbuffer1.sourcevalues[k], drain.defbuffer1.readings[k]
        )
    )
end

```

Set up the drain family of curves measurement using TSP commands

The following TSP code uses the trigger model to generate a drain family of curves on a FET using two 2470s communicating with each other using TSP-Link. The SMU at Node 1 is connected to the gate and steps voltage from 2 V to 5 V in four steps. The SMU at Node 2 is connected to the drain and sweeps voltage from 0 V to 5 V with 51 points at each step.

After the code is executed, the measurement results are displayed in the Instrument Console of Test Script Builder. From the Instrument Console, you can copy the data into a spreadsheet for graphing.

Send the following commands for this example application:

```
--##### Settings and TSP-Link setup #####
local gateVstart = 2
local gateVstop = 5
local gateStepSize = 1
local gateIlimit = 1e-3

local drainVstart = 0
local drainVstop = 5
local drainStepSize = 0.1
local drainIlimit = 1e-3

-- Reset the instruments and the TSP-Link connection and clear the buffers.
tsplink.initialize()
reset()
-- If the tsplink state is not online, print an error message and quit.
state = tsplink.state
if state ~= "online" then
    print("Error:\n-Check that all SMUs have a different node number")
    print("-Check that all SMUs are connected correctly\n")
    return
end
-- Set up the TSP-Link node shortcuts.
local gate = node[1]
local drain = node[2]

--##### Model 2470 #1 (gate) setup #####
-- Set up the source function.
gate.smu.source.configlist.create("stepVals")
gate.smu.source.func = gate.smu.FUNC_DC_VOLTAGE
gate.smu.source.autorange = gate.smu.ON
gate.smu.source.ilimit.level = gateIlimit
-- Set up the measure function.
gate.smu.measure.func = gate.smu.FUNC_DC_CURRENT
gate.smu.measure.autorange = gate.smu.ON
gate.smu.measure.terminals = gate.smu.TERMINALS_REAR
-- Set up TSP-Link triggering.
tsplink.line[1].reset()
gate.tsplink.line[1].mode = gate.tsplink.MODE_SYNCHRONOUS_MASTER
gate.trigger.tsplinkout[1].stimulus = gate.trigger.EVENT_NOTIFY1
```



```

-- Populate the stepVals source config list, with source levels 2 V to 5 V.
for i = gateVstart, gateVstop, gateStepSize do
    gate.smu.source.level = i
    gate.smu.source.configlist.store("stepVals")
end
local stepPoints = (gateVstop - gateVstart) * (1 / gateStepSize) + 1
-- Set up the trigger model.
gate.trigger.model.setblock(1, trigger.BLOCK_CONFIG_RECALL, "stepVals")
gate.trigger.model.setblock(2, trigger.BLOCK_SOURCE_OUTPUT, gate.smu.ON)
gate.trigger.model.setblock(3, trigger.BLOCK_MEASURE)
gate.trigger.model.setblock(4, trigger.BLOCK_NOTIFY, gate.trigger.EVENT_NOTIFY1)
gate.trigger.model.setblock(5, trigger.BLOCK_WAIT, gate.trigger.EVENT_TSPLINK1)
gate.trigger.model.setblock(6, trigger.BLOCK_CONFIG_NEXT, "stepVals")
gate.trigger.model.setblock(7, trigger.BLOCK_BRANCH_COUNTER, stepPoints, 3)
gate.trigger.model.setblock(8, trigger.BLOCK_SOURCE_OUTPUT, gate.smu.OFF)

--##### Model 2470 #2 (drain) setup #####
-- Set up the source function.
drain.smu.source.configlist.create("sweepVals")
drain.smu.source.func = drain.smu.FUNC_DC_VOLTAGE
drain.smu.source.autorange = drain.smu.ON
drain.smu.source.ilimit.level = drainIlimit
-- Set up the measure function.
drain.smu.measure.func = drain.smu.FUNC_DC_CURRENT
drain.smu.measure.autorange = drain.smu.OFF
drain.smu.measure.terminals = drain.smu.TERMINALS_REAR
drain.smu.measure.range = drainIlimit
-- Set up TSP-Link triggering.
drain.tsplink.line[1].mode = drain.tsplink.MODE_SYNCHRONOUS_ACCEPTOR
drain.trigger.tsplinkout[1].stimulus = drain.trigger.EVENT_NOTIFY1
-- Populate the sweepVals source config list, with source levels
-- 0 V to 5 V in 100 mV steps.
for i = drainVstart, drainVstop, drainStepSize do
    drain.smu.source.level = i
    drain.smu.source.configlist.store("sweepVals")
end
local sweepPoints = (drainVstop - drainVstart) * (1 / drainStepSize) + 1
-- Set up the trigger model.
drain.trigger.model.setblock(1, drain.trigger.BLOCK_CONFIG_RECALL, "sweepVals")
drain.trigger.model.setblock(2, drain.trigger.BLOCK_SOURCE_OUTPUT, drain.smu.ON)
drain.trigger.model.setblock(3, drain.trigger.BLOCK_WAIT,
    drain.trigger.EVENT_TSPLINK1)
drain.trigger.model.setblock(4, drain.trigger.BLOCK_DELAY_CONSTANT, 0.01)
drain.trigger.model.setblock(5, drain.trigger.BLOCK_MEASURE)
drain.trigger.model.setblock(6, drain.trigger.BLOCK_CONFIG_NEXT, "sweepVals")
drain.trigger.model.setblock(7, drain.trigger.BLOCK_BRANCH_COUNTER, sweepPoints, 4)
drain.trigger.model.setblock(8, drain.trigger.BLOCK_NOTIFY,
    drain.trigger.EVENT_NOTIFY1)
drain.trigger.model.setblock(9, drain.trigger.BLOCK_BRANCH_COUNTER, stepPoints, 3)
drain.trigger.model.setblock(10, drain.trigger.BLOCK_SOURCE_OUTPUT, drain.smu.OFF)

```

```
-- Start the trigger model for both SMUs and wait until it is complete
drain.trigger.model.initiate()
gate.trigger.model.initiate()
print("Test Running...")
waitcomplete()
-- Print the formatted readings.
if defbuffer1.n == 0 then
    print("\nNo readings in buffer\n")
else
    print(string.format("drainV,\tdrainI(1),\t\t\tdrainV,\tdrainI(2),\t\t\tdrainV,\tdrainI(3),\t\t\tdrainV,\tdrainI(4)"))
    for k = 1, sweepPoints do
        print(
            string.format("%f,\t%f,\t\t\t%f,\t%f,\t\t\t%f,\t%f,\t\t\t%f,\t%f",
                drain.defbuffer1.sourcevalues[k], drain.defbuffer1[k],
                drain.defbuffer1.sourcevalues[k+sweepPoints],
                drain.defbuffer1[k+sweepPoints],
                drain.defbuffer1.sourcevalues[k+sweepPoints*2],
                drain.defbuffer1[k+sweepPoints*2],
                drain.defbuffer1.sourcevalues[k+sweepPoints*3],
                drain.defbuffer1[k+sweepPoints*3]
            )
        )
    end
end
```

Troubleshooting FAQs

In this section:

About this section	7-1
Where can I find updated drivers?.....	7-1
How do I upgrade the firmware?	7-2
Why can't the 2470 read my USB flash drive?	7-2
How do I change the command set?	7-3
Why am I getting a 5074 event code?	7-4
How do I save the present state of the instrument?	7-4
Why did my settings change?.....	7-5
What are the Quick Setup options?	7-6

About this section

This section helps you find answers to the most common questions encountered with the 2470. For additional FAQs, see "Frequently Asked Questions (FAQs)" in the *2470 Reference Manual*.

Where can I find updated drivers?

For the latest drivers and additional support information, see the Keithley Instruments support website.

To see what drivers are available for your instrument:

1. Go to tek.com/support.
2. Enter the model number of your instrument.
3. Select **Software** from the filter list.
4. Select **Driver** from the filter list

NOTE

If you use the native LabVIEW™ or IVI driver, you must configure the 2470 to use the SCPI command set. For information on changing the command set, refer to [How do I change the command set?](#) (on page 7-3)

How do I upgrade the firmware?

CAUTION

Do not turn off power or remove the USB flash drive until the upgrade process is complete.

NOTE

The firmware file must be in the root subdirectory of the flash drive and must be the only firmware file in that location. You can upgrade or downgrade the firmware from the front panel or from the virtual front panel. Refer to "Using the 2470 virtual front panel" in the *2470 Reference Manual* for information.

From the front panel or virtual front panel:

1. Copy the firmware file (.upg file) to a USB flash drive.
2. Verify that the firmware file is in the root subdirectory of the flash drive and that it is the only firmware file in that location.
3. Disconnect any input and output terminals that are attached to the instrument.
4. Turn the instrument power off. Wait a few seconds.
5. Turn the instrument power on.
6. Insert the flash drive into the USB port on the front panel of the instrument.
7. From the instrument front panel, press the **MENU** key.
8. Under System, select **Info/Manage**.
9. Choose an upgrade option:
 - To upgrade to a newer version of firmware, select **Upgrade to New**.
 - To return to a previous version of firmware, select **Downgrade to Older**.
10. If the instrument is controlled remotely, a message is displayed. Select **Yes** to continue.
11. When the upgrade is complete, reboot the instrument.

A message is displayed while the upgrade is in progress.

Upgrade files are available on tek.com/keithley.

Why can't the 2470 read my USB flash drive?

Verify that the flash drive is formatted with the FAT32 file system. The 2470 only supports FAT and FAT32 drives using MBR (Master Boot Record).

In Microsoft® Windows®, you can check the file system by checking the properties of the USB flash drive.

How do I change the command set?

You can change the command set that you use with the 2470. The remote command sets that are available include:

- SCPI: An instrument-specific language built on the SCPI standard.
- TSP: A scripting programming language that contains instrument-specific control commands that can be executed from a stand-alone instrument. You can use TSP to send individual commands or use it to combine commands into scripts.

If you change the command set, reboot the instrument.

You cannot combine the command sets.

NOTE

As delivered from Keithley Instruments, the 2470 is set to work with the SCPI command set.

To set the command set from the front panel:

1. Press the **MENU** key.
2. Under System, select **Settings**.
3. Select the appropriate **Command Set**.

You are prompted to confirm the change to the command set and reboot.

To verify which command set is selected from a remote interface:

Send the command:

```
*LANG?
```

To change to the SCPI command set from a remote interface:

Send the command:

```
*LANG SCPI
```

Reboot the instrument.

To change to the TSP command set from a remote interface:

Send the command:

```
*LANG TSP
```

Reboot the instrument.

Why am I getting a 5074 event code?

The instrument provides an interlock circuit on the rear panel. You must enable this circuit in order for the instrument to set source voltages greater than ± 42 V DC. If you try to assign a high-voltage output and turn the source on when the interlock is not asserted, you see event code 5074, "Output voltage limited by interlock."

WARNING

The 2470 is provided with an interlock circuit that must be positively activated in order for the high voltage output to be enabled. The interlock helps facilitate safe operation of the equipment in a test system. Bypassing the interlock could expose the operator to hazardous voltages that could result in personal injury or death.

If the safety interlock is not asserted and the source is turned on, the following actions occur:

- The nominal output is limited to less than ± 42 V.
- The front-panel INTERLOCK indicator is not illuminated.

To recover from this error, properly engage the interlock using a safe test fixture before turning on the 2470 output.

How do I save the present state of the instrument?

You can save the settings in the instrument as a script using the front-panel menus or from a remote interface. After they are saved, you can recall the script or copy it to a USB flash drive.

From the front panel:

1. Configure the 2470 to the settings that you want to save.
2. Press the **MENU** key.
3. Under Scripts, select **Create Setup**.
4. Select **Create**. A keyboard is displayed.
5. Use the keyboard to enter the name of the script.
6. Select the **OK** button on the displayed keyboard. The script is added to internal memory.

Using SCPI commands:

Configure the instrument to the settings that you want to save. To save the setup, send the command:

```
*SAV <n>
```

Where <n> is an integer from 0 to 4.

NOTE

In the front-panel script menus, the setups saved with the *SAV command have the name Setup0x, where x is the value you set for <n>.

Using TSP commands:

Configure the instrument to the settings that you want to save. To save the setup, send the command:

```
createconfigscript("setupName")
```

Where *setupName* is the name of the setup script that is created.

Why did my settings change?

Many of the commands in the 2470 are saved with the source or measure function that was active when you set them. For example, assume you have the measure function set to current and you set a value for display digits. When you change the measure function to voltage, the display digits value changes to the value that was last set for the voltage measure function. When you return to the current measure function, the display digits value returns to the value you set previously.

What are the Quick Setup options?

The **QUICKSET** key opens a screen that provides access to function selection, performance adjustments, and quick setups.

The Function button on the Quickset menu allows you to select a source or measure function. The options are the same as those available when you use the front-panel **FUNCTION** key.

The Performance slider allows you to adjust speed and resolution. As you increase speed, you lower the amount of resolution. As you increase resolution, you decrease the reading speed. These settings take effect the next time the output is turned on and measurements are made.

The Quick Setups allow you to set the instrument to operate as a Voltmeter, Ammeter, Ohmmeter, or Power Supply.

CAUTION

When you select a Quick Setup, the instrument turns the output on. Carefully consider and configure the appropriate output-off state, source, and limits before connecting the 2470 to a device that can deliver energy, such as other voltage sources, batteries, capacitors, or solar cells. Configure the settings that are recommended for the instrument before making connections to the device. Failure to consider the output-off state, source, and limits may result in damage to the instrument or to the device under test (DUT).

In this section:

[Additional 2470 information.....](#) 8-1

Additional 2470 information

This manual has prepared you to start using your new 2470 High Voltage SourceMeter Instrument for your application. For more detailed information, refer to the Keithley Instruments *2470 Reference Manual*.

Also see tek.com/keithley for support and additional information about the instrument. From the website, you can access:

- The Knowledge Center, which contains the following handbooks:
 - *The Low Level Measurements Handbook: Precision DC Current, Voltage, and Resistance Measurements*
 - *Switching Handbook: A Guide to Signal Switching in Automated Test Systems*
- Application notes
- Updated drivers
- Information about related products

Your local Field Applications Engineer can help you with product selection, configuration, and usage. Check the website for contact information.

Specifications are subject to change without notice.
All Keithley trademarks and trade names are the property of Keithley Instruments.
All other trademarks and trade names are the property of their respective companies.

Keithley Instruments
Corporate Headquarters • 28775 Aurora Road • Cleveland, Ohio 44139 • 440-248-0400 • Fax: 440-248-6168 • 1-800-935-5595 • tek.com/keithley

