

1 2 3 4 5 6

A  
B  
C  
D

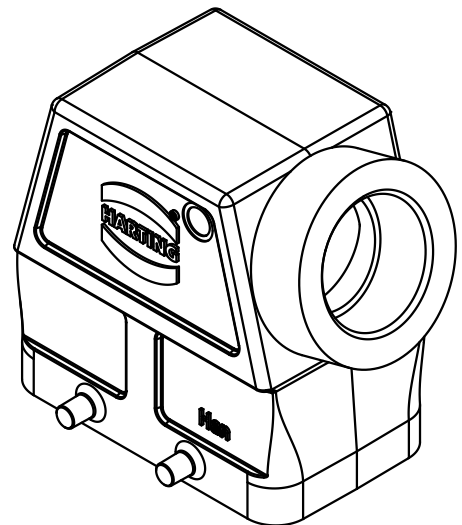
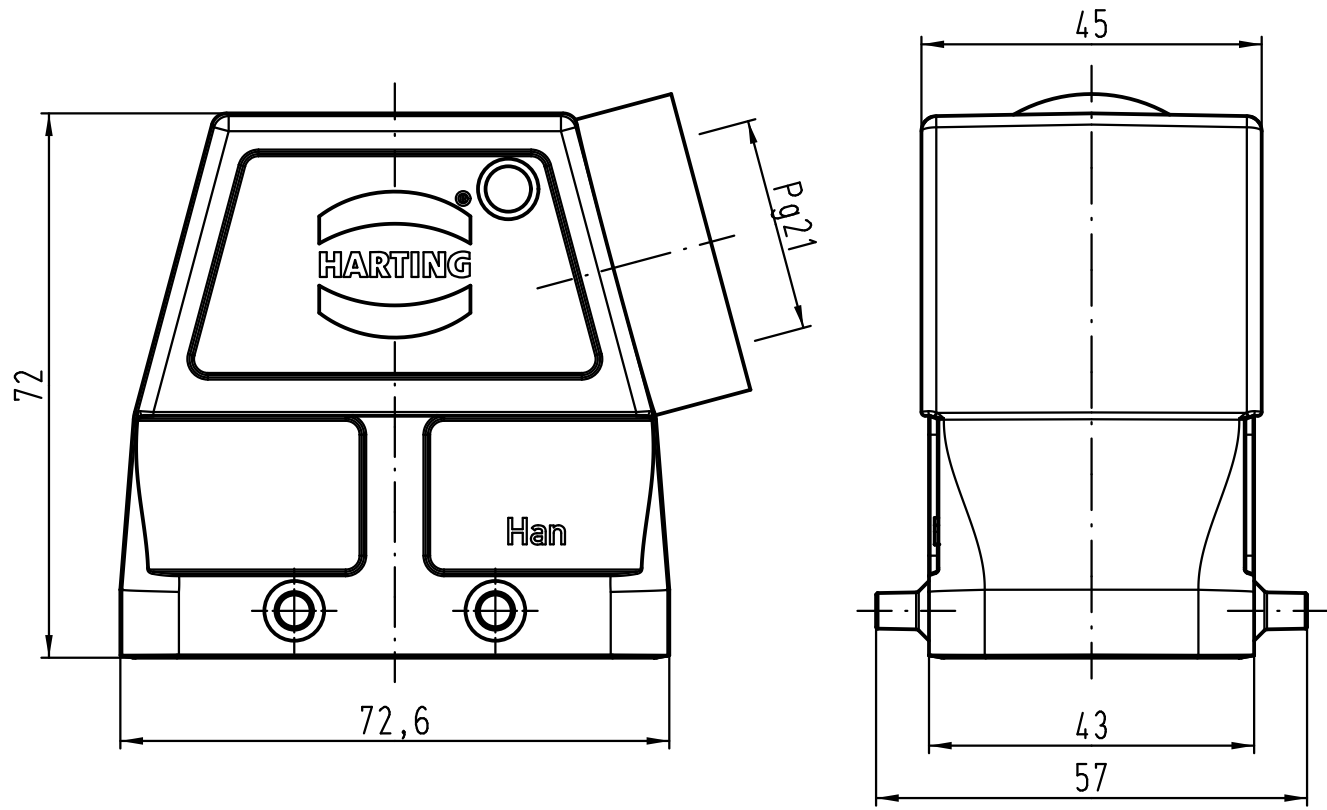

All Dimensions in mm Original Size DIN A 4		Techn. Character.			Nicht tolerierte Maße! Free size tolerances	
			Dat.	Name	Maßstab/Scale  1:1	Han 10B-gs-21 Gehäuse/hood
		Detail.	19.03.12	Ho		
		Insp.		Be		
		Stand.				
A			HARTING Electric GmbH & Co. KG		TB 09 30 010 0522	Blatt/page
Mod.	Dat.	Name	D-32339 Espelkamp			
					Sub. TB 09 30 010 0522 v. 10.06.99	