

102128-1 ✓ ACTIVE

AMPMODU | AMPMODU IV/V

TE Internal #: 102128-1

AMPMODU IV/V, Connector Contact, Socket, Wire-to-Board, 26 – 22 AWG Wire Size, 236.823 – 789.41 CMA Wire Size, .12 – .4 mm² Wire Size, Gold

[View on TE.com >](#)



Connectors > PCB Connectors > Wire-to-Board Connectors > Wire-to-Board Connector Contacts

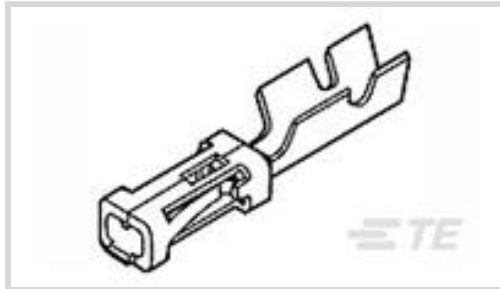

Contact Type: **Socket**

Connector System: **Wire-to-Board**

Wire Size: .12 – .4 mm²

Features

Product Type Features

Applied Pressure	High
Connector System	Wire-to-Board
Connector & Contact Terminates To	Wire & Cable

Configuration Features

Compatible With Wire & Cable Type	Discrete Wire
-----------------------------------	---------------

Electrical Characteristics

Termination Resistance	12 mΩ
Insulation Resistance	5000 MΩ
Dielectric Withstanding Voltage (Max)	750 V
Operating Voltage	250 VAC

Contact Features

Mating Square Post Dimension	.64 mm[.025 in]
	30 μin
Wire Contact Termination Area Plating Material	Gold Flash
Contact Base Material	Phosphor Bronze
Contact Type	Socket
Contact Mating Area Plating Material	Gold
Contact Current Rating (Max)	3 A

Termination Features



Termination Method to Wire & Cable	Crimp
------------------------------------	-------

Mechanical Attachment

Wire Insulation Support	With
-------------------------	------

Dimensions

Accepts Wire Insulation Diameter Range	1.55 mm [.061 in]
--	-------------------

Wire Size	.12 – .4 mm ²
-----------	--------------------------

Usage Conditions

Operating Temperature Range	-65 – 105 °C [-85 – 221 °F]
-----------------------------	-----------------------------

Operation/Application

Circuit Application	Power & Signal
---------------------	----------------

Industry Standards

Approved Standards	CSA LR7189, UL E28476
--------------------	-----------------------

Packaging Features

Packaging Quantity	1000
--------------------	------

Packaging Method	Loose Piece
------------------	-------------

Other

Comment	(*) For use with Model "K" machines. Call the Technical Assistance Center (1-800-522-6752) for any tooling questions.
---------	---

Product Compliance

[For compliance documentation, visit the product page on TE.com>](#)

EU RoHS Directive 2011/65/EU	Compliant
------------------------------	-----------

EU ELV Directive 2000/53/EC	Compliant
-----------------------------	-----------

China RoHS 2 Directive MIIT Order No 32, 2016	No Restricted Materials Above Threshold
---	---

EU REACH Regulation (EC) No. 1907/2006	Current ECHA Candidate List: JAN 2022 (223) Candidate List Declared Against: JAN 2022 (223) Does not contain REACH SVHC
--	---

Halogen Content	Low Halogen - Br, Cl, F, I < 900 ppm per homogenous material. Also BFR/CFR/PVC Free
-----------------	---

Solder Process Capability	Not applicable for solder process capability
---------------------------	--

Product Compliance Disclaimer

This information is provided based on reasonable inquiry of our suppliers and represents our current actual knowledge based on the information they provided. This information is subject to change. The part numbers that TE has identified as EU RoHS compliant have a maximum concentration of 0.1% by weight in homogenous materials for lead, hexavalent chromium, mercury, PBB, PBDE, DBP, BBP, DEHP, DIBP, and 0.01% for cadmium, or qualify for an exemption to these limits as defined in the Annexes of Directive 2011/65/EU (RoHS2). Finished electrical and electronic equipment products will be CE marked as required by Directive 2011/65/EU. Components may not be CE marked. Additionally, the part numbers that TE has identified as EU ELV compliant have a maximum concentration of 0.1% by weight in homogenous materials for lead, hexavalent chromium, and mercury, and 0.01% for cadmium, or qualify for an exemption to these limits as defined in the Annexes of Directive 2000/53/EC (ELV). Regarding the REACH Regulation, the information TE provides on SVHC in articles for this part number is based on the latest European Chemicals Agency (ECHA) 'Guidance on requirements for substances in articles' posted at this URL: <https://echa.europa.eu/guidance-documents/guidance-on-reach>

Compatible Parts



TE Part # 91517-1
CCII FEMALE MOD IV REC 24-22 ASSY



TE Part # 58641-1
PRO-CRIMP TL & DIE MOD IV



TE Part # 843996-3
TOOL, EXTRACTION RESET

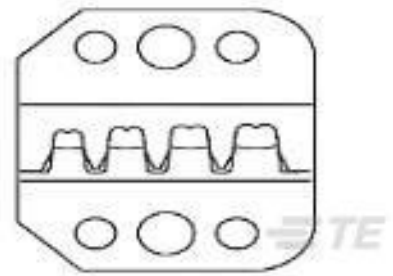

TE Part # 58641-2
PROCRIMP DIE MOD IV

Also in the Series | AMPMODU IV/V



Automotive Housings(2)

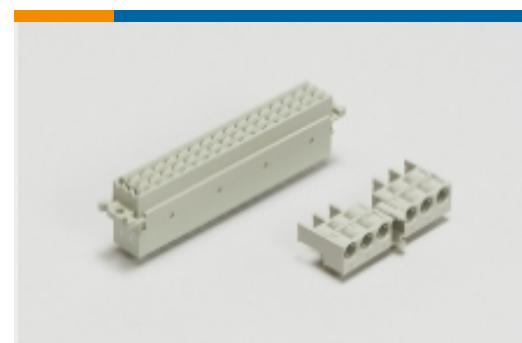

Backplane Connector Housings(1)



Board-to-Board Connector Contacts(6)



Insertion & Extraction Tools(4)

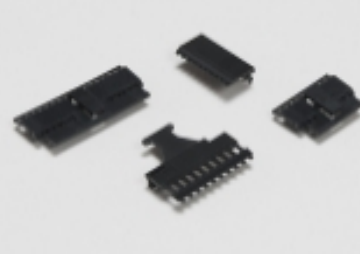

PCB Connector Covers(18)



PCB Connector Keying(6)



PCB Connector Mounting(1)



PCB Connector Strain Relief(3)



PCB Headers & Receptacles(939)

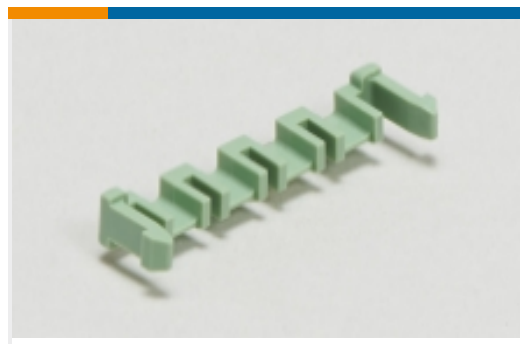

PCB Latches, Locks & Retainers(9)



Rectangular Connector Housings(5)

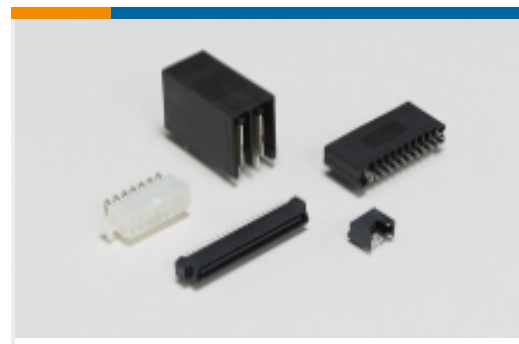

Standard Rectangular Connectors(8)



Wire-to-Board Connector Assemblies & Housings(473)



Wire-to-Board Connector Contacts (328)

Customers Also Bought

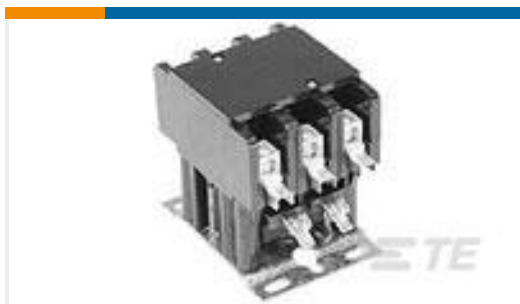

TE Part #5-1611022-0
3100-30K17999CJ=CONTACTOR

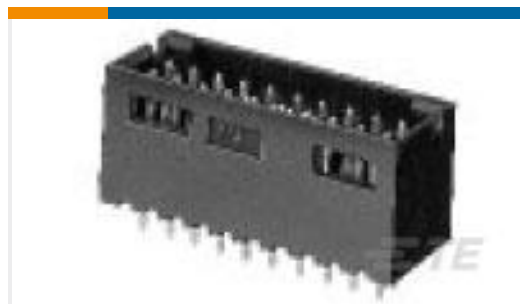

TE Part #102618-5
14 MODII HDR DRST SHRD .100CL

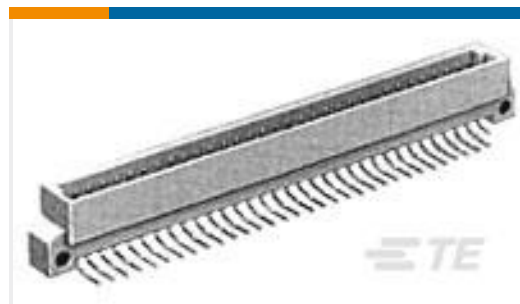

TE Part #5148103-1
ASSY,PIN,EUROCARD,TYPE B,LEAD-



TE Part #3-87977-4
18 MODIV HSG COMP DR .100 POL



TE Part #104068-5
50 SYSTEM 50 HDR DRST SHRD

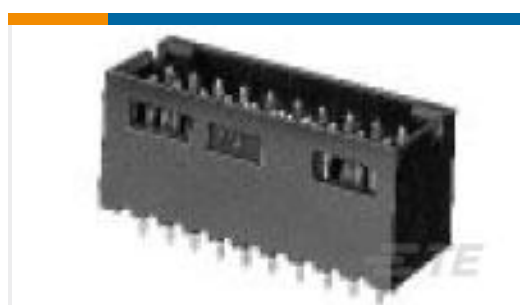

TE Part #5-103168-7
18 MODII HDR DRST SHRD .100CL



TE Part #87499-9
05 MODIV HSG SR MRKD .100CL

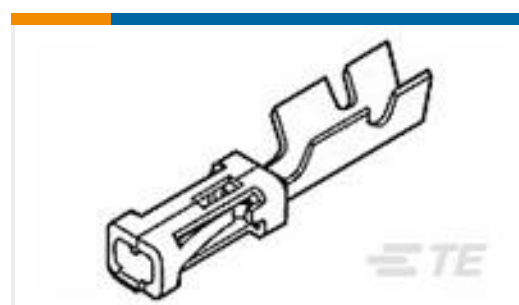

TE Part #87756-5
MOD IV RECP LP



TE Part #2-380937-0
MR SPLT GROMET .312 DIA BLK LF

Documents



Product Drawings

MOD V RECP LP

English

CAD Files

3D PDF

3D

Customer View Model

[ENG_CVM_CVM_102128-1_AF.2d_dxf.zip](#)

English

Customer View Model

[ENG_CVM_CVM_102128-1_AF.3d_igs.zip](#)

English

Customer View Model

[ENG_CVM_CVM_102128-1_AF.3d_stp.zip](#)

English

By downloading the CAD file I accept and agree to the [Terms and Conditions](#) of use.

Datasheets & Catalog Pages

AMP MODU IV & V Section of Catalog 1307819

English

[AMPMODU_INTERCONNECTION_SYSTEM_SECTION5_CONT](#)

English

[1-1773720-9_AMPMODU_MOD_IV_V_QRG](#)

English

Product Specifications

Application Specification

English

Product Environmental Compliance

[MD_102128-1_03302018819_dmtec](#)

English

[MD_102128-1_03302018819_dmtec](#)

English