

LUMOTAST 16, illuminated pushbutton, round collar, momentary contact function, frontring black, 1 NO, bezel red



fields of application

- › Measurement-control-regulation
- › Electrical engineering
- › Mechanical and system engineering
- › Signalling systems
- › Handheld terminals
- › Industrial robots
- › Model construction

special features

- › Illuminated by integrated LED
- › Option: C-LAB variant with replaceable legend inserts
- › Round mounting hole, diameter 16.2 mm
- › Mounting depth: 18 mm
- › Terminal: male quick-connect terminal 2.8 x 0.5 mm
- › Gold or silver contacts
- › Contacts: Standard: 1NO
- › max 35 V / 100 mA
- › Water jet protection class IP 65 and IP 67 on front



description

Through the use of RAFI tactile switches, the LUMOTAST 16 illuminated pushbuttons offer crisp, tactile feedback – with a distinct key click. They offer an impressively wide range of possible industrial uses and applications.

technical data

› general

Bezel color	red
Property of bezel / mushroom	translucent
Collar color	black
Front ring color	black
Luminous element color	white
Collar shape	round
Operating temperature, min.	-25 °C
Operating temperature, max.	70 °C
Storage temperature, min.	-40 °C
Storage temperature, max.	80 °C
illuminated	Yes
Packaging	Box
Packaging unit	10 pcs.
net weight	4.2 g
Operating life	500,000 cycles
B10	600,000 cycles
Degree of protection, front side, according to DIN EN 60529	IP65 IP67

direct links

- › [RAFI eCatalog](#)

UL Enclosure Type Rating front side	type 1
Vibration-resistance according to standard IEC 60068-2-6	5 g at 10 - 500 Hz
MOQ order	50 pcs.
RoHS compliant	Yes
REACH compliant	Yes
> mounting diameters	
Outside dimension, length	23.5 mm
Outside dimension, width	23.5 mm
Outside dimension, height	22.3 mm
Mounting hole	16.2 mm
Mounting depth	18 mm
Installation height	4.6 mm
Collar dimension	23.5 mm
> mechanical data	
Actuation function	momentary contact function
Contact function	1 NO
Contact system	Snap-action contact
Contact material	Gold
Fixing	Threaded ring
Solderability	No
Threaded ring torque, max.	0.8 Nm
Terminal on the rear	Flat quick-connect terminal 2.8 x 0.5
> electrical data	
Rated insulation voltage	42 V
Operating voltage of the luminous element, min.	10 V
Operating voltage of the luminous element, max.	32 V
Rated voltage, min.	0.02 V
Rated voltage, max.	35 V
Rated voltage, max. acc. to UL 60947	30 V AC (42,2 V peak)
Operating current of the luminous element, min.	18 mA
Operating current of the luminous element, max.	25 mA
Rated current, min.	0.0001 A
Rated current, max.	0.1 A
Rated power, max.	1 W

drawings

Dimensioned drawing

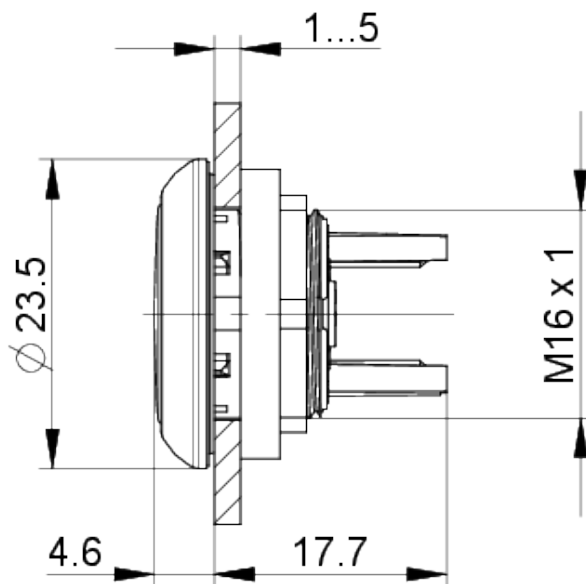

Mounting hole drawing



Schematic diagram

