

1445251-1 ✓ ACTIVE

AMPMODU

TE Internal #: 1445251-1

PCB Connector Mounting, Organizer, Board-to-Board, 104

Position, .1 in [2.54 mm] Centerline, Black, Signal, Board Mount, -55

- 105 °C [-67 - 221 °F]

[View on TE.com >](#)



Connectors > PCB Connectors > PCB Connector Accessories > PCB Connector Hardware > Mounting

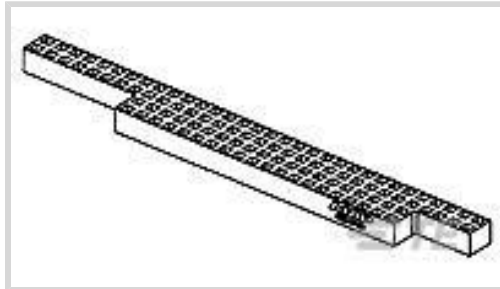

Connector Mounting Accessory Type: **Organizer**

Connector System: **Board-to-Board**

Number of Positions: **104**

Centerline (Pitch): **2.54 mm [.1 in]**

Primary Product Color: **Black**

Features

Product Type Features

Connector Mounting Accessory Type	Organizer
Connector System	Board-to-Board
Sealable	No

Configuration Features

Number of Positions	104
---------------------	-----

Body Features

Primary Product Material	PBT GF
Primary Product Color	Black

Mechanical Attachment

Connector Mounting Type	Board Mount
-------------------------	-------------

Housing Features

Centerline (Pitch)	2.54 mm[.1 in]
--------------------	----------------

Usage Conditions

Operating Temperature Range	-55 - 105 °C[-67 - 221 °F]
-----------------------------	----------------------------

Operation/Application

Circuit Application	Signal
---------------------	--------

Industry Standards



UL Flammability Rating	UL 94V-0
------------------------	----------

Packaging Features

Packaging Quantity	1
Packaging Method	Package

Other

Comment	See Specific Info Link for information on a PC/104 Extraction Tool.
---------	---

Product Compliance

[For compliance documentation, visit the product page on TE.com>](#)

EU RoHS Directive 2011/65/EU	Compliant
EU ELV Directive 2000/53/EC	Compliant
China RoHS 2 Directive MIIT Order No 32, 2016	No Restricted Materials Above Threshold
EU REACH Regulation (EC) No. 1907/2006	Current ECHA Candidate List: JAN 2022 (223) Candidate List Declared Against: JAN 2022 (223) Does not contain REACH SVHC
Halogen Content	Not Low Halogen - contains Br or Cl > 900 ppm.
Solder Process Capability	Not applicable for solder process capability

Product Compliance Disclaimer

This information is provided based on reasonable inquiry of our suppliers and represents our current actual knowledge based on the information they provided. This information is subject to change. The part numbers that TE has identified as EU RoHS compliant have a maximum concentration of 0.1% by weight in homogenous materials for lead, hexavalent chromium, mercury, PBB, PBDE, DBP, BBP, DEHP, DIBP, and 0.01% for cadmium, or qualify for an exemption to these limits as defined in the Annexes of Directive 2011/65/EU (RoHS2). Finished electrical and electronic equipment products will be CE marked as required by Directive 2011/65/EU. Components may not be CE marked. Additionally, the part numbers that TE has identified as EU ELV compliant have a maximum concentration of 0.1% by weight in homogenous materials for lead, hexavalent chromium, and mercury, and 0.01% for cadmium, or qualify for an exemption to these limits as defined in the Annexes of Directive 2000/53/EC (ELV). Regarding the REACH Regulation, the information TE provides on SVHC in articles for this part number is based on the latest European Chemicals Agency (ECHA) 'Guidance on requirements for substances in articles' posted at this URL: <https://echa.europa.eu/guidance-documents/guidance-on-reach>

Compatible Parts

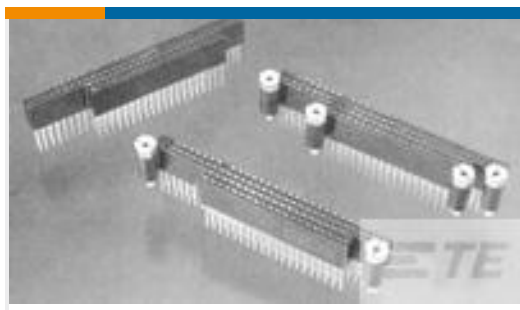

TE Part # 1375795-4
PC104 ASY STKTHRU UNKEYED LF

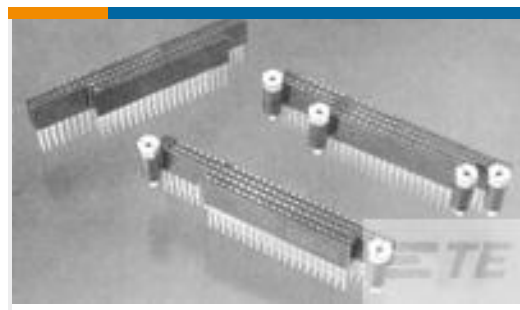

TE Part # 1375795-3
ASSY, 64/40 POS PC104 LF

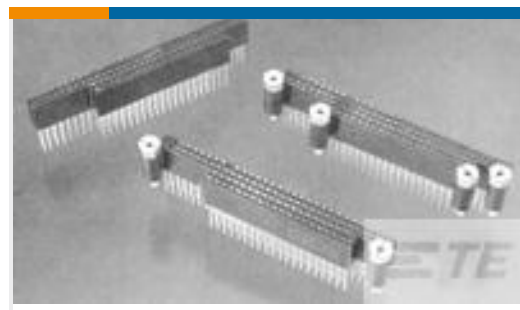

TE Part # 1375793-3
ASSY, 64/40 POS PC104 LF

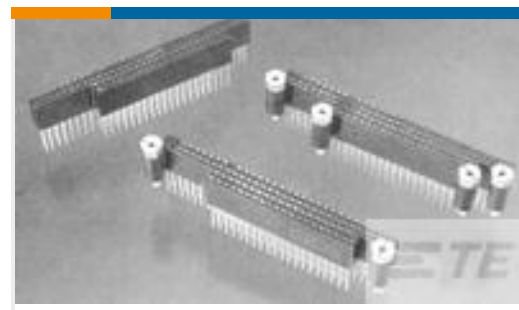

TE Part # 1375793-4
PC104 ASY 2S/0 STKTHR UNKEY LF

Customers Also Bought



TE Part #1721081-9
PCJ-105D3MH,301



TE Part #4-2176231-9
3522 1K0 1% 3W

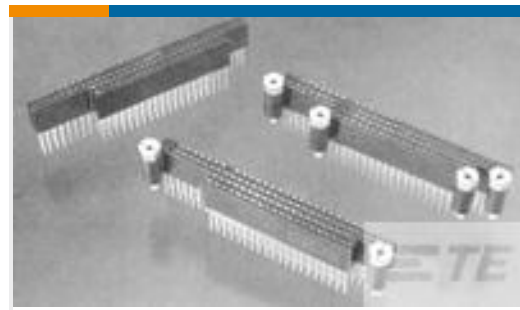

TE Part #1375795-5
PC104 ASY STKTHRU UNKEYED



TE Part #87224-2
02 MODII HDR SRST UNSHRD .100

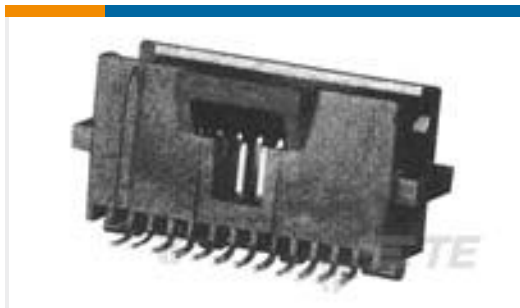

TE Part #5-147377-1
10 SYS50 SMT HDR DR SHD SN



TE Part #5677954003
RNF-3000-24/8-X-SP

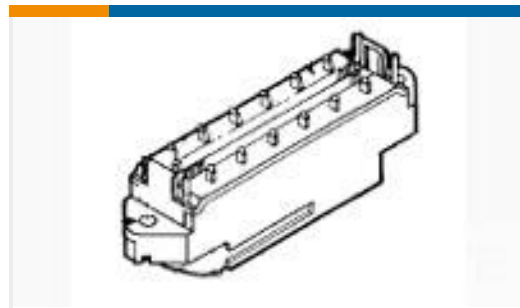

TE Part #553602-1
PLUG ASSY,50 POSN,SCR LK,L PF



TE Part #5053052016
RNF-100-3/16-2-STK



TE Part #530153-2
TDM SPRING SHUNT ASSY 2 POS

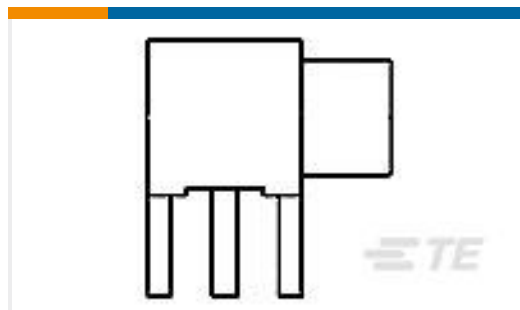

TE Part #1061030-1
5864 5003 10,OSX PCB RA JACK

Documents

Product Drawings
[ORGANIZER PC/104](#)

English

CAD Files

[3D PDF](#)

English

Customer View Model

[ENG_CVM_1445251-1_O.2d_dxf.zip](#)



English

Customer View Model

[ENG_CVM_1445251-1_O.3d_igs.zip](#)

English

Customer View Model

[ENG_CVM_1445251-1_O.3d_stp.zip](#)

English

By downloading the CAD file I accept and agree to the [Terms and Conditions](#) of use.

Datasheets & Catalog Pages

[AMPMODU_INTERCONNECTION_SYSTEM_SECTION1AND2](#)

English

Product Specifications

[Application Specification](#)

English