

1445389-3 ✓ ACTIVE

AMP | AMP CPC

TE Internal #: 1445389-3

AMP CPC, Circular Power Connectors, Housing, 250 VDC, 30 – 18

AWG Wire Size, .0509 – .823 mm² Wire Size, Wire-to-Wire, 4

Position, Sealable

[View on TE.com >](#)



Connectors > Power Connectors > Circular Power > Circular Power Connectors > MINI CPC



Connector Product Type: **Housing**

Operating Voltage: **250 VDC**

Wire Size: **.0509 – .823 mm²**

Connector System: **Wire-to-Wire**

[All MINI CPC \(53\)](#)

Features

Product Type Features

Connector Product Type	Housing
Connector System	Wire-to-Wire
Sealable	Yes
Connector & Contact Terminates To	Wire & Cable
Connector & Housing Type	Receptacle
Circular Connector Shell Type	All Plastic

Configuration Features

Number of Positions	4
Number of Power Positions	0
Seal Type	Peripheral, Wire Entry Seal
Number of Signal Positions	4

Electrical Characteristics

Operating Voltage	250 VAC
-------------------	---------



Contact Features

Reverse Gender	No
Contact Type	Pin
Contact Current Rating (Max)	7.5 A

Termination Features

Termination Method to Wire & Cable	Crimp
------------------------------------	-------

Mechanical Attachment

Screw & Hole Thread Size	1/2-20 UNF-2A
Mating Alignment	With
Mating Retention	With
Panel Mount Feature	Without
Mating Retention Type	Threaded Coupling

Housing Features

Housing Color	Black
Housing Material	Thermoplastic
Circular Connector Shell Size	8

Dimensions

Wire Size	.0509 – .823 mm ²
Accepts Wire Insulation Diameter Range	1.5 – 2.39 mm [.059 – .11 in]

Usage Conditions

Operating Temperature Range	-55 – 105 °C [-67 – 221 °F]
Fluid Resistance	Immersion

Operation/Application

Circuit Application	Power & Signal
Shielded	No

Industry Standards

UL Flammability Rating	UL 94V-0
------------------------	----------

Packaging Features

Packaging Method	Bag
Packaging Quantity	800

Product Compliance







[For compliance documentation, visit the product page on TE.com>](#)

EU RoHS Directive 2011/65/EU	Compliant
EU ELV Directive 2000/53/EC	Compliant
China RoHS 2 Directive MIIT Order No 32, 2016	No Restricted Materials Above Threshold
EU REACH Regulation (EC) No. 1907/2006	Current ECHA Candidate List: JAN 2022 (223) Candidate List Declared Against: JUL 2021 (219) SVHC > Threshold: Not Yet Reviewed
Halogen Content	Not Low Halogen - contains Br or Cl > 900 ppm.
Solder Process Capability	Not reviewed for solder process capability

Product Compliance Disclaimer

This information is provided based on reasonable inquiry of our suppliers and represents our current actual knowledge based on the information they provided. This information is subject to change. The part numbers that TE has identified as EU RoHS compliant have a maximum concentration of 0.1% by weight in homogenous materials for lead, hexavalent chromium, mercury, PBB, PBDE, DBP, BBP, DEHP, DIBP, and 0.01% for cadmium, or qualify for an exemption to these limits as defined in the Annexes of Directive 2011/65/EU (RoHS2). Finished electrical and electronic equipment products will be CE marked as required by Directive 2011/65/EU. Components may not be CE marked. Additionally, the part numbers that TE has identified as EU ELV compliant have a maximum concentration of 0.1% by weight in homogenous materials for lead, hexavalent chromium, and mercury, and 0.01% for cadmium, or qualify for an exemption to these limits as defined in the Annexes of Directive 2000/53/EC (ELV). Regarding the REACH Regulation, the information TE provides on SVHC in articles for this part number is based on the latest European Chemicals Agency (ECHA) 'Guidance on requirements for substances in articles' posted at this URL: <https://echa.europa.eu/guidance-documents/guidance-on-reach>

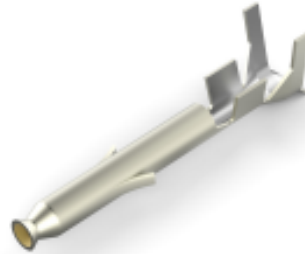
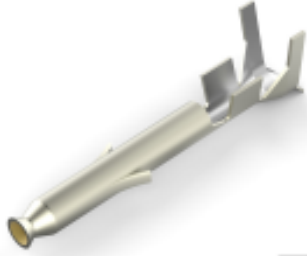
Compatible Parts

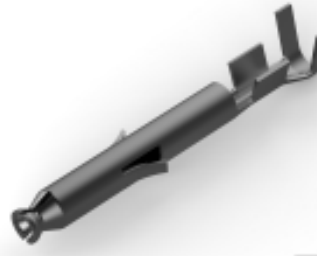
 <p>TE Part # CAT-AM71-C83998EE MINI CPC</p>	 <p>TE Part # 1604089-1 CAP,DUST,SIZE 8</p>	 <p>TE Part # 1445420-1 SEAL,FLANGE, SIZE 8/M13.5</p>	 <p>TE Part # 770988-3 MINI UMNL SOK 22-18AWG AU LP</p>
 <p>TE Part # 1-770988-0 MINI UMNL SOK 22-18AWG AU</p>	 <p>TE Part # 1-794059-0 MINI UMNL PIN L/P LF</p>	 <p>TE Part # 770988-1 MINI UMNL SOK 22-18AWG SN LP</p>	 <p>TE Part # 770986-1 MINI UMNL SOK 26-22AWG SN LP</p>

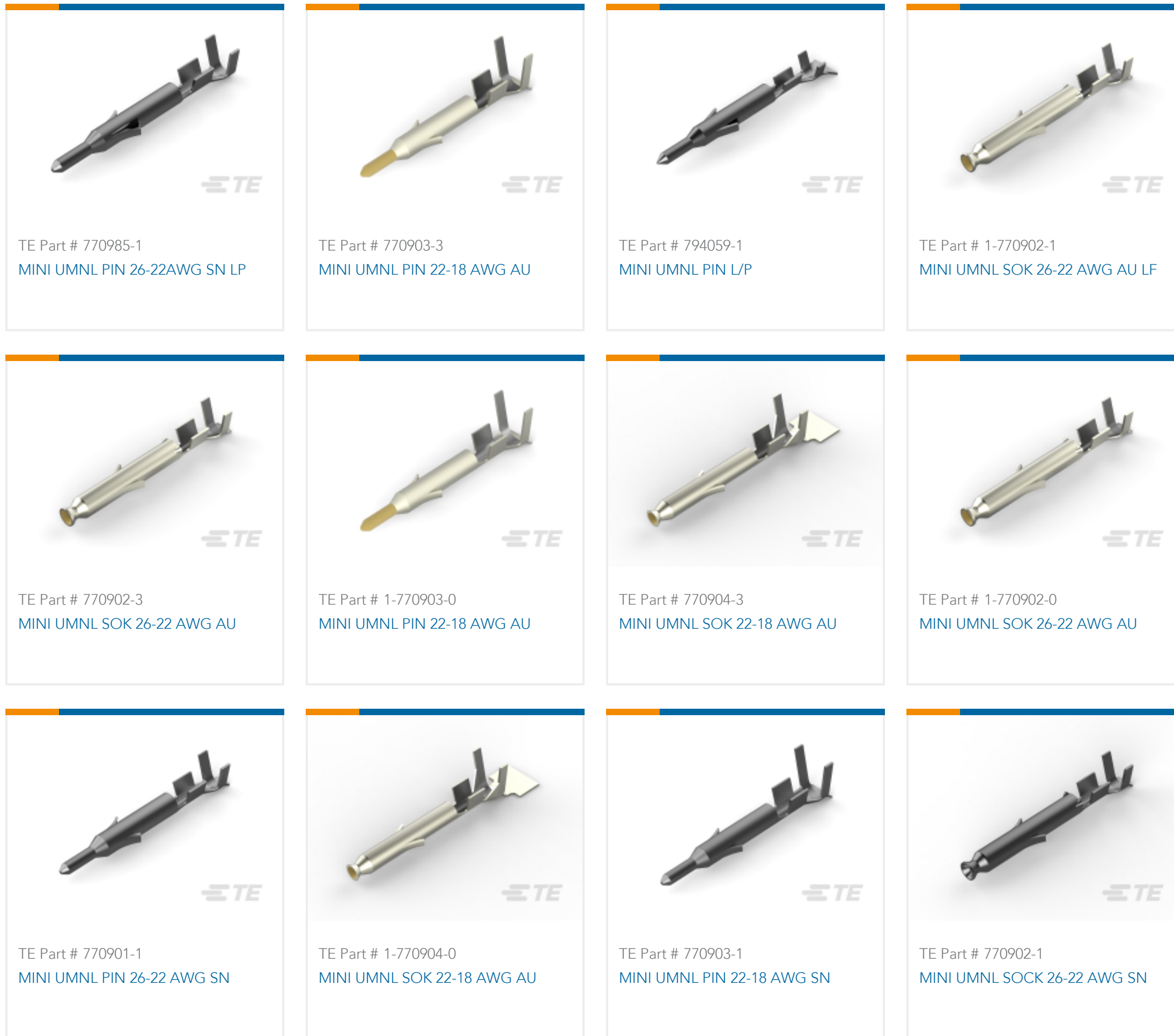

Also in the Series | AMP CPC

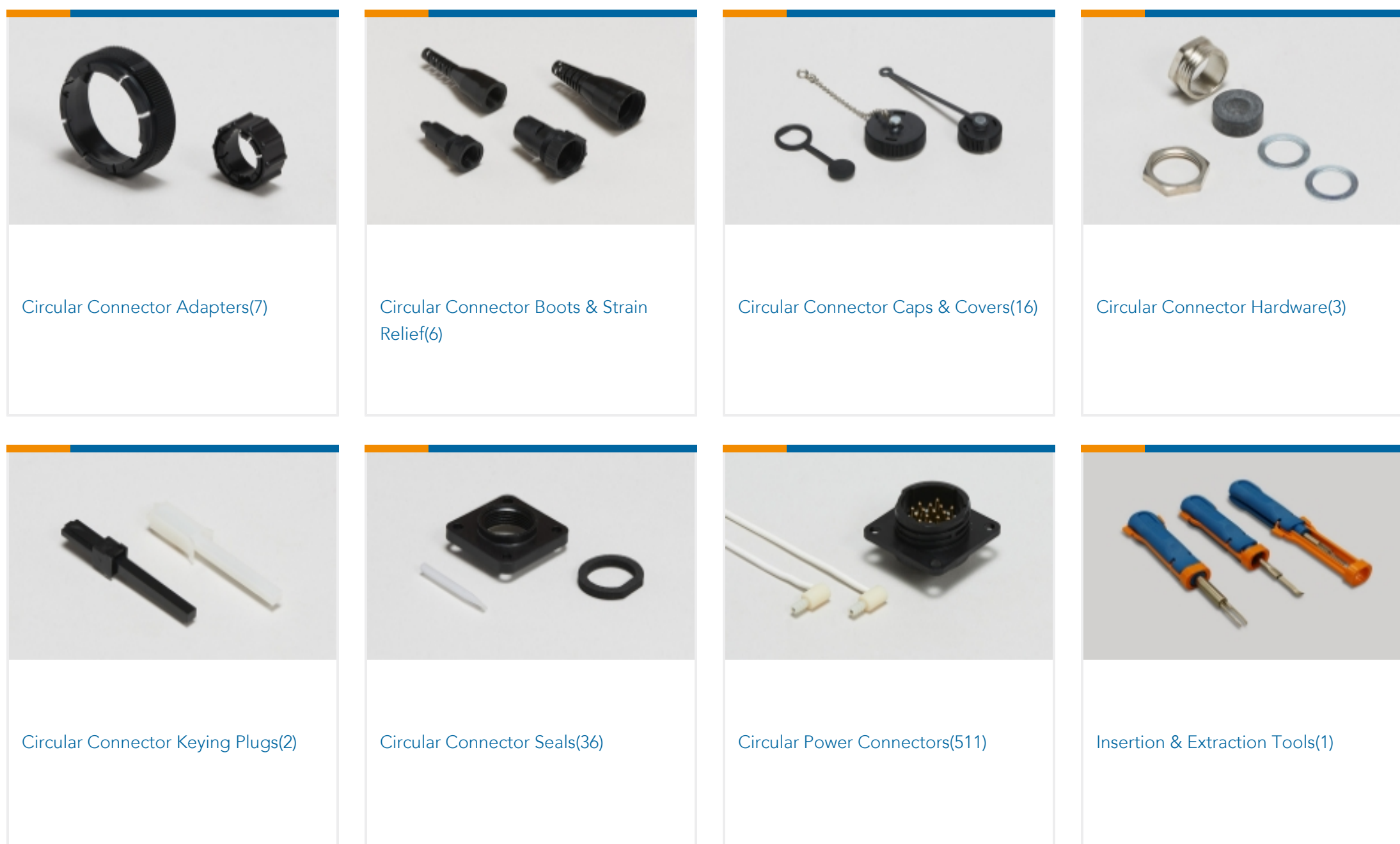

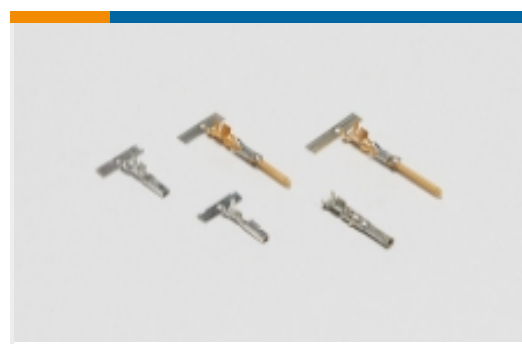

Power Contacts(6)

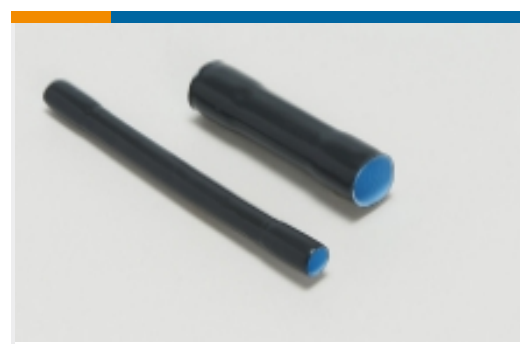

Sealing Sleeves(2)



Unscreened Circular Connector Backshells & Clamps(5)

Customers Also Bought

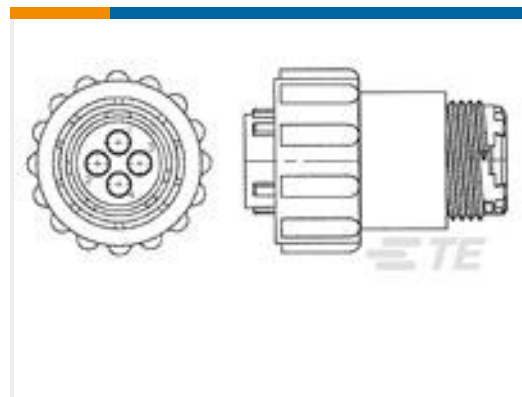

TE Part #1977884-1
SLD CPC PLUG ASSY,13-9,STD SEX,
UV RESIS



TE Part #1445534-1
MINI CPC



TE Part #4-1609157-9
15EJT8F=F8145C

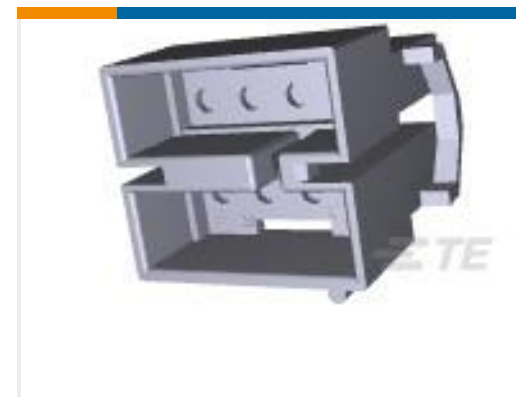

TE Part #1-480284-0
08P CMNL CAP HSG M/M NATL



TE Part #1-794059-0
MINI UMNL PIN L/P LF

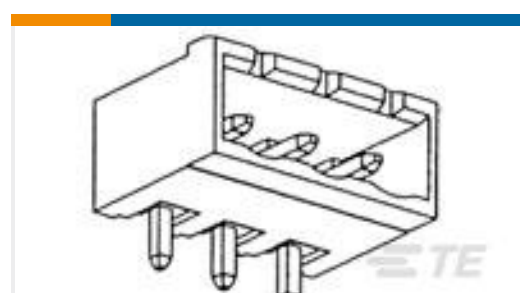

TE Part #796644-3
3POS 5.0MM CE R/A HDR, TRM BLK

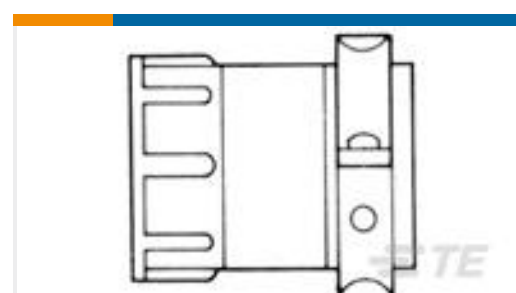

TE Part #207008-6
CABLE CLAMP KIT, BULK PKG



TE Part #1583095-1
DIE ASSEMBLY, AMPPOWER, 1/0

Documents

Product Drawings

[REC,8-4,FREE HG,LG INS,STD KEY](#)

English

CAD Files

Customer View Model

[ENG_CVM_CVM_1445389-3_C1.2d_dxf.zip](#)

English

3D PDF

3D

Customer View Model

[ENG_CVM_CVM_1445389-3_C1.3d_igs.zip](#)

English

Customer View Model

[ENG_CVM_CVM_1445389-3_C1.3d_stp.zip](#)

English

By downloading the CAD file I accept and agree to the [Terms and Conditions](#) of use.



Datasheets & Catalog Pages

[1-1773902-9_CPC_Catalog](#)

German

[1-1773902-9_CPC_Catalog](#)

English

[1-1773902-9_CPC_Catalog](#)

[1-1773902-9_CPC_Catalog](#)

Japanese

[AMP Circular Connectors for Commercial Signal & Power Applications Continued](#)

English

Product Specifications

[Application Specification](#)

English