

1586848-1 ✓ ACTIVE

MATE-N-LOK | Universal MATE-N-LOK

TE Internal #: 1586848-1

Rectangular Power Connectors, Housing, Plug, Wire-to-Wire / Wire-to-Board, 12 Position, 6.35 mm [.25 in] Centerline, Universal MATE-N-LOK

[View on TE.com >](#)



Connectors > Power Connectors > Rectangular Power > Rectangular Power Connectors

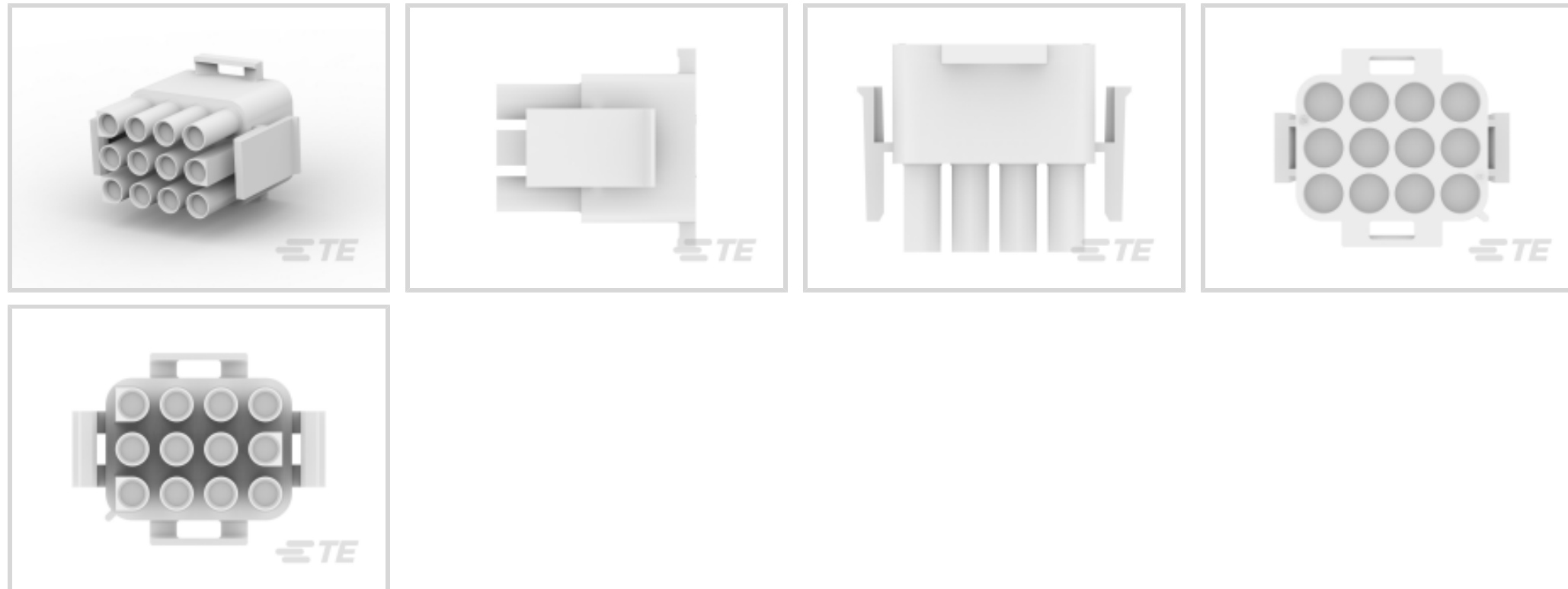

Rectangular Power Connector Type: **Housing**

Connector & Housing Type: **Plug**

Connector System: **Wire-to-Board, Wire-to-Wire**

Number of Positions: **12**

Centerline (Pitch): **6.35 mm [.25 in]**

Features

Product Type Features

Rectangular Power Connector Type	Housing
Connector & Housing Type	Plug
Connector System	Wire-to-Board, Wire-to-Wire
Sealable	No
Connector & Contact Terminates To	Wire & Cable

Configuration Features

Number of Positions	12
Number of Rows	3

Electrical Characteristics

Operating Voltage	600 VAC
-------------------	---------

Contact Features

Multiple Contact Types	Without
Contact Layout	Matrix
Contact Retention Within Housing	Without



Contact Type	Socket
--------------	--------

Termination Features

Termination Method to Wire & Cable	Crimp
------------------------------------	-------

Mechanical Attachment

Connector Mounting Type	Cable Mount (Free-Hanging)
-------------------------	----------------------------

Housing Features

Centerline (Pitch)	6.35 mm [.25 in]
--------------------	------------------

Housing Color	Natural
---------------	---------

Housing Material	Nylon
------------------	-------

Dimensions

	.03 – .09 in
--	--------------

Row-to-Row Spacing	6.35 mm [.25 in]
--------------------	------------------

Usage Conditions

Operating Temperature Range	-55 – 105 °C [-67 – 221 °F]
-----------------------------	-----------------------------

Operation/Application

Circuit Application	Power & Signal
---------------------	----------------

Industry Standards

CSA Rating	Certified, LR 7189
------------	--------------------

UL Rating	Recognized
-----------	------------

Agency/Standard	CSA, UL, VDE
-----------------	--------------

Approved Standards	UL E28476
--------------------	-----------

UL Flammability Rating	UL 94V-2
------------------------	----------

Glow Wire Rating	GWT 750°C (Without Flame)
------------------	---------------------------

Packaging Features

Packaging Quantity	1
--------------------	---

Packaging Method	Package
------------------	---------

Product Compliance

[For compliance documentation, visit the product page on TE.com>](#)

EU RoHS Directive 2011/65/EU	Compliant
------------------------------	-----------

EU ELV Directive 2000/53/EC	Compliant
-----------------------------	-----------



China RoHS 2 Directive MIIT Order No 32, 2016	No Restricted Materials Above Threshold
EU REACH Regulation (EC) No. 1907/2006	Current ECHA Candidate List: JAN 2023 (233) Candidate List Declared Against: JAN 2023 (233) Does not contain REACH SVHC
Halogen Content	Not Low Halogen - contains Br or Cl > 900 ppm.
Solder Process Capability	Not applicable for solder process capability

Product Compliance Disclaimer

This information is provided based on reasonable inquiry of our suppliers and represents our current actual knowledge based on the information they provided. This information is subject to change. The part numbers that TE has identified as EU RoHS compliant have a maximum concentration of 0.1% by weight in homogenous materials for lead, hexavalent chromium, mercury, PBB, PBDE, DBP, BBP, DEHP, DIBP, and 0.01% for cadmium, or qualify for an exemption to these limits as defined in the Annexes of Directive 2011/65/EU (RoHS2). Finished electrical and electronic equipment products will be CE marked as required by Directive 2011/65/EU. Components may not be CE marked. Additionally, the part numbers that TE has identified as EU ELV compliant have a maximum concentration of 0.1% by weight in homogenous materials for lead, hexavalent chromium, and mercury, and 0.01% for cadmium, or qualify for an exemption to these limits as defined in the Annexes of Directive 2000/53/EC (ELV). Regarding the REACH Regulation, the information TE provides on SVHC in articles for this part number is based on the latest European Chemicals Agency (ECHA) 'Guidance on requirements for substances in articles' posted at this URL: <https://echa.europa.eu/guidance-documents/guidance-on-reach>

Compatible Parts

 <p>TE Part # 1-480708-9 12P UMNL PLUG HSG BLK</p>	 <p>TE Part # 770055-1 12P UMNL II CAP-FRONT 94VO</p>	 <p>TE Part # 350783-1 12P UMNL CAP HSG</p>	 <p>TE Part # 926681-3 12P UNIV.CAP HSG.</p>
 <p>TE Part # 1-480708-2 12P UMNL PLUG HSG RED</p>	 <p>TE Part # 770029-1 12P UMNLII IN-LINE CAP HSG KIT</p>	 <p>TE Part # 1586846-1 06P UMNL PLUG HSG NATL, GW</p>	 <p>TE Part # 2-480708-0 12P UMNL PLUG HSG NATL</p>



Also in the Series | **Universal MATE-N-LOK**

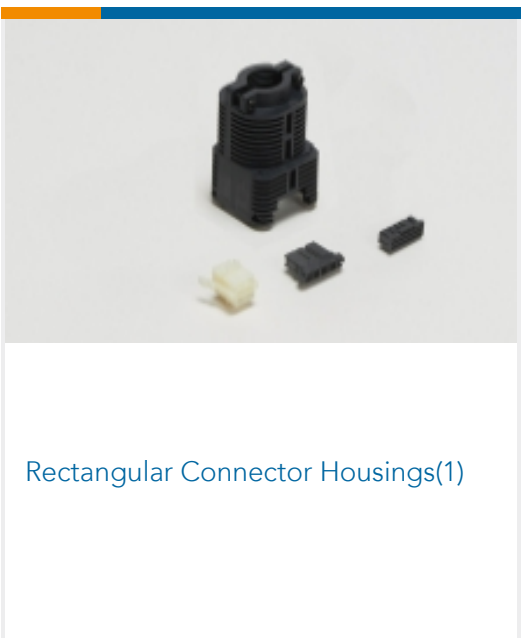
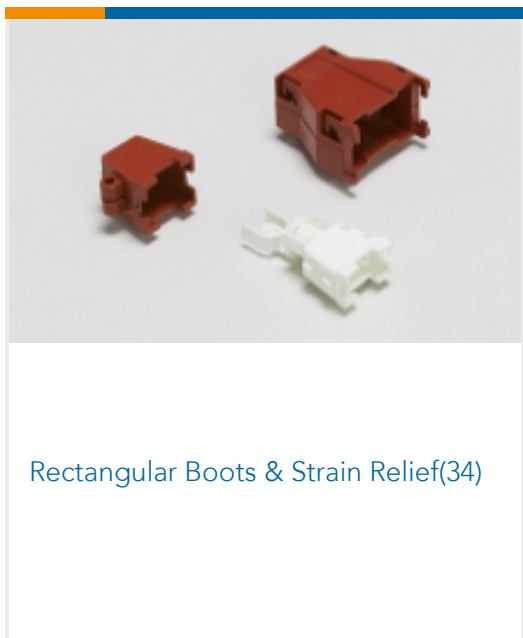
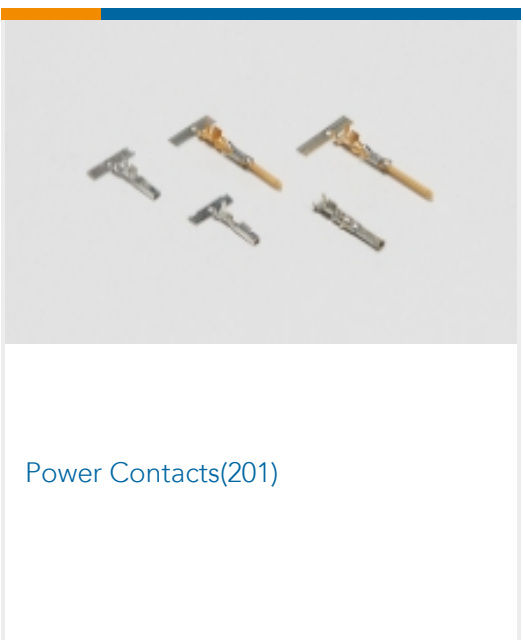
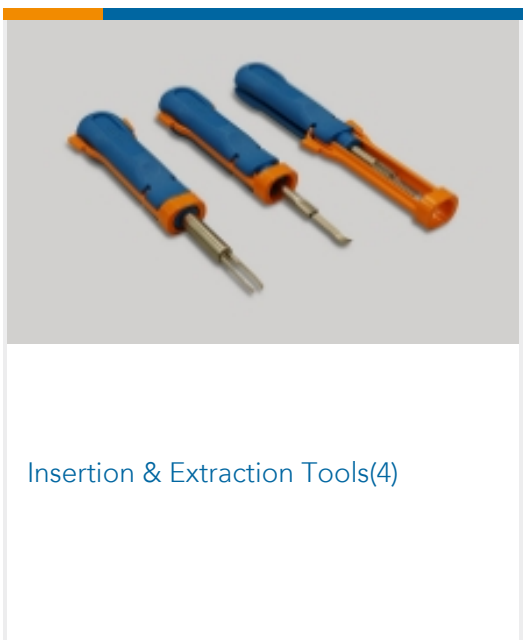
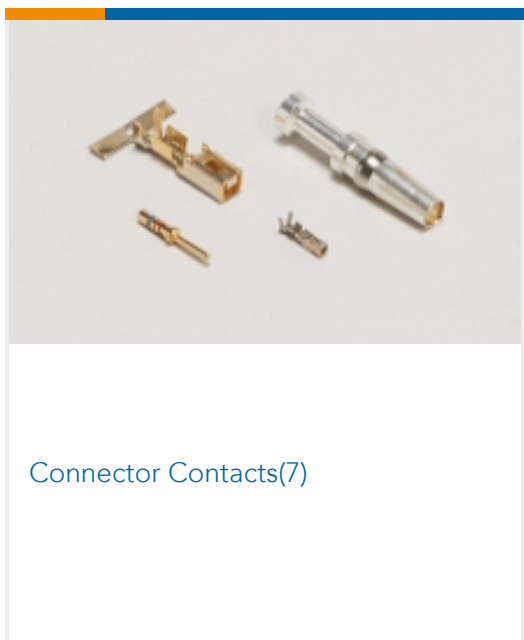
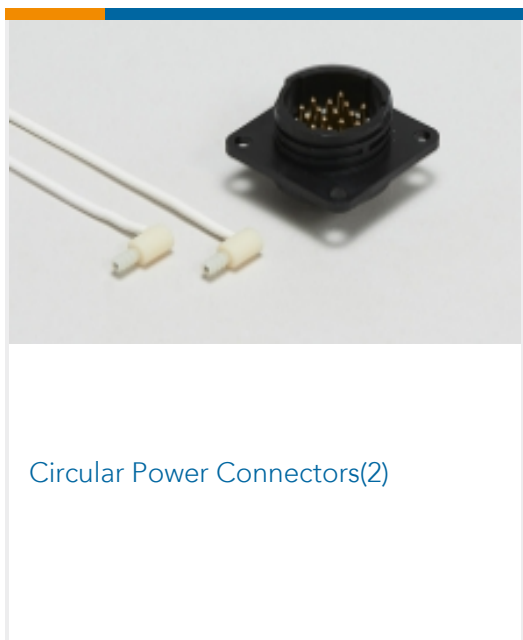

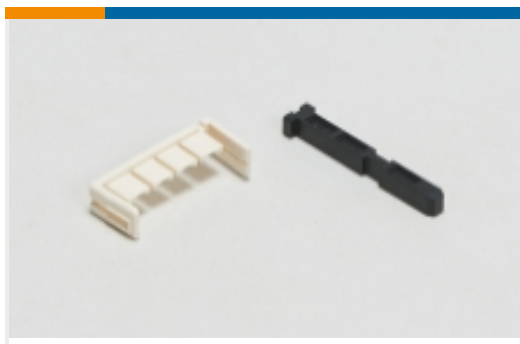

Rectangular Connector Keying Plugs(3)

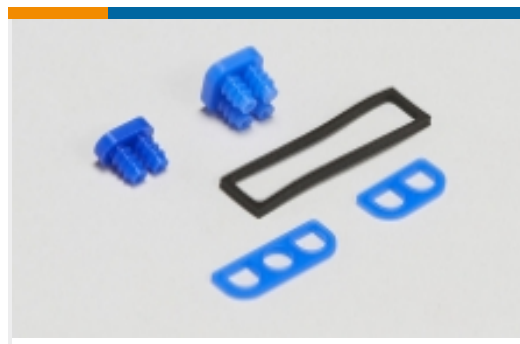

Rectangular Connector Seals(26)



Rectangular Power Connectors(662)

Customers Also Bought



TE Part #1644055-1
UNIV MATE-N-LOK HOUSING 6W



TE Part #1-640723-0
12P UMNL STR/REL & INSRT NATL



TE Part #1586860-1
06P UMNL CAP HSG, GW



TE Part #1586847-1
03P UMNL PLUG HSG, GW

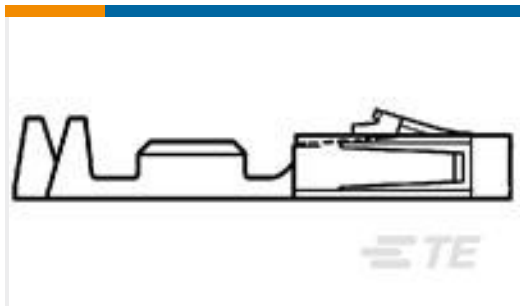

TE Part #104480-2
SHORT POINT CONT PLTD SN-PB

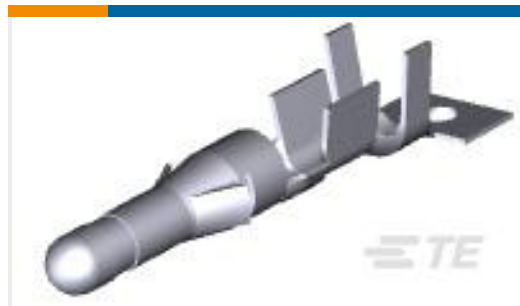

TE Part #770145-1
.093 COMM P&S PIN PTPBR LP



TE Part #T4162123005-005
RPC-M12-5MS-5.0SH-M12-5FS-PUR



TE Part #6149234001
CGPT-12/4-2-SP

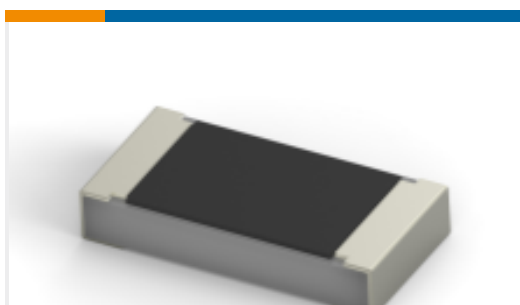

TE Part #4-1614958-4
CPF 0805 2R74 0.1% 25ppm 1K RL



TE Part #207563-1
RECP,3 POSN,ECONOSEAL

Documents

Product Drawings

[12P UMNL PLUG HSG, GW](#)

English

CAD Files

Customer View Model

[ENG_CVM_1586848-1_A.3d_igs.zip](#)

English

Customer View Model



[ENG_CVM_1586848-1_A.3d_stp.zip](#)

English

Customer View Model

[ENG_CVM_1586848-1_A.2d_dxf.zip](#)

English

3D PDF

English

3D PDF

3D

Customer View Model

[ENG_CVM_CVM_1586848-1_B.2d_dxf.zip](#)

English

Customer View Model

[ENG_CVM_CVM_1586848-1_B.3d_igs.zip](#)

English

Customer View Model

[ENG_CVM_CVM_1586848-1_B.3d_stp.zip](#)

English

By downloading the CAD file I accept and agree to the [Terms and Conditions](#) of use.

Product Specifications

[Application Specification](#)

English

Product Environmental Compliance

[TE Material Declaration](#)

English