













## Datasheet

# RS PRO SY21 2-Hole Flanged Panel Mount Connector



## Technical Specifications:

Number of contact	2	3	4	5	5B	5C	6	6B	7	8	9	12	15
Male contact face view													
Rated current (A)	30	30	30	30	30 5	15	25 5	30 5	15	10	5	5	5
Contact diameter (mm)	∅3X2	∅3X3	∅3X4	∅3X5	∅3X2 ∅1X3	∅2X5	∅2.5X4 ∅1X2	∅3X2 ∅1X4	∅2X7	∅1.5X10	∅1X9	∅1X12	∅1X15
Rated voltage (AC.V)	500	500	500	500	500	500	500	500	500	500	400	400	400
Test voltage(AC.V) 1 min	1500	1500	1500	1500	1500	1500	1500	1500	1500	1500	1500	1200	1200
Contact resistance (mΩ)	1	1	1	1	1 5	2.5	1 5	1 5	2.5	2.5	5	5	5
Termination	solder / screw	solder / screw	solder / screw	solder / screw	solder	solder	solder	solder	solder	solder	solder	solder	solder
Wire size for solder (mm <sup>2</sup> / AWG)	≤4/11	≤4/11	≤4/11	≤4/11	≤4/11 ≤0.75/18	≤2/14	≤4/11 ≤0.75/18	≤4/11 ≤0.75/18	≤2/14	≤2/14	<0.75/18	<0.75/18	<0.75/18
Wire size for screw termination (mm <sup>2</sup> / AWG)	≤1.5/15	≤1.5/15	≤1.5/15	≤1.5/15	/	/	/	/	/	/	/	/	/

## Product Details

The RS Pro SY21 series is a range of lightweight but robust waterproof connectors, which are sealed to IP67. Bayonet coupling ensures a quick and secure connection, even in the harshest environments. Versions are available for in-line cable to cable and for cable to panel connections. Plugs and receptacles are available with either male pins or female sockets. These products are ideal for use in outdoor applications where a secure, waterproof connection is required.

## Features and Benefits

- Bayonet Coupling
- IP67
- 2-15 Poles
- Cable to Cable and Cable to Panel Connections



## Dimensional line drawings

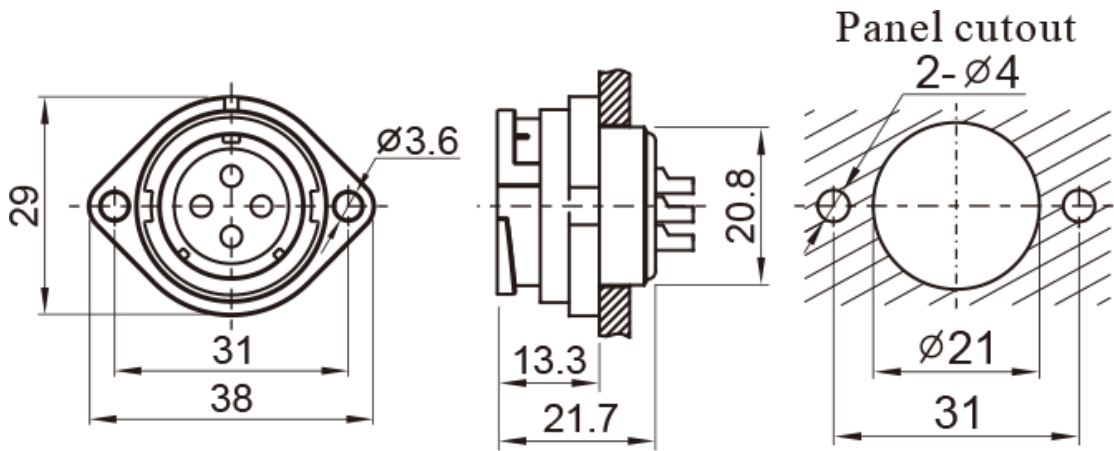

## Quality Standards

