

Data sheet | Item number: 2604-3105

PCB terminal block; operating lever; 4 mm²; Pin spacing 5 mm; 5-pole; Push-in CAGE CLAMP®

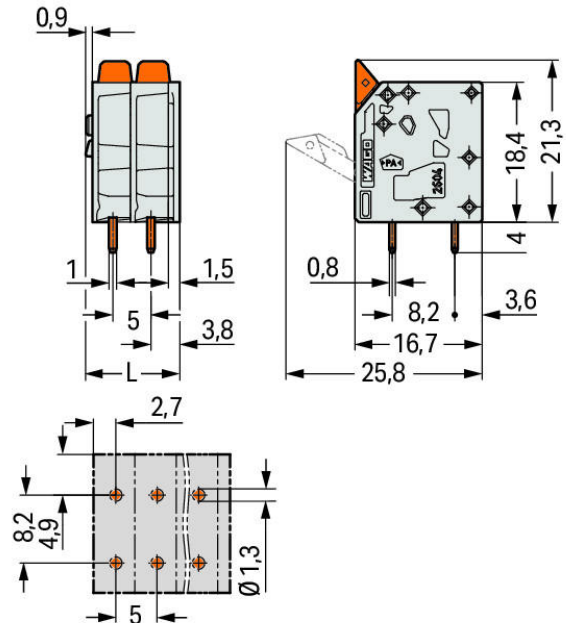

www.wago.com/2604-3105



$L = (\text{pole no.} - 1) \times \text{pin spacing} + 7.4 \text{ mm}$

Item description

- PCB terminal blocks with lever-actuated Push-in CAGE CLAMP® connection
- Push-in termination of solid and ferruled conductors
- Intuitive and tool-free operation
- Several clamping units can be held open simultaneously – convenient for terminating multi-core cables
- Testing can be performed both parallel and perpendicular to conductor entry

Other versions (or variants) can be requested from WAGO Sales or configured at <https://configurator.wago.com/>. Direct marking, Other pole numbers

Data

Electrical data

Ratings per IEC/EN 60664-1

Rated voltage (III / 3)	320 V
Rated impulse voltage (III / 3)	4 kV
Rated voltage (III/2)	400 V
Rated impulse voltage (III / 2)	4 kV
Rated voltage (II / 2)	630 V
Rated impulse voltage (II / 2)	4 kV
Rated current	32 A
Legend (ratings)	(III / 2) $\hat{=}$ Overvoltage category III / Pollution degree 2

Approvals per UL 1059

Rated voltage UL (Use Group B)	300 V
Rated current UL (Use Group B)	20 A
Rated voltage UL (Use Group D)	300 V
Rated current UL (Use Group D)	10 A

Connection data

Connection technology	Push-in CAGE CLAMP®
Actuation type	Lever
Solid conductor	0.2 ... 4 mm ² / 24 ... 12 AWG
Fine-stranded conductor	0.2 ... 4 mm ² / 24 ... 12 AWG
Fine-stranded conductor with ferrule with plastic collar	0.25 ... 2.5 mm ²
Fine-stranded conductor with ferrule without plastic collar	0.25 ... 2.5 mm ²
Fine-stranded conductor, with twin ferrule	0.25 ... 1.5 mm ²
Strip length	9 ... 11 mm / 0.35 ... 0.43 Inch
Conductor entry angle to the PCB	90°
No. of poles	5
Total number of connection points	5
Total number of potentials	5
Number of connection types	1
Number of levels	1



Geometrical Data

Pin spacing	5 mm (0.197 in)
Width	27.4 mm / 1.079 in
Height	25.3 mm / 0.996 in
Height from the surface	21.3 mm / 0.839 in
Depth	16.7 mm / 0.657 in
Solder pin length	4 mm
Solder pin dimensions	0.8 x 1 mm
Drilled hole diameter (tolerance)	1.3 ^(+0.1) mm

PCB contact

PCB contact	THT
Solder pin arrangement	over the entire terminal strip, in line
Number of solder pins per potential	2

Material Data

Color	gray
Material group	I
Insulating material	Polyamide 66 (PA 66)
Flammability class per UL94	V0
Clamping spring material	Chrome nickel spring steel (CrNi)
Contact material	Electrolytic copper (Ecu)
Contact plating	tin-plated
Actuating element color	orange
Weight	8.51 g

Environmental Requirements

Limit temperature range	-60 ... 105 °C
-------------------------	----------------

Commercial data

Country of origin	DE
GTIN	4055143564748
Customs Tariff No.	85369010000

Country specific Approvals

Logo	Approval	Certificate name
	CB DEKRA Certification B.V.	NL-47057
	CSA DEKRA Certification B.V.	70117145

UL-Approvals

Logo	Approval	Certificate name
	cURus Underwriters Laboratories Inc.	E45172 sec. 71

Subject to changes.