

Hybrid motor starter - ELR H3-I-SC- 24DC/500AC-0,6



2900542

<https://www.phoenixcontact.com/pc/products/2900542>

Please be informed that the data shown in this PDF document is generated from our Online Catalog. Please find the complete data in the user documentation. Our General Terms of Use for Downloads are valid.



Hybrid motor starter for starting 3~ AC motors up to 500 V AC and 0.6 A output current, with 24 V DC control voltage, adjustable overload shutdown, and screw connection.

Your advantages

- 22.5 mm wide
- Low-wear switching
- Space saving
- Reduction in wiring
- Long service life
- Adjustable current for bimetal function
- 3-phase loop bridges

Commercial Data

Item number	2900542
Packing unit	1 pc
Minimum order quantity	1 pc
Product Key	CK7421
Catalog Page	Page 35 (C-5-2019)
GTIN	4046356527675
Weight per Piece (including packing)	288 g
Weight per Piece (excluding packing)	204.1 g
Customs tariff number	85371098
Country of origin	DE

Hybrid motor starter - ELR H3-I-SC- 24DC/500AC-0,6



2900542

<https://www.phoenixcontact.com/pc/products/2900542>

Technical Data

Product properties

Product type	Hybrid motor starter
Operating mode	100% operating factor

Electrical properties

Number of phases	3
Motor starter type	Direct starter
Maximum power dissipation for nominal condition	1.5 W
Switching frequency	≤ 2 Hz (Load-dependent)
Maximum power dissipation	1.5 W
Minimum power dissipation	1.1 W
Coordination type	1

Supply

Rated control circuit supply voltage U_S	24 V DC
Control supply voltage range	19.2 V DC ... 30 V DC
Rated control supply current I_S	40 mA
Protective circuit	Surge protection Reverse polarity protection

Insulation characteristics

Rated insulation voltage	500 V
Rated surge voltage	6 kV
Overvoltage category	III
Degree of pollution	2
Insulation characteristics between the control input and control supply voltage, and auxiliary circuit to the main circuit	Safe isolation (IEC 60947-1) at operating voltage ≤ 300 V AC (e. g., 230/400 V AC, 277/480 V AC) Basic insulation (IEC 60947-1) at operating voltage 300 V AC ... 500 V AC
Isolation characteristics between the control input and control supply voltage to auxiliary circuit	Safe isolation (IEC 60947-1) in the auxiliary circuit ≤ 300 V AC

Input data

Control

Input name	Control input
Rated actuating voltage U_C	24 V DC
Triggering voltage range	19.2 V DC ... 30 V DC
Rated actuating current I_C	5 mA (Input type 1)
Switching threshold	9.6 V ("0" signal) 19.2 V ("1" signal)
Typical turn-off time	< 30 ms
Protective circuit	Reverse polarity protection

Hybrid motor starter - ELR H3-I-SC- 24DC/500AC-0,6



2900542

<https://www.phoenixcontact.com/pc/products/2900542>

Output data

AC output

Rated operating voltage U_e	500 V AC
Operating voltage range	42 V AC ... 550 V AC
Rated operating current I_e	0.6 A (AC-51) 0.6 A (AC-53a)
Mains frequency	50/60 Hz
Load current range	75 mA ... 600 mA (see to derating)
Trigger characteristic in acc. with IEC 60947-4-2	Class 10A
Cooling time	20 min. (for auto reset)
Leakage current	0 mA
Protective circuit	Surge protection

Acknowledge output

Note	Confirmation: floating change-over contact, signal contact
Contact type	1 changeover contact
Switching capacity according to IEC 60947-5-1	3 A (230 V, AC15) 2 A (24 V, DC13)

Connection data

Control circuits

Connection method	Screw connection
Stripping length	8 mm
Screw thread	M3
Conductor cross section solid	0.2 mm ² ... 2.5 mm ²
Conductor cross section flexible	0.2 mm ² ... 2.5 mm ²
Conductor cross section AWG	24 ... 14
Tightening torque	0.5 Nm ... 0.6 Nm 5 lb _F -in. ... 7 lb _F -in.

Load circuit

Connection method	Screw connection
Stripping length	8 mm
Screw thread	M3
Conductor cross section solid	0.2 mm ² ... 2.5 mm ²
Conductor cross section flexible	0.2 mm ² ... 2.5 mm ²
Conductor cross section AWG	24 ... 14
Tightening torque	0.5 Nm ... 0.6 Nm 5 lb _F -in. ... 7 lb _F -in.

LED signaling

Status display	Yellow LED
Operating voltage display	Green LED

Hybrid motor starter - ELR H3-I-SC- 24DC/500AC-0,6



2900542

<https://www.phoenixcontact.com/pc/products/2900542>

Error indication	Red LED
------------------	---------

Dimensions

Width	22.5 mm
Height	107 mm
Depth	114 mm

Material specifications

Flammability rating according to UL 94	V0 (Housing)
--	--------------

Environmental and real-life conditions

Ambient conditions

Degree of protection	IP20
Ambient temperature (operation)	-25 °C ... 70 °C (observe derating)
Ambient temperature (storage/transport)	-40 °C ... 80 °C
Altitude	≤ 2000 m

Approval data

UKCA

Certificate	UKCA-compliant
-------------	----------------

UL approval

Certificate	NLDX.E228652
-------------	--------------

UL data

SCCR	100 kA (500 V AC (fuse: 30 A class CC/30 A class J (high fault)))
	5 kA (500 V AC (fuse: 20 A RK5 (standard fault)))
FLA	0.6 A (500 V AC)
Group installation	20 A (class RK5, SCCR 5kA, #24 - 14 AWG max. solid and stranded)
	30 A (class CC or J, SCCR 100kA, #24 - 14 AWG max, solid and stranded)
Category code	NLDX / NRNT

Standards and regulations

Standards/regulations

Standards/regulations	IEC 60947-1
	IEC 60947-4-2
	IEC 61508
	ISO 13849

Mounting

Mounting type	DIN rail mounting
Assembly instructions	alignable, for spacing see derating
Mounting position	vertical (horizontal DIN rail, motor output below)

Hybrid motor starter - ELR H3-I-SC- 24DC/500AC-0,6



2900542

<https://www.phoenixcontact.com/pc/products/2900542>

Drawings

Circuit diagram

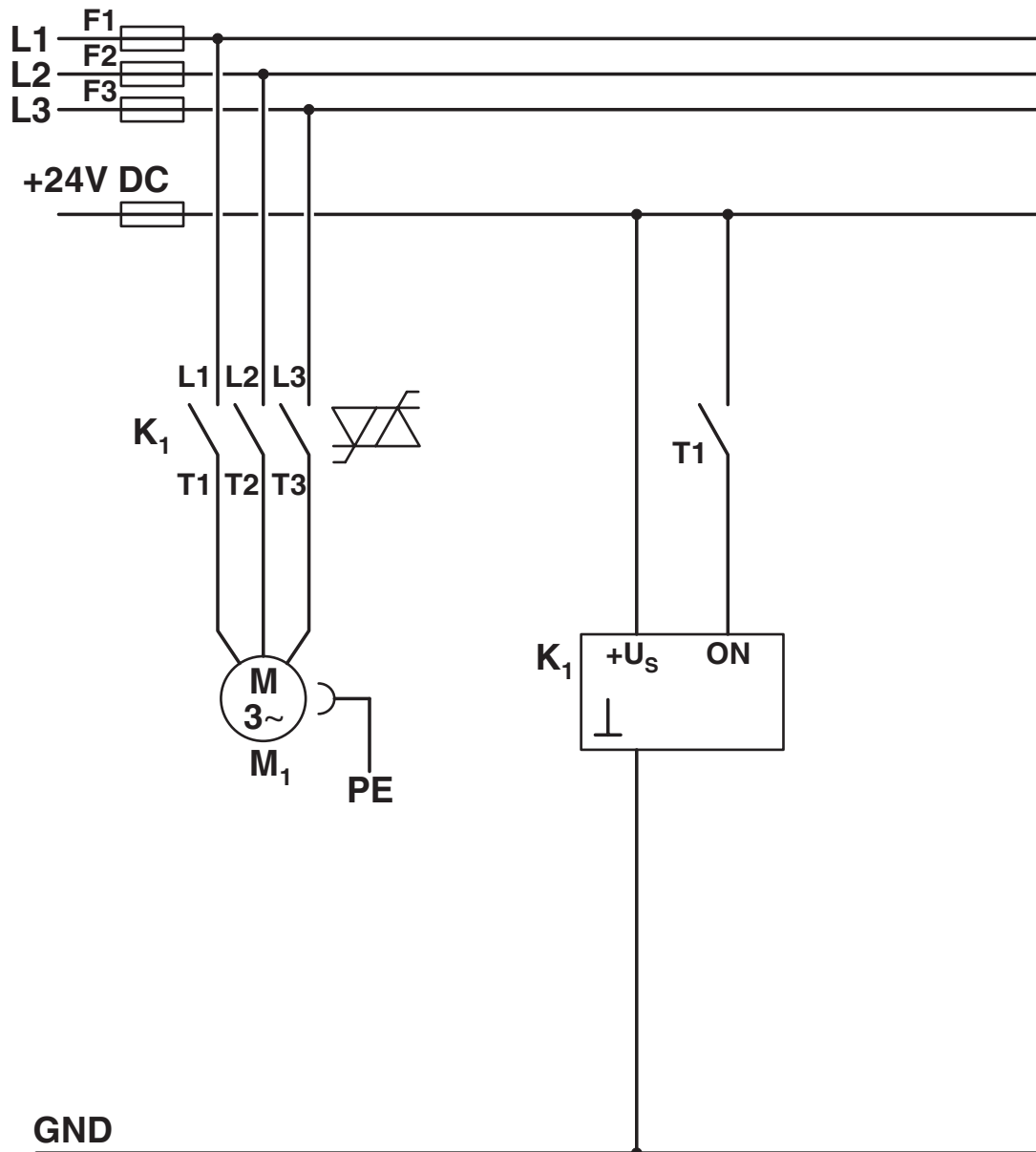

2900542

<https://www.phoenixcontact.com/pc/products/2900542>

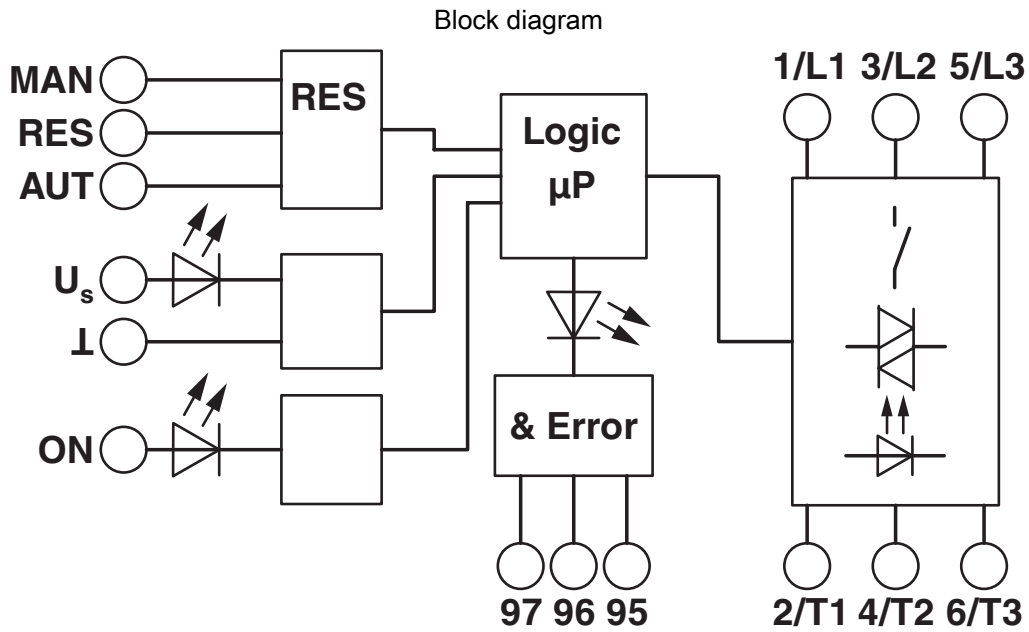

Hybrid motor starter - ELR H3-I-SC- 24DC/500AC-0,6

2900542

<https://www.phoenixcontact.com/pc/products/2900542>



Circuit diagram

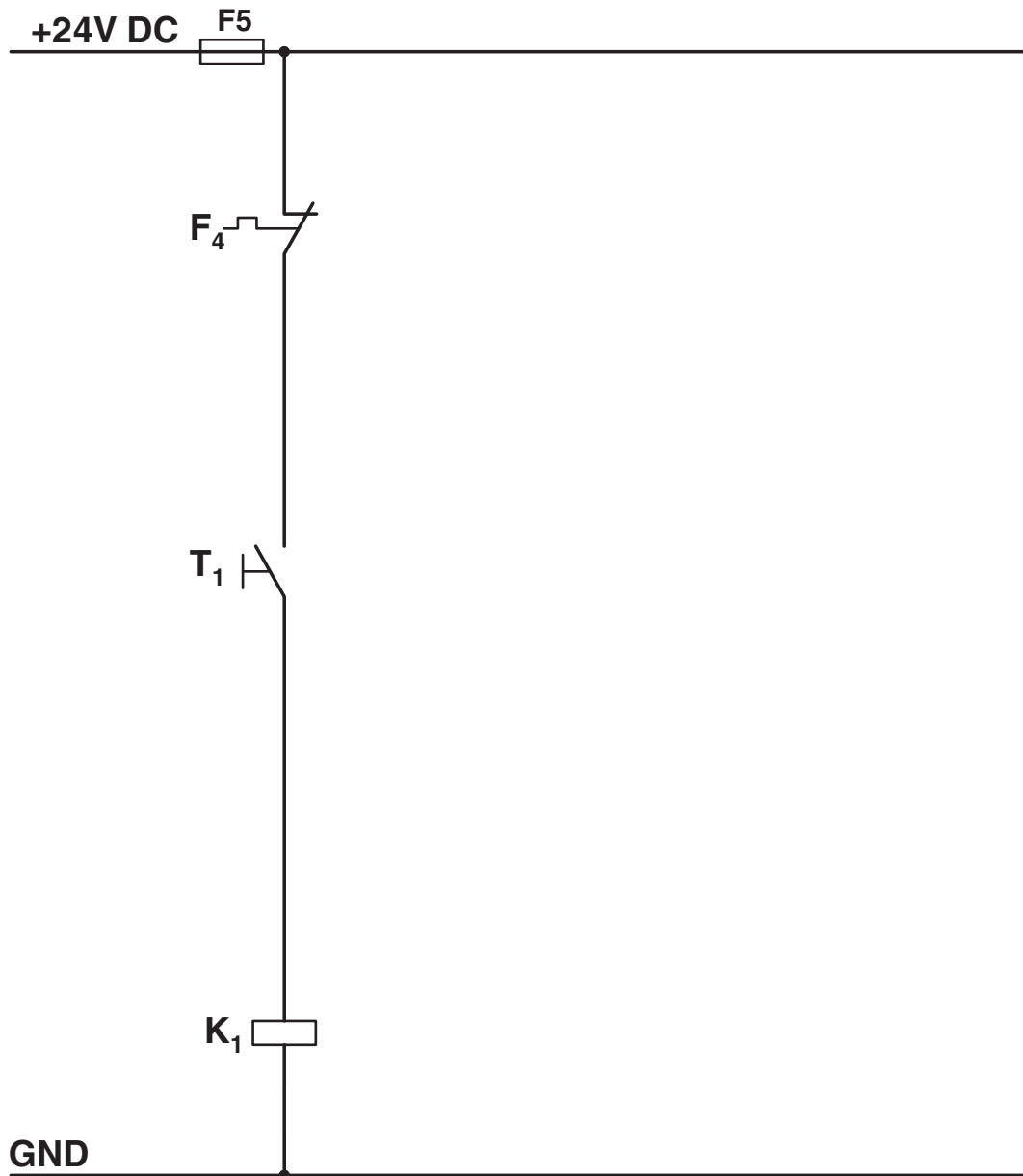

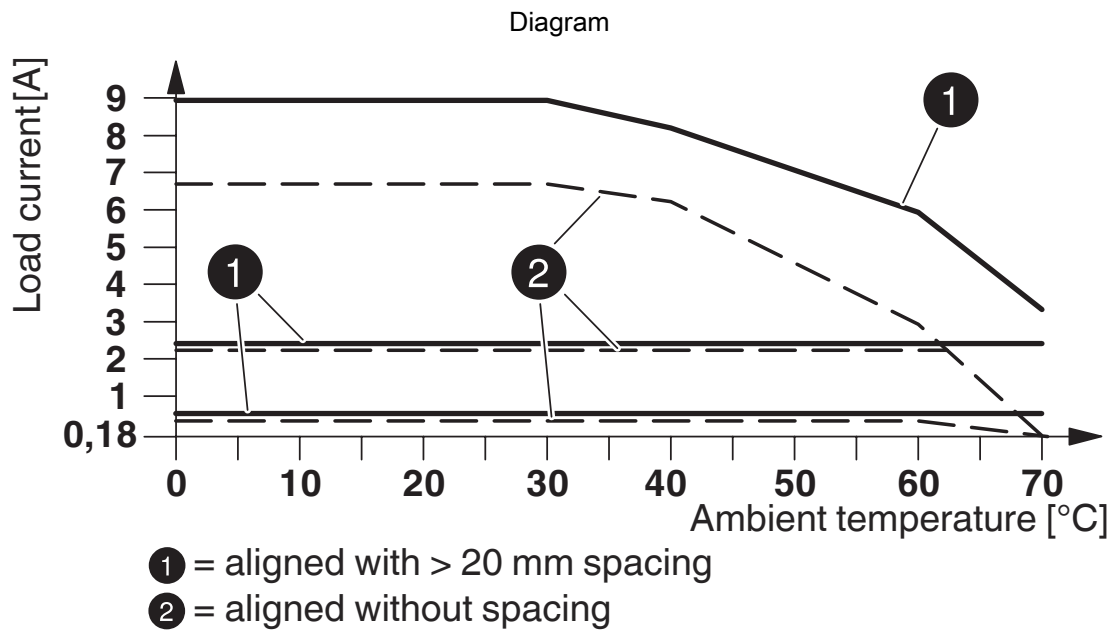

Derating diagram

Hybrid motor starter - ELR H3-I-SC- 24DC/500AC-0,6

2900542

<https://www.phoenixcontact.com/pc/products/2900542>

Circuit diagram

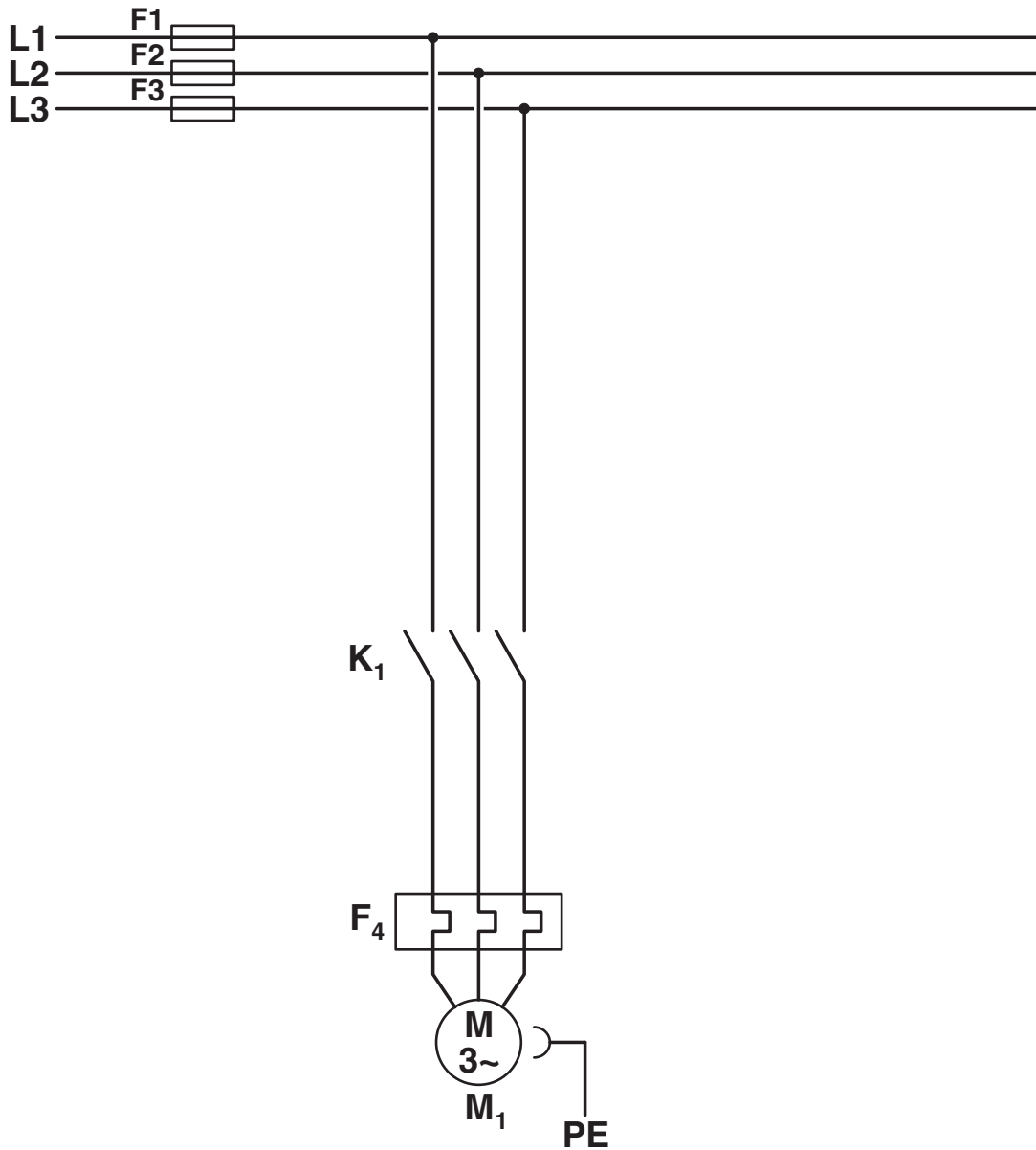

Hybrid motor starter - ELR H3-I-SC- 24DC/500AC-0,6



2900542

<https://www.phoenixcontact.com/pc/products/2900542>

Approvals



IECEE CB Scheme
Approval ID: DE1-55728



EAC
Approval ID: RU*C-DE.*08.B.00520*



UL Listed
Approval ID: FILE E 323771



CCC
Approval ID: 2016010304871315



cUL Listed
Approval ID: FILE E 323771



cUL Listed
Approval ID: FILE E 228652



UL Listed
Approval ID: FILE E 228652

Hybrid motor starter - ELR H3-I-SC- 24DC/500AC-0,6



2900542

<https://www.phoenixcontact.com/pc/products/2900542>

Classifications

ECLASS

ECLASS-9.0	27370905
ECLASS-10.0.1	27370905
ECLASS-11.0	27370905

ETIM

ETIM 8.0	EC001037
----------	----------

UNSPSC

UNSPSC 21.0	25173900
-------------	----------

Hybrid motor starter - ELR H3-I-SC- 24DC/500AC-0,6



2900542

<https://www.phoenixcontact.com/pc/products/2900542>

Environmental Product Compliance

REACH SVHC	Lead 7439-92-1
China RoHS	Environmentally Friendly Use Period = 50 years
	For information on hazardous substances, refer to the manufacturer's declaration available under "Downloads"

Hybrid motor starter - ELR H3-I-SC- 24DC/500AC-0,6



2900542

<https://www.phoenixcontact.com/pc/products/2900542>

Accessories

Plastic label

Plastic label - US-EMLP (15X5) - 0828790

<https://www.phoenixcontact.com/pc/products/0828790>



Plastic label, Card, white, unlabeled, can be labeled with: BLUEMARK ID COLOR, BLUEMARK ID, THERMOMARK PRIME, THERMOMARK CARD 2.0, THERMOMARK CARD, mounting type: adhesive, lettering field size: 15 x 5 mm, Number of individual labels: 189

Plastic label

Plastic label - UC-EMLP (15X5) - 0819301

<https://www.phoenixcontact.com/pc/products/0819301>



Plastic label, Sheet, white, unlabeled, can be labeled with: BLUEMARK ID COLOR, BLUEMARK ID, BLUEMARK CLED, PLOTMARK, CMS-P1-PLOTTER, mounting type: adhesive, lettering field size: 15 x 5 mm, Number of individual labels: 10

Hybrid motor starter - ELR H3-I-SC- 24DC/500AC-0,6



2900542

<https://www.phoenixcontact.com/pc/products/2900542>

Power distribution board

Power distribution board - EM-CPS-225 - 1002634

<https://www.phoenixcontact.com/pc/products/1002634>

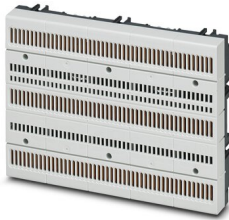

Modular power distribution board with CrossLink® interface, 125 A, 3-pos., touch-proof and protection against polarity reversal, width: 225 mm

Power distribution board

Power distribution board - EM-CPS-405 - 1002635

<https://www.phoenixcontact.com/pc/products/1002635>

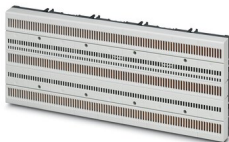

Modular power distribution board with CrossLink® interface, 125 A, 3-pos., touch-proof and protection against polarity reversal, width: 405 mm

Hybrid motor starter - ELR H3-I-SC- 24DC/500AC-0,6



2900542

<https://www.phoenixcontact.com/pc/products/2900542>

Connection module

Connection module - EM-CPS-TB3/63A - 1002633

<https://www.phoenixcontact.com/pc/products/1002633>



Connection module with integrated spring-loaded terminals for cables from 1.5 to 16 mm², 3-pos., maximum 63 A

Adapter

Adapter - EM-CPS-DA-22,5F/16A - 1002668

<https://www.phoenixcontact.com/pc/products/1002668>



Device adapter with fuse holder for 16 A fuse (10x38/Class CC), CrossLink[®] interface and fixed DIN rail

Hybrid motor starter - ELR H3-I-SC- 24DC/500AC-0,6



2900542

<https://www.phoenixcontact.com/pc/products/2900542>

Bridge

Bridge - BRIDGE- 2 - 2900746

<https://www.phoenixcontact.com/pc/products/2900746>

3-phase loop bridge for CONTACTRON modules, with screw connection and 22.5 mm housing width, connecting cable: 0.3 m, with ferrules.



Bridge

Bridge - BRIDGE- 3 - 2900747

<https://www.phoenixcontact.com/pc/products/2900747>

3-phase loop bridge for 3 CONTACTRON modules, with screw connection and 22.5 mm housing width, connecting cable: 0.3 m, with ferrules.



Hybrid motor starter - ELR H3-I-SC- 24DC/500AC-0,6



2900542

<https://www.phoenixcontact.com/pc/products/2900542>

Bridge

Bridge - BRIDGE- 4 - 2900748

<https://www.phoenixcontact.com/pc/products/2900748>

3-phase loop bridge for 4 CONTACTRON modules, with screw connection and 22.5 mm housing width, connecting cable: 0.3 m, with ferrules.



Bridge

Bridge - BRIDGE- 5 - 2900749

<https://www.phoenixcontact.com/pc/products/2900749>

3-phase loop bridge for 5 CONTACTRON modules, with screw connection and 22.5 mm housing width, connecting cable: 0.3 m, with ferrules.



Hybrid motor starter - ELR H3-I-SC- 24DC/500AC-0,6



2900542

<https://www.phoenixcontact.com/pc/products/2900542>

Bridge

Bridge - BRIDGE- 6 - 2900750

<https://www.phoenixcontact.com/pc/products/2900750>

3-phase loop bridge for 6 CONTACTRON modules, with screw connection and 22.5 mm housing width, connecting cable: 0.3 m, with ferrules.



Bridge

Bridge - BRIDGE- 7 - 2900751

<https://www.phoenixcontact.com/pc/products/2900751>

3-phase loop bridge for 7 CONTACTRON modules, with screw connection and 22.5 mm housing width, connecting cable: 0.3 m, with ferrules.



Hybrid motor starter - ELR H3-I-SC- 24DC/500AC-0,6



2900542

<https://www.phoenixcontact.com/pc/products/2900542>

Bridge

Bridge - BRIDGE- 8 - 2900752

<https://www.phoenixcontact.com/pc/products/2900752>

3-phase loop bridge for 8 CONTACTRON modules, with screw connection and 22.5 mm housing width, connecting cable: 0.3 m, with ferrules.



Bridge

Bridge - BRIDGE- 9 - 2900753

<https://www.phoenixcontact.com/pc/products/2900753>

3-phase loop bridge for 9 CONTACTRON modules, with screw connection and 22.5 mm housing width, connecting cable: 0.3 m, with ferrules.



Hybrid motor starter - ELR H3-I-SC- 24DC/500AC-0,6



2900542

<https://www.phoenixcontact.com/pc/products/2900542>

Bridge

Bridge - BRIDGE-10 - 2900754

<https://www.phoenixcontact.com/pc/products/2900754>

3-phase loop bridge for 10 CONTACTRON modules, with screw connection and 22.5 mm housing width, connecting cable: 0.3 m, with ferrules.



Bridge

Bridge - BRIDGE- 2-1M - 2901542

<https://www.phoenixcontact.com/pc/products/2901542>

3-phase loop bridge for 2 CONTACTRON modules, with screw connection and 22.5 mm housing width, connecting cable: 1 m



Hybrid motor starter - ELR H3-I-SC- 24DC/500AC-0,6



2900542

<https://www.phoenixcontact.com/pc/products/2900542>

Bridge

Bridge - BRIDGE- 3-1M - 2901655

<https://www.phoenixcontact.com/pc/products/2901655>

3-phase loop bridge for 3 CONTACTRON modules, with screw connection and 22.5 mm housing width, connecting cable: 1 m



Bridge

Bridge - BRIDGE- 4-1M - 2901658

<https://www.phoenixcontact.com/pc/products/2901658>

3-phase loop bridge for 4 CONTACTRON modules, with screw connection and 22.5 mm housing width, connecting cable: 1 m



Hybrid motor starter - ELR H3-I-SC- 24DC/500AC-0,6



2900542

<https://www.phoenixcontact.com/pc/products/2900542>

Bridge

Bridge - BRIDGE- 5-1M - 2901544

<https://www.phoenixcontact.com/pc/products/2901544>

3-phase loop bridge for 5 CONTACTRON modules, with screw connection and 22.5 mm housing width, connecting cable: 1 m



Bridge

Bridge - BRIDGE- 6-1M - 2901649

<https://www.phoenixcontact.com/pc/products/2901649>

3-phase loop bridge for 6 CONTACTRON modules, with screw connection and 22.5 mm housing width, connecting cable: 1 m



Hybrid motor starter - ELR H3-I-SC- 24DC/500AC-0,6



2900542

<https://www.phoenixcontact.com/pc/products/2900542>

Bridge

Bridge - BRIDGE- 2-3M - 2901543

<https://www.phoenixcontact.com/pc/products/2901543>

3-phase loop bridge for 2 CONTACTRON modules, with screw connection and 22.5 mm housing width, connecting cable: 3 m



Bridge

Bridge - BRIDGE- 3-3M - 2901656

<https://www.phoenixcontact.com/pc/products/2901656>

3-phase loop bridge for 3 CONTACTRON modules, with screw connection and 22.5 mm housing width, connecting cable: 3 m



Hybrid motor starter - ELR H3-I-SC- 24DC/500AC-0,6



2900542

<https://www.phoenixcontact.com/pc/products/2900542>

Bridge

Bridge - BRIDGE- 4-3M - 2901659

<https://www.phoenixcontact.com/pc/products/2901659>

3-phase loop bridge for 4 CONTACTRON modules, with screw connection and 22.5 mm housing width, connecting cable: 3 m



Bridge

Bridge - BRIDGE- 5-3M - 2901545

<https://www.phoenixcontact.com/pc/products/2901545>

3-phase loop bridge for 5 CONTACTRON modules, with screw connection and 22.5 mm housing width, connecting cable: 3 m



Hybrid motor starter - ELR H3-I-SC- 24DC/500AC-0,6



2900542

<https://www.phoenixcontact.com/pc/products/2900542>

Bridge

Bridge - BRIDGE- 6-3M - 2901697

<https://www.phoenixcontact.com/pc/products/2901697>

3-phase loop bridge for 6 CONTACTRON modules, with screw connection and 22.5 mm housing width, connecting cable: 3 m



Bridge

Bridge - BRIDGE- 7-3M - 2901698

<https://www.phoenixcontact.com/pc/products/2901698>

3-phase loop bridge for 7 CONTACTRON modules, with screw connection and 22.5 mm housing width, connecting cable: 3 m



Hybrid motor starter - ELR H3-I-SC- 24DC/500AC-0,6



2900542

<https://www.phoenixcontact.com/pc/products/2900542>

Bridge

Bridge - BRIDGE- 8-3M - 2901700

<https://www.phoenixcontact.com/pc/products/2901700>

3-phase loop bridge for 8 CONTACTRON modules, with screw connection and 22.5 mm housing width, connecting cable: 3 m



Bridge

Bridge - BRIDGE- 9-3M - 2901701

<https://www.phoenixcontact.com/pc/products/2901701>

3-phase loop bridge for 9 CONTACTRON modules, with screw connection and 22.5 mm housing width, connecting cable: 3 m



Hybrid motor starter - ELR H3-I-SC- 24DC/500AC-0,6



2900542

<https://www.phoenixcontact.com/pc/products/2900542>

Bridge

Bridge - BRIDGE-10-3M - 2901702

<https://www.phoenixcontact.com/pc/products/2901702>

3-phase loop bridge for 10 CONTACTRON modules, with screw connection and 22.5 mm housing width, connecting cable: 3 m



Bridge

Bridge - BRIDGE- 2- 2M/0,3M - 2909897

<https://www.phoenixcontact.com/pc/products/2909897>

3-phase loop bridge for 2 CONTACTRON modules, with screw connection and 22.5 mm housing width, cable length between the modules: 0.3 m, connecting cable: 2 m



Hybrid motor starter - ELR H3-I-SC- 24DC/500AC-0,6



2900542

<https://www.phoenixcontact.com/pc/products/2900542>

Bridge

Bridge - BRIDGE- 3- 2M/0,3M - 2909898

<https://www.phoenixcontact.com/pc/products/2909898>



3-phase loop bridge for 3 CONTACTRON modules, with screw connection and 22.5 mm housing width, cable length between the modules: 0.3 m, connecting cable: 2 m

Bridge

Bridge - BRIDGE- 4- 2M/0,3M - 2909899

<https://www.phoenixcontact.com/pc/products/2909899>



3-phase loop bridge for 4 CONTACTRON modules, with screw connection and 22.5 mm housing width, cable length between the modules: 0.3 m, connecting cable: 2 m

Hybrid motor starter - ELR H3-I-SC- 24DC/500AC-0,6



2900542

<https://www.phoenixcontact.com/pc/products/2900542>

Covering hood

Covering hood - BRIDGE COVER - 2906240

<https://www.phoenixcontact.com/pc/products/2906240>

The BRIDGE COVER covering hood is used to cover unused plugs on the CONTACTRON bridge that may subsequently be used to extend the system. The hood can be used with the screw and Push-in version of the bridge.



Phoenix Contact 2022 © - all rights reserved

<https://www.phoenixcontact.com>

PHOENIX CONTACT GmbH & Co. KG

Flachsmarktstraße 8

D-32825 Blomberg

+49 (0) 5235-3 00

info@phoenixcontact.com