

# PTPOWER 50 - High-current terminal block



3260050

<https://www.phoenixcontact.com/pc/products/3260050>

Please be informed that the data shown in this PDF document is generated from our online catalog. Please find the complete data in the user documentation. Our general terms of use for downloads are valid.



High-current terminal block, nom. voltage: 1000 V, nominal current: 150 A, number of connections: 2, number of positions: 1, connection method: PowerTurn connection, 1 level, cross section: 10 mm<sup>2</sup> - 70 mm<sup>2</sup>, mounting type: NS 35/15, color: gray

## Your advantages

- Quick and easy connection is now also possible for large conductors with the high-current terminal block
- The compact design enables wiring in a confined space
- The Push-in connection terminal blocks are characterized by the system features of the CLIPLINE complete system and by easy and tool-free wiring of conductors with ferrules or solid conductors
- In addition to using the existing test pick-off, pick-off terminal blocks can be connected, each of which can also accommodate two test cables

## Commercial data

Item number	3260050
Packing unit	10 pc
Minimum order quantity	1 pc
Product key	BE2211
Catalog page	Page 137 (C-1-2019)
GTIN	4046356998000
Weight per piece (including packing)	156.92 g
Weight per piece (excluding packing)	152 g
Customs tariff number	85369010
Country of origin	PL

# PTPOWER 50 - High-current terminal block



3260050

<https://www.phoenixcontact.com/pc/products/3260050>

## Technical data

### Product properties

Product type	High current terminal block
Number of positions	1
Number of connections	2
Number of rows	1
Potentials	1

### Insulation characteristics

Overvoltage category	III
Degree of pollution	3

### Electrical properties

Rated surge voltage	8 kV
Maximum power dissipation for nominal condition	4.73 W

### Connection data

Number of connections per level	2
Nominal cross section	50 mm <sup>2</sup>
Rated cross section AWG	2/0

#### 1 level

Stripping length	30 mm ... 32 mm
Internal cylindrical gage	A10
Connection in acc. with standard	IEC 60947-7-1
Conductor cross section rigid	10 mm <sup>2</sup> ... 70 mm <sup>2</sup>
Cross section AWG	6 ... 2/0 (converted acc. to IEC)
Conductor cross section flexible	10 mm <sup>2</sup> ... 70 mm <sup>2</sup>
Conductor cross section, flexible [AWG]	6 ... 2/0 (converted acc. to IEC)
Conductor cross-section flexible (ferrule without plastic sleeve)	10 mm <sup>2</sup> ... 50 mm <sup>2</sup>
Flexible conductor cross section (ferrule with plastic sleeve)	10 mm <sup>2</sup> ... 50 mm <sup>2</sup>
Cross-section with insertion bridge, rigid	10 mm <sup>2</sup> ... 50 mm <sup>2</sup>
Cross-section with insertion bridge, flexible	10 mm <sup>2</sup> ... 50 mm <sup>2</sup>
Cross-section with insertion bridge, flexible, with ferrule without plastic sleeve	10 mm <sup>2</sup> ... 50 mm <sup>2</sup>
Cross-section with insertion bridge, flexible, with ferrule with plastic sleeve	10 mm <sup>2</sup> ... 50 mm <sup>2</sup>
Nominal current	150 A
Maximum load current	150 A (with 70 mm <sup>2</sup> conductor cross section)
Nominal voltage	1000 V

#### 1 level Connection cross sections directly pluggable

Conductor cross section rigid	10 mm <sup>2</sup> ... 70 mm <sup>2</sup>
Conductor cross section, rigid [AWG]	8 ... 2/0 (converted acc. to IEC)

# PTPOWER 50 - High-current terminal block



3260050

<https://www.phoenixcontact.com/pc/products/3260050>

Conductor cross-section flexible (ferrule without plastic sleeve)	10 mm <sup>2</sup> ... 50 mm <sup>2</sup>
Flexible conductor cross section (ferrule with plastic sleeve)	10 mm <sup>2</sup> ... 50 mm <sup>2</sup>

## Ex data

### Rated data (ATEX/IECEX)

Identification	⊕ II 2 GD Ex eb IIC Gb
Operating temperature range	-60 °C ... 110 °C
Ex-certified accessories	1206612 SZF 3-1,0X5,5 1201662 E/AL-NS 35
List of bridges	/ EB 2-20/PT / 3260067 / EB 3-20/PT / 3260068
Bridge data	131 A / 50 mm <sup>2</sup>
Ex temperature increase	40 K (147 A / 50 mm <sup>2</sup> )
Rated voltage	1100 V
at bridging with insertion bridge	1100 V
Rated insulation voltage	1000 V
output	(Permanent)

### Ex level General

Rated current	134 A
Maximum load current	134 A
Contact resistance	0.16 mΩ

### Ex connection data General

Ferrule length	30 mm ... 32 mm
Stripping length	30 mm
Nominal cross section	50 mm <sup>2</sup>
Rated cross section AWG	1/0
Connection capacity rigid	10 mm <sup>2</sup> ... 70 mm <sup>2</sup>
Connection capacity AWG	8 ... 2/0
Conductor cross section flexible, with ferrule without plastic sleeve min.	16 mm <sup>2</sup>
Conductor cross section flexible, with ferrule without plastic sleeve max.	50 mm <sup>2</sup>

## Dimensions

Width	20 mm
Height	101 mm
Depth on NS 35/15	105 mm

## Material specifications

Color	gray
Flammability rating according to UL 94	V0
Insulating material group	I
Insulating material	PA

# PTPOWER 50 - High-current terminal block



3260050

<https://www.phoenixcontact.com/pc/products/3260050>

Static insulating material application in cold	-60 °C
Temperature index of insulation material (DIN EN 60216-1 (VDE 0304-21))	125 °C
Relative insulation material temperature index (Elec., UL 746 B)	130 °C
Fire protection for rail vehicles (DIN EN 45545-2) R22	HL 1 - HL 3
Fire protection for rail vehicles (DIN EN 45545-2) R23	HL 1 - HL 3
Fire protection for rail vehicles (DIN EN 45545-2) R24	HL 1 - HL 3
Fire protection for rail vehicles (DIN EN 45545-2) R26	HL 1 - HL 3
Calorimetric heat release NFPA 130 (ASTM E 1354)	27,5 MJ/kg
Surface flammability NFPA 130 (ASTM E 162)	passed
Specific optical density of smoke NFPA 130 (ASTM E 662)	passed
Smoke gas toxicity NFPA 130 (SMP 800C)	passed

## Electrical tests

### Surge voltage test

Test voltage setpoint	9.8 kV
Result	Test passed

### Temperature-rise test

Requirement temperature-rise test	Increase in temperature $\leq$ 45 K
Result	Test passed
Short-time withstand current 50 mm <sup>2</sup>	6 kA
Result	Test passed

### Power-frequency withstand voltage

Result	Test passed
--------	-------------

## Mechanical properties

### Mechanical data

Open side panel	No
-----------------	----

## Mechanical tests

### Mechanical strength

Result	Test passed
--------	-------------

### Attachment on the carrier

DIN rail/fixing support	NS 35
Test force setpoint	10 N
Result	Test passed

### Test for conductor damage and slackening

Rotation speed	10 rpm
Revolutions	135
Conductor cross section/weight	10 mm <sup>2</sup> / 2 kg 50 mm <sup>2</sup> / 9.5 kg

# PTPOWER 50 - High-current terminal block



3260050

<https://www.phoenixcontact.com/pc/products/3260050>

	70 mm <sup>2</sup> /10.4 kg
Result	Test passed

## Environmental and real-life conditions

### Aging

Temperature cycles	192
Result	Test passed

### Needle-flame test

Time of exposure	30 s
Result	Test passed

### Oscillation/broadband noise

Specification	DIN EN 50155 (VDE 0115-200):2008-03
Spectrum	Service life test category 2, bogie-mounted
Frequency	$f_1 = 5 \text{ Hz}$ to $f_2 = 250 \text{ Hz}$
ASD level	6.12 (m/s <sup>2</sup> ) <sup>2</sup> /Hz
Acceleration	3.12g
Test duration per axis	5 h
Test directions	X-, Y- and Z-axis
Result	Test passed

### Shocks

Specification	DIN EN 50155 (VDE 0115-200):2008-03
Pulse shape	Half-sine
Acceleration	30g
Shock duration	18 ms
Number of shocks per direction	3
Test directions	X-, Y- and Z-axis (pos. and neg.)
Result	Test passed

### Ambient conditions

Ambient temperature (operation)	-60 °C ... 110 °C (Operating temperature range incl. self-heating; for max. short-term operating temperature, see RTI Elec.)
Ambient temperature (storage/transport)	-25 °C ... 60 °C (for a short time, no longer than 24 h, -60°C to +70°C)
Ambient temperature (assembly)	-5 °C ... 70 °C
Ambient temperature (actuation)	-5 °C ... 70 °C
Permissible humidity (operation)	20 % ... 90 %
Permissible humidity (storage/transport)	30 % ... 70 %

## Standards and regulations

Connection in acc. with standard	IEC 60947-7-1
----------------------------------	---------------

## Mounting

Mounting type	NS 35/15
---------------	----------

# PTPOWER 50 - High-current terminal block

3260050

<https://www.phoenixcontact.com/pc/products/3260050>

## Drawings

Schematic diagram

### PTPOWER

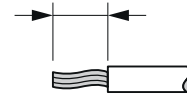

AGK 10-PTPOWER	0,5 mm <sup>2</sup> ... 16 mm <sup>2</sup>	18 mm
PTPOWER 35	2,5 mm <sup>2</sup> ... 35 mm <sup>2</sup>	25 mm
PTPOWER 50	10 mm <sup>2</sup> ... 50 mm <sup>2</sup>	32 mm
PTPOWER 95	25 mm <sup>2</sup> ... 95 mm <sup>2</sup>	40 mm
PTPOWER 185	95 mm <sup>2</sup> ... 185 mm <sup>2</sup>	40 mm

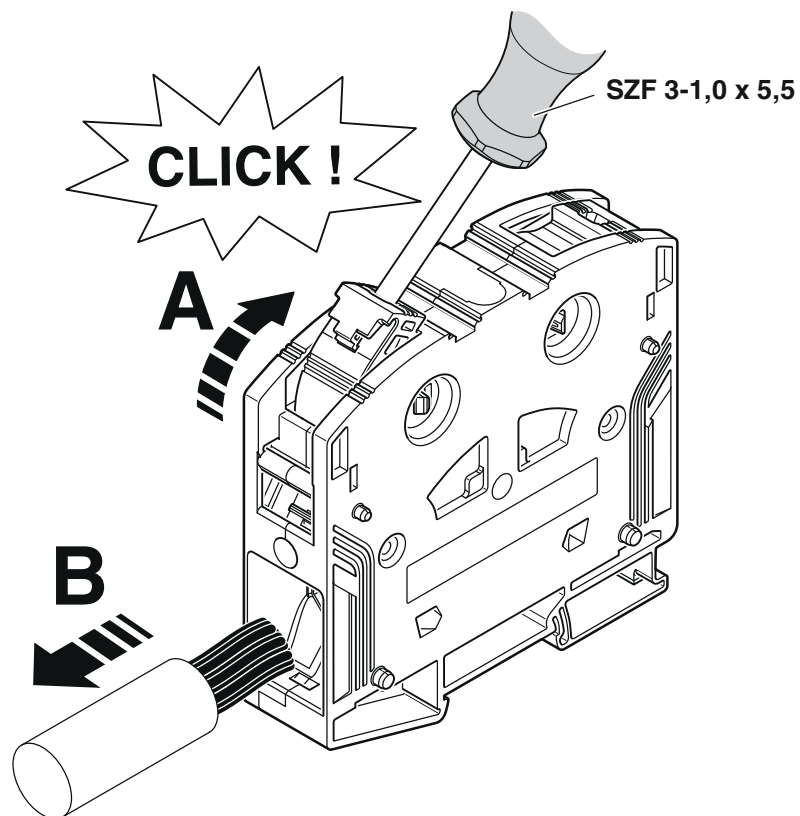

# PPOWER 50 - High-current terminal block



3260050

<https://www.phoenixcontact.com/pc/products/3260050>

Circuit diagram



# PTPOWER 50 - High-current terminal block



3260050

<https://www.phoenixcontact.com/pc/products/3260050>

## Approvals

To download certificates, visit the product detail page: <https://www.phoenixcontact.com/pc/products/3260050>

 **CSA**  
Approval ID: 13631

 **cUL Recognized**  
Approval ID: E60425

	Nominal voltage $U_N$	Nominal current $I_N$	Cross section AWG	Cross section $\text{mm}^2$
Use group C				
	1000 V	140 A	8 - 1/0	-

 **UL Recognized**  
Approval ID: E60425

	Nominal voltage $U_N$	Nominal current $I_N$	Cross section AWG	Cross section $\text{mm}^2$
Use group E				
	1000 V	140 A	8 - 1/0	-

**DNV**  
Approval ID: TAE00000Z9

 **CSA**  
Approval ID: 13631

 **CCC**  
Approval ID: 2020322313000630

 **UKCA-EX**  
Approval ID: CML 22UKEX1227U

 **IECEx**  
Approval ID: IECExSEV14.0013U

 **ATEX**  
Approval ID: SEV14ATEX0156U

	Nominal voltage $U_N$	Nominal current $I_N$	Cross section AWG	Cross section $\text{mm}^2$
Only rigid conductors	1100 V	134 A	-	10 - 70
multi-stranded with	1100 V	134 A	-	16 - 50



# PTPOWER 50 - High-current terminal block



3260050

<https://www.phoenixcontact.com/pc/products/3260050>

ferrule



**IECEX**

Approval ID: IECExSEV14.0013U

	Nominal voltage $U_N$	Nominal current $I_N$	Cross section AWG	Cross section $\text{mm}^2$
	1100 V	134 A	-	-
Only rigid conductors	1100 V	134 A	-	-
multi-stranded with ferrule	1100 V	134 A	-	-

**cULus Recognized**

# PTPOWER 50 - High-current terminal block



3260050

<https://www.phoenixcontact.com/pc/products/3260050>

## Classifications

### ECLASS

ECLASS-11.0	27141120
ECLASS-13.0	27250101

### ETIM

ETIM 9.0	EC000897
----------	----------

### UNSPSC

UNSPSC 21.0	39121400
-------------	----------

# PTPOWER 50 - High-current terminal block



3260050

<https://www.phoenixcontact.com/pc/products/3260050>

## Environmental product compliance

China RoHS	Environmentally friendly use period: unlimited = EFUP-e
	No hazardous substances above threshold values

# PTPOWER 50 - High-current terminal block

3260050

<https://www.phoenixcontact.com/pc/products/3260050>

## Accessories

 Note: Applying some accessories below might limit this product.

### EB 2-20/PT - Insertion bridge

3260067

<https://www.phoenixcontact.com/pc/products/3260067>

Insertion bridge, pitch: 20 mm, number of positions: 2, length: 65 mm, color: red



 Max. current carrying capacity: 150 A

---

### EB 3-20/PT - Insertion bridge

3260068

<https://www.phoenixcontact.com/pc/products/3260068>

Insertion bridge, pitch: 20 mm, number of positions: 3, length: 65 mm, color: red

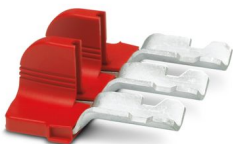

 Max. current carrying capacity: 150 A

# PTPOWER 50 - High-current terminal block



3260050

<https://www.phoenixcontact.com/pc/products/3260050>

## AGK 10-PTPOWER - Pick-off terminal block

3260145

<https://www.phoenixcontact.com/pc/products/3260145>



Pick-off terminal block, nom. voltage: 1500 V, nominal current: 57 A, number of connections: 2, connection method: Push-in connection, 1 level, Rated cross section: 10 mm<sup>2</sup>, cross section: 0.5 mm<sup>2</sup> - 16 mm<sup>2</sup>, mounting type: on base element, color: gray

---

## AGK 10-PTPOWER BU - Pick-off terminal block

3260148

<https://www.phoenixcontact.com/pc/products/3260148>



Pick-off terminal block, nom. voltage: 1500 V, nominal current: 57 A, number of connections: 2, connection method: Push-in connection, 1 level, Rated cross section: 10 mm<sup>2</sup>, cross section: 0.5 mm<sup>2</sup> - 16 mm<sup>2</sup>, mounting type: on base element, color: blue

# PTPOWER 50 - High-current terminal block

3260050

<https://www.phoenixcontact.com/pc/products/3260050>

## AGK 10-PTPOWER GN/YE - Pick-off terminal block

3260151

<https://www.phoenixcontact.com/pc/products/3260151>



Pick-off terminal block, nom. voltage: 1500 V, nominal current: 57 A, number of connections: 2, connection method: Push-in connection, 1 level, Rated cross section: 10 mm<sup>2</sup>, cross section: 0.5 mm<sup>2</sup> - 16 mm<sup>2</sup>, mounting type: on base element, color: green/yellow

---

## AGK 10-PTPOWER BK/YE - Pick-off terminal block

3260154

<https://www.phoenixcontact.com/pc/products/3260154>



Pick-off terminal block, nom. voltage: 1500 V, nominal current: 57 A, number of connections: 2, connection method: Push-in connection, 1 level, Rated cross section: 10 mm<sup>2</sup>, cross section: 0.5 mm<sup>2</sup> - 16 mm<sup>2</sup>, mounting type: on base element, color: black/yellow

# PTPOWER 50 - High-current terminal block



3260050

<https://www.phoenixcontact.com/pc/products/3260050>

## NS 35/15 PERF 2000MM - DIN rail perforated

1201730

<https://www.phoenixcontact.com/pc/products/1201730>



DIN rail perforated, Pack of 25 (50 m), similar to EN 60715, material: Steel, galvanized, passivated with a thick layer, Standard profile, color: silver

---

## NS 35/15 UNPERF 2000MM - DIN rail, unperforated

1201714

<https://www.phoenixcontact.com/pc/products/1201714>



DIN rail, unperforated, Pack of 25 (50 m), similar to EN 60715, material: Steel, galvanized, passivated with a thick layer, Standard profile, color: silver

# PTPOWER 50 - High-current terminal block



3260050

<https://www.phoenixcontact.com/pc/products/3260050>

## NS 35/15 WH PERF 2000MM - DIN rail perforated

0806602

<https://www.phoenixcontact.com/pc/products/0806602>



DIN rail perforated, Pack of 25 (50 m), similar to EN 60715, material: Steel, Galvanized, white passivated, Standard profile, color: white

---

## NS 35/15 WH UNPERF 2000MM-VPE 10 - DIN rail, unperforated

1204135

<https://www.phoenixcontact.com/pc/products/1204135>



DIN rail, unperforated, Pack of 10 (20 m), similar to EN 60715, material: Steel, Galvanized, white passivated, Standard profile, color: silver



# PTPOWER 50 - High-current terminal block



3260050

<https://www.phoenixcontact.com/pc/products/3260050>

## NS 35/15 AL UNPERF 2000MM - DIN rail, unperforated

1201756

<https://www.phoenixcontact.com/pc/products/1201756>



DIN rail, unperforated, similar to EN 60715, material: Aluminum, uncoated, Standard profile, color: silver

---

## NS 35/15 ZN PERF 2000MM - DIN rail perforated

1206599

<https://www.phoenixcontact.com/pc/products/1206599>



DIN rail perforated, Pack of 25 (50 m), similar to EN 60715, material: Steel, galvanized, Standard profile, color: silver

# PTPOWER 50 - High-current terminal block



3260050

<https://www.phoenixcontact.com/pc/products/3260050>

## NS 35/15 ZN UNPERF 2000MM - DIN rail, unperforated

1206586

<https://www.phoenixcontact.com/pc/products/1206586>



DIN rail, unperforated, Pack of 25 (50 m), similar to EN 60715, material: Steel, galvanized, Standard profile, color: silver

---

## NS 35/15 CU UNPERF 2000MM-VPE 10 - DIN rail, unperforated

1201895

<https://www.phoenixcontact.com/pc/products/1201895>



DIN rail, unperforated, Pack of 10 (20 m), similar to EN 60715, material: Copper, uncoated, Standard profile, color: copper-colored

# PTPOWER 50 - High-current terminal block



3260050

<https://www.phoenixcontact.com/pc/products/3260050>

## NS 35/15 CAP - End cap

1206573

<https://www.phoenixcontact.com/pc/products/1206573>

DIN rail end piece, for DIN rail NS 35/15



---

## TMT 10 R - Marker for terminal blocks

0816210

<https://www.phoenixcontact.com/pc/products/0816210>



Marker for terminal blocks, Roll, white, unlabeled, can be labeled with: THERMOMARK ROLL 2.0, THERMOMARK ROLL, THERMOMARK ROLL X1, THERMOMARK ROLLMASTER 300/600, THERMOMARK X1.2, THERMOMARK S1.1, perforated, mounting type: snapped, snap into flat marker groove, for terminal block width: 10.2 mm, lettering field size: 6.35 x 10.15 mm, Number of individual labels: 10000

# PTPOWER 50 - High-current terminal block



3260050

<https://www.phoenixcontact.com/pc/products/3260050>

## TMT 10 R CUS - Marker for terminal blocks

0824500

<https://www.phoenixcontact.com/pc/products/0824500>



Marker for terminal blocks, can be ordered: by line, white, labeled according to customer specifications, mounting type: snap into universal marker groove, snap into flat marker groove, for terminal block width: 10.2 mm, lettering field size: 6.35 x 10.15 mm

---

## ZB 10:UNBEDRUCKT - Zack marker strip

1053001

<https://www.phoenixcontact.com/pc/products/1053001>



Zack marker strip, Strip, white, unlabeled, can be labeled with: PLOTMARK, CMS-P1-PLOTTER, mounting type: snapped, for terminal block width: 10.2 mm, lettering field size: 10.5 x 10.15 mm, Number of individual labels: 10

# PTPOWER 50 - High-current terminal block

3260050

<https://www.phoenixcontact.com/pc/products/3260050>

## ZB 10 CUS - Zack marker strip

0824941

<https://www.phoenixcontact.com/pc/products/0824941>



Zack marker strip, can be ordered: Strip, white, labeled according to customer specifications, mounting type: snap into tall marker groove, for terminal block width: 10.2 mm, lettering field size: 10,15 x 10,5 mm, Number of individual labels: 10

---

## ZB10,LGS:FORTL.ZAHLEN - Zack marker strip

1053014

<https://www.phoenixcontact.com/pc/products/1053014>



Zack marker strip, Strip, white, labeled, can be labeled with: CMS-P1-PLOTTER, printed horizontally: consecutive numbers 1 ... 10, 11 ... 20, etc. up to 91 ... 100, mounting type: snapped, for terminal block width: 10.2 mm, lettering field size: 10,15 x 10,5 mm, Number of individual labels: 10

# PTPOWER 50 - High-current terminal block



3260050

<https://www.phoenixcontact.com/pc/products/3260050>

## ZB10,QR:FORTL.ZAHLEN - Zack marker strip

1053027

<https://www.phoenixcontact.com/pc/products/1053027>



Zack marker strip, Strip, white, labeled, can be labeled with: CMS-P1-PLOTTER, Printed vertically: consecutive numbers 1 ... 10, 11 ... 20, etc. up to 91 ... 100, mounting type: snapped, for terminal block width: 10.2 mm, lettering field size: 10,15 x 10,5 mm, Number of individual labels: 10

---

## ZB10,LGS:L1-N,PE - Marker for terminal blocks

1053412

<https://www.phoenixcontact.com/pc/products/1053412>



Marker for terminal blocks, Strip, white, labeled, can be labeled with: CMS-P1-PLOTTER, horizontal: L1, L2, L3, N, PE, L1, L2, L3, N, PE, mounting type: snapped, for terminal block width: 10.2 mm, lettering field size: 10,15 x 10,5 mm, Number of individual labels: 10

# PTPOWER 50 - High-current terminal block



3260050

<https://www.phoenixcontact.com/pc/products/3260050>

## ZB10,LGS:U-N - Marker for terminal blocks

1053438

<https://www.phoenixcontact.com/pc/products/1053438>



Marker for terminal blocks, Strip, white, labeled, can be labeled with: CMS-P1-PLOTTER, horizontal: U, V, W, N, GND, U, V, W, N, GND, mounting type: snapped, for terminal block width: 10.2 mm, lettering field size: 10,15 x 10,5 mm, Number of individual labels: 10

---

## UC-TM 10 - Marker for terminal blocks

0818069

<https://www.phoenixcontact.com/pc/products/0818069>



Marker for terminal blocks, Sheet, white, unlabeled, can be labeled with: BLUEMARK ID COLOR, BLUEMARK ID, BLUEMARK CLED, PLOTMARK, CMS-P1-PLOTTER, mounting type: snapped, for terminal block width: 10.2 mm, lettering field size: 9.6 x 10.5 mm, Number of individual labels: 48

# PTPOWER 50 - High-current terminal block



3260050

<https://www.phoenixcontact.com/pc/products/3260050>

## UC-TM 10 CUS - Marker for terminal blocks

0824605

<https://www.phoenixcontact.com/pc/products/0824605>



Marker for terminal blocks, can be ordered: by sheet, white, labeled according to customer specifications, mounting type: snap into tall marker groove, for terminal block width: 10.2 mm, lettering field size: 9.6 x 10.5 mm, Number of individual labels: 48

---

## UCT-TM 10 - Marker for terminal blocks

0829142

<https://www.phoenixcontact.com/pc/products/0829142>



Marker for terminal blocks, Sheet, white, unlabeled, can be labeled with: TOPMARK NEO, TOPMARK LASER, BLUEMARK ID COLOR, BLUEMARK ID, BLUEMARK CLED, THERMOMARK PRIME, THERMOMARK CARD 2.0, THERMOMARK CARD, mounting type: snapped, for terminal block width: 10.2 mm, lettering field size: 8.9 x 9.6 mm, Number of individual labels: 36



# PTPOWER 50 - High-current terminal block



3260050

<https://www.phoenixcontact.com/pc/products/3260050>

## UCT-TM 10 CUS - Marker for terminal blocks

0829623

<https://www.phoenixcontact.com/pc/products/0829623>



Marker for terminal blocks, can be ordered: by sheet, white, labeled according to customer specifications, mounting type: snap into tall marker groove, for terminal block width: 10.2 mm, lettering field size: 8.9 x 9.6 mm, Number of individual labels: 36

---

## ZBF10:UNBEDRUCKT - Zack Marker strip, flat

0809997

<https://www.phoenixcontact.com/pc/products/0809997>



Zack Marker strip, flat, Strip, white, unlabeled, can be labeled with: CMS-P1-PLOTTER, PLOTMARK, mounting type: snapped, for terminal block width: 10 mm, lettering field size: 5.15 x 10 mm, Number of individual labels: 10

# PTPOWER 50 - High-current terminal block



3260050

<https://www.phoenixcontact.com/pc/products/3260050>

## ZBF10 CUS - Zack Marker strip, flat

0825031

<https://www.phoenixcontact.com/pc/products/0825031>



Zack Marker strip, flat, can be ordered: Strip, white, labeled according to customer specifications, mounting type: snap into flat marker groove, for terminal block width: 10 mm, lettering field size: 5.15 x 10 mm, Number of individual labels: 10

---

## ZBF10,LGS:FORTL.ZAHLEN - Zack Marker strip, flat

0810009

<https://www.phoenixcontact.com/pc/products/0810009>



Zack Marker strip, flat, Strip, white, labeled, printed horizontally: consecutive numbers 1 ... 10, 11 ... 20, etc. up to 91 ... 100, mounting type: snapped, for terminal block width: 10 mm, lettering field size: 5.15 x 10 mm, Number of individual labels: 10

# PTPOWER 50 - High-current terminal block



3260050

<https://www.phoenixcontact.com/pc/products/3260050>

## ZBF10,QR:FORTL.ZAHLEN - Zack Marker strip, flat

0810025

<https://www.phoenixcontact.com/pc/products/0810025>



Zack Marker strip, flat, Strip, white, labeled, Printed vertically: consecutive numbers 1 ... 10, 11 ... 20, etc. up to 91 ... 100, mounting type: snapped, for terminal block width: 10 mm, lettering field size: 5.15 x 10 mm, Number of individual labels: 10

---

## UC-TMF 10 - Marker for terminal blocks

0818124

<https://www.phoenixcontact.com/pc/products/0818124>



Marker for terminal blocks, Sheet, white, unlabeled, can be labeled with: BLUEMARK ID COLOR, BLUEMARK ID, BLUEMARK CLED, PLOTMARK, CMS-P1-PLOTTER, mounting type: snapped, for terminal block width: 10.2 mm, lettering field size: 9.6 x 5.1 mm, Number of individual labels: 48

# PTPOWER 50 - High-current terminal block



3260050

<https://www.phoenixcontact.com/pc/products/3260050>

## UC-TMF 10 CUS - Marker for terminal blocks

0824662

<https://www.phoenixcontact.com/pc/products/0824662>



Marker for terminal blocks, can be ordered: by sheet, white, labeled according to customer specifications, mounting type: snap into flat marker groove, for terminal block width: 10.2 mm, lettering field size: 9.6 x 5.1 mm, Number of individual labels: 48

---

## UCT-TMF 10 - Marker for terminal blocks

0829204

<https://www.phoenixcontact.com/pc/products/0829204>



Marker for terminal blocks, Sheet, white, unlabeled, can be labeled with: TOPMARK NEO, TOPMARK LASER, BLUEMARK ID COLOR, BLUEMARK ID, BLUEMARK CLED, THERMOMARK PRIME, THERMOMARK CARD 2.0, THERMOMARK CARD, mounting type: snapped, for terminal block width: 10.2 mm, lettering field size: 9.4 x 4.7 mm, Number of individual labels: 36

# PTPOWER 50 - High-current terminal block



3260050

<https://www.phoenixcontact.com/pc/products/3260050>

## UCT-TMF 10 CUS - Marker for terminal blocks

0829679

<https://www.phoenixcontact.com/pc/products/0829679>



Marker for terminal blocks, can be ordered: by sheet, white, labeled according to customer specifications, mounting type: snap into flat marker groove, for terminal block width: 10.2 mm, lettering field size: 9.4 x 4.7 mm, Number of individual labels: 36

---

## MPS-MT - Test plug

0201744

<https://www.phoenixcontact.com/pc/products/0201744>



Test plug, with solder connection up to 1 mm<sup>2</sup> conductor cross section, number of positions: 1, color: gray

# PTPOWER 50 - High-current terminal block



3260050

<https://www.phoenixcontact.com/pc/products/3260050>

## MPS-IH WH - Insulating sleeve

0201663

<https://www.phoenixcontact.com/pc/products/0201663>

Insulating sleeve, color: white



---

## MPS-IH RD - Insulating sleeve

0201676

<https://www.phoenixcontact.com/pc/products/0201676>

Insulating sleeve, color: red



# PTPOWER 50 - High-current terminal block



3260050

<https://www.phoenixcontact.com/pc/products/3260050>

## MPS-IH BU - Insulating sleeve

0201689

<https://www.phoenixcontact.com/pc/products/0201689>

Insulating sleeve, color: blue

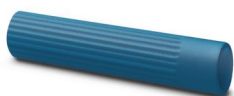

---

## MPS-IH YE - Insulating sleeve

0201692

<https://www.phoenixcontact.com/pc/products/0201692>

Insulating sleeve, color: yellow



# PTPOWER 50 - High-current terminal block



3260050

<https://www.phoenixcontact.com/pc/products/3260050>

## MPS-IH GN - Insulating sleeve

0201702

<https://www.phoenixcontact.com/pc/products/0201702>

Insulating sleeve, color: green



---

## MPS-IH GY - Insulating sleeve

0201728

<https://www.phoenixcontact.com/pc/products/0201728>

Insulating sleeve, color: gray





# PTPOWER 50 - High-current terminal block



3260050

<https://www.phoenixcontact.com/pc/products/3260050>

## MPS-IH BK - Insulating sleeve

0201731

<https://www.phoenixcontact.com/pc/products/0201731>

Insulating sleeve, color: black



---

## SZF 3-1,0X5,5 - Screwdriver

1206612

<https://www.phoenixcontact.com/pc/products/1206612>

Actuation tool, for ST terminal blocks, also suitable for use as a bladed screwdriver, size: 1.0 x 5.5 x 150 mm, 2-component grip, with non-slip grip



# PTPOWER 50 - High-current terminal block

3260050

<https://www.phoenixcontact.com/pc/products/3260050>

## SZS 0,8X4,0 VDE - Screwdriver

1212508

<https://www.phoenixcontact.com/pc/products/1212508>



Screwdriver, slot-headed, VDE insulated, size: 0.8 x 4.0 x 100 mm, 2-component grip, with non-slip grip

---

## CRIMPFOX CENTRUS 10S - Crimping pliers

1213154

<https://www.phoenixcontact.com/pc/products/1213154>



Crimping pliers, for uninsulated and insulated ferrules, DIN 46228 Part 1 and 4, from 0.14 mm<sup>2</sup> ... 10 mm<sup>2</sup>, also for TWIN ferrules up to 2 x 4 mm<sup>2</sup>, automatic cross section adjustment, lateral insertion, equipped with fall protection

# PTPOWER 50 - High-current terminal block

3260050

<https://www.phoenixcontact.com/pc/products/3260050>

## CRIMPFOX CENTRUS 10H - Crimping pliers

1213156

<https://www.phoenixcontact.com/pc/products/1213156>



Crimping pliers, for uninsulated and insulated ferrules, DIN 46228 Part 1 and 4, from 0.14 mm<sup>2</sup> ... 10 mm<sup>2</sup>, also for TWIN ferrules up to 2 x 4 mm<sup>2</sup>, automatic cross section adjustment, lateral insertion, equipped with fall protection

---

## CRIMPFOX 10S - Crimping pliers

1212045

<https://www.phoenixcontact.com/pc/products/1212045>



Crimping pliers, for ferrules without insulating collar according to DIN 46228 Part 1 and ferrules with insulating collar according to DIN 46228 Part 4, 0.14 mm<sup>2</sup> ... 10 mm<sup>2</sup>, unlockable pressure lock, lateral entry

# PTPOWER 50 - High-current terminal block

3260050

<https://www.phoenixcontact.com/pc/products/3260050>

## CRIMPFOX 10 - Crimping pliers

1212721

<https://www.phoenixcontact.com/pc/products/1212721>



Crimping pliers, for ferrules without insulating collar according to DIN 46228 Part 1 and ferrules with insulating collar according to DIN 46228 Part 4, 4 mm<sup>2</sup> ... 10 mm<sup>2</sup>, lateral entry, trapezoidal crimp

---

## CRIMPFOX 25R - Crimping pliers

1212039

<https://www.phoenixcontact.com/pc/products/1212039>



Crimping pliers, for ferrules without insulating collar according to DIN 46228 Part 1 and ferrules with insulating collar according to DIN 46228 Part 4, 10 mm<sup>2</sup> ... 25 mm<sup>2</sup>, lateral entry, WM crimp

# PTPOWER 50 - High-current terminal block

3260050

<https://www.phoenixcontact.com/pc/products/3260050>

## CRIMPFOX 50R - Crimping pliers

1212041

<https://www.phoenixcontact.com/pc/products/1212041>



Crimping pliers, for ferrules without insulating collar according to DIN 46228 Part 1 and ferrules with insulating collar according to DIN 46228 Part 4, 35 mm<sup>2</sup> ... 50 mm<sup>2</sup>, lateral entry, WM crimp

---

## CRIMPFOX-M - Crimping pliers

1212072

<https://www.phoenixcontact.com/pc/products/1212072>



Basic pliers, for accommodating dies for a wide range of type of contacts

# PTPOWER 50 - High-current terminal block



3260050

<https://www.phoenixcontact.com/pc/products/3260050>

## CRIMPFOX-C120 - Crimping pliers

1212318

<https://www.phoenixcontact.com/pc/products/1212318>



Basic pliers, for accommodating dies for a wide range of type of contacts up to 120 mm<sup>2</sup>

---

## CEC PTPOWER 35/50 - Cover

1056086

<https://www.phoenixcontact.com/pc/products/1056086>



Cover, yellow, labeled: Lightning flash, mounting type: plug in

# PTPOWER 50 - High-current terminal block



3260050

<https://www.phoenixcontact.com/pc/products/3260050>

## PROJECT COMPLETE - Software

1050453

<https://www.phoenixcontact.com/pc/products/1050453>



Intuitive planning and marking software for configuring terminal strips and for professional marking of marking materials for terminal blocks, conductors, cables, devices, and systems. The software is available for download

---

## A 10 -32 - Ferrule

1090629

<https://www.phoenixcontact.com/pc/products/1090629>



Ferrule, color: silver

# PTPOWER 50 - High-current terminal block



3260050

<https://www.phoenixcontact.com/pc/products/3260050>

## A 16 -32 - Ferrule

1090633

<https://www.phoenixcontact.com/pc/products/1090633>



Ferrule, color: silver

---

## A 25 -32 - Ferrule

1090636

<https://www.phoenixcontact.com/pc/products/1090636>



Ferrule, color: silver



# PTPOWER 50 - High-current terminal block



3260050

<https://www.phoenixcontact.com/pc/products/3260050>

## A 35 -32 - Ferrule

1090638

<https://www.phoenixcontact.com/pc/products/1090638>

Ferrule, color: silver



---

## A 50 -32 - Ferrule

1090639

<https://www.phoenixcontact.com/pc/products/1090639>

Ferrule, color: silver



---

Phoenix Contact 2024 © - all rights reserved  
<https://www.phoenixcontact.com>

PHOENIX CONTACT GmbH & Co. KG  
Flachsmarktstraße 8  
D-32825 Blomberg  
+49 (0) 5235-3 00  
[info@phoenixcontact.com](mailto:info@phoenixcontact.com)