

# Data Sheet | Item Number: 750-377

## Fieldbus Coupler PROFINET IO; 3rd Generation; ECO Advanced

<https://www.wago.com/750-377>

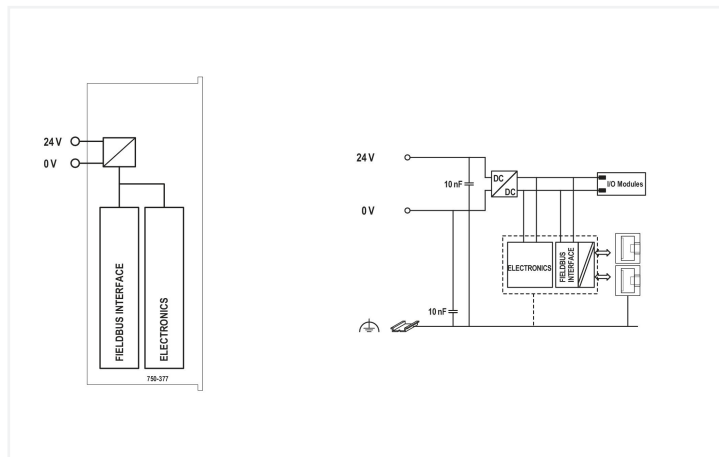

Color:  light gray

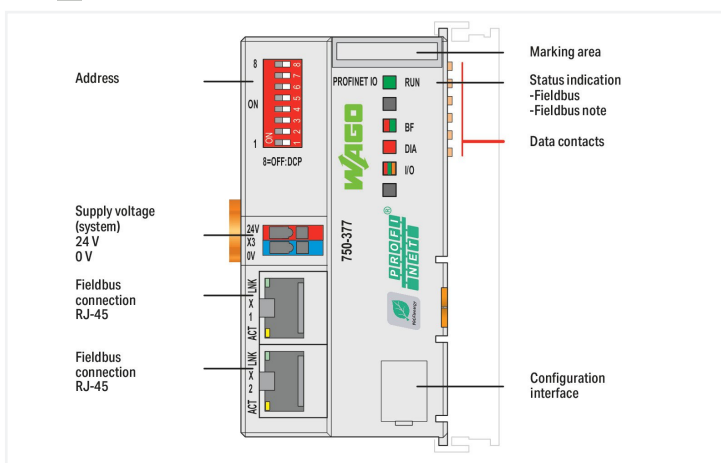

This fieldbus coupler connects the WAGO I/O System 750 to PROFINET IO (open, real-time Industrial ETHERNET automation standard). The coupler identifies the connected I/O modules and creates local process images for one I/O controller and one I/O supervisor according to preset configurations. This process image may include a mixed arrangement of analog (word-by-word data transfer) or complex modules and digital (bit-by-bit data transfer) modules. The fieldbus coupler operates as an I/O device in the network. It features an integrated 2-port switch, simplifying the creation of a line structure without additional network components. The device name can be assigned via DCP protocol or a default name can be instantiated via DIP switch.

### Technical data

Communication	PROFINET IO
Device-specific	Supported profiles: PROFIsafe V2, PROFINergy V1.0; ID code: Vendor ID: 0x011D; Device ID: 0x02EE; Module ID: 0x01000177 (firmware version 01, 02), 0x02000177 (from firmware version 03)
Baud rate	10/100 Mbit/s (10 Mbit/s (ETHERNET protocols), 100 Mbit/s full duplex (PROFINET IO))
Bus segment length (max.)	100 m
Transmission medium	Twisted pair S-UTP; 100 Ω; Cat. 5
Number of modules per node (max.)	64
Input and output process image (fieldbus) max.	256 bytes/256 bytes
Supply voltage (system)	24 VDC (-25 ... +30 %); via pluggable connector
Current consumption (5 V system supply)	450 mA
Total current (system supply)	700 mA
Input current (typ.) at nominal load (24 V)	280 mA
Power supply efficiency (typ.) at nominal load (24 V)	90 %
Isolation	500 V system/field

### Connection data

Connection technology: communication/fieldbus	PROFINET IO: 2 x RJ-45
Connection technology: system supply	2 x CAGE CLAMP®
Connection technology: device configuration	1 x Male connector; 4-pole
Connection type 1	System supply
Solid conductor	0.08 ... 1.5 mm <sup>2</sup> / 28 ... 14 AWG
Fine-stranded conductor	0.08 ... 1.5 mm <sup>2</sup> / 28 ... 14 AWG
Strip length	5 ... 6 mm / 0.2 ... 0.24 inches

### Physical data

Width	49.5 mm / 1.949 inches
Height	96.8 mm / 3.811 inches
Depth	71.9 mm / 2.831 inches
Depth from upper-edge of DIN-rail	64.7 mm / 2.547 inches

### Mechanical Data

Mounting type	DIN-35 rail
---------------	-------------

### Material Data

Color	light gray
Housing material	Polycarbonate; polyamide 6.6
Fire load	1.393 MJ
Weight	107.1 g
Conformity marking	CE

### Environmental requirements

Ambient temperature (operation)	0 ... +55 °C
Surrounding air temperature (storage)	-25 ... +85 °C
Protection type	IP20
Pollution degree (5)	2 per IEC 61131-2
Operating altitude	0 ... 2000 m / 0 ... 6562 ft
Mounting position	horizontal (standing/lying); vertical
Relative humidity (without condensation)	95 %
Vibration resistance	4g per IEC 60068-2-6
Shock resistance	15g per IEC 60068-2-27
EMC immunity to interference	per EN 61000-6-2, marine applications
EMC emission of interference	per EN 61000-6-3, marine applications
Exposure to pollutants	per IEC 60068-2-42 and IEC 60068-2-43
Permissible H <sub>2</sub> S contaminant concentration at a relative humidity 75 %	10 ppm
Permissible SO <sub>2</sub> contaminant concentration at a relative humidity 75 %	25 ppm

### Commercial data

Product Group	15 (I/O System)
eCl@ss 10.0	27-24-26-07
eCl@ss 9.0	27-24-26-07
ETIM 8.0	EC001603
ETIM 7.0	EC001603
PU (SPU)	1 pcs
Packaging type	Box
Country of origin	DE
GTIN	4050821687443
Customs tariff number	85176200000

## Approvals / Certificates

## General approvals



Approval	Standard	Certificate Name
EAC Brjansker Zertifizierungs- stelle	TP TC 020/2011	EAC RU C-DE.AM02. B.00087/19
KC National Radio Research Agency	Article 58-2, Clause 3	MSIP-REM-W43-FBC750
UL Underwriters Laboratories Inc. (ORDINARY LOCATI- ONS)	UL 508	E175199 Sec.1

## Approvals for marine applications



Approval	Standard	Certificate Name
ABS American Bureau of Ship- ping	-	22-2219060
BSH Bundesamt fuer See- schifffahrt und Hydrogra- phie	-	1104
LR Lloyds Register EMEA	-	LR22180952TA
PRS Polski Rejestr Statków	-	TE/2236/880590/19
RINA RINA Germany GmbH	-	ELE343521XG001

## Approvals for hazardous areas



Approval	Standard	Certificate Name
ATEX TUEV Nord Cert GmbH	EN 60079-0	
CCC CNEX	CNCA-C23-01	2020312310000213 (Ex ec IIC T4 Gc)
EAC Brjansker Zertifizierungs- stelle	TP TC 012/2011	EAC RU C-DE.AM02. B.00163/19 (2Ex e IIC T4 Gc X)
IECEX TUEV Nord Cert GmbH	IEC 60079-0	IECEX_TUN_14.0035_X (Ex ec IIC T4 Gc)
INMETRO TÜV Rheinland do Brasil Ltda.	IEC 60079-0	BR-Ex_TÜV 12.1297 X
UKEx WAGO GmbH & Co. KG	EN 60079-0	UKCA_WA GO22UKEX003X_ec
UL Underwriters Laboratories Inc. (HAZARDOUS LOCA- TIONS)	UL 121201	E198726 Sec.1

## Downloads

## Environmental Product Compliance

## Compliance Search

Environmental Product  
Compliance 750-377



## Documentation

Manual			
System Manual WAGO I/O System 750/753	V 3.1.0 05.12.2022	pdf 8495.90 KB	<a href="#">↓</a>
System Manual Series 750/753			<a href="#">↓</a>
Product Manual PROFINET IO advanced ECO Fieldbus Coupler	V 1.3.1 17.08.2020	pdf 7755.31 KB	<a href="#">↓</a>

System Description			
750/753 Series I/O-System – General Product Information		pdf 953.35 KB	<a href="#">↓</a>
Overview on WAGO-I/O-SYSTEM 750 approvals		pdf 770.48 KB	<a href="#">↓</a>
Use in Hazardous Environments	V 1.0.0	pdf 1007.06 KB	<a href="#">↓</a>

Bid Text			
750-377	21.07.2017	doc 31.50 KB	<a href="#">↓</a>
750-377	19.02.2019	xml 6.79 KB	<a href="#">↓</a>

## Application Notes

Application note SIEMENS			
Using iPar-Server option with WAGO PROFIsafe modules (a114802)	V 14.0 04.07.2022	zip 97442.64 KB	<a href="#">↓</a>

## CAD/CAE-Data

CAD data	
2D/3D Models 750-377	<a href="#">↓</a>

CAE data	
EPLAN Data Portal 750-377	<a href="#">↓</a>
WSCAD Universe 750-377	<a href="#">↓</a>
ZUKEN Portal 750-377	<a href="#">↓</a>

## Runtime Software

Firmware			
0750-0377, Feldbuskoppler PROFINET IO	V 11 24.01.2023	zip 879.92 KB	<a href="#">↓</a>

## Libraries

Device Description File			
750-916; GSD-Dateien der Version 2.x für PROFINET/ Serie 750/753, 765, 767 und 852	2.9 15.10.2021	zip 2455.88 KB	<a href="#">↓</a>

## 1 Compatible Products

### 1.1 Optional Accessories

### 1.1.1 Cables and connectors

#### 1.1.1.1 Connector plug



**Item No.: 750-979/000-013**  
Connector PROFINET; RJ-45; Cat. 6A; angled; AWG 22; Strain relief



**Item No.: 750-977/000-013**  
Connector PROFINET; RJ-45; Cat. 6A; straight; AWG 22



**Item No.: 750-978/000-013**  
Connector PROFINET; RJ-45; Cat. 6A; straight; AWG 22; Strain relief



**Item No.: 750-976**  
PROFINET RJ-45 connector, IP20; ETHER-NET 10/100 Mbit/s; for field assembly

### 1.1.2 Communication

#### 1.1.2.1 Bluetooth



**Item No.: 750-921**  
Bluetooth® Adapter

#### 1.1.2.2 Communication cable



**Item No.: 750-923**  
Configuration cable; USB connector; Length: 2.5 m



**Item No.: 750-923/000-001**  
Configuration cable; USB connector; Length: 5 m

### 1.1.3 DIN-rail

#### 1.1.3.1 Mounting accessories



**Item No.: 210-196**  
Aluminum carrier rail; 35 x 8.2 mm; 1.6 mm thick; 2 m long; unslotted; similar to EN 60715; silver-colored



**Item No.: 210-198**  
Copper carrier rail; 35 x 15 mm; 2.3 mm thick; 2 m long; unslotted; according to EN 60715; copper-colored



**Item No.: 210-508**  
Steel carrier rail; 35 x 15 mm; 1.5 mm thick; 2 m long; slotted; galvanized; similar to EN 60715; silver-colored



**Item No.: 210-197**  
Steel carrier rail; 35 x 15 mm; 1.5 mm thick; 2 m long; slotted; similar to EN 60715; silver-colored



**Item No.: 210-506**  
Steel carrier rail; 35 x 15 mm; 1.5 mm thick; 2 m long; unslotted; galvanized; similar to EN 60715; silver-colored



**Item No.: 210-114**  
Steel carrier rail; 35 x 15 mm; 1.5 mm thick; 2 m long; unslotted; similar to EN 60715; silver-colored



**Item No.: 210-118**  
Steel carrier rail; 35 x 15 mm; 2.3 mm thick; 2 m long; unslotted; according to EN 60715; silver-colored



**Item No.: 210-115**  
Steel carrier rail; 35 x 7.5 mm; 1 mm thick; 2 m long; slotted; according to EN 60715; "Hole width 18 mm; silver-colored



**Item No.: 210-112**  
Steel carrier rail; 35 x 7.5 mm; 1 mm thick; 2 m long; slotted; according to EN 60715; "Hole width 25 mm; silver-colored



**Item No.: 210-504**  
Steel carrier rail; 35 x 7.5 mm; 1 mm thick; 2 m long; slotted; galvanized; according to EN 60715; silver-colored













**Item No.: 210-113**  
Steel carrier rail; 35 x 7.5 mm; 1 mm thick; 2 m long; unslotted; according to EN 60715; silver-colored



**Item No.: 210-505**  
Steel carrier rail; 35 x 7.5 mm; 1 mm thick; 2 m long; unslotted; galvanized; according to EN 60715; silver-colored







### 1.1.4 Marking

1.1.4.1 Marker

 <p><b>Item No.: 750-100</b> Marker card; as a DIN A4 sheet; plain</p>	<p><b>Item No.: 2009-145/000-006</b> Mini-WSB Inline; for Smart Printer; 1700 pieces on roll; stretchable 5 - 5.2 mm; plain; snap-on type; blue</p>	<p><b>Item No.: 2009-145/000-007</b> Mini-WSB Inline; for Smart Printer; 1700 pieces on roll; stretchable 5 - 5.2 mm; plain; snap-on type; gray</p>	<p><b>Item No.: 2009-145/000-023</b> Mini-WSB Inline; for Smart Printer; 1700 pieces on roll; stretchable 5 - 5.2 mm; plain; snap-on type; green</p>
<p><b>Item No.: 2009-145/000-012</b> Mini-WSB Inline; for Smart Printer; 1700 pieces on roll; stretchable 5 - 5.2 mm; plain; snap-on type; orange</p>	<p><b>Item No.: 2009-145/000-005</b> Mini-WSB Inline; for Smart Printer; 1700 pieces on roll; stretchable 5 - 5.2 mm; plain; snap-on type; red</p>	<p><b>Item No.: 2009-145/000-024</b> Mini-WSB Inline; for Smart Printer; 1700 pieces on roll; stretchable 5 - 5.2 mm; plain; snap-on type; violet</p>	<p><b>Item No.: 2009-145</b> Mini-WSB Inline; for Smart Printer; 1700 pieces on roll; stretchable 5 - 5.2 mm; plain; snap-on type; white</p>
<p><b>Item No.: 2009-145/000-002</b> Mini-WSB Inline; for Smart Printer; 1700 pieces on roll; stretchable 5 - 5.2 mm; plain; snap-on type; yellow</p>	 <p><b>Item No.: 248-501/000-006</b> Mini-WSB marking card; as card; not stretchable; plain; snap-on type; blue</p>	 <p><b>Item No.: 248-501/000-007</b> Mini-WSB marking card; as card; not stretchable; plain; snap-on type; gray</p>	 <p><b>Item No.: 248-501/000-023</b> Mini-WSB marking card; as card; not stretchable; plain; snap-on type; green</p>
 <p><b>Item No.: 248-501/000-017</b> Mini-WSB marking card; as card; not stretchable; plain; snap-on type; light green</p>	 <p><b>Item No.: 248-501/000-012</b> Mini-WSB marking card; as card; not stretchable; plain; snap-on type; orange</p>	 <p><b>Item No.: 248-501/000-005</b> Mini-WSB marking card; as card; not stretchable; plain; snap-on type; red</p>	 <p><b>Item No.: 248-501/000-024</b> Mini-WSB marking card; as card; not stretchable; plain; snap-on type; violet</p>
 <p><b>Item No.: 248-501</b> Mini-WSB marking card; as card; not stretchable; plain; snap-on type; white</p>	 <p><b>Item No.: 248-501/000-002</b> Mini-WSB marking card; as card; not stretchable; plain; snap-on type; yellow</p>		

1.1.5 Shield termination

1.1.5.1 Shield clamping saddles

 <p><b>Item No.: 790-108</b> Shield clamping saddle; 11 mm wide; diameter of compatible conductor; 3 ... 8 mm</p>	 <p><b>Item No.: 790-208</b> Shield clamping saddle; 12.4 mm wide; 3 ... 8 mm</p>	 <p><b>Item No.: 790-116</b> Shield clamping saddle; 19 mm wide; diameter of compatible conductor; 7 ... 16 mm</p>	 <p><b>Item No.: 790-216</b> Shield clamping saddle; 21.8 mm wide; 6 ... 16 mm</p>
 <p><b>Item No.: 790-124</b> Shield clamping saddle; 27 mm wide; diameter of compatible conductor; 6 ... 24 mm</p>	 <p><b>Item No.: 790-220</b> Shield clamping saddle; 30 mm wide; 6 ... 20 mm</p>	 <p><b>Item No.: 790-140</b> Shield clamping saddle; diameter of compatible conductor</p>	

1.1.6 System enclosure

1.1.6.1 System enclosure

 <p><b>Item No.: 850-825</b> IP65 enclosure; Aluminium (RAL 7032); WxHxD (160x100x160 mm); 9 x M12, 4 x M20</p>	 <p><b>Item No.: 850-826</b> IP65 enclosure; Aluminium (RAL 7032); WxHxD (240x100x160 mm); 4 x M20, 4 x M16, 14 x M12 cable grip</p>	 <p><b>Item No.: 850-827</b> IP65 enclosure; Aluminium (RAL 7032); WxHxD (320x100x160 mm); 4 x M20, 8 x M16, 17 x M12 cable grip</p>	 <p><b>Item No.: 850-828</b> IP65 enclosure; Aluminium (RAL 7032); WxHxD (480x100x160 mm); 4 x M20, 10 x M16, 35 x M12 cable grip</p>
 <p><b>Item No.: 850-826/002-000</b> IP65 enclosure; Aluminium (RAL 7035); WxHxD (240x100x160 mm); 4 x M20, 4 x M16, 14 x M12 cable grip</p>	 <p><b>Item No.: 850-827/002-000</b> IP65 enclosure; Aluminium (RAL 7035); WxHxD (320x100x160 mm); 4 x M20, 8 x M16, 17 x M12 cable grip</p>	 <p><b>Item No.: 850-828/002-000</b> IP65 enclosure; Aluminium (RAL 7035); WxHxD (480x100x160 mm); 4 x M20, 10 x M16, 35 x M12 cable grip</p>	 <p><b>Item No.: 850-834</b> IP65 enclosure; Polyester (RAL 7032); WxHxD (164x100x164 mm); 9 x M12, 4 x M20</p>

1.1.6.1 System enclosure



**Item No.: 850-835**

IP65 enclosure; Polyester (RAL 7032); WxHxD (244x100x164 mm); 4 x M20, 4 x M16, 14 x M12 cable grip



**Item No.: 850-836**

IP65 enclosure; Polyester (RAL 7032); WxHxD (324x100x164 mm); 4 x M20, 8 x M16, 17 x M12 cable grip



**Item No.: 850-814/002-000**

IP65 enclosure; Sheet steel (RAL 7035); WxHxD (200x120x200 mm); without flange plate



**Item No.: 850-815/002-000**

IP65 enclosure; Sheet steel (RAL 7035); WxHxD (300x120x200 mm); without flange plate



**Item No.: 850-816/002-000**

IP65 enclosure; Sheet steel (RAL 7035); WxHxD (400x120x200 mm); without flange plate



**Item No.: 850-817/002-000**

IP65 enclosure; Sheet steel (RAL 7035); WxHxD (600x120x200 mm); without flange plate