

Data Sheet | Item Number: 765-1704/200-000

8-channel digital input/output; IO Link Class B Hub; DC 24 V / 2.0 A; 4xM12 connection; HubLine

<https://www.wago.com/765-1704/200-000>

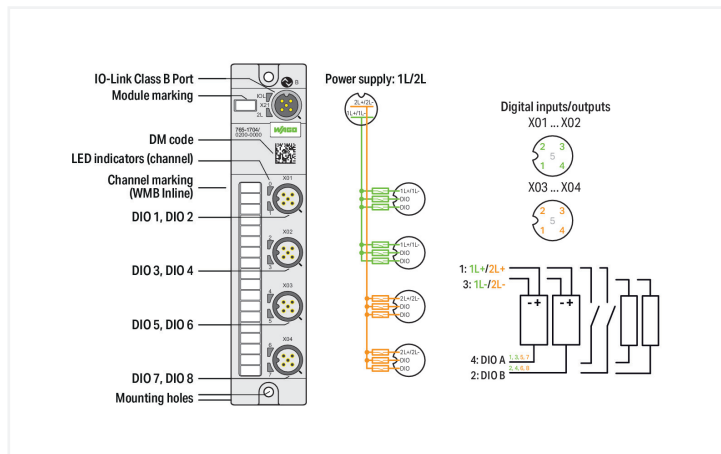

Technical data

IO-Link		Device functions	
Communication	IO-Link slave (class B)	Parameter	Input filter Output current Temperature
Connection technology: communication/fieldbus	1 x A-coded M12; 5-pole	Diagnostics	Undervoltage; overcurrent; overload; overtemperature
Digital inputs/outputs		Supply	
Number of digital inputs	8	Connection technology: supply	1 x A-coded M12; 5-pole; via IO-Link port (1L/2L)
Number of digital outputs	8	Supply voltage	24 VDC (18 ... 31.2 V); 1L/2L
Connection technology: inputs/outputs	4 x A-coded M12; 5-pole	Current consumption (max.)	4000 mA
Signal type (voltage)	24 VDC	Current consumption (note)	1L: 0.2 A; 2L: 0.1 A; + load current
Input characteristic	high-side switching Type 3, per IEC 61131-2	Reverse voltage protection	Yes
Input filter	0.2 ... 20 ms		
Output current (per channel)	2 A		

Physical data

Width	35 mm / 1.378 inches
Height	30 mm / 1.181 inches
Depth	158.5 mm / 6.24 inches

Mechanical Data

Weight	110 g
Conformity marking	CE

Environmental requirements

Ambient temperature (operation)	-25 ... +70 °C
Surrounding air temperature (storage)	-40 ... +80 °C
Protection type	IP67
Protection class	III per EN 61140, IEC 61140, VDE 0140-1
Operating altitude	0 ... 2000 m / 0 ... 6562 ft
Pollution degree (5)	3 (EN 60664-1)
Overvoltage category	II (EN 60664-1)
Vibration resistance	5g per IEC 60068-2-6
Shock resistance	Short-term: 50g/11 ms/half-sine per IEC 60068-2-27; Long-term: 30g/6 ms/half-sine per IEC 60068-2-29
EMC immunity to interference	per EN 61000-6-2
EMC emission of interference	per EN 61000-6-4

Commercial data

ETIM 8.0	EC001599
ETIM 7.0	EC001599
PU (SPU)	1 pcs
Packaging type	Box
Country of origin	DE
GTIN	4055143949866
Customs tariff number	85371098990

Downloads

Environmental Product Compliance

Compliance Search

Environmental Product
Compliance
765-1704/200-000



Documentation

Manual

Product Manual 8- Channel Digital Input/ Output; IO-Link Class B Hub	V 2.0.0 19.07.2022	pdf 3606.60 KB	
---	-----------------------	-------------------	---

System Description

WAGO I/O System Field; General Product Infor- mation	pdf 1009.23 KB	
--	-------------------	---

Instruction Leaflet

I/O System Field packa- ge insert	15.12.2021	pdf 1083.98 KB	
--------------------------------------	------------	-------------------	---

CAD/CAE-Data

CAD data

2D/3D Models
765-1704/200-000 

CAE data

EPLAN Data Portal
765-1704/200-000 

ZUKEN Portal
765-1704/200-000 

Runtime Software

Firmware

0765-17xx, IO-Field	V 01	zip	333.28 KB	
---------------------	------	-----	-----------	---

1 Compatible Products

1.1 Required Accessories

1.1.1 Cover

1.1.1.1 Cover



[Item No.: 756-8103](#)
M12 protective cap; for unused plugs

[Item No.: 756-8102](#)
M12 protective cap; for unused sockets

1.1.2 Marking

1.1.2.1 Marker



[Item No.: 2009-115](#)
WMB-Inline; for Smart Printer; 1500 pieces on roll; stretchable 5 - 5.2 mm; plain; snap-on type; white

1.1.2.2 Marking strip



[Item No.: 2009-110](#)
Marking strips; for Smart Printer; on reel; not stretchable; plain; snap-on type; white

1.1.3 Tool

1.1.3.1 Assembly tool



Item No.: 206-701
Torque wrench M8 and M12; Assembly kit

1.2 Optional Accessories

1.2.1 Cables and connectors

1.2.1.1 Configurable connectors



Item No.: 756-9205/050-000
Fitted pluggable connector; 5-pole; M12 plug, right angle; Spring



Item No.: 756-9202/050-000
Fitted pluggable connector; 5-pole; M12 plug, straight, A-coded; Spring



Item No.: 756-9215/050-000
Fitted pluggable connector; 5-pole; M12 socket, right angle; Spring



Item No.: 756-9212/050-000
Fitted pluggable connector; 5-pole; M12 socket, straight; Spring

1.2.1.2 Distribution connector



Item No.: 756-9301/040-000
Accessories; 4-pole



Item No.: 756-9301/050-000
Accessories; 5-pole



Item No.: 756-5514/040-010
Sensor/Actuator cable; 2xM8 socket; angled; M12A plug; straight; 4-pole; Length: 1 m



Item No.: 756-5514/040-020
Sensor/Actuator cable; 2xM8 socket; angled; M12A plug; straight; 4-pole; Length: 2 m



Item No.: 756-5513/040-010
Sensor/Actuator cable; 2xM8 socket; straight; M12A plug; straight; 4-pole; Length: 1 m



Item No.: 756-5513/040-020
Sensor/Actuator cable; 2xM8 socket; straight; M12A plug; straight; 4-pole; Length: 2 m

1.2.1.3 Sensor/actuator cable



Item No.: 756-5312/040-015
Sensor/Actuator cable; M12A plug; angled; 4-pole; Length: 1.5 m



Item No.: 756-5312/040-100
Sensor/Actuator cable; M12A plug; angled; 4-pole; Length: 10 m



Item No.: 756-5312/040-050
Sensor/Actuator cable; M12A plug; angled; 4-pole; Length: 5 m



Item No.: 756-5311/040-015
Sensor/Actuator cable; M12A plug; straight; 4-pole; Length: 1.5 m



Item No.: 756-5311/040-100
Sensor/Actuator cable; M12A plug; straight; 4-pole; Length: 10 m



Item No.: 756-5311/040-050
Sensor/Actuator cable; M12A plug; straight; 4-pole; Length: 5 m



Item No.: 756-5302/050-015
Sensor/Actuator cable; M12A socket; angled; 5-pole; Length: 1.5 m



Item No.: 756-5302/050-100
Sensor/Actuator cable; M12A socket; angled; 5-pole; Length: 10 m



Item No.: 756-5302/050-050
Sensor/Actuator cable; M12A socket; angled; 5-pole; Length: 5 m



Item No.: 756-5404/040-010
Sensor/Actuator cable; M12A socket; angled; M12A plug; angled; 4-pole; Length: 1 m



Item No.: 756-5404/040-020
Sensor/Actuator cable; M12A socket; angled; M12A plug; angled; 4-pole; Length: 2 m



Item No.: 756-5404/050-010
Sensor/Actuator cable; M12A socket; angled; M12A plug; angled; 5-pole; Length: 1 m



Item No.: 756-5404/050-020
Sensor/Actuator cable; M12A socket; angled; M12A plug; angled; 5-pole; Length: 2 m



Item No.: 756-5403/040-010
Sensor/Actuator cable; M12A socket; angled; M12A plug; straight; 4-pole; Length: 1 m



Item No.: 756-5403/040-020
Sensor/Actuator cable; M12A socket; angled; M12A plug; straight; 4-pole; Length: 2 m



Item No.: 756-5403/050-010
Sensor/Actuator cable; M12A socket; angled; M12A plug; straight; 5-pole; Length: 1 m



Item No.: 756-5403/050-020
Sensor/Actuator cable; M12A socket; angled; M12A plug; straight; 5-pole; Length: 2 m



Item No.: 756-5301/050-015
Sensor/Actuator cable; M12A socket; straight; 5-pole; Length: 1.5 m



Item No.: 756-5301/050-100
Sensor/Actuator cable; M12A socket; straight; 5-pole; Length: 10 m



Item No.: 756-5301/050-050
Sensor/Actuator cable; M12A socket; straight; 5-pole; Length: 5 m

1.2.1.3 Sensor/actuator cable



Item No.: 756-5402/040-010

Sensor/Actuator cable; M12A socket; straight; M12A plug; angled; 4-pole; Length: 1 m

Item No.: 756-5402/040-020

Sensor/Actuator cable; M12A socket; straight; M12A plug; angled; 4-pole; Length: 2 m

Item No.: 756-5402/050-010

Sensor/Actuator cable; M12A socket; straight; M12A plug; angled; 5-pole; Length: 1 m

Item No.: 756-5402/050-020

Sensor/Actuator cable; M12A socket; straight; M12A plug; angled; 5-pole; Length: 2 m



Item No.: 756-5401/040-010

Sensor/Actuator cable; M12A socket; straight; M12A plug; straight; 4-pole; Length: 1 m

Item No.: 756-5401/040-020

Sensor/Actuator cable; M12A socket; straight; M12A plug; straight; 4-pole; Length: 2 m

Item No.: 756-5401/050-010

Sensor/Actuator cable; M12A socket; straight; M12A plug; straight; 5-pole; Length: 1 m

Item No.: 756-5401/050-020

Sensor/Actuator cable; M12A socket; straight; M12A plug; straight; 5-pole; Length: 2 m



Item No.: 756-5510/040-010

Sensor/Actuator cable; M8 socket; angled; M12A plug; angled; 4-pole; Length: 1 m

Item No.: 756-5510/040-020

Sensor/Actuator cable; M8 socket; angled; M12A plug; angled; 4-pole; Length: 2 m

Item No.: 756-5509/040-010

Sensor/Actuator cable; M8 socket; angled; M12A plug; straight; 4-pole; Length: 1 m

Item No.: 756-5509/040-020

Sensor/Actuator cable; M8 socket; angled; M12A plug; straight; 4-pole; Length: 2 m



Item No.: 756-5508/040-010

Sensor/Actuator cable; M8 socket; straight; M12A plug; angled; 4-pole; Length: 1 m

Item No.: 756-5508/040-020

Sensor/Actuator cable; M8 socket; straight; M12A plug; angled; 4-pole; Length: 2 m

Item No.: 756-5507/040-010

Sensor/Actuator cable; M8 socket; straight; M12A plug; straight; 4-pole; Length: 1 m

Item No.: 756-5507/040-020

Sensor/Actuator cable; M8 socket; straight; M12A plug; straight; 4-pole; Length: 2 m