

# Standard 1/2" range

## ▶ Bit sockets 1/2"

### STM 1/2" drive metric hexagon bit sockets



- For hexagon socket heads.
- Non-removable bits.

	S mm	D mm	I mm	L mm	ΔΔ g
<b>STM.4</b>	4,00	22,8	24	60	59
<b>STM.5</b>	5,00	22,8	24	60	60
<b>STM.6</b>	6,00	22,8	24	60	62
<b>STM.7</b>	7,00	22,8	24	60	64
<b>STM.8</b>	8,00	22,8	24	60	65
<b>STM.10</b>	10,00	22,8	24	60	80
<b>STM.12</b>	12,00	23,1	24	60	102
<b>STM.14</b>	14,00	23,1	24	60	127
<b>STM.17</b>	17,00	23,4	24	60	152
<b>STM.19</b>	19,00	23,4	24	60	162



### STM 1/2" drive inch hexagon bit sockets

- For hexagon socket heads.
- Removable bits.

	S		Components		D mm	I mm	L mm	ΔΔ g
	"	mm						
<b>ST.1/4</b>	1/4	6,35	S.236	EH.201/4	23	17	54	67
<b>ST.5/16</b>	5/16	7,94	S.236	EH.205/16	23	17	54	67
<b>ST.3/8</b>	3/8	9,52	S.236	EH.203/8	23	17	54	74
<b>ST.7/16</b>	7/16	11,11	S.237	ENH.307/16	23	31	70	110
<b>ST.1/2</b>	1/2	12,70	S.237	ENH.301/2	23	31	70	117
<b>ST.9/16</b>	9/16	14,29	S.237	ENH.309/16	23	31	70	125
<b>ST.5/8</b>	5/8	15,88	S.237	ENH.305/8	23	31	70	143
<b>ST.3/4</b>	3/4	19,05	S.237	ENH.303/4	23	31	70	165

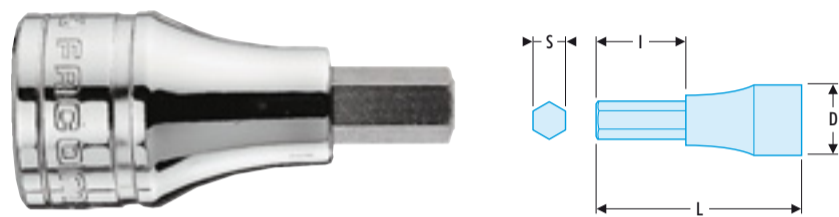

### Set of 1/2" drive metric hexagon bit sockets

#### STM.J9

- Comprising : STM.5, STM.6, STM.7, STM.8, STM.10, STM.12, STM.14, STM.17, STM.19.
- Plastic case BP.102 : 204 x 122 x 52 mm.
- Tray PL.458.



### SHP 1/2" drive long-reach metric hexagon bit sockets

- Long-reach series.
- Non-removable bits.
- Square drive  1/2".

	S mm	I mm	L mm	ΔΔ g
<b>SHP.6LA</b>	6	64	100	77
<b>SHP.7LA</b>	7	64	100	78
<b>SHP.8LA</b>	8	64	100	79
<b>SHP.10LA</b>	10	104	140	132
<b>SHP.12LA</b>	12	64	100	144
<b>SHP.5ELA</b>	5	144	180	112
<b>SHP.6EL1A</b>	6	104	140	93
<b>SHP.6EL2A</b>	6	184	220	127

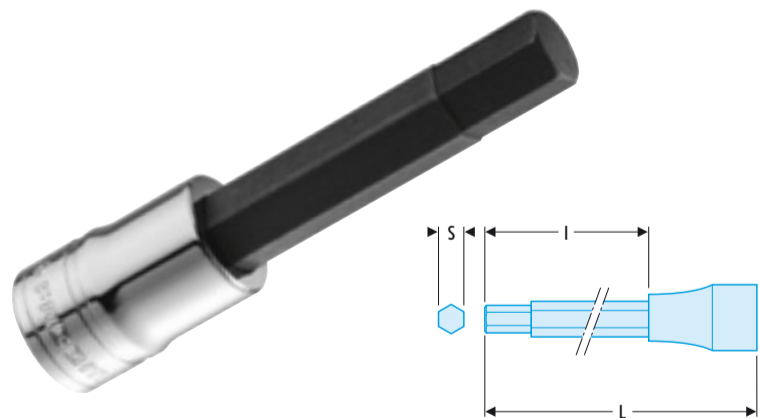

### SXM 1/2" drive Torx® bit sockets

- Non-removable bits.

	Torx® no.	I★ A mm	D mm	I mm	L mm	ΔΔ g
<b>SXM.20</b>	T20	3,84	22,8	24	60	58
<b>SXM.25</b>	T25	4,40	22,8	24	60	58
<b>SXM.27</b>	T27	4,96	22,8	24	60	59
<b>SXM.30</b>	T30	5,49	22,8	24	60	59
<b>SXM.40</b>	T40	6,60	22,8	24	60	62
<b>SXM.45</b>	T45	7,77	22,8	24	60	63
<b>SXM.50</b>	T50	8,79	22,8	24	60	74
<b>SXM.55</b>	T55	11,17	22,8	24	60	96
<b>SXM.60</b>	T60	13,17	23,1	24	60	117

