

PLEASE CHECK WWW.MOLEX.COM FOR LATEST PART INFORMATION

Part Number: [0955032661](#)
Status: **Active**
Overview: Magnetic and Modular Jacks/Plugs
Description: Modular Jack, Vertical, Top Entry, Through Hole, 6/6, No Key Version, Tray

Documents:

3D Model	Test Summary STR-1181-001 (PDF)
Drawing (PDF)	Test Summary STR-1429-001 (PDF)
Product Specification PS-95503-001-001 (PDF)	RoHS Certificate of Compliance (PDF)
Application Specification AS-85513-001-001 (PDF)	Product Literature (PDF)
Packaging Specification PK-95003-003 (PDF)	

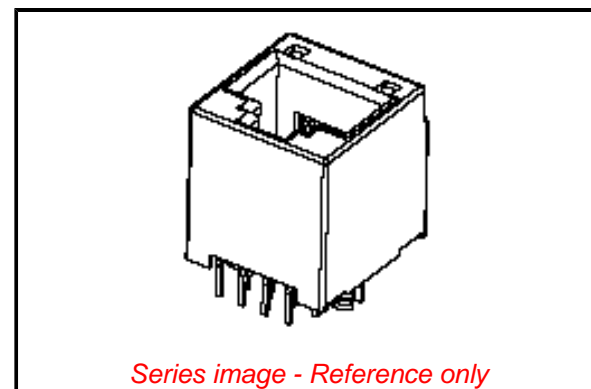

Agency Certification

UL E107635

General

Product Family	Modular Jacks/Plugs
Series	95503
Comments	Reflow Capable, Reflow Capable
Component Type	PCB Jack
Magnetic	No
Overview	Magnetic and Modular Jacks/Plugs
Performance Category	3
Power over Ethernet (PoE)	N/A
Product Literature Order No	987650-8441
Product Name	Modular Jack 6/6
UPC	800756804811

Physical

Boot Color	N/A
Color - Resin	Black
Durability (mating cycles max)	2500
Flammability	94V-0
Inverted / Top Latch	No
Jack Height	15.70mm
Keying to Mating Part	None
Lightpipes/LEDs	None
Material - Metal	Copper Alloy
Material - Plating Mating	Gold over Palladium Nickel
Material - Plating Termination	Tin
Material - Resin	High Temperature Thermoplastic
Net Weight	2.491/g
Orientation	Vertical (Top Entry)
PCB Locator	Yes
PCB Retention	Yes
PCB Thickness - Recommended	1.57mm
Packaging Type	Tray
Pitch - Mating Interface	1.02mm
Pitch - Termination Interface	1.27mm
Plating min - Mating	0.051µm, 1.016µm
Plating min - Termination	1.905µm
Port Configuration	1x1
Positions / Loaded Contacts	6/6
Surface Mount Compatible (SMC)	Yes
Temperature Range - Operating	-40° to +85°C
Termination Interface: Style	Through Hole
Waterproof / Dustproof	No

EU ELV

Not Relevant

EU RoHS

Compliant

REACH SVHC

Not Contained Per
-ED/88/2018 (15
January 2019)

Halogen-Free

Status

Low-Halogen

For more information, please visit [Contact US](#)

China ROHS

ELV

RoHS Phthalates

China RoHS

Green Image

Not Relevant

Not Contained

Search Parts in this Series

[95503](#) Series

Mates With

[90075](#) Modular Plug

Wire/Cable Type	N/A
Electrical	
Current - Maximum per Contact	1.5A
Shielded	No
Voltage - Maximum	125V DC

Solder Process Data

Duration at Max. Process Temperature (seconds)	005
Lead-free Process Capability	WAVE
Max. Cycles at Max. Process Temperature	001
Process Temperature max. C	260

Material Info**Reference - Drawing Numbers**

Application Specification	AS-85513-001-001
Packaging Specification	PK-95003-003
Product Specification	PS-95503-001-001
Sales Drawing	SD-95503-003
Test Summary	STR-1181-001, STR-1429-001

This document was generated on 04/29/2019

PLEASE CHECK WWW.MOLEX.COM FOR LATEST PART INFORMATION