



Alcoswitch | Alcoswitch AVH25

TE Internal #: 2-2364700-0

Push Button Switches, Single Pole - Double Throw Configuration (Pole-Throw), Anti-Vandal, 1 Actuator, Flush Actuator Profile, Alcoswitch AVH25

[View on TE.com >](#)

Relays, Contactors & Switches > Switches > Push Button Switches



Configuration (Pole-Throw): **Single Pole - Double Throw**

Push Button Switch Product Type: **Anti-Vandal**

Number of Actuators: **1**

Actuator Profile: **Flush**

Bushing Style: **Threaded**

Features

Product Type Features

Switch Type	Pushbutton
Dust Proof	Yes
Push Button Switch Product Type	Anti-Vandal
Illuminated	Yes
Actuator Style	Flush

Configuration Features

ESD Grounding Terminal	Without
Detent Style	Audible
Ganged	No
Panel Cutout Size	25.2 mm[.99 in]
Configuration (Pole-Throw)	Single Pole - Double Throw
Number of Actuators	1
Snap Action	Without
Support Bracket	Without



Tactile	Yes
---------	-----

Operating Function	On On
--------------------	-------

Electrical Characteristics

Push Button Switch Voltage Rating	250 VAC
-----------------------------------	---------

Body Features

Seal Type	Rubber O-Ring
-----------	---------------

Actuator Force	205 – 510 g[7.2 – 18 oz]
----------------	--------------------------

Case Material	Stainless Steel
---------------	-----------------

Actuator Material	Steel
-------------------	-------

Actuator Profile	Flush
------------------	-------

Bushing Style	Threaded
---------------	----------

Bushing Thread Size	M25 x 1
---------------------	---------

Actuator Color	Silver
----------------	--------

Contact Features

Type of Contact	1 NO & 1 NC
-----------------	-------------

Contact Base Material	Copper Alloy
-----------------------	--------------

Push Button Switch Contact Current Rating	16 A
---	------

Switch Contact Plating Material	Silver
---------------------------------	--------

Termination Features

Termination Type	Wire Lugs
------------------	-----------

Mechanical Attachment

Attachment Method	Screw-On
-------------------	----------

Mounting Angle	Vertical Right Angle
----------------	----------------------

Push Button Switch Mounting Type	Panel
----------------------------------	-------

Housing Features

Low Profile	Yes
-------------	-----

Process Sealed	No
----------------	----

Dimensions

Bushing Diameter	25 mm[.98 in]
------------------	---------------

Bushing Length	17.3 mm[.68 in]
----------------	-----------------

Cap Diameter	19.8 mm[.78 in]
--------------	-----------------

Usage Conditions



Oil-Tight	No
Temperature Rating	Standard

Industry Standards

IP Rating	IP67
-----------	------

Packaging Features

Packaging Method	Loose Piece
------------------	-------------

Product Compliance

[For compliance documentation, visit the product page on TE.com>](#)

EU RoHS Directive 2011/65/EU	Compliant with Exemptions
EU ELV Directive 2000/53/EC	Not Yet Reviewed
China RoHS 2 Directive MIIT Order No 32, 2016	Restricted Materials Above Threshold
EU REACH Regulation (EC) No. 1907/2006	Current ECHA Candidate List: JAN 2023 (233) Candidate List Declared Against: JUNE 2022 (224) Does not contain REACH SVHC
Halogen Content	Low Halogen - Br, Cl, F, I < 900 ppm per homogenous material. Also BFR/CFR/PVC Free
Solder Process Capability	Not reviewed for solder process capability

Product Compliance Disclaimer

This information is provided based on reasonable inquiry of our suppliers and represents our current actual knowledge based on the information they provided. This information is subject to change. The part numbers that TE has identified as EU RoHS compliant have a maximum concentration of 0.1% by weight in homogenous materials for lead, hexavalent chromium, mercury, PBB, PBDE, DBP, BBP, DEHP, DIBP, and 0.01% for cadmium, or qualify for an exemption to these limits as defined in the Annexes of Directive 2011/65/EU (RoHS2). Finished electrical and electronic equipment products will be CE marked as required by Directive 2011/65/EU. Components may not be CE marked. Additionally, the part numbers that TE has identified as EU ELV compliant have a maximum concentration of 0.1% by weight in homogenous materials for lead, hexavalent chromium, and mercury, and 0.01% for cadmium, or qualify for an exemption to these limits as defined in the Annexes of Directive 2000/53/EC (ELV). Regarding the REACH Regulation, the information TE provides on SVHC in articles for this part number is based on the latest European Chemicals Agency (ECHA) 'Guidance on requirements for substances in articles' posted at this URL: <https://echa.europa.eu/guidance-documents/guidance-on-reach>

Compatible Parts



Also in the Series | Alcoswitch AVH25

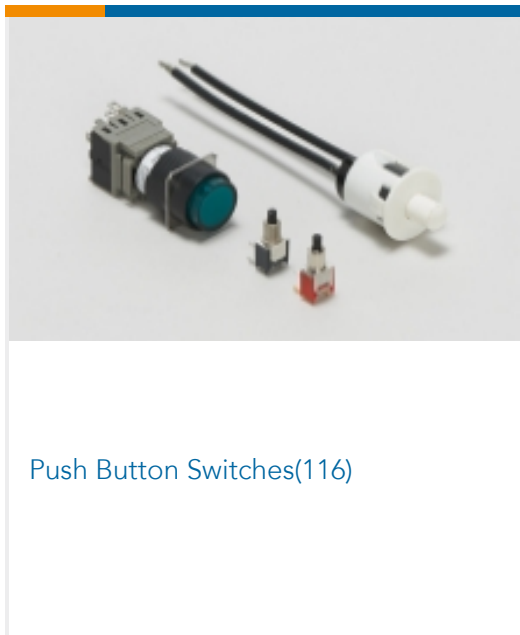

Customers Also Bought

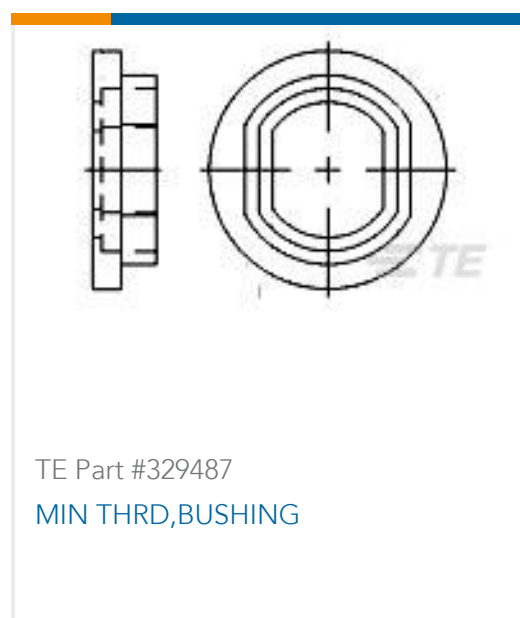

Documents

[CAD Files](#)

[3D PDF](#)

[3D](#)

[Customer View Model](#)

[ENG_CVM_CVM_2-2364700-0_A.2d_dxf.zip](#)

[English](#)



Customer View Model

[ENG_CVM_CVM_2-2364700-0_A.3d_igs.zip](#)

English

Customer View Model

[ENG_CVM_CVM_2-2364700-0_A.3d_stp.zip](#)

English

By downloading the CAD file I accept and agree to the [Terms and Conditions](#) of use.

Datasheets & Catalog Pages

[AVH Series -Anti-Vandal High Current Pushbutton Switches](#)

English