

Guided drives DFM/DFM-B

FESTO



Festo core product range
Covers 80% of your automation tasks

Worldwide:
Superb:
Easy:

Always in stock
Festo quality at an attractive price
Reduces procurement and storing complexity

★ Generally ready for shipping ex works in 24 hours
Held in stock in 13 service centres worldwide
More than 2200 product
★ Generally ready for shipping ex works in 5 days
Assembled for you in 4 service centres worldwide
Up to 6 x 10¹² variants per product series

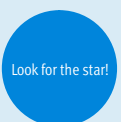

Guided drives DFM/DFM-B

Key features

FESTO

At a glance

Drive and guide unit in a single housing

- Minimal space requirement
- Minimal assembly time
- Choice of supply ports
- Wide range of mounting options

Sturdy and precise

- Good protection against torsion
- High rigidity
- Maintenance-free

High resistance to torques and lateral forces

- With plain-bearing guide: high rigidity thanks to large-diameter guide rods and four plain-bearing bushes
- With recirculating ball bearing guide: for applications involving torque loads

Wide choice of variants

Guided drive DFM

- Basic drive with strokes of up to 200 mm

Guided drive DFM-B

- Drive with strokes of up to 400 mm
- With precision adjustment of end positions
- With pneumatic cushioning, adjustable PPV
- With shock absorber, self-adjusting, progressive

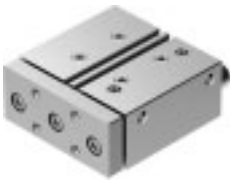

Sample applications

Clamping

The guided drive is perfectly suited to clamping components for reliable further processing.



Lifting

The guided drive effortlessly transports and lifts loads of over 200 kg, powerfully and dynamically.



Stopping

Loads of up to 150 kg are stopped reliably and safely, making the guided drive a resilient and sturdy stopper cylinder.



Guided drives DFM/DFM-B

Key features

Use in conveyor systems

Lifting

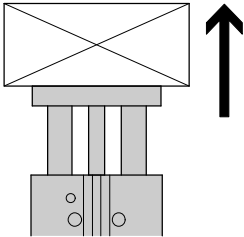

Pushing

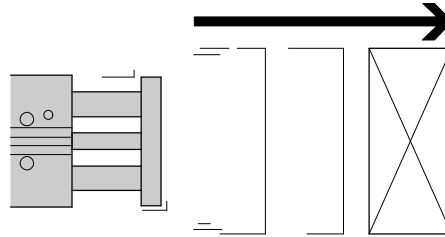

Stopping

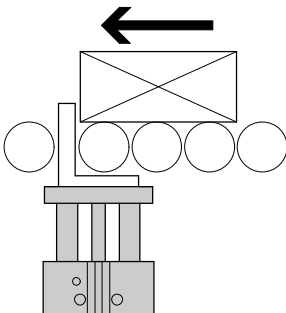

Stopping via stop bracket

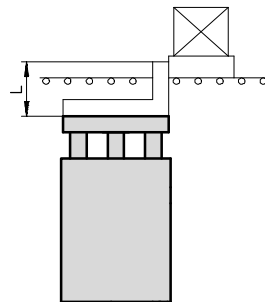

It is recommended to fit a buffer on the workpiece carrier.

Mounting options

Flat from above

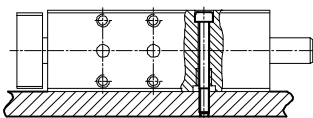

Flat from below

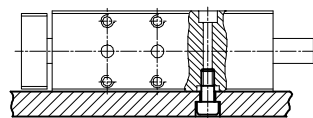

Side from below

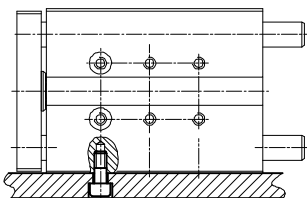

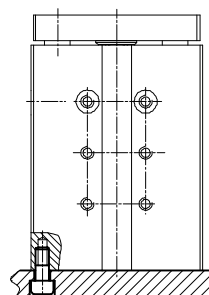

On end

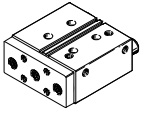
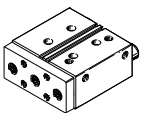
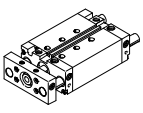
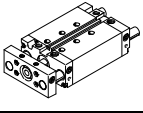

Guided drives DFM/DFM-B

Product range overview

Function	Version	Type	Piston Ø	Stroke	Variable stroke		
			[mm]	[mm]	[mm]		
Double-acting	DFM basic version with recirculating ball bearing guide						
		DFM Piston rod at one end	12, 16	10, 20, 25, 30, 40, 50, 80, 100	–		
			20, 25	20, 25, 30, 40, 50, 80, 100	–		
			32	20, 25, 30, 40, 50, 80, 100, 125, 160, 200	–		
			40, 50, 63, 80, 100	25, 50, 80, 100, 125, 160, 200	–		
	DFM basic version with plain-bearing guide						
		DFM Piston rod at one end	6, 10	5, 10, 15, 20	–		
			12, 16	10, 20, 25, 30, 40, 50, 80, 100	–		
			20, 25	20, 25, 30, 40, 50, 80, 100	–		
			32	20, 25, 30, 40, 50, 80, 100, 125, 160, 200	–		
			40, 50, 63, 80, 100	25, 50, 80, 100, 125, 160, 200	–		
			DFM-B with recirculating ball bearing guide				
				DFM-B Piston rod at one end	12, 16	10, 20, 25, 30, 40, 50, 80, 100, 125, 160, 200	10 ... 200
					20, 25, 32	20, 25, 30, 40, 50, 80, 100, 125, 160, 200, 250, 320, 400	20 ... 400
	40, 50, 63	25, 50, 80, 100, 125, 160, 200, 250, 320, 400			25 ... 400		
			DFM-B with plain-bearing guide				
				DFM-B Piston rod at one end	12, 16	10, 20, 25, 30, 40, 50, 80, 100, 125, 160, 200	10 ... 200
					20, 25, 32	20, 25, 30, 40, 50, 80, 100, 125, 160, 200, 250, 320, 400	20 ... 400
	40, 50, 63	25, 50, 80, 100, 125, 160, 200, 250, 320, 400			25 ... 400		

-  - Note
 Engineering software GSED
 → www.festo.com

Guided drives DFM/DFM-B

Product range overview

Type	Position sensing	Cushioning			Heat-resistant seals	Precision end-position adjustment		→ Page/ Internet
		Not adjustable	Adjustable for heavy loads	Self-adjusting end position adjustable for heavy loads		Advanced end position, elastic cushioning	Retracted end position, elastic cushioning	
	A	P	PPV	YSRW	S6	AJ	EJ	
DFM basic version with recirculating ball bearing guide								
DFM Piston rod at one end	■	■	-	-	-	-	-	8
DFM basic version with plain-bearing guide								
DFM Piston rod at one end	■	■	-	-	-	-	-	8
DFM-B with recirculating ball bearing guide								
DFM-B Piston rod at one end	■	■	■ Ø 16 and above	■ Ø 20 and above	-	■	■ Ø 20 and above	38
DFM-B with plain-bearing guide								
DFM-B Piston rod at one end	■	■	■ Ø 16 and above	-	■	■	■ Ø 20 and above	38

Guided drives DFM

Peripherals overview

FESTO

Piston \varnothing 6, 10

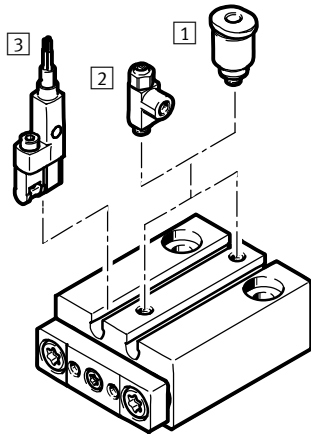

Piston \varnothing 12 ... 100

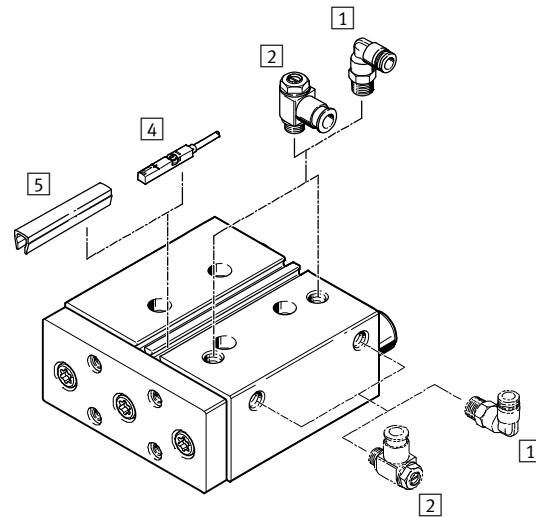

Accessories			
	For piston \varnothing	Description	→ Page/Internet
1	6 ... 100	Push-in fitting QSM/QS For connecting tubing with standard outside diameter	qs
2	6 ... 100	One-way flow control valve GRLA For speed regulation	70
3	6, 10	Proximity sensor SMT-10G Insertable in the slot lengthwise	68
4	12 ... 100	Proximity sensor SME-/SMT-8 Can be integrated in the profile barrel	69
5	12 ... 100	Slot cover ABP-5-S For protecting the sensor cable and keeping dirt out of the sensor slots	70
-	12 ... 100	Centring sleeves ZBH 4 or 6 pieces included in the scope of delivery	68
-	12 ... 100	Adapters For drive/drive connections	71
-	12 ... 100	Adapters For drive/gripper connections	gripper

-  - Note

Only the following push-in fittings/one-way flow control valve may be used in combination with proximity sensors SMT-10G:

- QSM-M3-2...
- QSM-M3-3...
- GRLA-M3

Guided drives DFM

Type codes

DFM – 50 – 80 – P – A –

Type

Double-acting	
DFM	Guided drive

Piston Ø [mm]

Stroke [mm]

Cushioning

P	Elastic cushioning rings/pads at both ends
---	--

Position sensing

A	For proximity sensor
---	----------------------

Guidance

GF	Plain-bearing guide
KF	Recirculating ball bearing guide

High functionality
 Direction of movement

Excellent protection against torsion, high resistance to torques and lateral forces

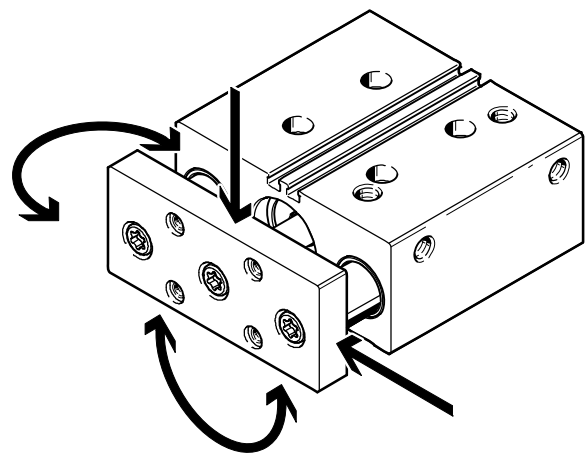
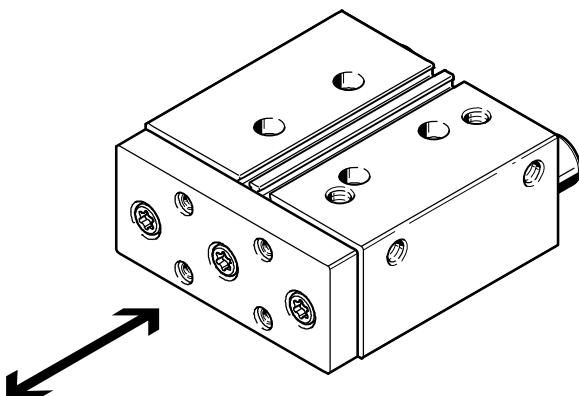

Guided drives DFM

Technical data

FESTO

Function

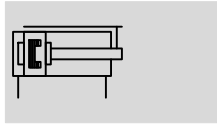

www.festo.com

Piston Ø 12 ... 100 mm

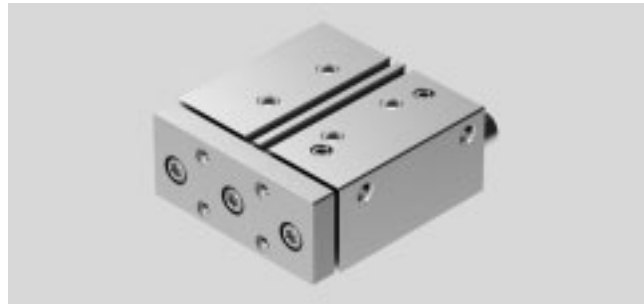

- - Diameter
6 ... 100 mm
- - Stroke length
5 ... 200 mm

General technical data												
Piston Ø	6	10	12	16	20	25	32	40	50	63	80	100
Pneumatic connection	M3	M3	M5	M5	M5	G1/8	G1/8	G1/8	G1/4	G1/4	G3/8	G3/8
Design	Piston											
	Piston rod											
	Guide rods with yoke											
Cushioning	Elastic cushioning rings/pads at both ends											
Position sensing	For proximity sensor											
Type of mounting	Via through-hole											
	Via female thread											
Mounting position	Any											
Protection against torsion/guide	Guide rod with yoke/with plain-bearing or ball bearing guide											

- - Note: This product conforms to ISO 1179-1 and to ISO 228-1

Operating and environmental conditions												
Piston Ø	6	10	12	16	20	25	32	40	50	63	80	100
Operating pressure [bar]	2 ... 8	1.5 ... 8	2 ... 10				1.5 ... 10			1 ... 10	0.5 ... 10	
Operating medium	Compressed air to ISO 8573-1:2010 [7:4:4]											
Note on operating/ pilot medium	Lubricated operation possible (in which case lubricated operation will always be required)											
Ambient temperature ¹⁾												
DFM-...-GF [°C]	-10 ... +60		-20 ... +80									
DFM-...-KF [°C]	-		-5 ... +60									
Corrosion resistance class CRC ²⁾	1											
ATEX	Specified types → www.festo.com											

1) Note operating range of proximity sensors

2) Corrosion resistance class CRC 1 to Festo standard FN 940070

Low corrosion stress. For dry indoor applications or transport and storage protection. Also applies to parts behind covers, in the non-visible interior area, and parts which are covered in the application (e.g. drive trunnions).

Speed [m/s]												
Piston Ø	6	10	12	16	20	25	32	40	50	63	80	100
Cushioning P												
Maximum speed, advancing	1.3	1.7	0.8	0.8	0.8	0.8	0.8	0.8	0.6	0.6	0.4	0.4
Maximum speed, retracting	1.1	1.6	0.8	0.8	0.8	0.8	0.8	0.8	0.6	0.6	0.4	0.4

Guided drives DFM

Technical data

FESTO

Forces [N]												
Piston Ø	6	10	12	16	20	25	32	40	50	63	80	100
Theoretical force at 6 bar, advancing	17	47	68	121	188	295	482	754	1178	1870	3016	4712
Theoretical force at 6 bar, retracting	13	40	51	90	141	247	415	686	1057	1750	2827	4418

Impact energy [J]												
Piston Ø	6	10	12	16	20	25	32	40	50	63	80	100
Max. impact energy in the end positions	0.012	0.035	0.07	0.15	0.20	0.30	0.40	0.70	1.00	1.30	0.75	1.00

Permissible impact velocity

$$v_{\text{perm.}} = \sqrt{\frac{2 \times E_{\text{perm.}}}{m_{\text{Intrinsic}} + m_{\text{Load}}}}$$

Maximum permissible load:

$$m_{\text{Load}} = \frac{2 \times E_{\text{perm.}}}{v^2} - m_{\text{Intrinsic}}$$

$v_{\text{perm.}}$ Permissible impact velocity
 $E_{\text{perm.}}$ Maximum impact energy
 $m_{\text{Intrinsic}}$ Moving mass (drive)
 m_{Load} Moving payload

 Note
 These specifications represent the maximum values that can be achieved. Note the maximum permissible impact energy.

DFM with plain-bearing guide GF												
Stroke [mm]	Piston Ø [mm]											
	6	10	12	16	20	25	32	40	50	63	80	100
Product weight [g]												
5	28	38	–	–	–	–	–	–	–	–	–	–
10	33	45.5	344	444	–	–	–	–	–	–	–	–
15	39.5	53.5	–	–	–	–	–	–	–	–	–	–
20	45	60.5	392	507	769	1256	1793	–	–	–	–	–
25	–	–	411	534	806	1308	1858	2217	3440	4470	6984	11000
30	–	–	435	565	850	1368	1937	–	–	–	–	–
40	–	–	497	710	1070	1515	2095	–	–	–	–	–
50	–	–	544	772	1158	1635	2254	2655	4085	5243	8185	12589
80	–	–	688	960	1422	1993	2808	3261	5013	6287	9743	14699
100	–	–	779	1081	1592	2225	3111	3595	5511	6904	10482	15760
125	–	–	–	–	–	–	3595	4123	6302	7824	11490	17094
160	–	–	–	–	–	–	4149	4736	7205	8906	12910	18980
200	–	–	–	–	–	–	4781	5437	8238	10142	14363	21148
Moving mass [g]												
5	8	13	–	–	–	–	–	–	–	–	–	–
10	9	16	172	221	–	–	–	–	–	–	–	–
15	11.5	18.5	–	–	–	–	–	–	–	–	–	–
20	13	21	186	242	385	650	1020	–	–	–	–	–
25	–	–	193	253	400	669	1049	1228	2026	2471	4141	6301
30	–	–	200	264	415	687	1077	–	–	–	–	–
40	–	–	232	343	552	755	1134	–	–	–	–	–
50	–	–	246	364	582	793	1191	1371	2254	2699	4717	7113
80	–	–	289	428	672	904	1450	1629	2687	3130	5461	8141
100	–	–	318	471	732	979	1564	1743	2870	3313	5734	8523
125	–	–	–	–	–	–	1803	1983	3249	3692	6076	9000
160	–	–	–	–	–	–	2003	2183	3569	4010	6553	9668
200	–	–	–	–	–	–	2232	2411	3935	4375	7099	10431

Guided drives DFM

Technical data



DFM with recirculating ball bearing guide KF										
Stroke [mm]	Piston Ø [mm]									
	12	16	20	25	32	40	50	63	80	100
Product weight [g] (for calculation → page 22)										
10	314	426	–	–	–	–	–	–	–	–
20	357	484	747	1173	1627	–	–	–	–	–
25	375	508	781	1221	1684	2043	3212	4242	6506	10520
30	397	537	822	1278	1755	–	–	–	–	–
40	480	641	981	1411	1896	–	–	–	–	–
50	524	699	1064	1524	2038	2439	3801	4959	7582	11980
80	655	872	1310	1863	2511	2964	4614	5888	8895	13612
100	737	982	1468	2080	2781	3265	5068	6461	9500	14587
125	–	–	–	–	3189	3717	5758	7279	10485	15820
160	–	–	–	–	3684	4271	6583	8283	11750	17545
200	–	–	–	–	4249	4905	7525	9429	13214	21124
Moving mass [g] (for calculation → page 22)										
10	155	212	–	–	–	–	–	–	–	–
20	165	229	376	595	875	–	–	–	–	–
25	170	241	388	611	895	1074	1796	2241	3673	5696
30	175	249	400	626	915	–	–	–	–	–
40	196	294	488	680	955	–	–	–	–	–
50	206	310	512	711	996	1175	1969	2413	4092	6318
80	237	359	584	802	1173	1352	2287	2731	4632	7105
100	257	392	632	863	1254	1433	2425	2868	4837	7406
125	–	–	–	–	1418	1597	2703	3146	5093	7782
160	–	–	–	–	1559	1738	2945	3386	5451	8308
200	–	–	–	–	1720	1899	3221	3660	5861	8910

DFM with recirculating ball bearing guide KF										
Stroke [mm]	Piston Ø [mm]									
	12	16	20	25	32	40	50	63	80	100
Centre of gravity of the moving mass [mm] (for calculation → page 22)										
10	13.6	13.4	–	–	–	–	–	–	–	–
20	15.2	16.5	17.5	24.6	26.3	–	–	–	–	–
25	16.7	19.1	19.1	26.4	28.0	28.2	30.6	27.8	33.9	35.0
30	18.3	20.8	20.8	28.2	29.8	–	–	–	–	–
40	25.3	31.2	34.6	34.9	33.4	–	–	–	–	–
50	29.0	35.2	38.5	38.8	37.1	37.3	39.5	35.8	47.2	48.3
80	40.6	47.8	50.9	50.9	54.7	53.9	57.4	51.9	66.8	67.9
100	48.8	56.5	59.4	59.4	63.0	62.1	65.6	59.4	74.1	75.2
125	–	–	–	–	80.9	79.0	82.8	75.2	84.1	85.2
160	–	–	–	–	96.4	94.4	98.1	89.6	98.4	99.5
200	–	–	–	–	114.6	112.3	115.9	106.5	115.2	116.3

Guided drives DFM

Technical data

Materials

Sectional view

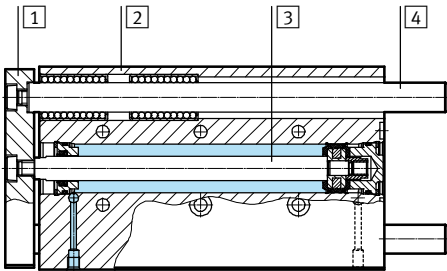

Guided drives		
Piston Ø	6, 10	12 ... 100
1	Yoke plate	Aluminium Tempered steel
2	Housing	Anodised wrought aluminium alloy
3	Piston rod	High-alloy stainless steel
4	Guide rods	
	DFM-...-GF	High-alloy stainless steel
	DFM-...-KF	Hard-chromium plated tempered steel
-	Static seals	Nitrile rubber
	Dynamic seals	Polyurethane, HNBR Polyurethane
	Note on materials	RoHS compliant

Guided drives DFM

Technical data

FESTO

Maximum payload F [N]

Plain-bearing guide GF and recirculating ball bearing guide KF

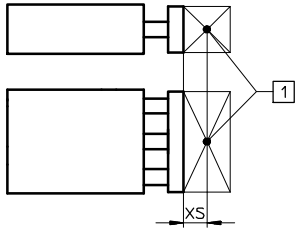

1 Centre of gravity of payload

Piston Ø	6	10	12	16	20	25	32	40	50	63	80	100
XS [mm]	5	5	25	50	50	50	50	50	50	50	125	125

Stroke [mm]		Piston Ø											
		6	10	12	16	20	25	32	40	50	63	80	100
5	GF	1.1	3.7	–	–	–	–	–	–	–	–	–	–
10	GF	0.85	3.0	28	63	–	–	–	–	–	–	–	–
	KF	–	–	28	45	–	–	–	–	–	–	–	–
15	GF	0.7	2.5	–	–	–	–	–	–	–	–	–	–
20	GF	0.6	2.1	24	56	67	121	188	–	–	–	–	–
	KF	–	–	24	41	46	110	155	–	–	–	–	–
25	GF	–	–	23	53	64	116	180	180	257	257	276	452
	KF	–	–	23	39	44	105	149	149	235	235	220	332
30	GF	–	–	21	51	61	112	173	–	–	–	–	–
	KF	–	–	21	37	42	102	144	–	–	–	–	–
40	GF	–	–	31	73	110	123	161	–	–	–	–	–
	KF	–	–	31	82	108	119	135	–	–	–	–	–
50	GF	–	–	28	67	103	115	150	150	216	216	311	509
	KF	–	–	28	77	102	112	126	126	202	202	275	415
80	GF	–	–	22	55	86	96	166	166	234	234	352	568
	KF	–	–	23	64	86	95	151	151	233	233	329	495
100	GF	–	–	19	49	77	86	150	150	212	212	329	533
	KF	–	–	20	58	78	86	138	138	214	214	318	480
125	GF	–	–	–	–	–	–	168	168	229	229	304	494
	KF	–	–	–	–	–	–	161	161	238	238	306	463
160	GF	–	–	–	–	–	–	146	146	200	200	274	446
	KF	–	–	–	–	–	–	143	143	212	212	291	442
200	GF	–	–	–	–	–	–	127	127	174	174	245	400
	KF	–	–	–	–	–	–	127	127	189	189	277	422

Guided drives DFM

Technical data

FESTO

Permitted torque loading M [Nm]

Plain-bearing guide GF and recirculating ball bearing guide KF

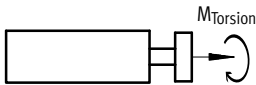

Stroke [mm]		Piston Ø											
		6	10	12	16	20	25	32	40	50	63	80	100
5	GF	0.011	0.057	-	-	-	-	-	-	-	-	-	-
10	GF	0.008	0.046	0.60	1.44	-	-	-	-	-	-	-	-
	KF	-	-	0.88	2.19	-	-	-	-	-	-	-	-
15	GF	0.007	0.039	-	-	-	-	-	-	-	-	-	-
20	GF	0.006	0.034	0.50	1.30	1.85	4.15	7.30	-	-	-	-	-
	KF	-	-	0.72	1.79	2.43	6.14	9.62	-	-	-	-	-
25	GF	-	-	0.48	1.23	1.75	3.95	7.00	7.90	14.15	15.90	21.40	42.40
	KF	-	-	0.66	1.64	2.24	5.77	9.08	10.25	19.35	21.98	17.10	25.70
30	GF	-	-	0.45	1.18	1.70	3.80	6.70	-	-	-	-	-
	KF	-	-	0.61	1.52	2.08	5.43	8.60	-	-	-	-	-
40	GF	-	-	0.65	1.68	3.00	4.20	6.20	-	-	-	-	-
	KF	-	-	0.81	2.92	4.64	5.94	7.77	-	-	-	-	-
50	GF	-	-	0.60	1.56	2.80	3.90	5.80	6.55	11.85	13.30	24.20	47.80
	KF	-	-	0.73	2.63	4.23	5.43	7.09	8.00	15.51	17.62	21.30	32.20
80	GF	-	-	0.45	1.28	2.35	3.25	6.40	7.25	12.85	14.45	27.20	53.40
	KF	-	-	0.56	2.03	3.36	4.33	7.71	8.70	16.43	18.67	25.50	38.40
100	GF	-	-	0.40	1.14	2.10	2.90	5.80	6.55	11.65	13.10	25.50	50.10
	KF	-	-	0.48	1.77	2.95	3.81	6.86	7.74	14.76	16.77	24.70	37.20
125	GF	-	-	-	-	-	-	6.50	7.35	12.55	14.10	23.50	46.40
	KF	-	-	-	-	-	-	7.66	8.64	15.77	17.92	23.70	35.90
160	GF	-	-	-	-	-	-	5.70	6.40	11.00	12.30	21.30	42.00
	KF	-	-	-	-	-	-	6.64	7.49	13.78	15.66	22.60	34.20
200	GF	-	-	-	-	-	-	5.00	5.55	9.60	10.70	19.00	37.60
	KF	-	-	-	-	-	-	5.76	6.50	12.04	13.68	21.50	32.70

Note
Engineering software GSED
→ www.festo.com

Guided drives DFM

Technical data



Torsional backlash ρ

Plain-bearing guide GF and recirculating ball bearing guide KF in retracted state, without load

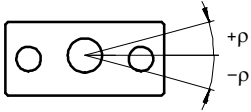

Piston \varnothing		6	10	12	16	20	25	32	40	50	63	80	100
Average torsional backlash [°]	GF	±0.1	±0.1	±0.06	±0.06	±0.05	±0.04	±0.04	±0.03	±0.03	±0.02	±0.03	±0.03
Torsional backlash [°]	KF	-	-	±0.03	±0.02	±0.02	±0.02	±0.01	±0.01	±0.02	±0.02	±0.03	±0.03

Deflection of end plate

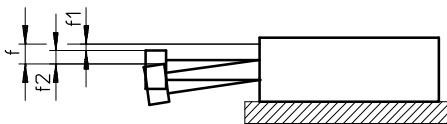

$$f = f_1 + f_2$$

f = Total deflection of end plate

f_1 = Deflection due to average bearing clearance (GF)/bearing clearance (KF)

Bearing clearance GF with production tolerance ± 0.01 mm

Bearing clearance KF determined through series of tests

f_2 = Deflection due to lateral force

Deflection f_1 due to bearing clearance as a function of stroke l (with no load)

1 bearing per guide rod

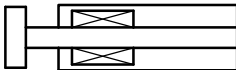

GF: DFM-6/10 all strokes

DFM-16/20 Stroke ≤ 30 mm

KF: DFM-12/16/20 Stroke ≤ 30 mm

2 bearings per guide rod

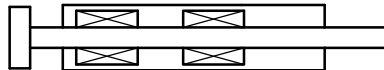

GF: DFM-12 Stroke ≤ 30 mm

GF+KF: DFM-12/16/20 Stroke ≥ 40 mm

DFM-25 ... 100 all strokes

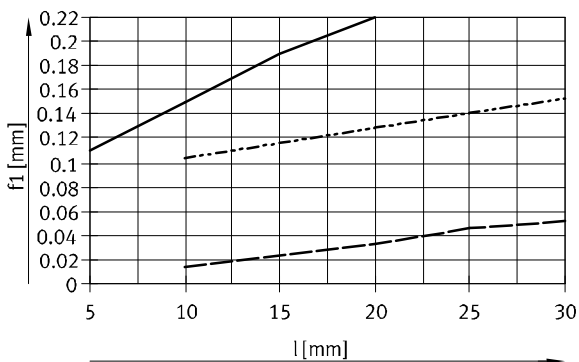

— Plain-bearing guide GF (average deflection f_1) for $\varnothing 6/10$
 - - - Plain-bearing guide GF (average deflection f_1) for $\varnothing 12 \dots 100$
 - - - Recirculating ball bearing guide KF

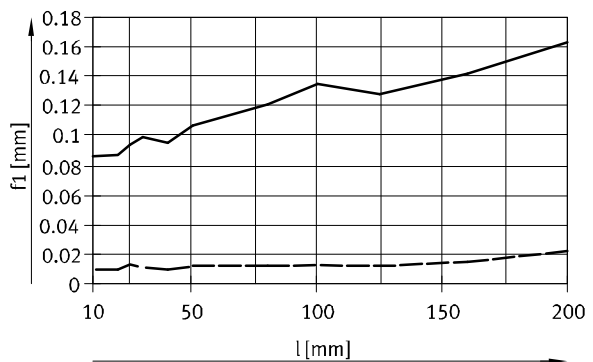

— Plain-bearing guide GF (average deflection f_1)
 - - - Recirculating ball bearing guide KF

Guided drives DFM

Technical data

Use as a stopper cylinder

When used as a stopper cylinder, only guided drives with plain-bearing guide DFM-...-GF may be used.

In addition, the distance l_{max} (→ drawing) must not be exceeded.

The permissible kinetic impact energy at the end stop must also not be exceeded.

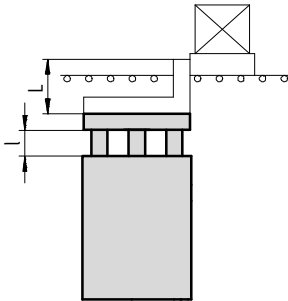

$$l_{max} = \text{Stroke } l + \text{height of stop bracket } L$$

$$l_{max} = 50 \text{ mm}$$

Impact load m as a function of the impact velocity v

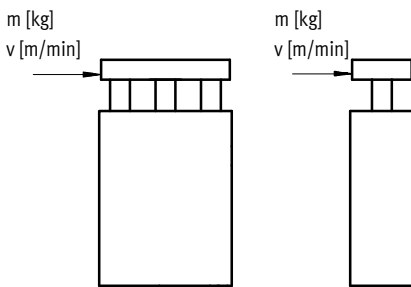

DFM-12 ... 25-GF, stroke < 30 mm

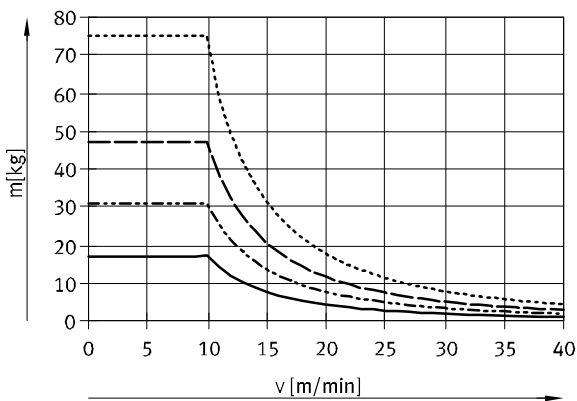

- DFM-12
- - - DFM-16
- DFM-20
- - - DFM-25

The values in the above graph are based on the assumption that the workpiece carrier is fitted with a flexible buffer with a deformation of 1mm. Only guided drives with a plain-bearing guide GF < 30 mm stroke may be used.

DFM-32 ... 100-GF, stroke < 50 mm

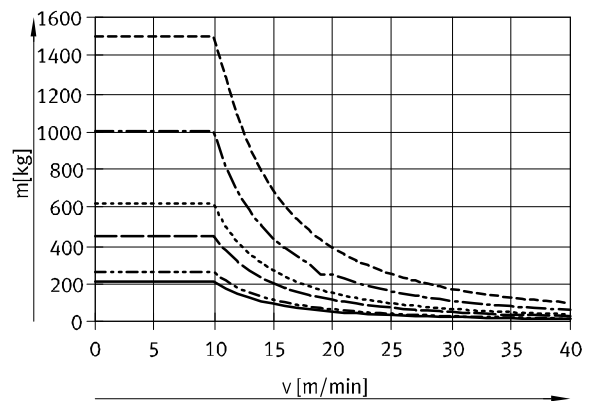

- DFM-32
- - - DFM-40
- DFM-50
- - - DFM-63
- DFM-80
- - - DFM-100

The values in the above graph are based on the assumption that the workpiece carrier is fitted with a flexible buffer with a deformation of 2mm. Only guided drives with a plain-bearing guide GF < 50 mm stroke may be used.

Guided drives DFM

Technical data



Used as a lifting cylinder

Permissible load with plain-bearing guide GF

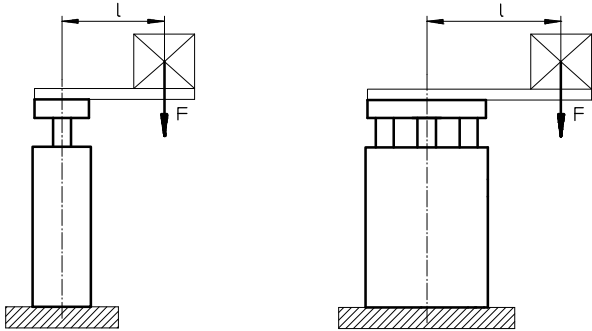

F = Lateral force [N]
l = Lever arm [mm]

DFM-12 ... 25-GF, stroke up to 30 mm

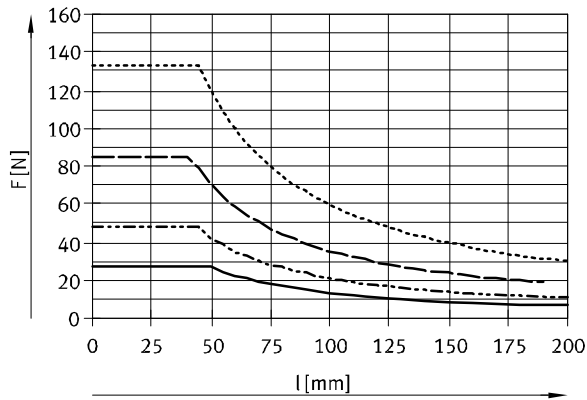

— DFM-12
- - - DFM-16
- · - DFM-20
· · · DFM-25

DFM-12 ... 25-GF, stroke 40 ... 100 mm

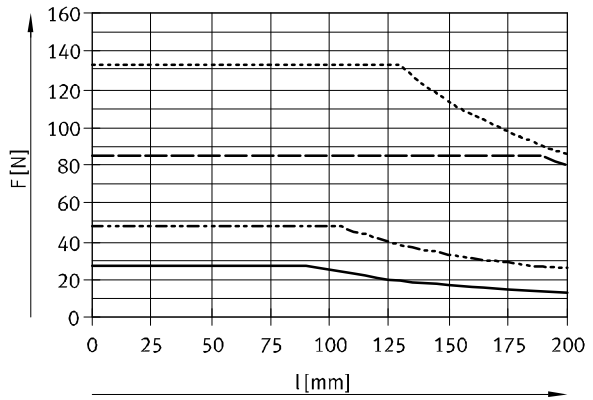

— DFM-12
- - - DFM-16
- · - DFM-20
· · · DFM-25

DFM-32 ... 63-GF, stroke up to 50 mm

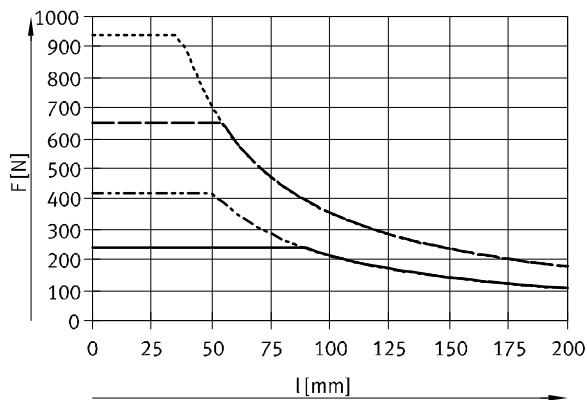

— DFM-32
- - - DFM-40
- · - DFM-50
· · · DFM-63

DFM-32 ... 63-GF, stroke 80 ... 100 mm

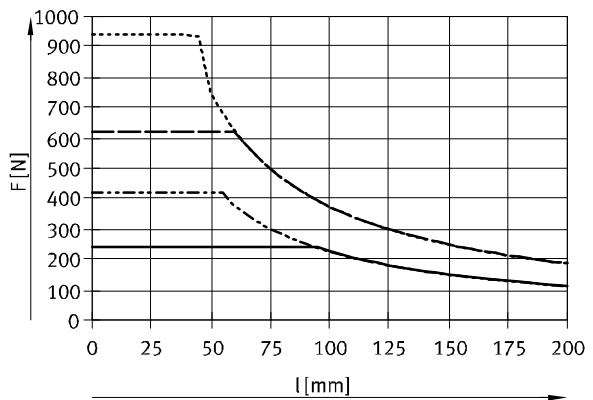

— DFM-32
- - - DFM-40
- · - DFM-50
· · · DFM-63

Guided drives DFM

Technical data

Used as a lifting cylinder

Permissible load with plain-bearing guide GF

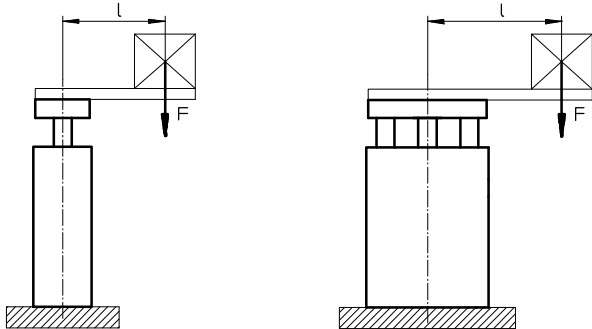

F = Lateral force [N]
l = Lever arm [mm]

DFM-32 ... 63-GF, stroke 125 ... 200 mm

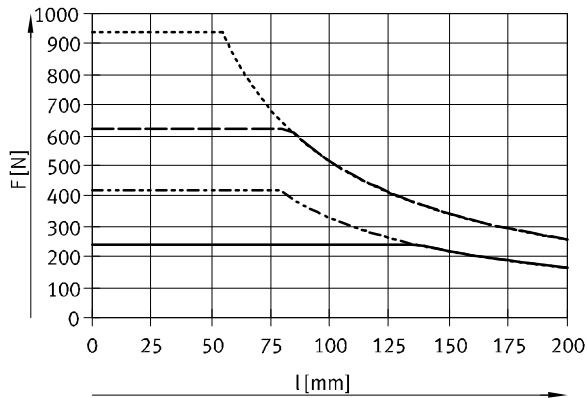

- DFM-32
- - - DFM-40
- · - DFM-50
- · · - DFM-63

DFM-80 ... 100-GF, stroke 25 mm

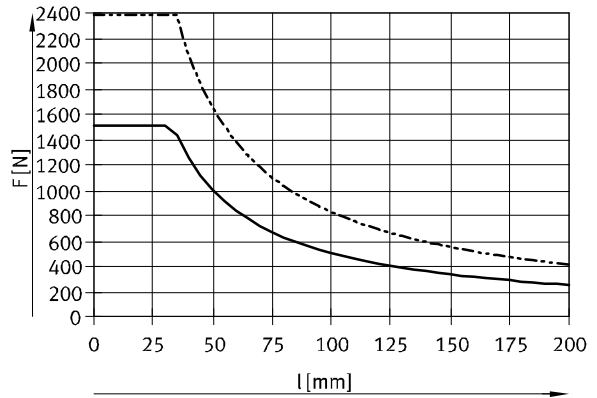

- DFM-80
- - - DFM-100

DFM-80 ... 100-GF, stroke 50 mm

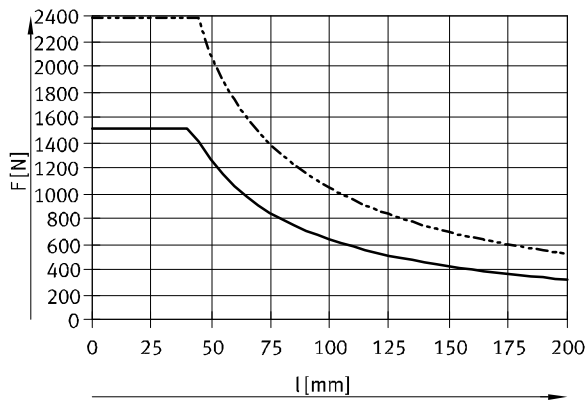

- DFM-80
- - - DFM-100

DFM-80 ... 100-GF, stroke 80 ... 200 mm

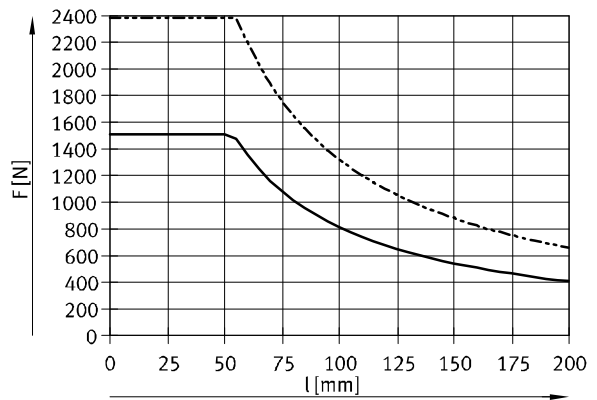

- DFM-80
- - - DFM-100

Guided drives DFM

Technical data



Used as a lifting cylinder

Permissible load with recirculating ball bearing guide KF

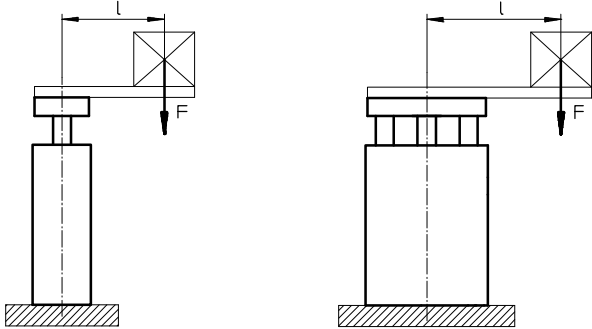

F = Lateral force [N]
l = Lever arm [mm]

DFM-12 ... 25-KF, stroke up to 30 mm

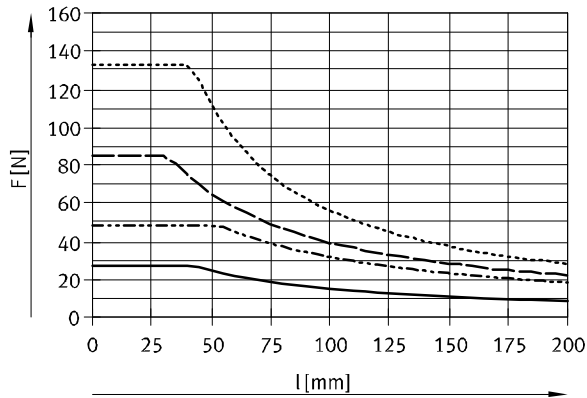

— DFM-12
- - - DFM-16
- · - DFM-20
· · · DFM-25

DFM-12 ... 25-KF, stroke 40 ... 100 mm

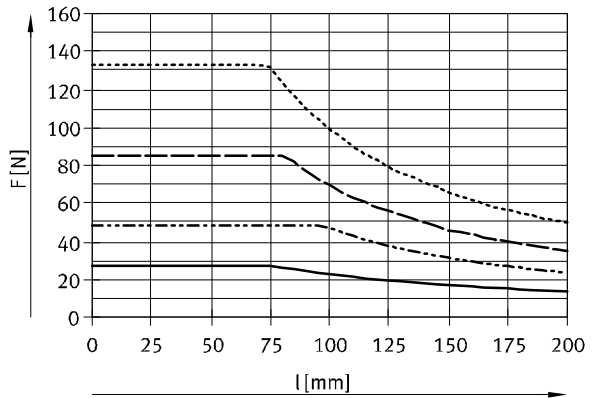

— DFM-12
- - - DFM-16
- · - DFM-20
· · · DFM-25

DFM-32 ... 63-KF, stroke up to 50 mm

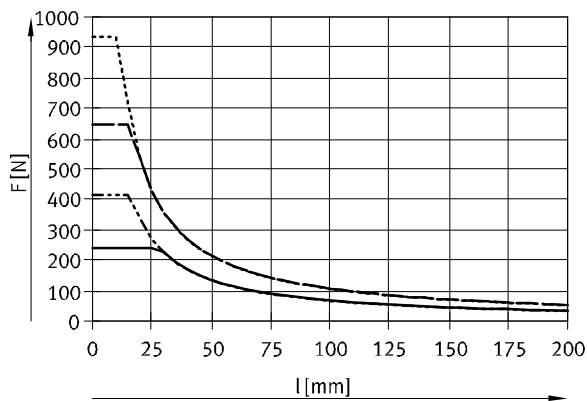

— DFM-32
- - - DFM-40
- · - DFM-50
· · · DFM-63

DFM-32 ... 63-KF, stroke 80 ... 100 mm

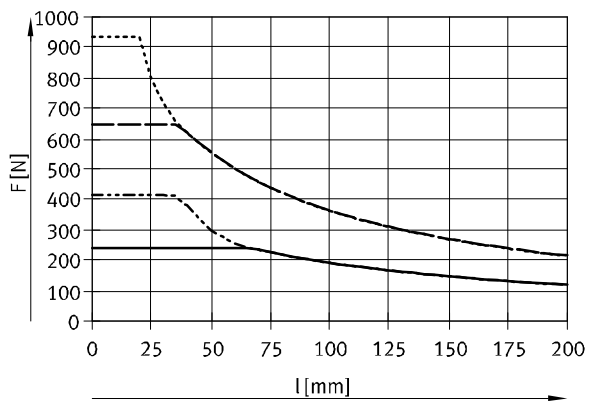

— DFM-32
- - - DFM-40
- · - DFM-50
· · · DFM-63

Guided drives DFM

Technical data

Used as a lifting cylinder

Permissible load with recirculating ball bearing guide KF

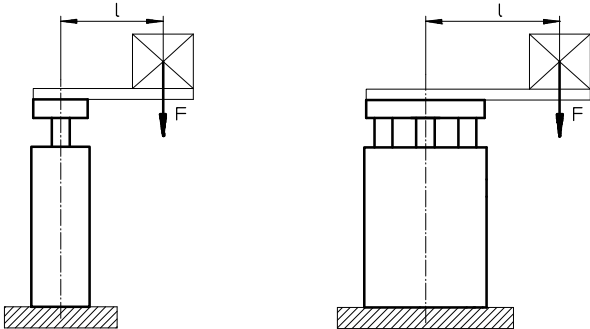

F = Lateral force [N]
l = Lever arm [mm]

DFM-32 ... 63-KF, stroke 125 ... 200 mm

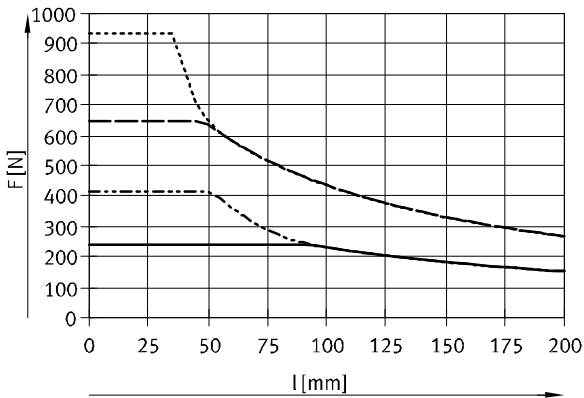

- DFM-32
- - - DFM-40
- · - DFM-50
- · · - DFM-63

DFM-80 ... 100-KF, stroke 25 mm

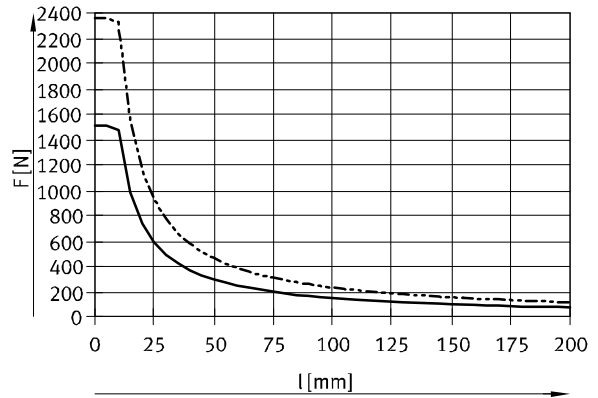

- DFM-80
- - - DFM-100

DFM-80 ... 100-KF, stroke 50 mm

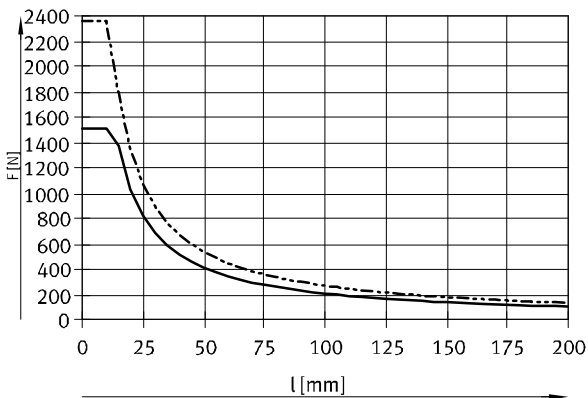

- DFM-80
- - - DFM-100

DFM-80 ... 100-KF, stroke 80 ... 200 mm

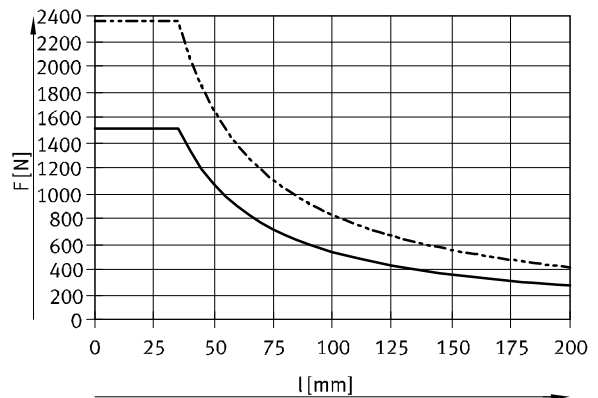

- DFM-80
- - - DFM-100

Guided drives DFM

Technical data



Characteristic load values for recirculating ball bearing guide KF

The indicated forces and torques refer to the guide centre.

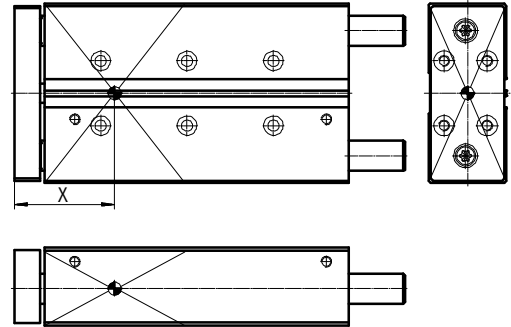
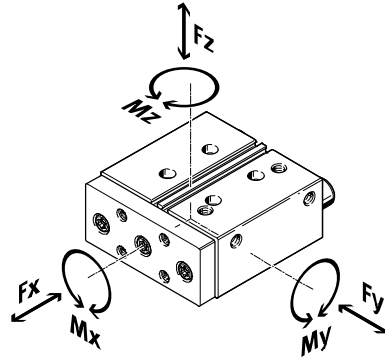

If the guided drive is subjected to two or more of the indicated forces and torques simultaneously, the following equation must be satisfied in addition to the indicated maximum loads:

Calculating the load comparison factor:

$$f_v = \frac{|F_{y,dyn}|}{F_{y,max}} + \frac{|F_{z,dyn}|}{F_{z,max}} + \frac{|M_{x,dyn}|}{M_{x,max}} + \frac{|M_{y,dyn}|}{M_{y,max}} + \frac{|M_{z,dyn}|}{M_{z,max}} \leq 1$$

Distance X (for calculation → page 22)

Piston Ø	Stroke [mm]	Dimension X [mm]	Piston Ø	Stroke [mm]	Dimension X [mm]
12	10 ... 30	26.1	40	25 ... 50	47.5
	40 ... 100	35.3		80 ... 100	56.5
16	10 ... 30	25.5		125 ... 200	66.5
	40 ... 100	38.5	50	25 ... 50	54.5
20	20 ... 30	28.5		80 ... 100	65
	40 ... 100	46.5		125 ... 200	75
25	20 ... 30	42.5	63	25 ... 50	54.5
	40 ... 100	47.5		80 ... 100	65
32	20 ... 50	47.5		125 ... 200	75
	80 ... 100	56.5	80	25	66.5
	125 ... 200	66.5		50	77
100				80 ... 200	92
			25	73	
			50	84	
			80 ... 200	99	

Guided drives DFM

Technical data



Max. permissible forces and torques for recirculating ball bearing guide KF

The indicated forces and torques refer to the guide centre.

Piston \varnothing	Stroke [mm]	Static			Dynamic (for a service life of 10000 km)		
		F _y max./F _z max. [N]	M _x max. [Nm]	M _y max./M _z max. [Nm]	F _y max./F _z max. [N]	M _x max. [Nm]	M _y max./M _z max. [Nm]
12	10 ... 30	355	7.28	3.2	193	3.95	1.74
	40 ... 100	804	16.48	8.44	292	5.99	3.07
16	10 ... 30	415	9.55	4.15	389	8.95	3.89
	40 ... 100	830	19.09	11.2	778	17.9	10.5
20	20 ... 30	510	14.79	5.61	408	11.84	4.49
	40 ... 100	1020	29.58	18.87	817	23.69	15.11
25	20 ... 30	1060	36.04	15.37	863	29.35	12.52
	40 ... 100	1060	36.04	20.67	863	29.35	16.83
32	20 ... 50	1260	49.14	20.79	1130	44.09	18.66
	80 ... 100	1260	49.14	32.13	1130	44.09	28.83
	125 ... 200	1260	49.14	44.73	1130	44.09	40.13
40	25 ... 50	1260	55.44	20.79	1130	49.74	18.66
	80 ... 100	1260	55.44	32.13	1130	49.74	28.83
	125 ... 200	1260	55.44	44.73	1130	49.74	40.13
50	25 ... 50	1600	88	34.4	1487	81.79	31.98
	80 ... 100	1600	88	51.2	1487	81.79	47.58
	125 ... 200	1600	88	67.2	1487	81.79	62.46
63	25 ... 50	1600	100	34.4	1487	92.97	31.98
	80 ... 100	1600	100	51.2	1487	92.97	47.58
	125 ... 200	1600	100	67.2	1487	92.97	62.46
80	25	3120	241.8	73.32	2048	158.67	48.12
	50	3120	241.8	106.1	2048	158.67	69.62
	80 ... 200	3120	241.8	152.9	2048	158.67	100.35
100	25	5400	507.6	135	3043	286.02	76.06
	50	5400	507.6	194.4	3043	286.02	109.53
	80 ... 200	5400	507.6	275.4	3043	286.02	155.16

Guided drives DFM

Technical data

Calculating the service life for recirculating ball bearing guide KF

The service life of the guide depends on the load. To provide a rough indication of the service life of the guide, the graph below plots the load comparison factor f_v against the service life ratio q .

These values are only theoretical. You must consult your local contact person at Festo for load comparison factors f_v greater than 1.5.

Load comparison factor f_v as a function of service life ratio q

Example:

The effect on the service life, deviating from the specified reference service life, can be determined by the service life ratio q :

Given:

Reference service life = 10000 km

Required service life = 3000 km

$$q = \frac{3000\text{km}}{10000\text{km}} = 0.3$$

The graph gives a load comparison factor f_v of 1.5. This means that the permissible total load can be utilised up to 150%.

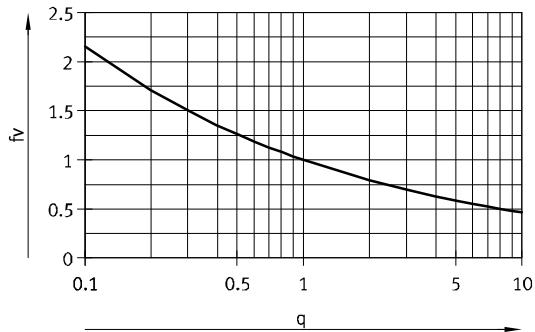

Note
PositioningDrives
engineering software
www.festo.com

$f_v > 1.5$ are only theoretical comparison values.

Calculation example

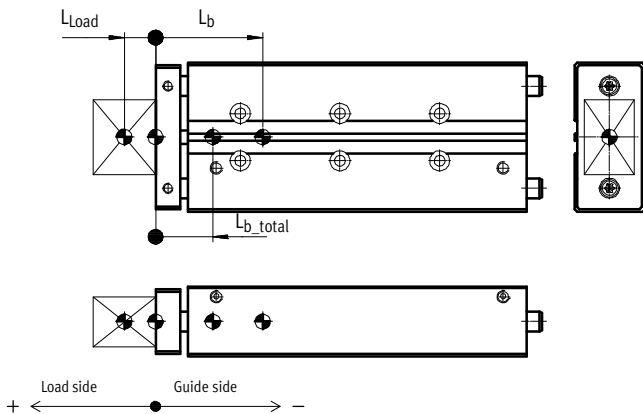

- L_b = Centre of gravity of the moving mass of the guided drive
- L_{Load} = Centre of gravity of the payload
- L_{b_total} = Centre of gravity of the entire moving mass

Length measurements should be provided with plus/minus signs as shown in the figure:

- $L_{b_total} > 0$ = Centre of gravity of the moving mass is on the payload side
- $L_{b_total} < 0$ = Centre of gravity of the moving mass is on the guide side

Given:

- Guided drive: DFM-32-80-KF
- Stroke length: $H = 80$ mm
- Centre of gravity of payload: $L_{Load} = 35$ mm
- Payload: $m_{Load} = 10$ kg
- Acceleration: $a_x = 2$ m/s², $a_y = a_z = 0$ m/s²

To be calculated:

- Loads F_{y_dyn}/F_{z_dyn} and $M_{x_dyn}/M_{y_dyn}/M_{z_dyn}$
- Verification of operation with combined load
- Expected service life

Guided drives DFM

Technical data

FESTO

Calculation example

Solution:

Moving mass:

$$m_{b_total} = m_b + m_{Load}$$

From table → page 10

$$m_b = 1.173 \text{ kg}$$

$$m_{b_total} = 1.173 \text{ kg} + 10 \text{ kg} = 11.173 \text{ kg}$$

m_b = Moving mass of guided drive

m_{Load} = Payload

Centre of gravity of the moving mass

$$L_{b_total} = \frac{L_{Load} \times m_{Load} + L_b \times m_b}{m_{b_total}}$$

From table → page 10

$$L_b = 54.7 \text{ mm}$$

$$L_{b_total} = \frac{(+ 35 \text{ mm}) \times 10 \text{ kg} + (- 54.7 \text{ mm}) \times 1.173 \text{ kg}}{11.173 \text{ kg}} = 25.6 \text{ mm}$$

L_b = Centre of gravity of the moving mass of the guided drive

m_b = Moving mass of guided drive

L_{Load} = Centre of gravity of the payload

m_{Load} = Payload

Length measurements should be provided with plus/minus signs as shown in the figure:

$L_{b_total} > 0$ = Centre of gravity of the moving mass is on the payload side

$L_{b_total} < 0$ = Centre of gravity of the moving mass is on the guide side

Loads F_{y_dyn}/F_{z_dyn} and $M_{x_dyn}/M_{y_dyn}/M_{z_dyn}$

$$F_{y_dyn} = m_{b_total} \times a_y = 11.173 \text{ kg} \times 0 \text{ m/s}^2 = 0 \text{ N}$$

$$F_{z_dyn} = m_{b_total} \times (g + a_z) = 11.173 \text{ kg} \times (9.81 \text{ m/s}^2 + 0 \text{ m/s}^2) = 110 \text{ N}$$

From table → page 20

$$\text{Dimension X} = 56.5 \text{ mm}$$

$$M_{y_dyn} = F_{z_dyn} \times (\text{dimension X} + \text{stroke} + L_{b_total}) = 110 \text{ N} \times (56.5 \text{ mm} + 80 \text{ mm} + 25.6 \text{ mm}) = 17.8 \text{ Nm}$$

$$M_{z_dyn} = F_{y_dyn} \times (\text{dimension X} + \text{stroke} + L_{b_total}) = 0 \text{ N} \times (56.5 \text{ mm} + 80 \text{ mm} + 25.6 \text{ mm}) = 0 \text{ Nm}$$

Verification of operation with combined load

Max values from table → page 21

$$F_{y_max} = 1130 \text{ N} \quad M_{x_max} = 44.09 \text{ Nm}$$

$$F_{z_max} = 1130 \text{ N} \quad M_{y_max} = 28.83 \text{ Nm}$$

$$M_{z_max} = 28.83 \text{ Nm}$$

$$f_v = \frac{|F_y|}{F_{y,max}} + \frac{|F_z|}{F_{z,max}} + \frac{|M_x|}{M_{x,max}} + \frac{|M_y|}{M_{y,max}} + \frac{|M_z|}{M_{z,max}} \leq 1$$

$$f_v = \frac{0 \text{ N}}{1130 \text{ N}} + \frac{110 \text{ N}}{1130 \text{ N}} + \frac{0 \text{ Nm}}{44.09 \text{ Nm}} + \frac{17.8 \text{ Nm}}{28.83 \text{ Nm}} + \frac{0 \text{ Nm}}{28.83 \text{ Nm}} = 0.72 \leq 1$$

Expected service life

$$L_{calc} = \frac{L_{ref}}{f_v^3} = \frac{10000 \text{ km}}{0.72^3} = 27000 \text{ km}$$

Guided drives DFM

Technical data

Dimensions

Download CAD data → www.festo.com

∅ 6, 10 mm

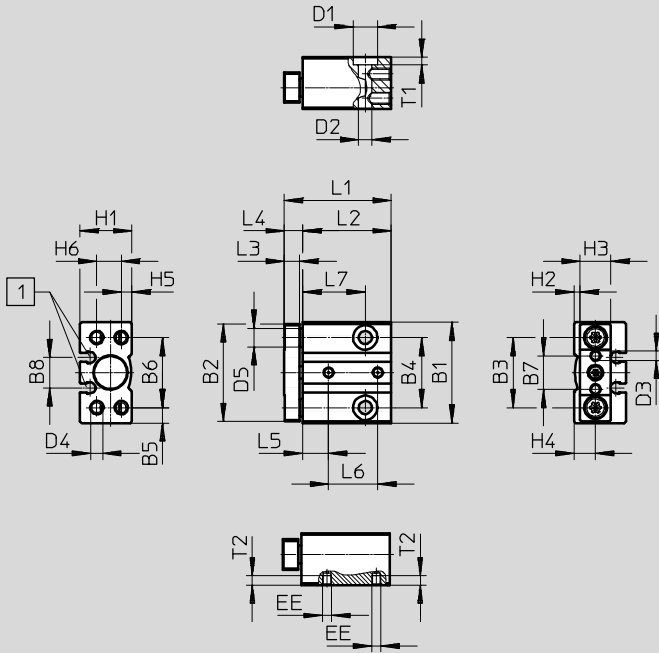

1 Mounting slot for proximity sensor SMT-10G

Guided drives DFM

Technical data

∅ [mm]	B1	B2	B3	B4	B5	B6	B7	B8	D1 ∅	D2 ∅
6	29	28	20.5	20.5	4.3	20.5	9	9.7	6.2	3.3
10	33	32	23	23	5	23	11	10	8	4.3

∅ [mm]	D3	D4	D5 ∅ h8	EE	H1	H2	H3	H4	H5	H6
6	M2.5	M3	5	M3	14.5	1.8	9	6.3	3	6
10	M3	M4	6	M3	17	2	10	7	3.5	8

∅ [mm]	Stroke [mm]	L1	L2	L3	L4	L5	L6	L7	T1	T2
6	5	28	23.5	3.5	4.5	7	12	14	3	3
	10	33	28.5				17	19		
	15	38	33.5				22	24		
	20	43	38.5				27	29		
10	5	30	24	5	6	8.5	11.1	15.5	2.5	3
	10	35	29				16.1	20.5		
	15	40	34				21.1	25.5		
	20	45	39				26.1	30.5		

Guided drives DFM

Technical data

FESTO

Dimensions

Ø 12 ... 16 mm

Download CAD data → www.festo.com

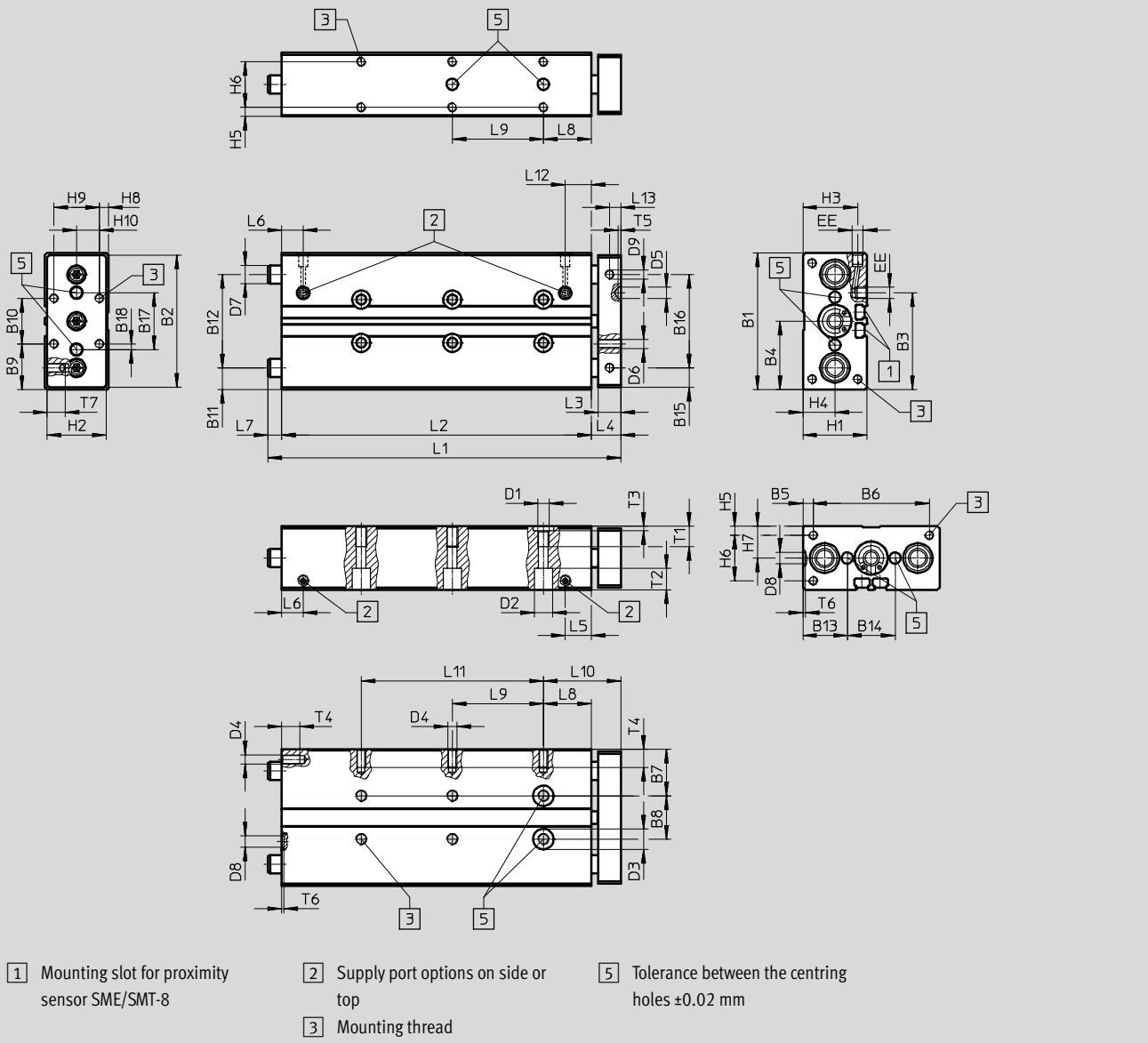

-  Note

If the guide rods project beyond the housing when the unit is in its retracted end position (→ dimension L7), a recess must be provided in the mounting surface if the unit is to be mounted on the end face so that the guide rods can move freely.

Guided drives DFM

Technical data



∅ [mm]	B1	B2	B3	B4	B5	B6	B7	B8	B9	B10	B11	B12	B13	B14	B15	B16	B17	B18	D1	D2 ∅
12	60	58	42.4	30	4.5	51	20.5	19	20	20	9.5	41	19.5	21	8.5	41	25	2.5	M5	8
16	67	65	45.9	33.5	4.5	58	22	23	23.5	20	10.5	46	21.3	24.4	-	-	28	4	M5	7.5

∅ [mm]	D3 ∅ H7	D4	D5 ∅ H7	D6	D7 ∅		D8 ∅ H7	D9	EE	H1	H2	H3	H4	H5	H6	H7	H8	H9	H10
					GF	KF													
12	9	M4	5	M4	10 _{h8}	8 _{h7}	5	M4	M5	28	26	24	14	4	20	14	4	20	10
16	9	M5	5	M5	12 _{h8}	10 _{h7}	5	-	M5	32	30	26.5	16	4	24	16	7.4	20	10

∅ [mm]	Stroke [mm]	L1	L2	L3	L4	L5	L6	L7	L8	L9	L10
12	10	59	46	10	13	11.4	9.5	-	21	-	34
	20	69	56					-		-	
	25	74	61					-		20	
	30	79	66					-		20	
	40	95	76					6		20	
	50	105	86					6		40	
	80	135	116					6		40	
	100	155	136					6		40	
16	10	60	48	10	12	11.9	10.6	-	22	-	34
	20	70	58					-		-	
	25	75	63					-		20	
	30	80	68					-		20	
	40	107	78					17		20	
	50	117	88					17		40	
	80	147	118					17		40	
	100	167	138					17		40	

∅ [mm]	Stroke [mm]	L11	L12	L13	T1	T2	T3	T4	T5	T6	T7
12	10	-	11.4	5	9	9.4	2.1	8	1.2	1	8
	20	-									
	25	-									
	30	-									
	40	-									
	50	-									
	80	-									
	100	80									
16	10	-	11.9	-	9	4.6	2.1	10	1.2	1	-
	20	-									
	25	-									
	30	-									
	40	-									
	50	-									
	80	-									
	100	80									

Guided drives DFM

Technical data

FESTO

Dimensions

∅ 20 ... 25 mm

Download CAD data → www.festo.com

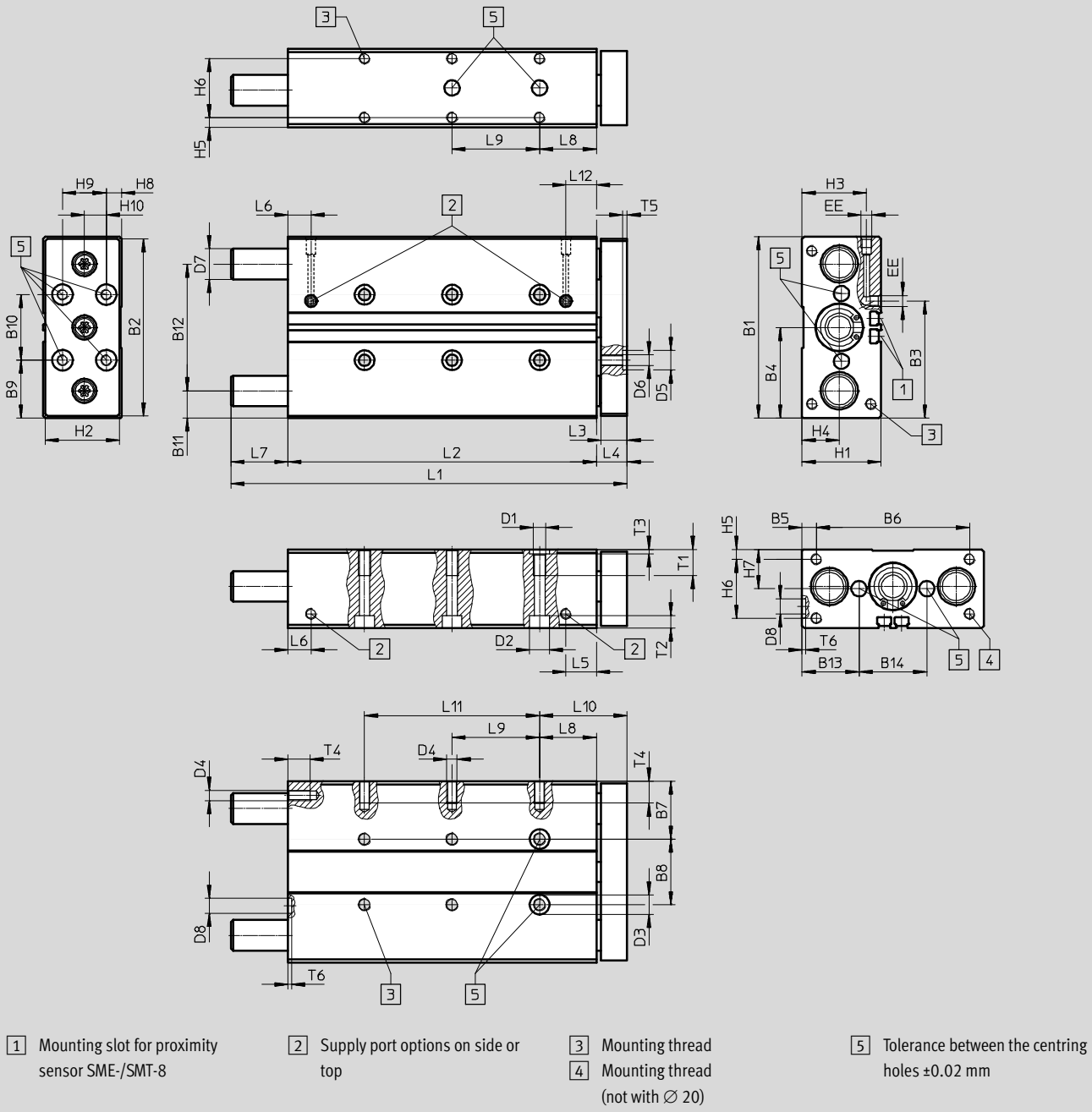

- - Note

If the guide rods project beyond the housing when the unit is in its retracted end position (→ dimension L7), a recess must be provided in the mounting surface if the unit is to be mounted on the end face so that the guide rods can move freely.

Guided drives DFM

Technical data

FESTO

∅ [mm]	B1	B2	B3	B4	B5	B6	B7	B8	B9	B10	B11	B12	B13	B14	D1	D2 ∅	D3 ∅ H7	D4
20	83	81	53.6	41.5	6.5	70	26.5	30	26.5	30	12.5	58	26	31	M6	9	9	M5
25	95	93	70	47.5	15.5	64	30	35	27.5	40	13.5	68	29	37	M6	9	9	M6

∅ [mm]	D5 ∅ H7	D6	D7 ∅		D8 ∅ H7	EE	H1	H2	H3	H4	H5	H6	H7	H8	H9	H10
			GF	KF												
20	9	M5	14 _{h8}	12 _{h7}	7	M5	36	34	29.5	17	4.5	27	18	7	20	10
25	9	M6	16 _{h8}	14 _{h7}	7	G1/8	44	42	34.8	19	4.5	35	22	12	20	10

∅ [mm]	Stroke [mm]	L1	L2	L3	L4	L5	L6	L7	L8	L9
20	20	75	61	12	14	14	10.5	-	26	-
	25	80	66					-		20
	30	85	71					-		20
	40	121	81					26		20
	50	131	91					26		40
	80	161	121					26		40
	100	181	141					26		40
25	20	93	65.6	12	14	17.5	9.5	13.4	26	-
	25	98	70.6					13.4		20
	30	103	75.6					13.4		20
	40	123	85.6					23.4		20
	50	133	95.6					23.4		40
	80	163	125.6					23.4		40
	100	183	145.6					23.4		40

∅ [mm]	Stroke [mm]	L10	L11	L12	T1	T2	T3	T4	T5	T6
20	20	40	-	14	12	5.7	2.1	10	2.1	1.6
	25		-							
	30		-							
	40		-							
	50		-							
	80		-							
	100		80							
25	20	40	-	15	14	5.7	2.1	12	2.1	1.6
	25		-							
	30		-							
	40		-							
	50		-							
	80		-							
	100		80							

- | - Note: This product conforms to ISO 1179-1 and to ISO 228-1

Guided drives DFM

Technical data

FESTO

Dimensions

∅ 32 ... 63 mm

Download CAD data → www.festo.com

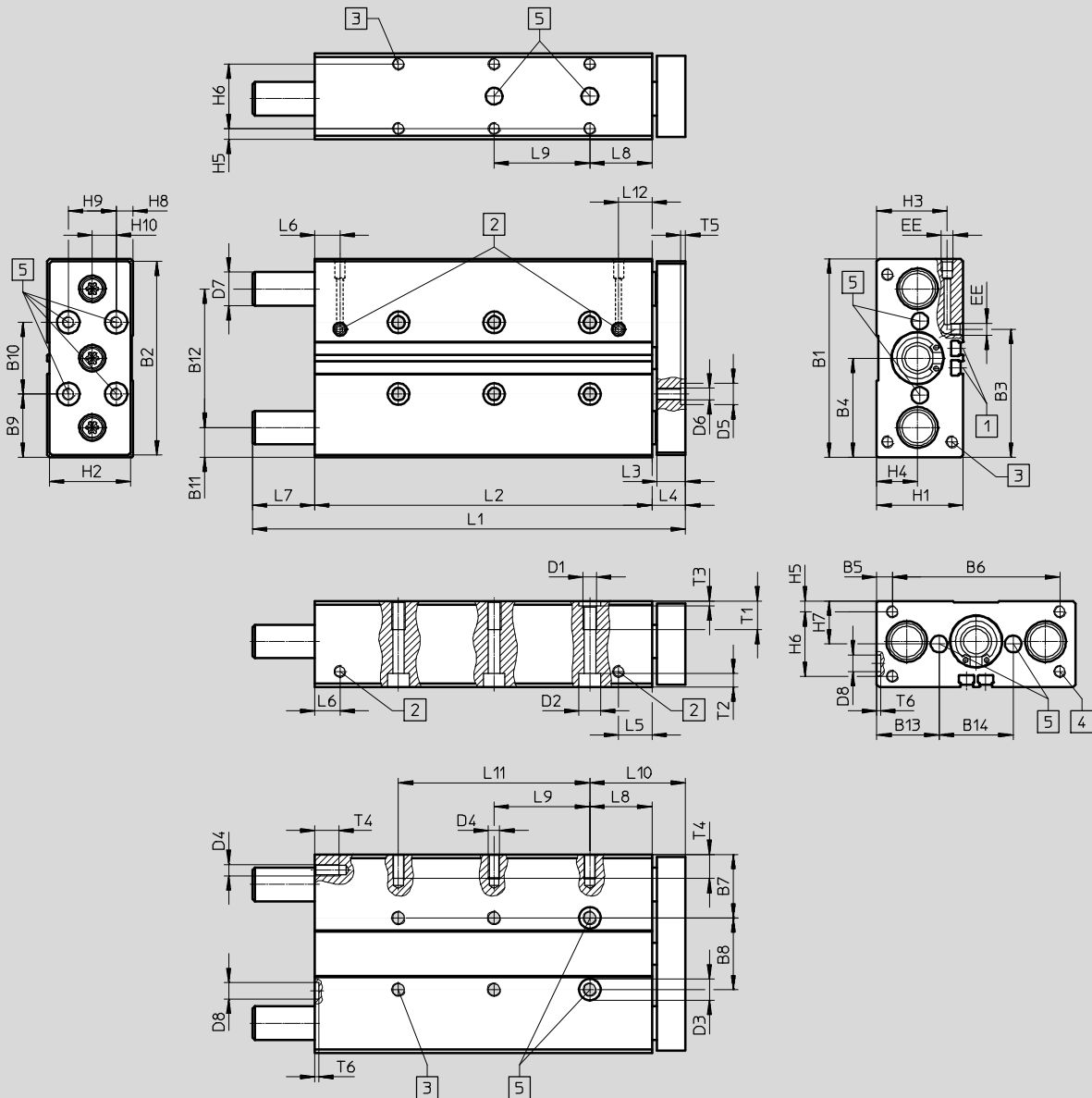

1 Mounting slot for proximity sensor SME-/SMT-8

2 Supply port options on side or top

4 Mounting thread

3 Mounting thread

5 Tolerance between the centring holes ± 0.02 mm

-  Note

Since the guide rods project beyond the contour of the housing in the retracted position (→ dimension L7), when the unit is mounted on its end face an appropriate recess must be provided in the mounting surface so that the guide rods can move freely.

Guided drives DFM

Technical data



∅ [mm]	B1	B2	B3	B4	B5	B6	B7	B8	B9	B10	B11	B12	B13	B14	D1	D2 ∅	D3 ∅ H7
32	110	108	81	55	20	70	33.5	43	35	40	16	78	32.5	45	M8	11	12
40	120	118	94	60	15	90	34.5	51	35	50	16	88	32.5	55	M8	11	12
50	148	146	116.5	74	19	110	42	64	44	60	19	110	40	68	M8	11	12
63	162	160	139	81	9	144	41	80	41	80	18.5	125	39.5	83	M10	15	12

∅ [mm]	D4	D5 ∅ H7	D6	D7 ∅		D8 ∅ H7	EE	H1	H2	H3	H4	H5	H6	H7	H8	H9	H10
				GF	KF												
32	M6	9	M6	20 _{h8}	16 _{h7}	9	G1/8	49	47	38.5	22	6	37	24.5	8.5	30	15
40	M8	9	M6	20 _{h8}	16 _{h7}	9	G1/8	54	52	40.5	24	6	42	27	10	30	15
50	M8	12	M8	25 _{h8}	20 _{h7}	12	G1/4	64	62	50.5	29.5	7	50	32	12	40	20
63	M10	12	M8	25 _{h8}	20 _{h7}	12	G1/4	78	76	55	32	9	60	39	19	40	20

∅ [mm]	Stroke [mm]	L1	L2	L3	L4	L5	L6	L7	L8	L9	L10	L11	L12	T1	T2	T3	T4	T5	T6
32	20	101	68	14	16	17	12	17	29	-	45	-	17	15	6.8	2.6	12	2.1	2.1
	25	106	73					17		20		-							
	30	111	78					17		20		-							
	40	121	88					17		20		-							
	50	131	98					17		40		-							
	80	179	128					35		40		-							
	100	199	148					35		40		80							
	125	244	173					55		40		80							
	160	279	208					55		40		120							
	200	319	248					55		40		160							
40	25	106	76	14	16	17.8	13.1	14	29	20	45	-	17.8	15	6.8	2.6	16	2.1	2.1
	50	131	101					14		40		-							
	80	179	131					32		40		-							
	100	199	151					32		40		80							
	125	244	176					52		40		80							
	160	279	211					52		40		120							
	200	319	251					52		40		160							
50	25	118	77	16	18	17.8	14.2	23	32	20	50	-	17.8	15	6.8	2.6	16	2.6	2.6
	50	143	102					23		40		-							
	80	194	132					44		40		-							
	100	214	152					44		40		80							
	125	259	177					64		40		80							
	160	294	212					64		40		120							
	200	334	252					64		40		160							
63	25	118	83	16	18	18.5	14.8	17	32	20	50	-	18.5	20	9	2.6	20	2.6	2.6
	50	143	108					17		40		-							
	80	194	138					38		40		80							
	100	214	158					38		40		80							
	125	259	183					58		40		120							
	160	294	218					58		40		160							
	200	334	258					58		40		200							

• - Note: This product conforms to ISO 1179-1 and to ISO 228-1

Guided drives DFM

Technical data

FESTO

Dimensions

∅ 80 ... 100 mm

Download CAD data → www.festo.com

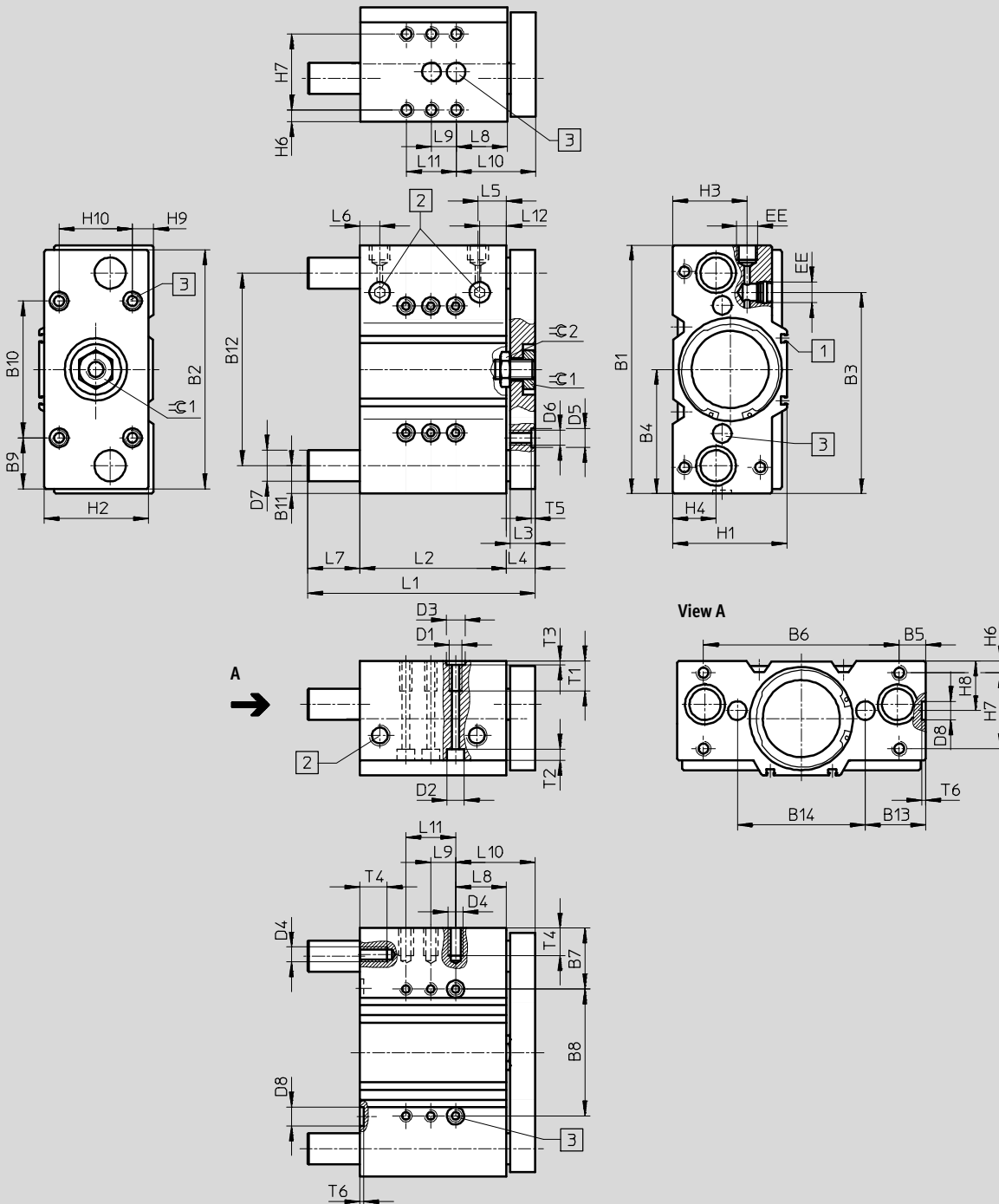

1 Mounting slot for proximity sensor SME-/SMT-8

2 Supply port options on side or top

3 Tolerance between the centring holes ± 0.02 mm

-  - Note

Since the guide rods project beyond the contour of the housing in the retracted position (→ dimension L7), when the unit is mounted on its end face an appropriate recess must be provided in the mounting surface so that the guide rods can move freely.

Guided drives DFM

Technical data



∅ [mm]	B1	B2	B3	B4	B5	B6	B7	B8	B9	B10	B11	B12	B13	B14	D1	D2 ∅	D3 ∅ H7
80	200	192	162.5	100	21.5	157	48.5	103	41	110	22.5	155	48.5	103	M10	15	12
100	240	232	201	120	21	198	54	132	56	120	26	188	57	126	M12	18	15

∅ [mm]	D4	D5 ∅ H7	D6	D7 ∅		D8 ∅ H7	EE	H1	H2	H3	H4	H6	H7	H8	H9	H10
				GF	KF											
80	M10	12	M10	30h8	25h6	12	G3/8	92	84	61	35	9	62	40	16	60
100	M12	15	M12	35h8	30h6	15	G3/8	112	104	66	39.5	10	68	44	16	80

∅ [mm]	Stroke [mm]	L1	L2	L3	L4	L5	L6	L7	L8	L9	L10 ±0.1	L11	L12	T1	T2	T3	T4	T5	T6	≈C1	≈C2
	50	183	118	42	40	-															
	80	243	148	72	40	-															
	100	263	168	72	40	80															
	125	288	193	72	40	80															
	160	323	228	72	40	120															
	200	363	268	72	40	160															
100	25	150	109	20	23	29	20	18	13	40	36	-	29	25	11	3.1	24	3.1	3.1	32	30
	50	197	134					40		40		80									
	80	257	164					70		40		80									
	100	277	184					70		40		120									
	125	302	209					70		40		160									
	160	337	244					70		40		160									
	200	377	284					70		40		200									

• || - Note: This product conforms to ISO 1179-1 and to ISO 228-1

Guided drives DFM

Technical data

FESTO

★ Core product range

Ordering data – Plain-bearing guide GF			
Stroke [mm]	Part No.	Type	
	Ø 12 mm		
10	★ 170824	DFM-12-10-P-A-GF	
20	★ 170825	DFM-12-20-P-A-GF	
25	★ 170826	DFM-12-25-P-A-GF	
30	★ 170827	DFM-12-30-P-A-GF	
40	★ 170828	DFM-12-40-P-A-GF	
50	★ 170829	DFM-12-50-P-A-GF	
80	★ 170830	DFM-12-80-P-A-GF	
100	★ 170831	DFM-12-100-P-A-GF	
	Ø 16 mm		
	★ 170832	DFM-16-10-P-A-GF	
	★ 170833	DFM-16-20-P-A-GF	
	★ 170834	DFM-16-25-P-A-GF	
	★ 170835	DFM-16-30-P-A-GF	
	★ 170836	DFM-16-40-P-A-GF	
	★ 170837	DFM-16-50-P-A-GF	
	★ 170838	DFM-16-80-P-A-GF	
	★ 170839	DFM-16-100-P-A-GF	
	Ø 20 mm		
	–	–	
	★ 170840	DFM-20-20-P-A-GF	
	★ 170841	DFM-20-25-P-A-GF	
	★ 170842	DFM-20-30-P-A-GF	
	★ 170843	DFM-20-40-P-A-GF	
	★ 170844	DFM-20-50-P-A-GF	
	★ 170845	DFM-20-80-P-A-GF	
	★ 170846	DFM-20-100-P-A-GF	
	Ø 25 mm		
20	★ 170847	DFM-25-20-P-A-GF	
25	★ 170848	DFM-25-25-P-A-GF	
30	★ 170849	DFM-25-30-P-A-GF	
40	★ 170850	DFM-25-40-P-A-GF	
50	★ 170851	DFM-25-50-P-A-GF	
80	★ 170852	DFM-25-80-P-A-GF	
100	★ 170853	DFM-25-100-P-A-GF	
125	–	–	
160	–	–	
200	–	–	
	Ø 32 mm		
	★ 170854	DFM-32-20-P-A-GF	
	★ 170855	DFM-32-25-P-A-GF	
	★ 170856	DFM-32-30-P-A-GF	
	★ 170857	DFM-32-40-P-A-GF	
	★ 170858	DFM-32-50-P-A-GF	
	★ 170859	DFM-32-80-P-A-GF	
	★ 170860	DFM-32-100-P-A-GF	
	★ 170861	DFM-32-125-P-A-GF	
	★ 170862	DFM-32-160-P-A-GF	
	★ 170863	DFM-32-200-P-A-GF	
	Ø 40 mm		
	–	–	
	★ 170864	DFM-40-25-P-A-GF	
	–	–	
	–	–	
	★ 170865	DFM-40-50-P-A-GF	
	★ 170866	DFM-40-80-P-A-GF	
	★ 170867	DFM-40-100-P-A-GF	
	★ 170868	DFM-40-125-P-A-GF	
	★ 170869	DFM-40-160-P-A-GF	
	★ 170870	DFM-40-200-P-A-GF	
	Ø 50 mm		
25	★ 170871	DFM-50-25-P-A-GF	
50	★ 170872	DFM-50-50-P-A-GF	
80	★ 170873	DFM-50-80-P-A-GF	
100	★ 170874	DFM-50-100-P-A-GF	
125	★ 170875	DFM-50-125-P-A-GF	
160	★ 170876	DFM-50-160-P-A-GF	
200	★ 170877	DFM-50-200-P-A-GF	
	Ø 63 mm		
	★ 170878	DFM-63-25-P-A-GF	
	★ 170879	DFM-63-50-P-A-GF	
	★ 170880	DFM-63-80-P-A-GF	
	★ 170881	DFM-63-100-P-A-GF	
	★ 170882	DFM-63-125-P-A-GF	
	★ 170883	DFM-63-160-P-A-GF	
	★ 170884	DFM-63-200-P-A-GF	

Ordering data – Plain-bearing guide GF			
Stroke [mm]	Part No.	Type	
	Ø 6 mm		
5	4149944	DFM-6-5-P-A-GF	
10	4149945	DFM-6-10-P-A-GF	
15	4149946	DFM-6-15-P-A-GF	
20	4149947	DFM-6-20-P-A-GF	
	Ø 10 mm		
	4154768	DFM-10-5-P-A-GF	
	4154769	DFM-10-10-P-A-GF	
	4154770	DFM-10-15-P-A-GF	
	4154799	DFM-10-20-P-A-GF	
	Ø 80 mm		
25	170885	DFM-80-25-P-A-GF	
50	170886	DFM-80-50-P-A-GF	
80	170887	DFM-80-80-P-A-GF	
100	170888	DFM-80-100-P-A-GF	
125	170889	DFM-80-125-P-A-GF	
160	170890	DFM-80-160-P-A-GF	
200	170891	DFM-80-200-P-A-GF	
	Ø 100 mm		
	170892	DFM-100-25-P-A-GF	
	170893	DFM-100-50-P-A-GF	
	170894	DFM-100-80-P-A-GF	
	170895	DFM-100-100-P-A-GF	
	170896	DFM-100-125-P-A-GF	
	170897	DFM-100-160-P-A-GF	
	170898	DFM-100-200-P-A-GF	

Festo core product range

- ★ Generally ready for shipping ex works in 24 hours
- ☆ Generally ready for shipping ex works in 5 days

Guided drives DFM

Technical data

FESTO

★ Core product range

Ordering data – Recirculating ball bearing guide KF								
	Part No.	Type	Part No.	Type	Part No.	Type		
Stroke [mm]	∅ 12 mm		∅ 16 mm		∅ 20 mm			
10	★ 170899	DFM-12-10-P-A-KF	★ 170907	DFM-16-10-P-A-KF	–	–		
20	★ 170900	DFM-12-20-P-A-KF	★ 170908	DFM-16-20-P-A-KF	★ 170915	DFM-20-20-P-A-KF		
25	★ 170901	DFM-12-25-P-A-KF	★ 170909	DFM-16-25-P-A-KF	★ 170916	DFM-20-25-P-A-KF		
30	★ 170902	DFM-12-30-P-A-KF	★ 170910	DFM-16-30-P-A-KF	★ 170917	DFM-20-30-P-A-KF		
40	★ 170903	DFM-12-40-P-A-KF	★ 170911	DFM-16-40-P-A-KF	★ 170918	DFM-20-40-P-A-KF		
50	★ 170904	DFM-12-50-P-A-KF	★ 170912	DFM-16-50-P-A-KF	★ 170919	DFM-20-50-P-A-KF		
80	★ 170905	DFM-12-80-P-A-KF	★ 170913	DFM-16-80-P-A-KF	★ 170920	DFM-20-80-P-A-KF		
100	★ 170906	DFM-12-100-P-A-KF	★ 170914	DFM-16-100-P-A-KF	★ 170921	DFM-20-100-P-A-KF		
Stroke [mm]	∅ 25 mm		∅ 32 mm		∅ 40 mm			
20	★ 170922	DFM-25-20-P-A-KF	★ 170929	DFM-32-20-P-A-KF	–	–		
25	★ 170923	DFM-25-25-P-A-KF	★ 170930	DFM-32-25-P-A-KF	★ 170939	DFM-40-25-P-A-KF		
30	★ 170924	DFM-25-30-P-A-KF	★ 170931	DFM-32-30-P-A-KF	–	–		
40	★ 170925	DFM-25-40-P-A-KF	★ 170932	DFM-32-40-P-A-KF	–	–		
50	★ 170926	DFM-25-50-P-A-KF	★ 170933	DFM-32-50-P-A-KF	★ 170940	DFM-40-50-P-A-KF		
80	★ 170927	DFM-25-80-P-A-KF	★ 170934	DFM-32-80-P-A-KF	★ 170941	DFM-40-80-P-A-KF		
100	★ 170928	DFM-25-100-P-A-KF	★ 170935	DFM-32-100-P-A-KF	★ 170942	DFM-40-100-P-A-KF		
125	–	–	★ 170936	DFM-32-125-P-A-KF	★ 170943	DFM-40-125-P-A-KF		
160	–	–	★ 170937	DFM-32-160-P-A-KF	★ 170944	DFM-40-160-P-A-KF		
200	–	–	★ 170938	DFM-32-200-P-A-KF	★ 170945	DFM-40-200-P-A-KF		
Stroke [mm]	∅ 50 mm		∅ 63 mm		–			
25	★ 170946	DFM-50-25-P-A-KF	★ 170953	DFM-63-25-P-A-KF	–	–		
50	★ 170947	DFM-50-50-P-A-KF	★ 170954	DFM-63-50-P-A-KF	–	–		
80	★ 170948	DFM-50-80-P-A-KF	★ 170955	DFM-63-80-P-A-KF	–	–		
100	★ 170949	DFM-50-100-P-A-KF	★ 170956	DFM-63-100-P-A-KF	–	–		
125	★ 170950	DFM-50-125-P-A-KF	★ 170957	DFM-63-125-P-A-KF	–	–		
160	★ 170951	DFM-50-160-P-A-KF	★ 170958	DFM-63-160-P-A-KF	–	–		
200	★ 170952	DFM-50-200-P-A-KF	★ 170959	DFM-63-200-P-A-KF	–	–		

Ordering data – Recirculating ball bearing guide KF					
	Part No.	Type	Part No.	Type	
Stroke [mm]	∅ 80 mm		∅ 100 mm		
25	170960	DFM-80-25-P-A-KF	170967	DFM-100-25-P-A-KF	
50	170961	DFM-80-50-P-A-KF	170968	DFM-100-50-P-A-KF	
80	170962	DFM-80-80-P-A-KF	170969	DFM-100-80-P-A-KF	
100	170963	DFM-80-100-P-A-KF	170970	DFM-100-100-P-A-KF	
125	170964	DFM-80-125-P-A-KF	170971	DFM-100-125-P-A-KF	
160	170965	DFM-80-160-P-A-KF	170972	DFM-100-160-P-A-KF	
200	170966	DFM-80-200-P-A-KF	170973	DFM-100-200-P-A-KF	

Festo core product range

- ★ Generally ready for shipping ex works in 24 hours
- ☆ Generally ready for shipping ex works in 5 days

Guided drives DFM-B

Peripherals overview

FESTO

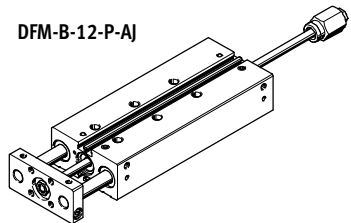
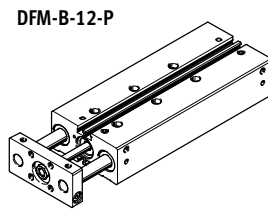
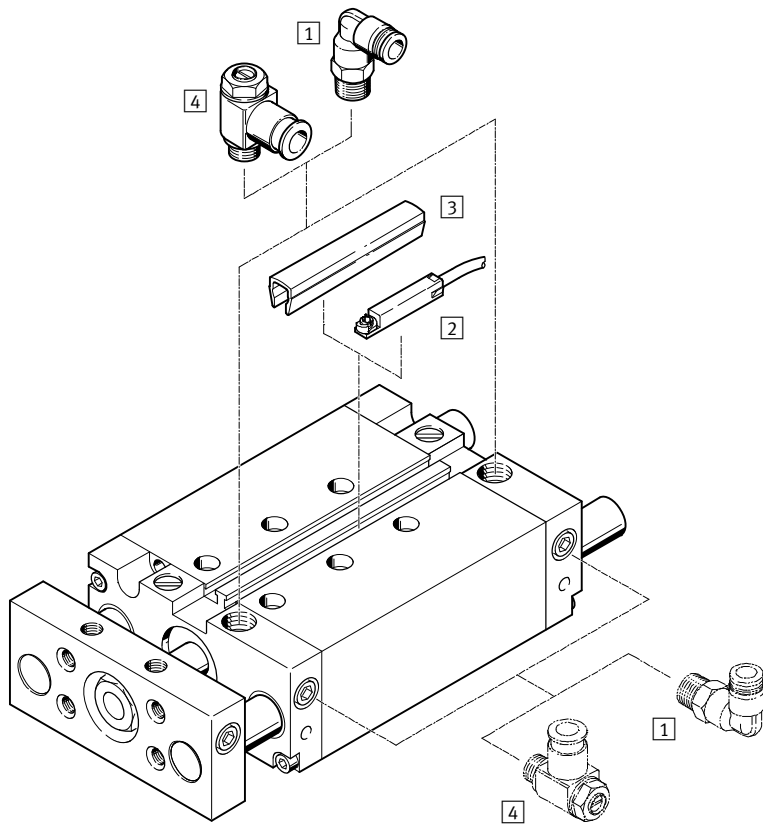

Variants

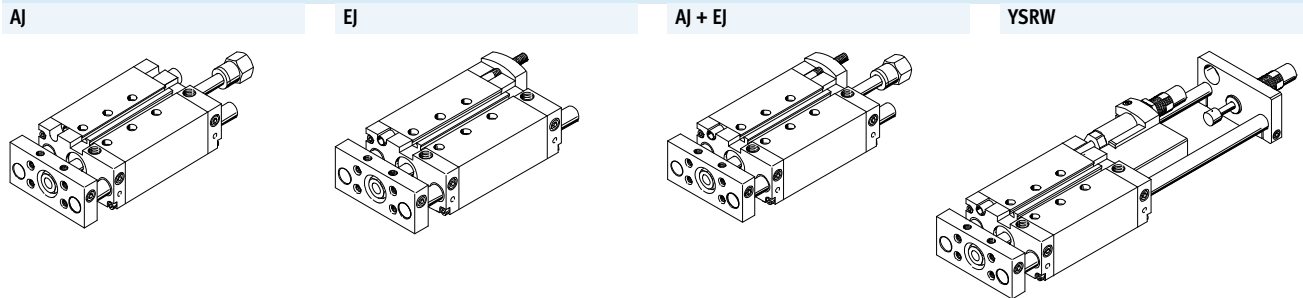

Accessories		Description	→ Page/Internet
1	Push-in fitting QS	For connecting compressed air tubing with standard O.D.	qs
2	Proximity sensor SME-/SMT-8/10	Can be integrated in the profile barrel	69
3	Slot cover ABP-5-S	For protecting the sensor cable and keeping dirt out of the sensor slots	70
4	One-way flow control valve GRLA	For speed regulation	70
-	Centring sleeves ZBH	4 or 6 pieces included in the scope of delivery	68

-  - Note
Proximity sensors SM...0-8E cannot be used with the DFM-B.

Guided drives DFM-B

Type codes

DFM - 50 - 80 - B - P - A - GF - S6 - AJ - ZUB - 10S - G

Type

DFM	Guided drive
-----	--------------

Piston Ø [mm]

Stroke [mm]

Generation

B	Series
---	--------

Cushioning

P	Elastic cushioning rings/plates at both ends
PPV	Pneumatic cushioning, adjustable at both ends
YSRW	Self-adjusting at both ends

Position sensing

A	For proximity sensor
---	----------------------

Guidance

GF	Plain-bearing guide
KF	Recirculating ball bearing guide

Variant

S6	Heat-resistant seals up to max. 120 °C
----	--

Precision adjustment

AJ	Advanced end position
EJ	Retracted end position

Accessories

ZUB	Supplied separately
-----	---------------------

Slot cover

...S	Sensor slot
------	-------------

Proximity sensor

...G	With cable, 2.5 m
...I	Contactless with cable, 2.5 m



Guided drives DFM-B

Technical data

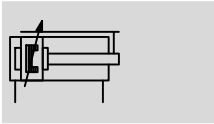
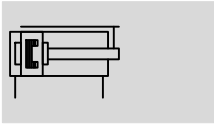
Function



 www.festo.com

-  Diameter
12 ... 63 mm
-  Stroke length
10 ... 400 mm

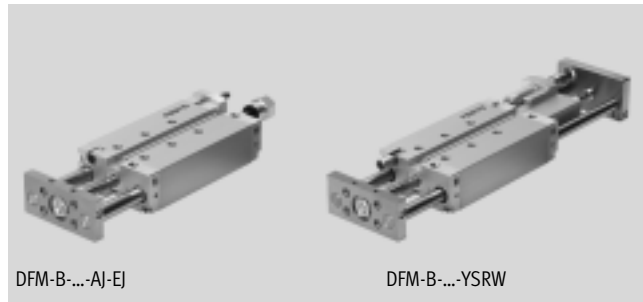
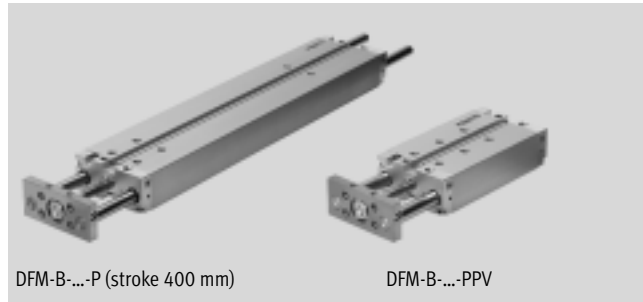

General Technical data									
Piston \varnothing		12	16	20	25	32	40	50	63
Pneumatic connection		M5	M5	M5	G1/8	G1/8	G1/8	G1/4	G1/4
Operating medium		Compressed air to ISO 8573-1:2010 [7:4:4]							
Note on operating/pilot medium		Lubricated operation possible (in which case lubricated operation will always be required)							
Operating pressure [bar]		2 ... 10	2 ... 10	2 ... 10	1.5 ... 10	1.5 ... 10	1.5 ... 10	1 ... 10	1 ... 10
Design		Piston							
		Piston rod							
		Guide rods with yoke							
Cushioning	P	Elastic cushioning rings/plates at both ends							
	PPV	-	Pneumatic cushioning, adjustable at both ends						
	YSRW	-	-	Self-adjusting at both ends					
Cushioning length	PPV [mm]	-	12	15	15	16	17	19	19
Position sensing		For proximity sensor							
Type of mounting		Via through-hole							
		Via female thread							
Mounting position		Any							
Protection against torsion/guide		Guide rod with yoke/plain-bearing or recirculating ball bearing guide							
Variant AJ									
Setting range [mm]		0 ... 10							
Variant EJ and YSRW									
Setting range [mm]		-	-	0 ... 10					
Variant YSRW with shock absorber									
Repetition accuracy [mm]		-	-	Max. 0.05					

- || - Note: This product conforms to ISO 1179-1 and to ISO 228-1

Guided drives DFM-B

Technical data

FESTO

Environmental conditions				
	Plain-bearing guide GF	Recirculating ball bearing guide KF	YSRW with shock absorber	S6
Ambient temperature ¹⁾ [°C]	-20 ... +80	-5 ... +60	0 ... +60	0 ... +120
Corrosion resistance class CRC ²⁾	2	-	-	2
ATEX	Specified types → www.festo.com			

1) Note operating range of proximity sensors

2) Corrosion resistance class CRC 2 to Festo standard FN 940070

Moderate corrosion stress. Indoor applications in which condensation may occur. External visible parts with primarily decorative requirements for the surface and which are in direct contact with the ambient atmosphere typical for industrial applications.

Speed [m/s]								
Piston Ø	12	16	20	25	32	40	50	63
Cushioning P, precision stroke adjustment AJ and EJ								
Maximum speed advancing, retracting	0.8	0.8	0.8	0.8	0.8	0.8	0.6	0.6
Cushioning P, plain-bearing guide GF in combination with S6								
Maximum speed advancing, retracting	0.5	0.5	0.5	0.5	0.5	0.5	0.4	0.4
Cushioning PPV, YSRW, PPV S6								
Maximum speed advancing, retracting	-	1.5	1.5	1.5	1.5	1.5	1	1

Forces [N]								
Piston Ø	12	16	20	25	32	40	50	63
Cushioning P, PPV, YSRW, precision stroke adjustment EJ								
Theoretical force at 6 bar, advancing	68	121	188	295	482	754	1178	1870
Theoretical force at 6 bar, retracting	51	90	141	247	415	686	1057	1750
Precision stroke adjustment AJ and AJ+EJ								
Theoretical force at 6 bar, advancing	51	90	141	247	415	686	1057	1750
Theoretical force at 6 bar, retracting	51	90	141	247	415	686	1057	1750

Guided drives DFM-B

Technical data



Impact energy [J]								
Piston Ø	12	16	20	25	32	40	50	63
Cushioning P								
Max. impact energy in the end positions	0.09	0.15	0.2	0.35	0.40	0.7	1.0	1.3
Max. impact energy in the end positions S6	0.035	0.075	0.1	0.15	0.2	0.35	0.5	0.65
Cushioning YSRW								
Max. energy consumption per stroke	-	-	4	8	12	35	35	70
Max. energy consumption per hour	-	-	21000	30000	41000	68000	68000	100000

Permissible impact velocity

$$v_{perm.} = \sqrt{\frac{2 \times E_{perm.}}{m_{intrinsic} + m_{Load}}}$$

$v_{perm.}$ Permissible impact velocity
 $E_{perm.}$ Maximum impact energy
 $m_{intrinsic}$ Moving mass (drive)
 m_{Load} Moving payload

 Note
 These specifications represent the maximum values that can be achieved. Note the maximum permissible impact energy.

Maximum permissible load:

$$m_{Load} = \frac{2 \times E_{perm.}}{v^2} - m_{intrinsic}$$

DFM-B with plain-bearing guide GF, cushioning P, PPV								
Stroke [mm]	Piston Ø [mm]							
	12	16	20	25	32	40	50	63
Product weight [g]								
10	385	621	-	-	-	-	-	-
20	432	680	1026	1474	2163	-	-	-
25	452	706	1068	1530	2238	2606	4290	5568
30	476	736	1109	1586	2337	-	-	-
40	523	795	1215	1726	2489	-	-	-
50	570	854	1298	1838	2640	3047	5019	6457
80	712	1033	1572	2218	3210	3663	5909	7503
100	803	1148	1733	2435	3502	3981	6376	8116
125	962	1352	2000	2800	4018	4534	7151	9050
160	1128	1560	2293	3193	4549	5118	8017	10137
200	1318	1797	2628	3642	5158	5786	9007	11379
250	-	-	3237	4430	6259	6962	10813	13509
320	-	-	3823	5215	7322	8129	12545	15682
400	-	-	4493	6113	8537	9462	14525	18165
Moving mass [g]								
10	201	283	-	-	-	-	-	-
20	216	302	506	715	1147	-	-	-
25	223	312	520	734	1176	1305	2217	2640
30	230	322	534	753	1230	-	-	-
40	245	342	586	823	1289	-	-	-
50	260	362	615	861	1347	1476	2567	2990
80	304	423	724	1022	1644	1776	3002	3426
100	333	463	781	1098	1764	1893	3189	3613
125	420	579	917	1289	2059	2188	3586	4009
160	472	649	1016	1422	2264	2393	3913	4336
200	530	730	1129	1573	2499	2627	4286	4710
250	-	-	1489	2017	3164	3293	5351	5774
320	-	-	1688	2283	3574	3703	6005	6428
400	-	-	1914	2587	4042	4171	6752	7176

Guided drives DFM-B

Technical data

FESTO

DFM-B with plain-bearing guide GF, cushioning P, PPV, variant S6								
Stroke [mm]	Piston Ø [mm]							
	12	16	20	25	32	40	50	63
Product weight [g]								
0	283	488	745	1080	1594	1847	3124	3992
10	328	548	–	–	–	–	–	–
20	376	607	907	1298	1889	–	–	–
25	395	633	949	1354	1964	2257	3735	4762
30	419	663	990	1410	2063	–	–	–
40	466	722	1096	1550	2215	–	–	–
50	514	781	1179	1662	2366	2698	4464	5651
80	656	959	1452	2042	2936	3314	5354	6696
100	747	1074	1614	2259	3228	3632	5821	7310
125	905	1279	1880	2624	3745	4186	6596	8244
160	1072	1486	2173	3017	4276	4770	7462	9331
200	1261	1724	2508	3466	4884	5437	8452	10573
250	–	–	3118	4254	5985	6613	10258	12703
320	–	–	3704	5039	7048	7780	11990	14876
400	–	–	4374	5937	8264	9114	19970	17359
Moving mass [g]								
0	130	188	329	463	755	810	1428	1601
10	145	208	–	–	–	–	–	–
20	159	229	386	539	873	–	–	–
25	167	239	400	558	902	956	1662	1834
30	174	249	414	577	956	–	–	–
40	188	269	467	647	1015	–	–	–
50	203	289	495	685	1073	1127	2012	2184
80	247	349	604	847	1373	1427	2447	2620
100	276	389	661	922	1490	1544	2634	2806
125	364	506	797	1113	1785	1840	3031	3203
160	415	576	896	1246	1990	2045	3358	3530
200	474	657	1010	1397	2225	2279	3731	3904
250	–	–	1370	1842	2890	2944	4796	4968
320	–	–	1568	2107	3300	3354	5450	5622
400	–	–	1794	2411	3768	3823	6197	6370

Guided drives DFM-B

Technical data



DFM-B with recirculating ball bearing guide KF, cushioning P, PPV								
Stroke [mm]	Piston Ø [mm]							
	12	16	20	25	32	40	50	63
Product weight [g]								
10	345	543	–	–	–	–	–	–
20	388	596	935	1395	1932	–	–	–
25	405	619	974	1447	1998	2366	3907	5185
30	427	647	1012	1499	2079	–	–	–
40	470	700	1105	1624	2213	–	–	–
50	513	754	1181	1729	2346	2753	4523	5961
80	641	916	1428	2074	2817	3270	5272	6865
100	723	1020	1577	2276	3073	3552	5682	7423
125	852	1190	1809	2599	3490	4006	6327	8226
160	1002	1378	2079	2966	3958	4526	7094	9214
200	1174	1593	2388	3384	4494	5121	7971	10343
250	–	–	2905	4073	5369	6072	9419	12115
320	–	–	3445	4805	6305	7112	10953	14091
400	–	–	4063	5642	7376	8301	12707	16347
Moving mass [g]								
10	168	239	–	–	–	–	–	–
20	178	254	437	631	933	–	–	–
25	183	261	447	646	954	1082	1830	2254
30	188	268	458	661	990	–	–	–
40	198	283	498	716	1030	–	–	–
50	208	297	520	746	1071	1199	2067	2491
80	238	341	602	873	1271	1400	2361	2785
100	259	370	646	934	1352	1481	2492	2915
125	316	452	748	1083	1548	1677	2758	3182
160	352	503	824	1189	1690	1819	2986	3410
200	392	561	911	1310	1852	1981	3247	3671
250	–	–	1180	1656	2291	2420	3953	4377
320	–	–	1332	1868	2575	2703	4410	4833
400	–	–	1505	2111	2899	3027	4931	5355

Guided drives DFM-B

Technical data

FESTO

Additional weights with precision stroke adjustment AJ – GF, KF

When using the precision stroke adjustment AJ, the following weight must be taken into account in addition to the load specified from page 40.

Product weight [g] – Precision stroke adjustment AJ (piston rod + stop)								
Stroke [mm]	Piston Ø [mm]							
	12	16	20	25	32	40	50	63
10	55.4	58.8	–	–	–	–	–	–
20	57.6	61	75.6	115.4	185.7	–	–	–
25	58.7	62.1	77.6	118.5	190.2	188.7	350.7	350.5
30	59.9	63.3	79.6	121.6	194.7	–	–	–
40	62.1	65.5	83.6	127.8	203.6	–	–	–
50	64.3	67.7	87.5	134	212.5	211	390.4	390.2
80	71	74.4	99.5	152.6	239.3	237.8	438	437.8
100	75.5	78.9	107.5	165	257.2	255.7	469.8	469.6
125	81.1	84.5	117.3	180.5	279.5	278	509.5	509.3
160	88.9	92.3	131.2	202.5	310.8	309.3	565.1	564.9
200	97.8	101.2	147.1	227	346.5	345	628.6	628.4
250	–	–	167	258.1	391.2	389.7	708.1	707.9
320	–	–	194.8	301.5	453.8	452.3	819.2	819
400	–	–	226.5	351.1	525.2	523.7	946.3	946.1

Moving mass [g] – Precision stroke adjustment AJ (piston rod + stop)								
Stroke [mm]	Piston Ø [mm]							
	12	16	20	25	32	40	50	63
10	51.5	52.3	–	–	–	–	–	–
20	53.7	54.5	76	116.6	185.9	–	–	–
25	54.8	55.6	78	119.7	190.4	190	351.7	351.7
30	56	56.8	80	122.8	194.9	–	–	–
40	58.2	59	84	129	203.8	–	–	–
50	60.4	61.2	87.9	135.2	212.7	212.7	391.4	391.4
80	67.1	67.9	99.9	153.8	239.5	239.5	439	439
100	71.6	72.4	107.8	166.2	257.4	257.4	470.8	470.8
125	77.2	78	117.7	181.7	279.7	279.7	510.5	510.5
160	85	85.8	131.6	203.4	311	311	566.1	566.1
200	93.9	94.7	147.5	228.2	346.7	346.7	629.6	629.6
250	–	–	167.4	259.3	391.4	391.4	709.1	709.1
320	–	–	195.2	302.7	454	454	820.2	820.2
400	–	–	226.9	352.3	525.4	525.4	947.3	947.3

Guided drives DFM-B

Technical data



Additional weights with precision stroke adjustment E] – GF, KF

When using the precision stroke adjustment E], the following weight must be taken into account in addition to the load specified from page 40.

Product weight [g] – Precision stroke adjustment E] (piston rod + stop)						
Stroke [mm]	Piston Ø [mm]					
	20	25	32	40	50	63
20	55.7	117.1	134.1	–	–	–
25	56.4	119.1	136.1	153.9	302.8	354
30	57.2	121	138	–	–	–
40	58.8	125	142	–	–	–
50	60.3	129	146	163.8	318.3	369.5
80	65	140.9	157.9	175.7	336.9	388.1
100	68.1	148.8	165.8	183.6	349.4	400.6
125	71.9	158.8	175.8	193.6	364.9	416.1
160	77.4	172.7	189.7	207.5	386.6	437.8
200	83.6	188.5	205.5	223.3	411.4	462.6
250	91.3	208.4	225.4	243.2	442.4	493.6
320	102.2	236.2	253.2	271	485.9	537.1
400	114.6	268	285	302.8	535.5	586.7

DFM-B with recirculating ball bearing guide KF, cushioning YSRW						
Stroke [mm]	Piston Ø [mm]					
	20	25	32	40	50	63
Product weight [g]						
20	1684	2641	3717	–	–	–
25	1733	2707	3801	4995	7594	10816
30	1780	2773	3884	–	–	–
40	1874	2903	4053	–	–	–
50	1970	3035	4222	5455	8275	11657
80	2257	3429	4720	5999	9092	12629
100	2444	3687	5047	6352	9614	13298
125	2677	4008	5458	6801	10294	14137
160	3015	4473	6050	7446	11255	15319
200	3401	5004	6728	8183	12354	16670
250	3855	5641	7545	9074	13700	18340
320	4530	6569	8730	10363	15623	20704
400	5302	7631	10085	11837	17821	23405
Moving mass [g]						
20	874	1323	1933	–	–	–
25	894	1350	1969	2386	3735	4996
30	914	1378	2005	–	–	–
40	953	1432	2077	–	–	–
50	993	1487	2149	2566	4021	5282
80	1111	1650	2365	2782	4365	5625
100	1190	1759	2509	2926	4594	5855
125	1289	1896	2690	3106	4880	6141
160	1427	2087	2942	3359	5281	6542
200	1585	2305	3230	3647	5739	7000
250	1782	2578	3590	4007	6312	7572
320	2059	2959	4095	4512	7114	8374
400	2375	3396	4671	5088	8030	9290

Guided drives DFM-B

Technical data

Materials

Sectional view

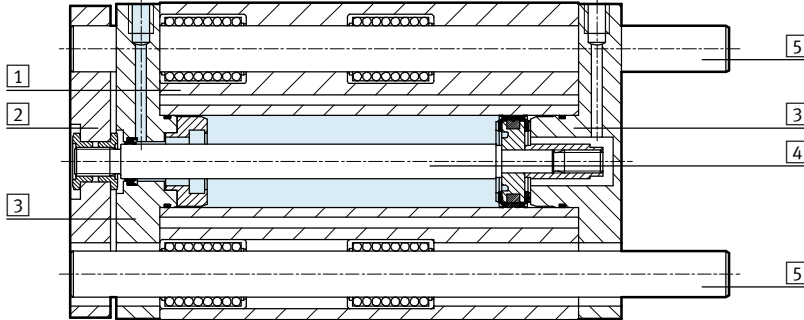

Guided drives	Plain-bearing guide GF	Recirculating ball bearing guide KF	S6
1 Housing	Anodised wrought aluminium alloy	Anodised wrought aluminium alloy	Anodised wrought aluminium alloy
2 Yoke plate	Tempered steel	Tempered steel	Wrought aluminium alloy
3 Bearing and end caps	Anodised wrought aluminium alloy	Anodised wrought aluminium alloy	Anodised wrought aluminium alloy
4 Piston rod	High-alloy stainless steel	High-alloy stainless steel	High-alloy stainless steel
5 Guide rods	High-alloy steel	Hard-chromium plated tempered steel	High-alloy steel
- Static seals	Nitrile rubber	Nitrile rubber	Fluoro elastomer
- Dynamic seals	Polyurethane	Polyurethane	Fluoro elastomer
Note on materials	RoHS compliant		

Maximum payload F [N]

Plain-bearing guide GF and recirculating ball bearing guide KF

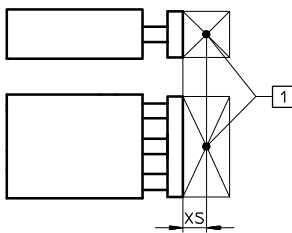

1 Centre of gravity of payload

Piston Ø [mm]	XS [mm]	Stroke [mm]	Stroke [mm]													
			10	20	25	30	40	50	80	100	125	160	200	250	320	400
12	GF	25	53	47	45	43	39	36	28	25	23	20	15	-	-	-
	KF		47	42	40	38	35	32	26	23	20	16	13	-	-	-
16	GF	50	95	86	83	79	73	67	55	49	37	30	25	-	-	-
	KF		75	69	66	64	58	56	51	48	30	21	17	-	-	-
20	GF	50	-	99	96	92	110	103	86	77	71	63	55	47	41	35
	KF		-	80	77	75	91	88	80	75	65	56	47	40	34	29
25	GF	50	-	121	116	112	123	115	96	86	86	76	67	53	45	39
	KF		-	88	86	84	100	97	89	85	80	66	56	46	38	32
32	GF	50	-	188	180	173	161	150	166	150	168	146	127	106	91	78
	KF		-	120	118	116	112	109	134	128	144	135	126	135	125	100
40	GF	50	-	-	180	-	-	150	166	150	168	146	127	106	91	78
	KF		-	-	118	-	-	109	134	128	144	135	126	135	125	100
50	GF	50	-	-	257	-	-	216	234	212	229	200	174	145	124	105
	KF		-	-	182	-	-	168	201	193	211	199	188	179	158	130
63	GF	50	-	-	257	-	-	216	234	212	229	200	174	145	124	105
	KF		-	-	182	-	-	168	201	193	211	199	188	179	158	130

- Note

Engineering software GSED

→ www.festo.com

Guided drives DFM-B

Technical data

Permitted torque loading M [Nm]

Plain-bearing guide GF and recirculating ball bearing guide KF

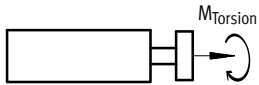

Piston Ø [mm]		Stroke [mm]													
		10	20	25	30	40	50	80	100	125	160	200	250	320	400
12	GF	1.10	0.95	0.90	0.85	0.80	0.75	0.60	0.50	0.45	0.40	0.30	-	-	-
	KF	0.95	0.85	0.80	0.75	0.70	0.65	0.50	0.45	0.40	0.30	0.25	-	-	-
16	GF	2.20	2.00	1.90	1.80	1.70	1.50	1.30	1.10	0.85	0.70	0.60	-	-	-
	KF	1.70	1.60	1.50	1.45	1.35	1.30	1.20	1.10	0.70	0.50	0.40	-	-	-
20	GF	-	2.90	2.80	2.70	3.20	3.00	2.50	2.20	2.10	1.80	1.60	1.40	1.20	1.00
	KF	-	2.30	2.20	2.15	2.60	2.55	2.30	2.20	1.90	1.60	1.40	1.20	1.00	0.85
25	GF	-	4.15	3.95	3.80	4.20	3.90	3.25	2.90	2.90	2.60	2.30	1.80	1.50	1.30
	KF	-	3.00	2.92	2.85	3.40	3.30	3.02	2.89	2.70	2.20	1.90	1.50	1.30	1.10
32	GF	-	7.30	7.00	6.70	6.20	5.80	6.40	5.80	6.50	5.70	5.00	4.10	3.50	3.00
	KF	-	4.70	4.60	4.55	4.40	4.25	5.25	5.00	5.60	5.25	4.90	5.20	4.80	3.90
40	GF	-	-	7.90	-	-	6.55	7.25	6.55	7.35	6.40	5.55	4.60	4.0	3.40
	KF	-	-	5.20	-	-	4.80	5.90	5.65	6.35	5.95	5.55	5.95	5.50	4.40
50	GF	-	-	14.15	-	-	11.85	12.85	11.65	12.55	11.00	9.60	7.98	6.82	5.78
	KF	-	-	10.00	-	-	9.30	11.00	10.6	11.60	11.00	10.30	9.82	8.67	7.17
63	GF	-	-	15.90	-	-	13.30	14.45	13.10	14.10	12.30	10.70	9.06	7.75	6.56
	KF	-	-	11.30	-	-	10.50	12.50	12.00	13.20	12.40	11.70	11.16	9.85	8.15

Torsional backlash P

Plain-bearing guide GF and recirculating ball bearing guide KF in retracted state, without load

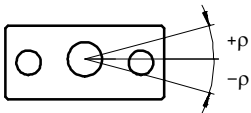

Piston Ø		12	16	20	25	32	40	50	63
Average torsional backlash [°]	GF	±0.03	±0.04	±0.03	±0.02	±0.03	±0.02	±0.02	±0.02
Torsional backlash [°]	KF	±0.03	±0.02	±0.02	±0.02	±0.01	±0.01	±0.02	±0.02

Guided drives DFM-B

Technical data

Deflection of end plate

Mean deflection f_1 due to bearing backlash as a function of stroke l (with no load)

DFM-GF with 2 bearings per guide rod

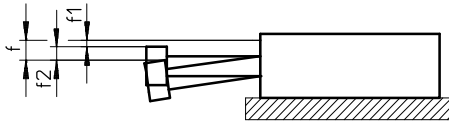

$f = f_1 + f_2$

f = Total deflection of end plate

f_1 = Deflection due to average bearing clearance
(with production tolerance ± 0.01 mm)

f_2 = Deflection due to lateral force

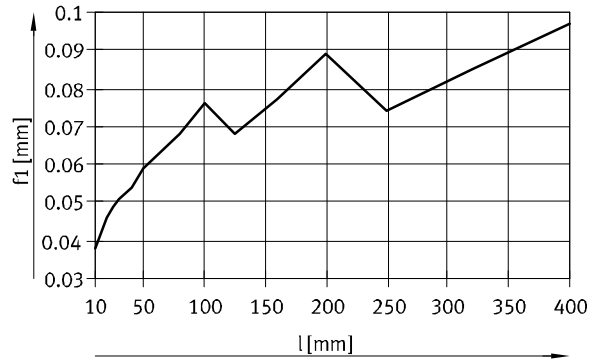

Deflection f_2 due to lateral force F as a function of stroke with plain-bearing guide GF

50 mm stroke

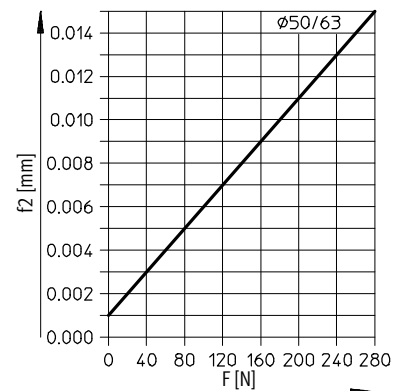
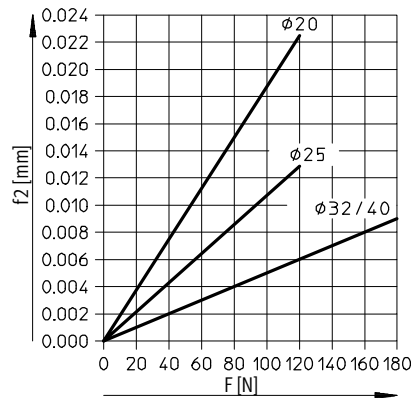
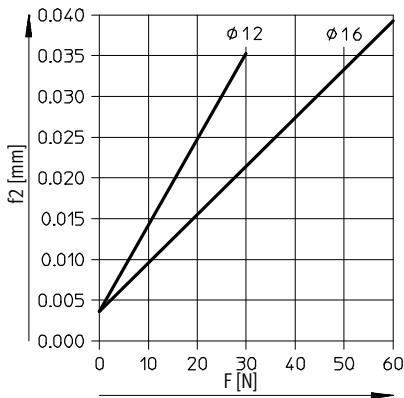

100 mm stroke

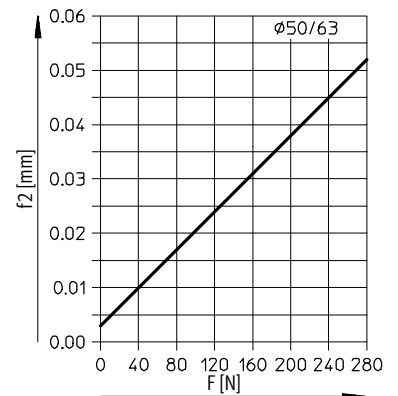
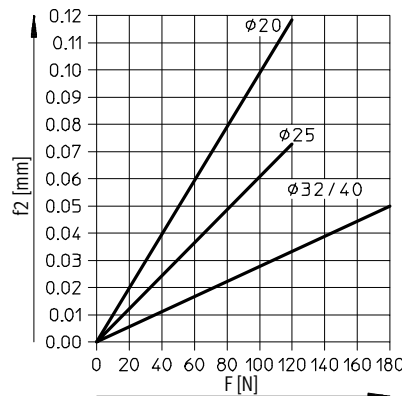
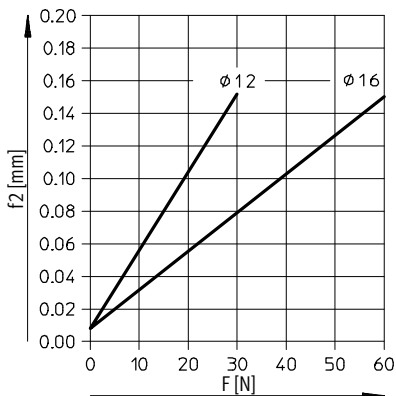

Guided drives DFM-B

Technical data



Deflection of end plate

Mean deflection f_1 due to bearing backlash as a function of stroke l (with no load)

DFM-GF with 2 bearings per guide rod

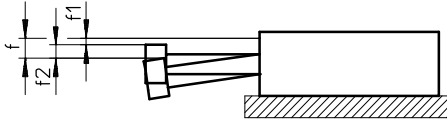

$$f = f_1 + f_2$$

f = Total deflection of end plate

f_1 = Deflection due to average bearing clearance
(with production tolerance ± 0.01 mm)

f_2 = Deflection due to lateral force

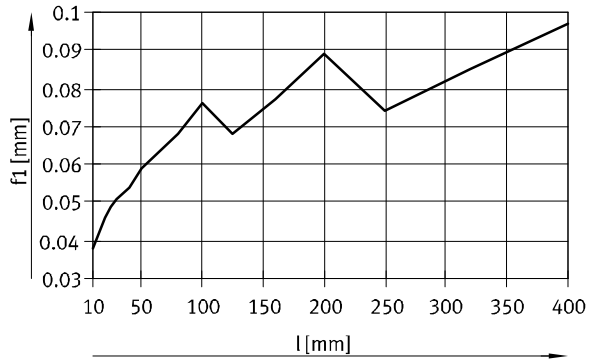

Deflection f_2 due to lateral force F as a function of stroke with plain-bearing guide GF

200 mm stroke

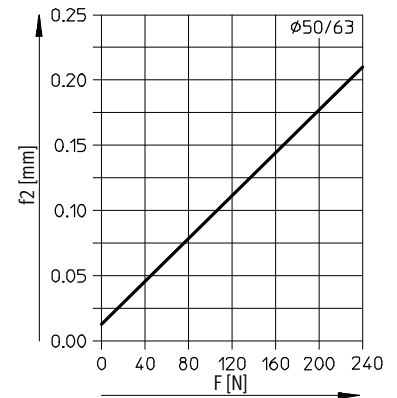
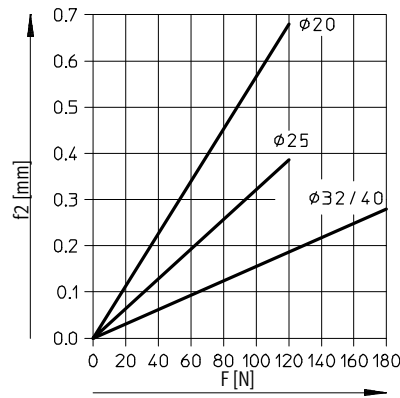
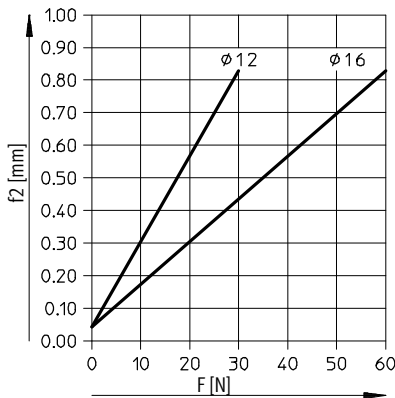

400 mm stroke

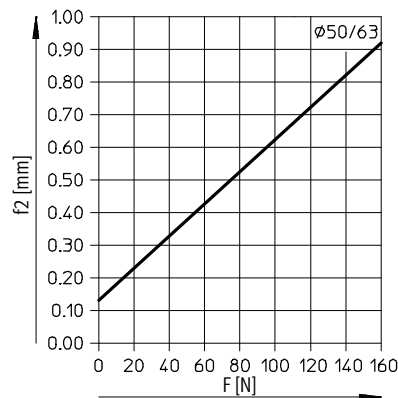
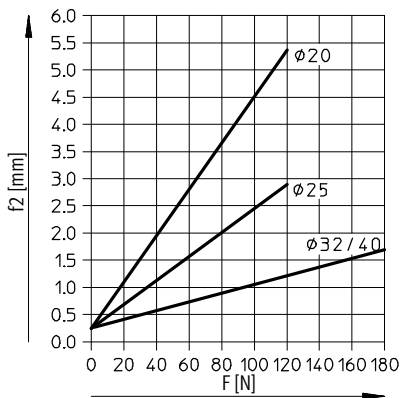

Guided drives DFM-B

Technical data

Deflection of end plate

Deflection f_1 due to bearing clearance as a function of stroke l (with no load)

DFM-KF with 2 bearings per guide rod

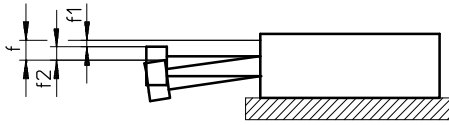

$f = f_1 + f_2$

f = Total deflection of end plate

f_1 = Deflection due to average bearing clearance (determined through series of tests)

f_2 = Deflection due to lateral force

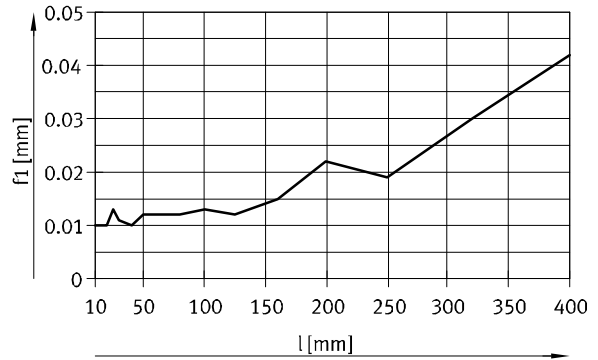

Deflection f_2 due to lateral force F as a function of stroke with recirculating ball bearing guide KF

50 mm stroke

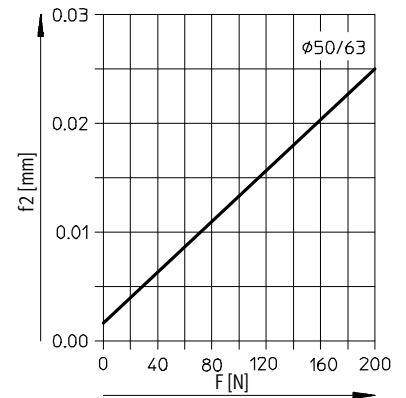
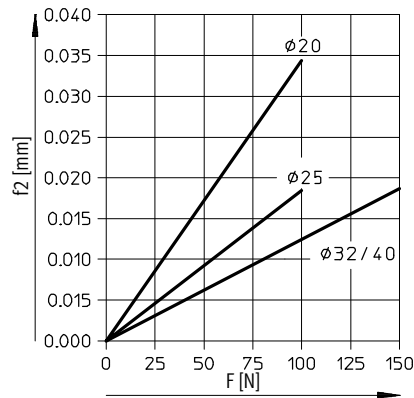
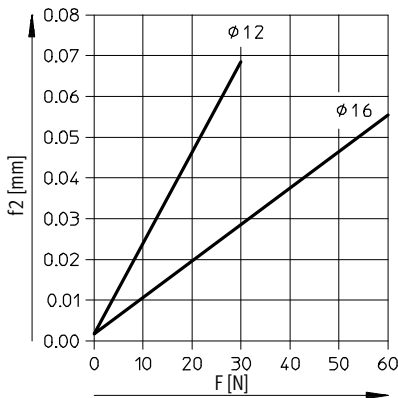

100 mm stroke

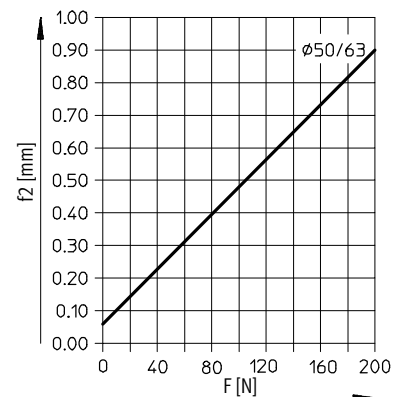
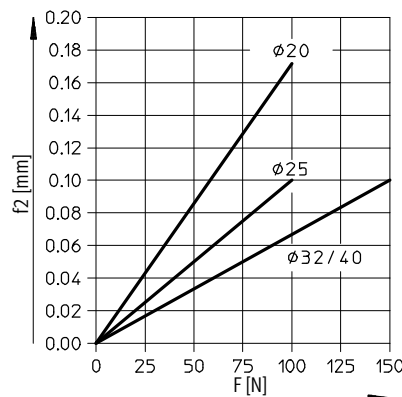
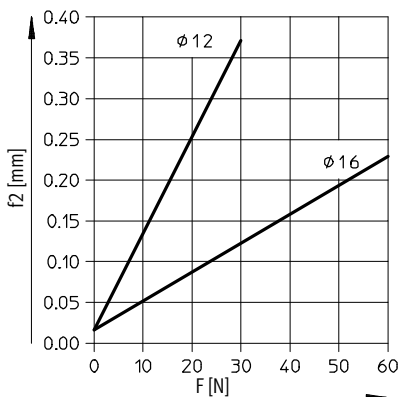

Guided drives DFM-B

Technical data



Deflection of end plate

Deflection f_1 due to bearing clearance as a function of stroke l (with no load)

DFM-KF with 2 bearings per guide rod

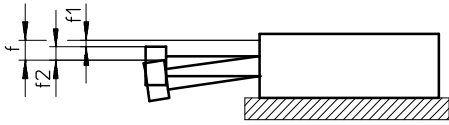

$$f = f_1 + f_2$$

f = Total deflection of end plate

f_1 = Deflection due to average bearing clearance
(determined through series of tests)

f_2 = Deflection due to lateral force

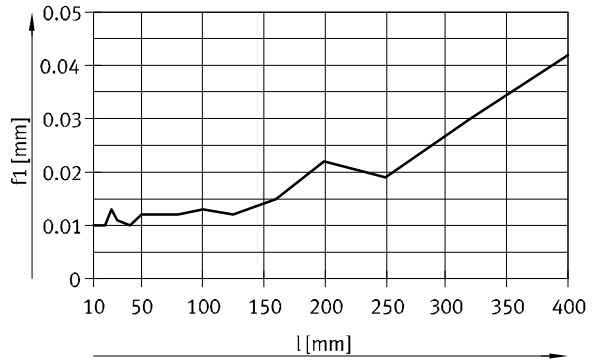

Deflection f_2 due to lateral force F as a function of stroke with recirculating ball bearing guide KF

200 mm stroke

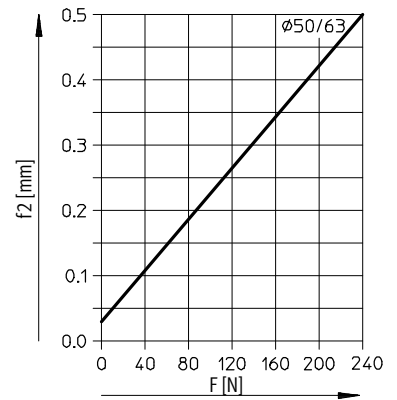
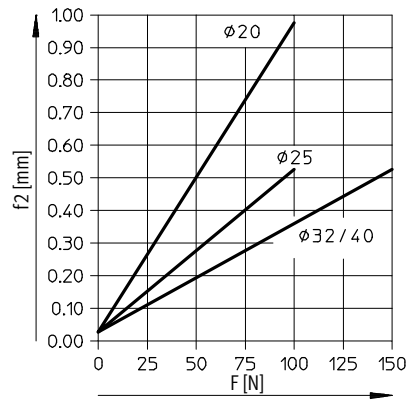
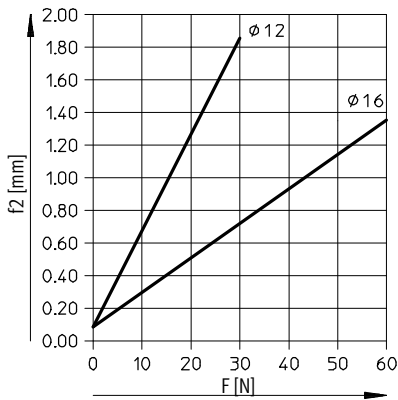

400 mm stroke

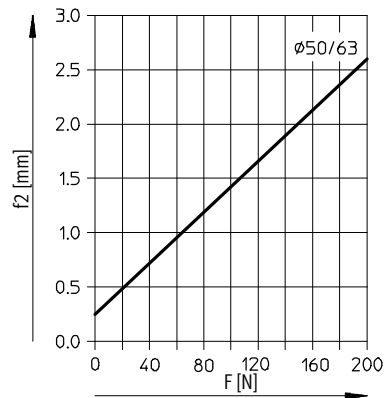
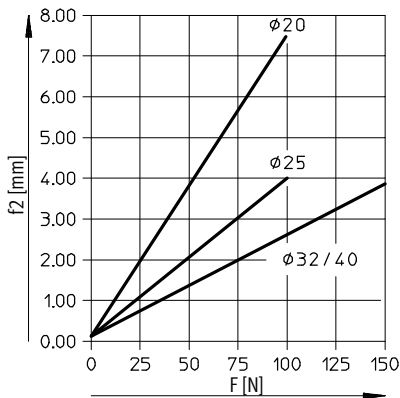

Guided drives DFM-B

Technical data

Used as a lifting cylinder

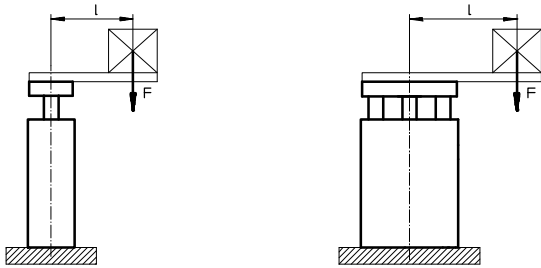

- Note

Additional graphs
→ starting on page 16.

F = Lateral force [N]
l = Lever arm [mm]

Permissible load with plain-bearing guide GF

Stroke 40 ... 400 mm

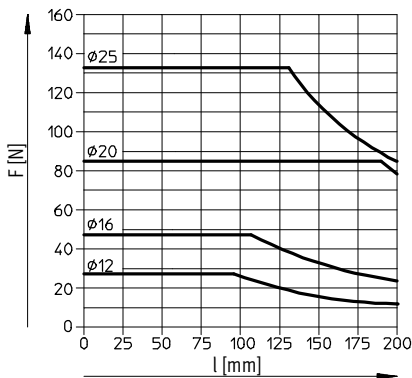

Stroke 250 ... 400 mm

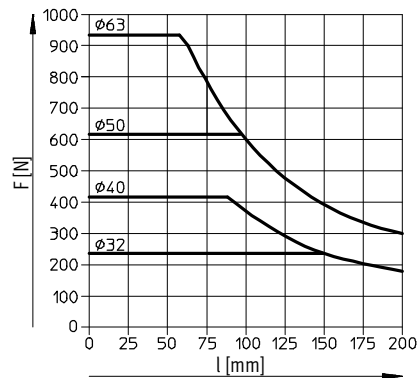

Permissible load with recirculating ball bearing guide KF

Stroke 40 ... 100 mm

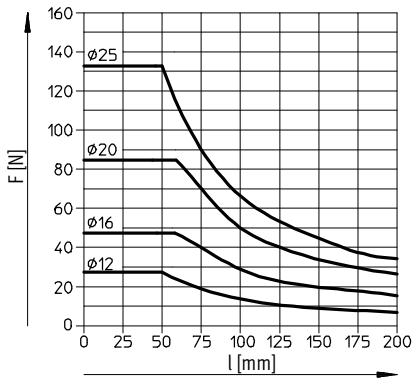

Stroke 125 ... 200 mm

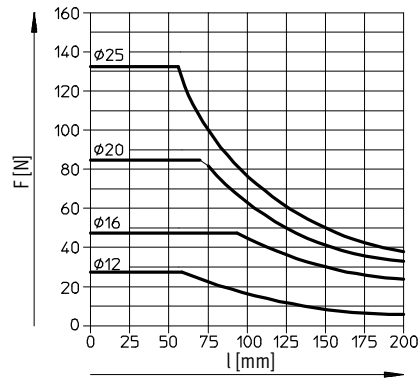

Stroke 250 ... 400 mm

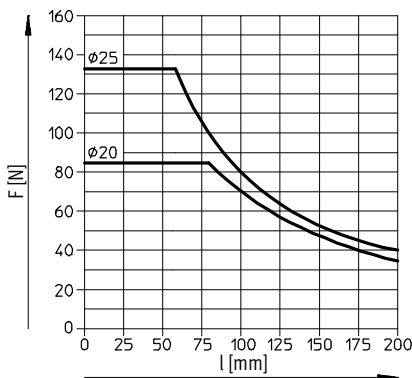

Stroke 200 ... 400 mm

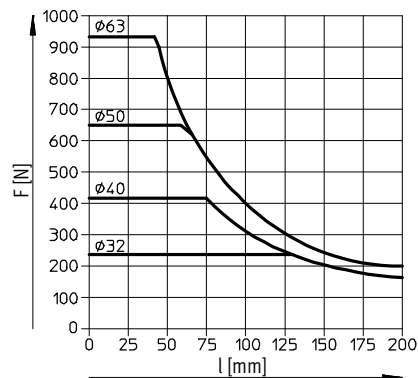

Guided drives DFM-B

Technical data



Permissible load m as a function of permissible speed v
Horizontal operation, cushioning YSRW

DFM-20...-B-YSRW

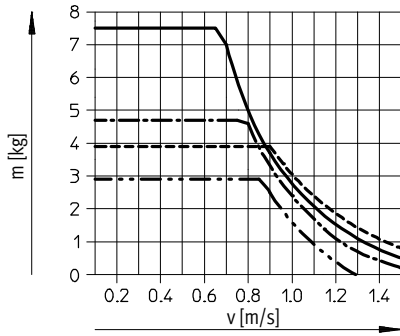

DFM-25...-B-YSRW

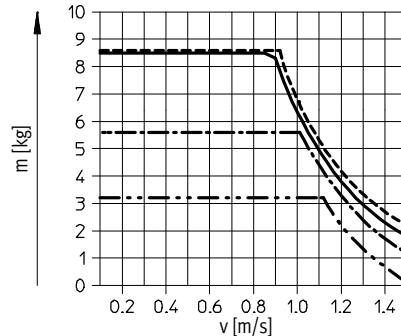

DFM-32...-B-YSRW

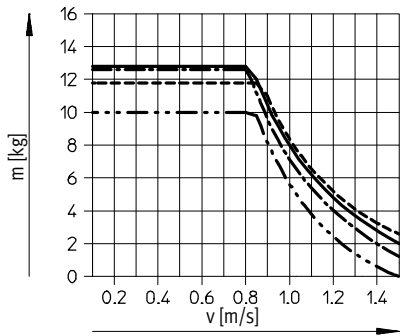

DFM-40...-B-YSRW

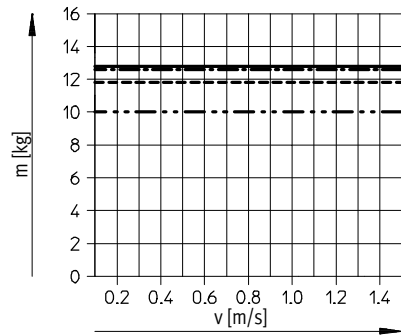

DFM-50...-B-YSRW

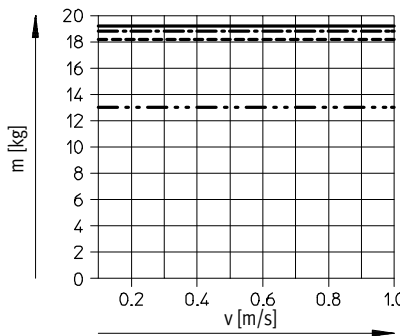

DFM-63...-B-YSRW

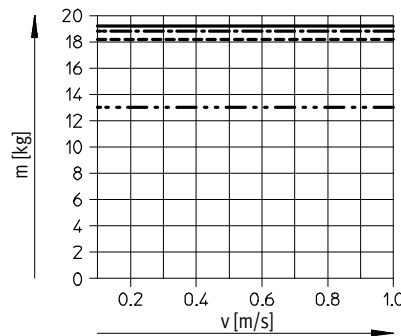

- 25 mm stroke
- 100 mm stroke
- · - · - 200 mm stroke
- · · · · 400 mm stroke

Guided drives DFM-B

Technical data

Permissible load m as a function of permissible speed v

Vertical operation, cushioning YSRW

DFM-20...-B-YSRW

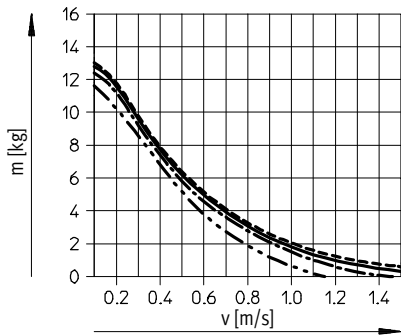

DFM-25...-B-YSRW

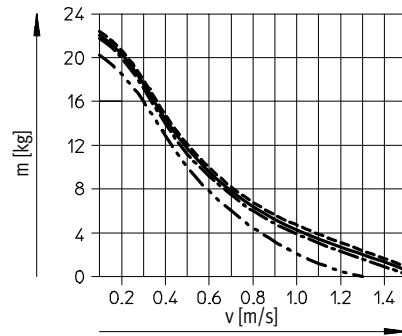

DFM-32...-B-YSRW

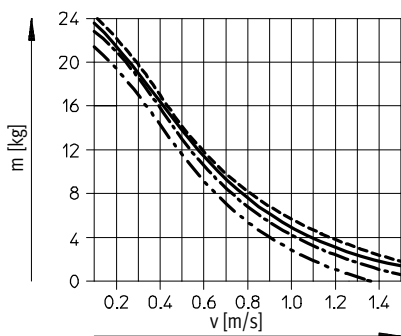

DFM-40...-B-YSRW

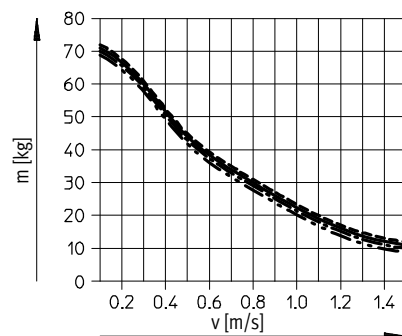

DFM-50...-B-YSRW

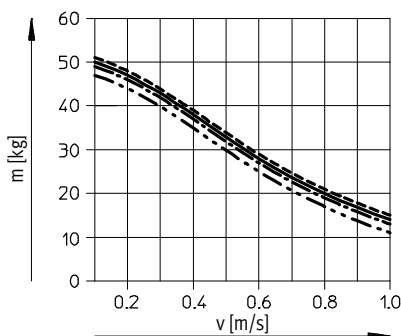

DFM-63...-B-YSRW

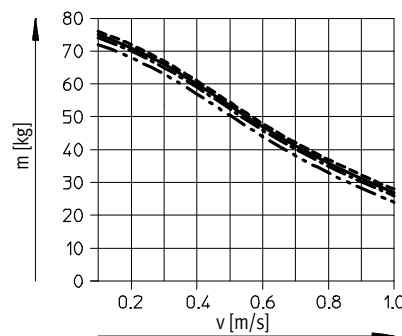

- 25 mm stroke
- 100 mm stroke
- · - · - 200 mm stroke
- · · · · 400 mm stroke

Guided drives DFM-B

Technical data



Dimensions

Ø 12, 16 mm

Download CAD data → www.festo.com

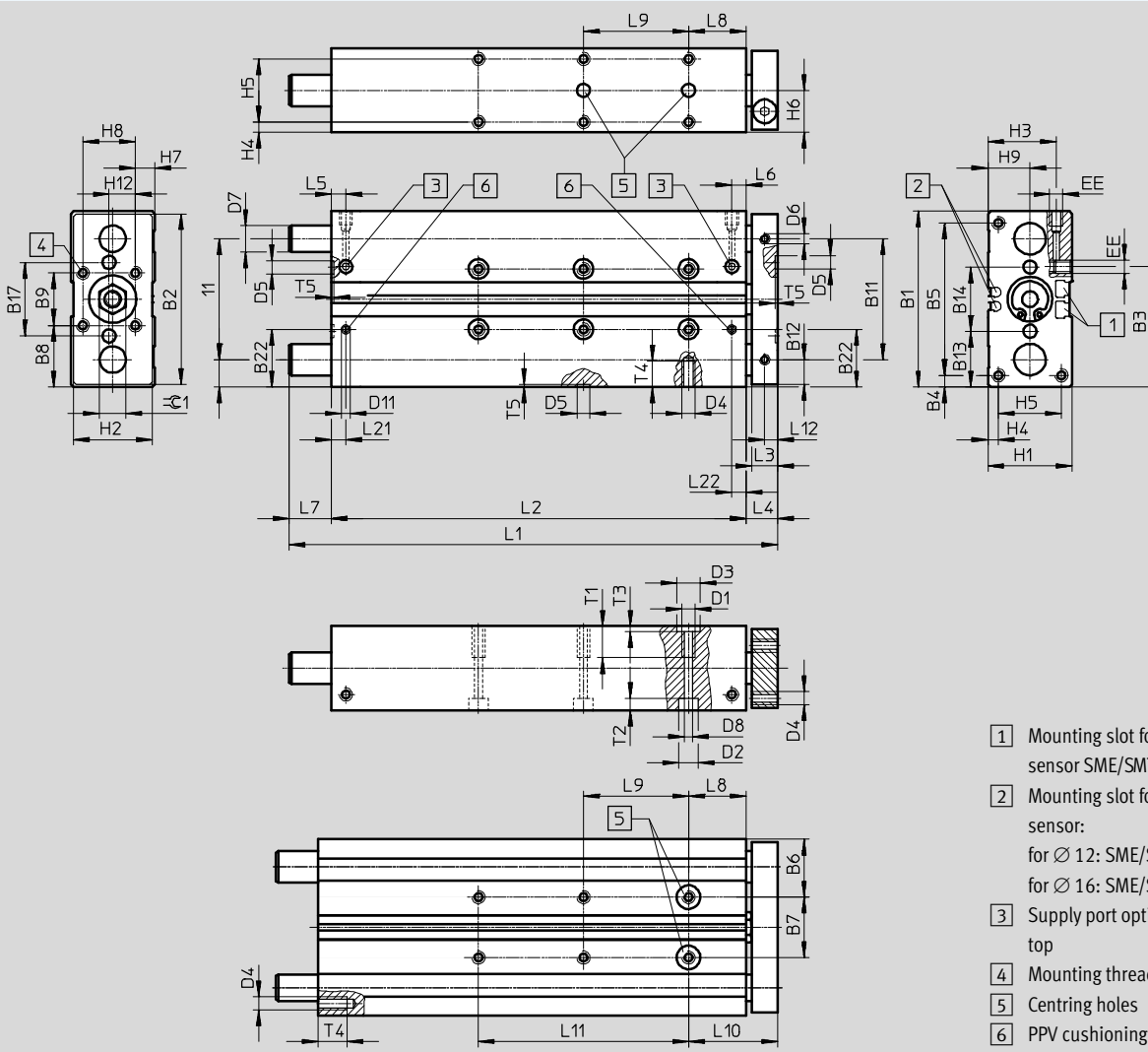

- 1 Mounting slot for proximity sensor SME/SMT-8
- 2 Mounting slot for proximity sensor:
for Ø 12: SME/SMT-10
for Ø 16: SME/SMT-8
- 3 Supply port options on side or top
- 4 Mounting thread
- 5 Centring holes
- 6 PPV cushioning

Ø	B1	B2	B3	B4	B5	B6	B7	B8	B9	B10	B11	B12	B13	B14	B17	B22	D1
[mm]							±0.02 ¹⁾							±0.02 ¹⁾			
12	60	58	44.2	4.5	51	20.5	19	20	20	9.5	41	8.5	19.5	21	25	–	M5
16	67	65	45	4.5	58	22	23	23.5	20	10.5	46	9.5	21.3	24.4	28	22.5	M5

1) Tolerance between the centring holes

Ø	D2	D3	D4	D5	D6	D7		D8	D11	EE	H1	H2	H3	H4	H5	H6	H7
	Ø	Ø		Ø	Ø	GF	KF	Ø	Ø								
[mm]		H7		H7				H7									
12	8	9	M4	5	M4	10 _{h8}	8 _{h6}	4.3	–	M5	28	26	24	4	20	14	4
16	7.5	9	M5	5	M4	12 _{h8}	10 _{h6}	4.3	3.3	M5	32	30	26.5	4	24	16	7.4

Ø	H8	H9	H12	L3	L4	L5	L6	L8	L10	L12	L21	L22	T1	T2	T3	T4	T5	≈±1
[mm]																		
12	20	14	10	10	13	14.6	10.8	21	34	5	–	–	10	9.4	2.1	8	1.2	10
16	20	16	10	10	12	9.8	9.3	22	34	5	9.8	9.3	12	4.6	2.1	10	1.2	10

Guided drives DFM-B

Technical data

Stroke [mm]	Piston Ø [mm]									
	12					16				
	L1	L2	L7	L9 ±0.02 ¹⁾	L11	L1	L2	L7	L9 ±0.02 ¹⁾	L11
10	74	50	11	-	-	80	68	-	-	-
20	84	60	11	-	-	90	78	-	-	-
25	89	65	11	20	-	95	83	-	20	-
30	94	70	11	20	-	100	88	-	20	-
40	104	80	11	20	-	110	98	-	20	-
50	114	90	11	40	-	120	108	-	40	-
80	144	120	11	40	-	150	138	-	40	-
100	164	140	11	40	80	170	158	-	40	80
125	230	165	52	40	80	229	183	34	40	80
160	265	200	52	40	120	264	218	34	40	120
200	305	240	52	40	160	304	258	34	40	160

1) Tolerance between the centring holes

 Note

If the guide rods project beyond the contour of the housing in the retracted position (→ dimension L7), when the unit is mounted on its end face an appropriate recess must be provided in the mounting surface so that the guide rods can move freely.

When using a variable stroke, the dimensions L1, L2, L7, L9 and L11 correspond to the next longest standard stroke.

Dimensions Download CAD data → www.festo.com

AJ – Precision stroke adjustment, advanced end position
 Ø 12, 16 mm

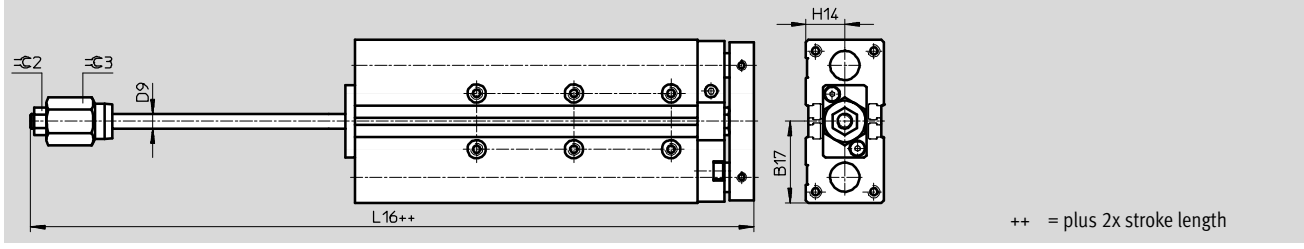

Ø	B17	D9 Ø	H14	L16	C2	C3
[mm]						
12	30.5	6	14	90.6	10	17
16	33.5	6	16	107.9	10	17

Guided drives DFM-B

Technical data

∅	B1	B2	B3	B4	B5	B6	B7	B8	B9	B10	B11	B12	B13	B14	B15	B22	D1
[mm]							±0.02 ¹⁾		±0.02 ¹⁾								
20	83	81	70	6.5	70	26.5	30	26.5	30	12.5	58	6.5	68	31.5	18	28	M6
25	95	93	69	15.5	64	30	35	27.5	40	13.5	68	12.5	68	32.5	28	32	M6
32	110	108	79.5	20	70	33.5	43	35	40	16	78	15	78	41	26	38	M8
40	120	118	85.5	15	90	34.5	51	35	50	16	88	15	88	41	36	41.5	M8

1) Tolerance between the centring holes

∅	D2 ∅	D3 ∅ H7	D4	D5 ∅ H7	D6 ∅	D7 ∅		D8 ∅ H7	D11 ∅	EE	H1	H2	H3	H4	H5	H6	H7
						GF	KF										
20	9	9	M5	9	M5	14	12	7	8.5	M5	36	34	28.5	4.5	27	18	7
25	9	9	M6	9	M6	16	14	7	8.8	G1/8	44	42	34	4.5	35	22	12
32	11	12	M6	9	M6	20	16	9	8.8	G1/8	49	47	37	6	37	24.5	8.5
40	11	12	M8	9	M6	20	16	9	8.8	G1/8	54	52	41.5	6	42	27	10

∅	H8	H9	L3	L4	L5	L8	L10	L12	L21	T1	T2	T3	T4	T5	T6	T7	≈±1
[mm]																	
20	20	16.5	12	14	6	26	40	6	6	12	5.7	2.1	10	2.1	1.6	11	14
25	20	19	12	14	8.5	26	40	6	8.5	15	5.7	2.1	12	2.1	1.6	15	17
32	30	21	14	16	9	29	45	7	9	20	6.8	2.6	11	2.1	2.1	15	17
40	30	26	14	16	8.5	29	45	7	9.5	20	6.8	2.6	16	2.1	2.1	15	17

Stroke [mm]	Piston ∅ [mm]																			
	20					25					32					40				
	L1	L2	L7	L9 ±0.02 ¹⁾	L11	L1	L2	L7	L9 ±0.02 ¹⁾	L11	L1	L2	L7	L9 ±0.02 ¹⁾	L11	L1	L2	L7	L9 ±0.02 ¹⁾	L11
20	105	82	9	20	-	111	90	7	20	-	118	95	7	20	-	-	-	-	-	-
25	110	87				116	95				123	100				123	101	6	20	
30	115	92	19	-	-	121	100	17	-	-	133	105	12	-	-	-	-	-	-	-
40	135	102				141	110				143	115				153	125	153	126	
50	145	112	29	-	-	151	120	32	-	-	153	125	37	-	-	208	156	36	-	-
80	185	142				196	150				208	155				208	156			
100	205	162	56	40	80	216	170	62	40	80	228	175	67	40	80	228	176	66	40	80
125	257	187				271	195				283	200				283	201			
160	292	222	146	-	-	120	306	230	142	-	120	318	235	142	-	120	318	236	141	140
200	332	262				160	346	270			160	358	275			160	358	276		
250	472	312	-	-	-	200	476	320	-	-	200	483	325	-	-	200	483	326	-	-
320	542	382				240	546	390			240	553	395			240	553	396		
400	622	462	-	-	-	320	626	470	-	-	320	633	475	-	-	320	633	476	-	-

1) Tolerance between the centring holes

- ± - Note: This product conforms to ISO 1179-1 and to ISO 228-1

Note

If the guide rods project beyond the contour of the housing in the retracted position (→ dimension L7), when the unit is mounted on its end face an appropriate recess must be provided in the mounting surface so that the guide rods can move freely.

When using a variable stroke, the dimensions L1, L2, L7, L9 and L11 correspond to the next longest standard stroke.

Guided drives DFM-B

Technical data

Dimensions

Download CAD data → www.festo.com

YSRW – Self-adjusting cushioning

∅ 20 ... 40 mm

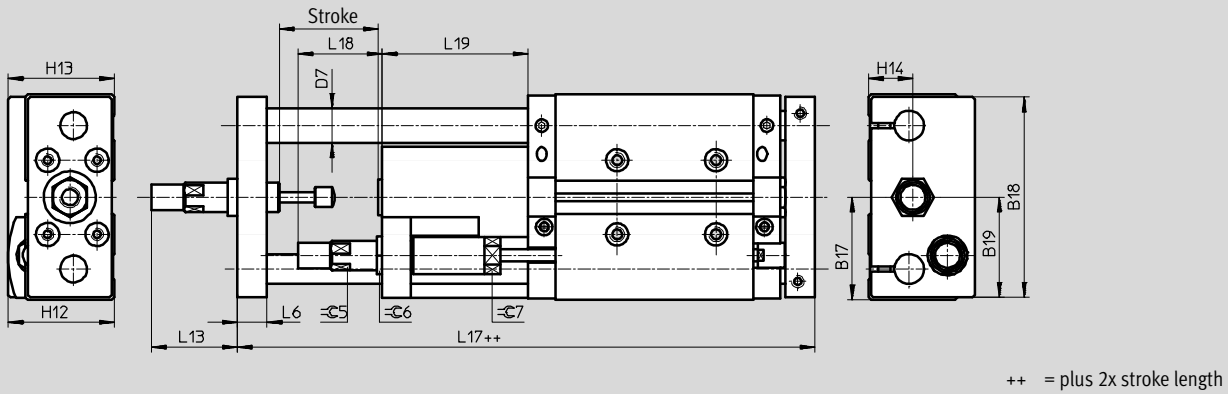

AJ/EJ – Precision stroke adjustment, advanced end position and retracted end position

∅ 20 ... 40 mm

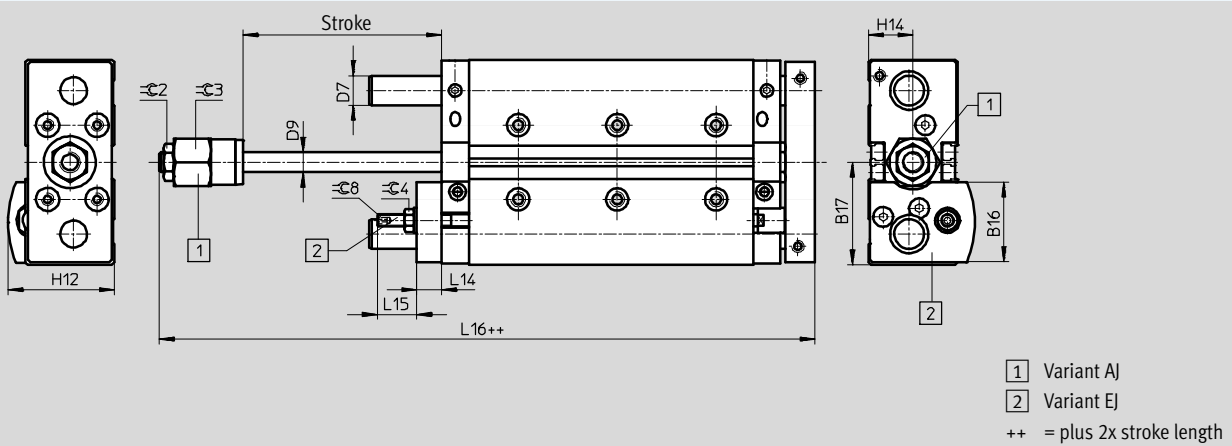

Guided drives DFM-B

Technical data

∅ [mm]	B16	B17	B18	B19	D7 ∅		D9 ∅	H12	H13	H14	L6	L13	L14
					GF	KF							
20	32.5	41.5	81	40.5	14	12	8	43	43	18	12	36.5	10
25	38.6	47.5	90	45	16	14	10	49.5	50.5	22	14	43	12
32	43.4	55	105	52.5	20	16	12	56.5	56	24.5	16	52	12
40	46.2	60	116	58	20	16	12	62.5	63.5	27	16	72	12

∅ [mm]	L15	L16	L17	L18	L19	≈C2	≈C3	≈C4	≈C5	≈C6	≈C7	≈C8
20	16	110	153.5	34	59	13	19	8	11	15	13	2.5
25	23.5	119.5	176.5	37.5	71	17	24	13	13	17	16	4
32	18.5	129.5	190.5	48.5	76	17	30	13	15	17	19	4
40	18.5	132	209.5	55.5	95	17	30	13	20	22	27	4

Guided drives DFM-B

Technical data

FESTO

Dimensions

∅ 50 ... 63 mm

Download CAD data → www.festo.com

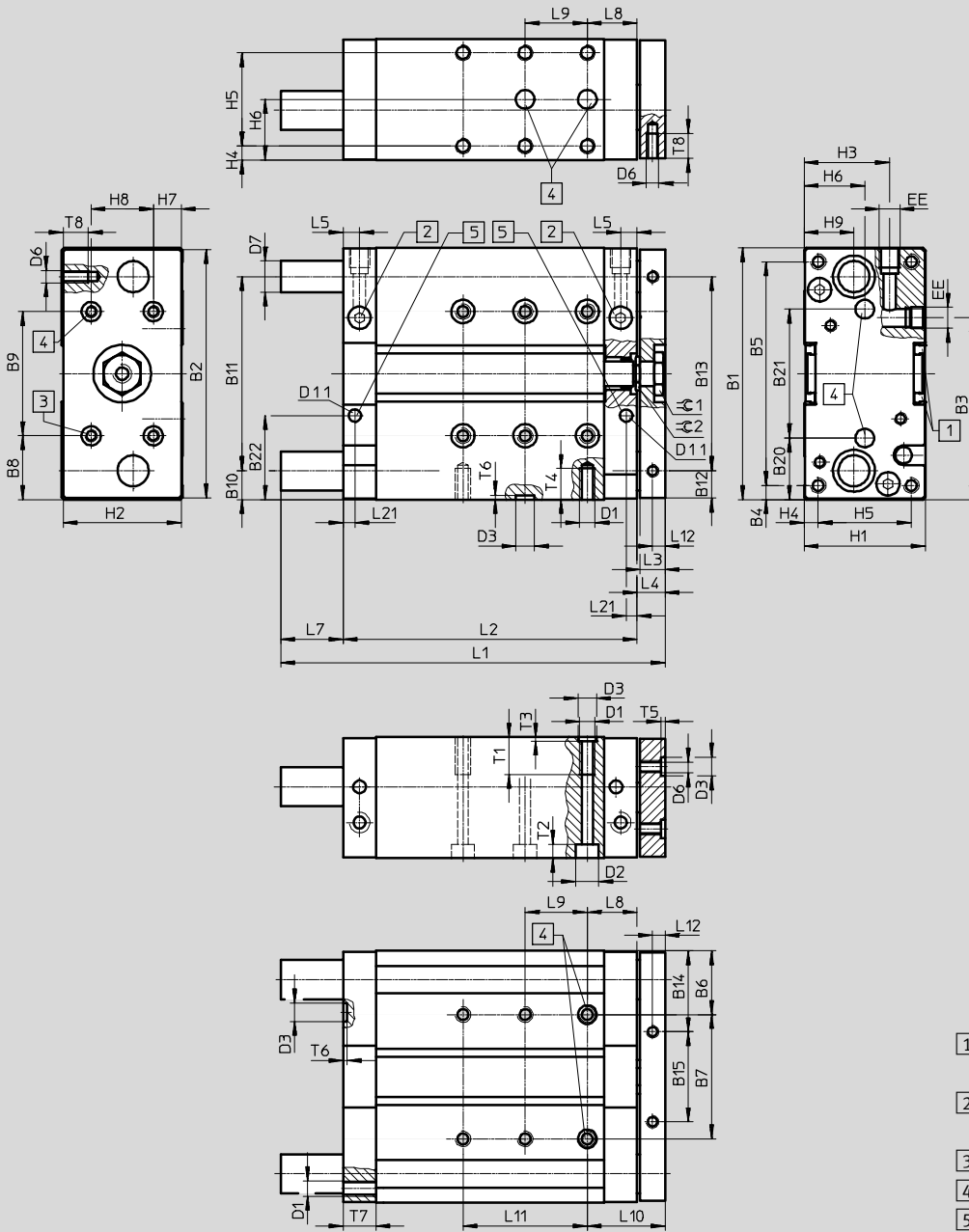

- 1 Mounting slot for proximity sensor
- 2 Supply port options on side or top
- 3 Mounting thread
- 4 Centring holes
- 5 PPV cushioning

Guided drives DFM-B

Technical data

∅	B1	B2	B3	B4	B5	B6	B7	B8	B9	B10	B11	B12	B13	B14	B15	B20	B21
[mm]							±0.02 ¹⁾		±0.02 ¹⁾								±0.02 ¹⁾
50	148	146	104	19	110	42	64	44	60	19	110	18	110	52	42	40	68
63	162	160	116.5	9	144	41	80	41	80	18.5	125	17.5	125	51	58	39.5	83

∅	B22	D1	D2	D3	D6	D7		D11	EE	H1	H2	H3	H4	H5	H6	H7	H8
[mm]			∅	∅	∅	∅		∅									
				H7		GF	KF										
50	52	M8	11	12	M8	25	20	8.8	G1/4	64	62	48.5	7	50	32	12	40
63	53.5	M10	15	12	M8	25	20	8.8	G1/4	78	76	54.5	9	60	39	19	40

∅	H9	L3	L4	L5	L8	L10	L12	L21	T1	T2	T3	T4	T5	T6	T7	T8	≙1	≙2
[mm]																		
50	29	16	18	11.5	32	50	8	11.5	20	6.8	2.6	16	2.6	2.6	21	16	24	19
63	32	16	18	10.5	32	50	8	10.5	24	9	2.6	20	2.6	2.6	21	16	24	19

Stroke	Piston ∅ [mm]									
	50					63				
[mm]	L1	L2	L7	L9	L11	L1	L2	L7	L9	L11
				±0.02 ¹⁾					±0.02 ¹⁾	
25	137	113	6	20	-	137	114	5	20	-
50	177	138	21	41		177	139	20	40	
80	227	168	62		40	227	169	61		40
100	247	188		139		40	247		189	
125	293	213	139		40		293	214	138	320
160	328	248		139		40	120	328		
200	368	288	139		40		160	368	289	138
250	495	338		139		40	200	495	339	
320	565	408	139		40		240	565	409	138
400	645	488		139		40	320	645	489	

1) Tolerance between the centring holes

≙ - Note: This product conforms to ISO 1179-1 and to ISO 228-1

 Note

Since the guide rods project beyond the contour of the housing in the retracted position (→ dimension L7), when the unit is mounted on its end face an appropriate recess must be provided in the mounting surface so that the guide rods can move freely.

When using a variable stroke, the dimensions L1, L2, L7, L9 and L11 correspond to the next longest standard stroke.

Guided drives DFM-B

Technical data



Dimensions

Download CAD data → www.festo.com

YSRW – Self-adjusting cushioning

∅ 50 ... 63 mm

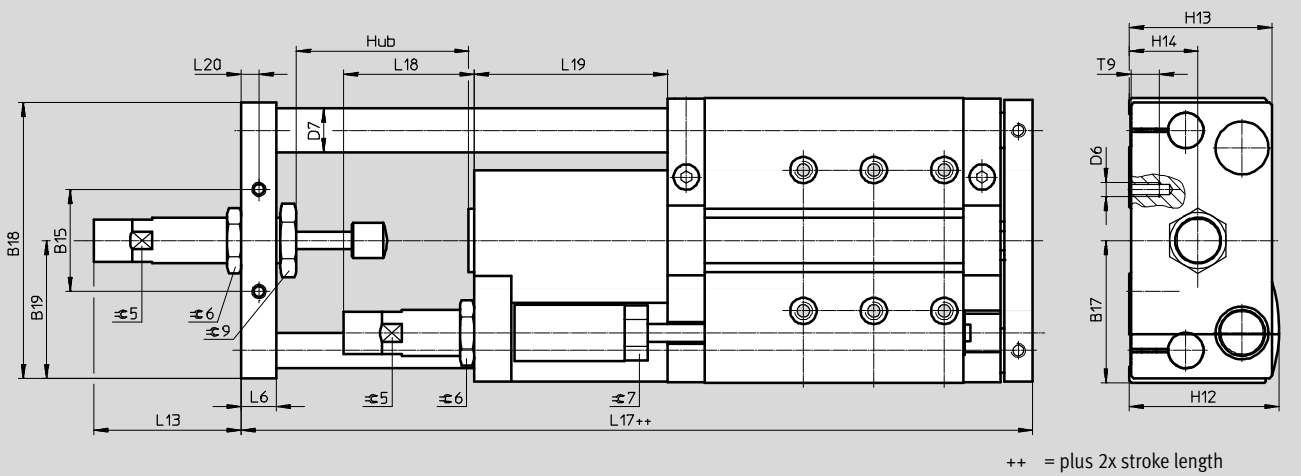

AJ/EJ – Precision stroke adjustment, advanced end position and retracted end position

∅ 50 ... 63 mm

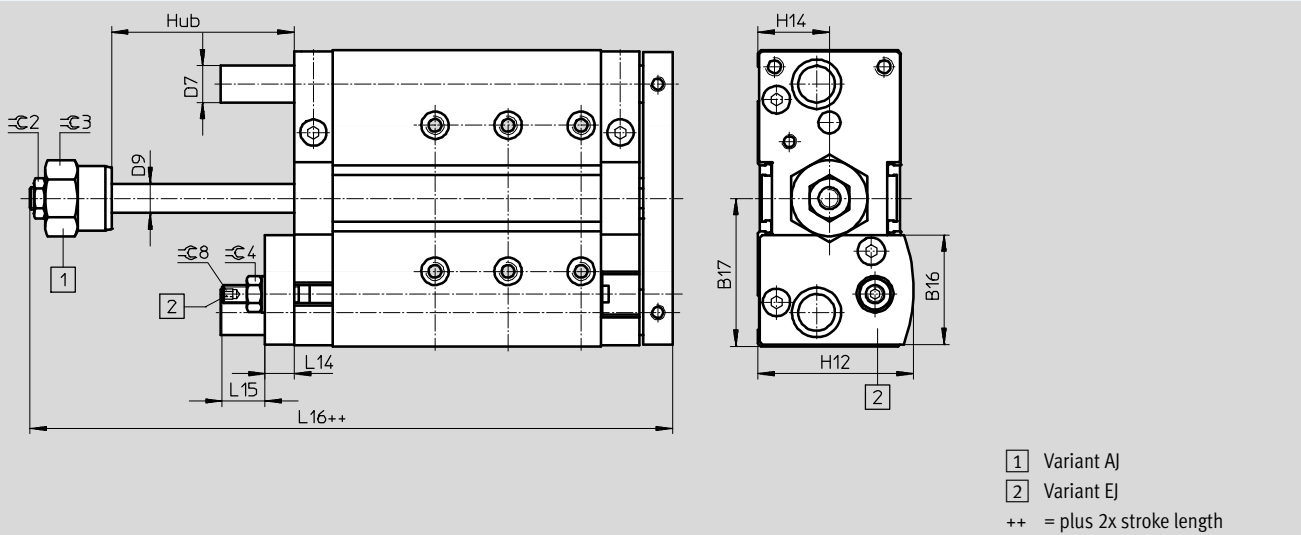

Guided drives DFM-B

Technical data

∅ [mm]	B15	B16	B17	B18	B19	D6	D7 ∅		D9 ∅	H12	H13	H14	L6	L13	L14
							GF	KF							
50	42	57.6	74	144	72	M8	25	20	16	74	71	32	16	67.6	16
63	58	60	81	157	78.5	M8	25	20	16	81	81	39	20	83.3	16

∅ [mm]	L15	L16	L17	L18	L19	L20	T9	≈C2	≈C3	≈C4	≈C5	≈C6	≈C7	≈C8	≈C9
63	23.5	151.8	249.2	74	110	10	16	19	36	17	24	32	27	5	36

Guided drives DFM-B, with plain-bearing guide GF

Ordering data – Modular products

Ordering table												
Size	12	16	20	25	32	40	50	63	Condi- tions	Code	Entry code	
M Module no.	529119	529120	532316	532317	532318	532319	534769	534770				
Function	Guided drives									DFM	DFM	
Piston Ø [mm]	12	16	20	25	32	40	50	63		-...		
Stroke [mm]	10	10	-	-	-	-	-	-		-...		
	20	20	20	20	20	-	-	-		-...		
	25	25	25	25	25	25	25	25		-...		
	30	30	30	30	30	-	-	-		-...		
	40	40	40	40	40	-	-	-		-...		
	50	50	50	50	50	50	50	50		-...		
	80	80	80	80	80	80	80	80		-...		
	100	100	100	100	100	100	100	100		-...		
	125	125	125	125	125	125	125	125		-...		
	160	160	160	160	160	160	160	160		-...		
	200	200	200	200	200	200	200	200		-...		
	-	-	250	250	250	250	250	250	250		-...	
	-	-	320	320	320	320	320	320	320		-...	
-	-	400	400	400	400	400	400	400		-...		
Variable stroke [mm]	10 ... 200		20 ... 400			25 ... 400			1	-...		
Generation	B series									-B	-B	
Cushioning	Elastic cushioning rings/pads at both ends									-P		
	- Pneumatic cushioning, adjustable at both ends									2	-PPV	
Position sensing	For proximity sensor									-A	-A	
Guidance	Plain-bearing guide									-GF	-GF	

1 ... Not with precision adjustment AJ.

2 PPV Not with precision adjustment AJ, EJ.

- M** Mandatory data
- O** Options

Transfer order code

	DFM	-		-		-	B	-		-	A	-	GF
--	------------	---	--	---	--	---	----------	---	--	---	----------	---	-----------

Guided drives DFM-B, with plain-bearing guide GF

Ordering data – Modular products

Ordering table											
Size	12	16	20	25	32	40	50	63	Condi- tions	Code	Entry code
<input type="checkbox"/> Thermal resistance	Heat-resistant seals up to max. 120 °C								<input type="checkbox"/>	S6	
<input type="checkbox"/> Precision adjustment advancing	Precision adjustment into the end positions, advancing									-AJ	
<input type="checkbox"/> Precision adjustment retracting	-	-	Precision adjustment into the end positions, retracting							-EJ	
<input type="checkbox"/> Accessories	Supplied separately									ZUB-	ZUB-
<input type="checkbox"/> Slot cover for sensor slot	1 ... 10									...S	
<input type="checkbox"/> Proximity sensors	With cable, 2.5 m									...G	
	Non-contacting with cable, 2.5 m									...I	

S6 Not with precision adjustment AJ, EJ.

- Mandatory data
- Options

Transfer order code

- - - **ZUB** -

Guided drives DFM-B, with recirculating ball bearing guide KF

Ordering data – Modular products

Ordering table												
Size	12	16	20	25	32	40	50	63	Conditions	Code	Entry code	
M Module no.	529119	529120	532316	532317	532318	532319	534769	534770				
Function	Guided drives									DFM	DFM	
Piston Ø [mm]	12	16	20	25	32	40	50	63		-...		
Stroke [mm]	10	10	-	-	-	-	-	-		-...		
	20	20	20	20	20	-	-	-		-...		
	25	25	25	25	25	25	25	25		-...		
	30	30	30	30	30	-	-	-		-...		
	40	40	40	40	40	-	-	-		-...		
	50	50	50	50	50	50	50	50		-...		
	80	80	80	80	80	80	80	80		-...		
	100	100	100	100	100	100	100	100		-...		
	125	125	125	125	125	125	125	125		-...		
	160	160	160	160	160	160	160	160		-...		
	200	200	200	200	200	200	200	200		-...		
	-	-	250	250	250	250	250	250	250		-...	
	-	-	320	320	320	320	320	320	320		-...	
-	-	400	400	400	400	400	400	400		-...		
Variable stroke [mm]	10 ... 200		20 ... 400			25 ... 400			1	-...		
Generation	B series									-B	-B	
Cushioning	Elastic cushioning rings/pads at both ends									-P		
	-	Pneumatic cushioning, adjustable at both ends								2	-PPV	
	-	Shock absorber, self-adjusting, progressive								3	-YSRW	
Position sensing	For proximity sensor									-A	-A	
Guidance	Recirculating ball bearing guide									-KF	-KF	

1 ... Not with precision adjustment AJ, cushioning YSRW.
2 PPV Not with precision adjustment AJ, EJ.

3 YSRW Not with precision adjustment AJ, EJ, as already integrated.

- M** Mandatory data
- O** Options

Transfer order code

DFM - - - **B** - - **A** - - **KF**

Guided drives DFM-B, with recirculating ball bearing guide KF

Ordering data – Modular products

Ordering table											
Size	12	16	20	25	32	40	50	63	Condi- tions	Code	Entry code
<input type="checkbox"/> Precision adjustment advancing	Precision adjustment into the end positions, advancing									-AJ	
<input type="checkbox"/> Precision adjustment retracting	-	-	Precision adjustment into the end positions, retracting							-EJ	
<input type="checkbox"/> Accessories	Supplied separately									ZUB-	ZUB-
<input type="checkbox"/> Slot cover for sensor slot	1 ... 10									...S	
<input type="checkbox"/> Proximity sensors With cable, 2.5 m	1 ... 10									...G	
<input type="checkbox"/> Non-contacting with cable, 2.5 m	1 ... 10									...I	

- Mandatory data
- Options

Transfer order code

- - ZUB -

Guided drives DFM/DFM-B

Accessories



Centring sleeve ZBH

Materials:
High-alloy steel

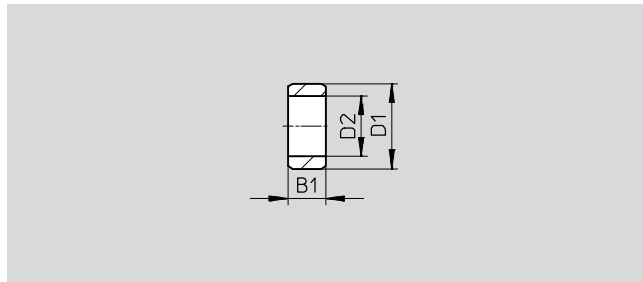

Dimensions and ordering data (repeat order)							
B1	D1	D2	CRC ¹⁾	Weight	Part No.	Type	PU ²⁾
-0.2	∅ H7	∅		[g]			
2.4	5	3.2	2	1	189652	ZBH-5	10
3	7	5.3	2	1	186717	ZBH-7	10
4	9	6.4	2	1	150927	ZBH-9	10
5	12	10.3	2	1	189653	ZBH-12	10
6	15	12.4	2	1	191409	ZBH-15	10

- 1) Corrosion resistance class CRC 2 to Festo standard FN 940070
Moderate corrosion stress. Indoor applications in which condensation may occur. External visible parts with primarily decorative requirements for the surface and which are in direct contact with the ambient atmosphere typical for industrial applications.
- 2) Packaging unit

Centring sleeves included in the scope of delivery			
DFM	Piston ∅ [mm]	Centring sleeves	
		For housing	For yoke plate
	12	2x ZBH-5, 2x ZBH-9	2x ZBH-5
	16	2x ZBH-5, 2x ZBH-9	2x ZBH-5
	20	2x ZBH-7, 2x ZBH-9	2x ZBH-9
	25	2x ZBH-7, 2x ZBH-9	2x ZBH-9
	32	2x ZBH-9, 2x ZBH-12	2x ZBH-9
	40	2x ZBH-9, 2x ZBH-12	2x ZBH-9
	50	2x ZBH-12	2x ZBH-12
	63	2x ZBH-12	2x ZBH-12
	80	2x ZBH-12	2x ZBH-12
	100	2x ZBH-15	2x ZBH-15

Centring sleeves included in the scope of delivery			
DFM-B	Piston ∅ [mm]	Centring sleeves	
		For housing	For yoke plate
	12	2x ZBH-5, 2x ZBH-9	2x ZBH-5
	16	2x ZBH-5, 2x ZBH-9	2x ZBH-5
	20	2x ZBH-7, 2x ZBH-9	2x ZBH-9
	25	2x ZBH-7, 2x ZBH-9	2x ZBH-9
	32	2x ZBH-9, 2x ZBH-12	2x ZBH-9
	40	2x ZBH-9, 2x ZBH-12	2x ZBH-9
	50	2x ZBH-12	2x ZBH-12
	63	2x ZBH-12	2x ZBH-12
	-	-	-
	-	-	-

Proximity sensor for piston ∅ 6, 10 on DFM						
Ordering data – Proximity sensors for C-slot, magneto-resistive						Technical data → Internet: smt
	Type of mounting	Switching output	Electrical connection, outlet direction	Cable length [m]	Part No.	Type
	Insertable into the slot lengthwise	PNP	Cable, 3-wire, lateral	2.5	547862	SMT-10G-PS-24V-E-2,5Q-OE
			Plug connector M8x1, 3-pin, lateral	0.3	547863	SMT-10G-PS-24V-E-0,3Q-M8D
		NPN	Cable, 3-wire, lateral	2.5	8065030	SMT-10G-NS-24V-E-2,5Q-OE
			Plug connector M8x1, 3-pin, lateral	0.3	8065029	SMT-10G-NS-24V-E-0,3Q-M8D

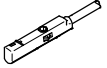

Guided drives DFM/DFM-B

Accessories

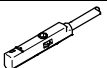
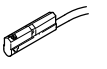
Proximity sensor for piston \varnothing 12 on DFM-B						
Ordering data – Proximity sensors for C-slot, magneto-resistive						Technical data → Internet: smt
	Type of mounting	Switching output	Electrical connection, outlet direction	Cable length [m]	Part No.	Type
N/O contact						
	Insertable in the slot from above	PNP	Cable, 3-wire, lengthwise	2.5	★ 551373	SMT-10M-PS-24V-E-2,5-L-OE
			Plug connector M8x1, 3-pin, in-line	0.3	★ 551375	SMT-10M-PS-24V-E-0,3-L-M8D
			Plug connector M8x1, 3-pin, lateral	0.3	551376	SMT-10M-PS-24V-E-0,3-Q-M8D

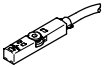
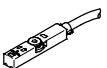
Ordering data – Proximity sensor for C-slot, magnetic reed						
Ordering data – Proximity sensor for C-slot, magnetic reed						Technical data → Internet: sme
	Type of mounting	Switching output	Electrical connection, outlet direction	Cable length [m]	Part No.	Type
N/O contact						
	Insertable in the slot from above	Contacting	Plug connector M8x1, 3-pin, in-line	0.3	★ 551367	SME-10M-DS-24V-E-0,3-L-M8D
			Cable, 3-wire, lengthwise	2.5	★ 551365	SME-10M-DS-24V-E-2,5-L-OE
			Cable, 2-wire, lengthwise	2.5	★ 551369	SME-10M-ZS-24V-E-2,5-L-OE
	Insertable into the slot lengthwise	Contacting	Plug connector M8x1, 3-pin, in-line	0.3	173212	SME-10-SL-LED-24
			Cable, 3-wire, lengthwise	2.5	173210	SME-10-KL-LED-24

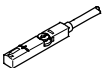
Proximity sensors for piston \varnothing 12 ... 100						
Ordering data – Proximity sensor for T-slot, magneto-resistive						Technical data → Internet: smt
	Type of mounting	Switching output	Electrical connection	Cable length [m]	Part No.	Type
N/O contact						
	Insertable in the slot from above, flush with the cylinder profile, short design	PNP	Cable, 3-wire	2.5	★ 574335	SMT-8M-A-PS-24V-E-2,5-OE
			Plug connector M8x1, 3-pin	0.3	★ 574334	SMT-8M-A-PS-24V-E-0,3-M8D
			Plug connector M12x1, 3-pin	0.3	★ 574337	SMT-8M-A-PS-24V-E-0,3-M12
		NPN	Cable, 3-wire	2.5	★ 574338	SMT-8M-A-NS-24V-E-2,5-OE
			Plug connector M8x1, 3-pin	0.3	★ 574339	SMT-8M-A-NS-24V-E-0,3-M8D
N/C contact						
	Insertable in the slot from above, flush with the cylinder profile, short design	PNP	Cable, 3-wire	7.5	★ 574340	SMT-8M-A-PO-24V-E-7,5-OE

Ordering data – Proximity sensors for T-slot, magnetic reed						
Ordering data – Proximity sensors for T-slot, magnetic reed						Technical data → Internet: sme
	Type of mounting	Switching output	Electrical connection	Cable length [m]	Part No.	Type
N/O contact						
	Insertable in the slot from above, flush with the cylinder profile	Contacting	Cable, 3-wire	2.5	★ 543862	SME-8M-DS-24V-K-2,5-OE
				5.0	★ 543863	SME-8M-DS-24V-K-5,0-OE
			Cable, 2-wire	2.5	★ 543872	SME-8M-ZS-24V-K-2,5-OE
			Plug connector M8x1, 3-pin	0.3	★ 543861	SME-8M-DS-24V-K-0,3-M8D
	Insertable in the slot lengthwise, flush with the cylinder profile	Contacting	Cable, 3-wire	2.5	150855	SME-8-K-LED-24
			Plug connector M8x1, 3-pin	0.3	150857	SME-8-S-LED-24
N/C contact						
	Insertable in the slot lengthwise, flush with the cylinder profile	Contacting	Cable, 3-wire	7.5	160251	SME-8-O-K-LED-24



Festo core product range

- ★ Generally ready for shipping ex works in 24 hours
- ☆ Generally ready for shipping ex works in 5 days

Guided drives DFM/DFM-B

Accessories

FESTO

Ordering data – Connecting cables				Technical data → Internet: nebu	
	Electrical connection, left	Electrical connection, right	Cable length [m]	Part No.	Type
	Straight socket, M8x1, 3-pin	Cable, open end, 3-wire	2.5	★ 541333	NEBU-M8G3-K-2.5-LE3
			5	★ 541334	NEBU-M8G3-K-5-LE3
	Straight socket, M12x1, 5-pin	Cable, open end, 3-wire	2.5	★ 541363	NEBU-M12G5-K-2.5-LE3
			5	★ 541364	NEBU-M12G5-K-5-LE3
	Angled socket, M8x1, 3-pin	Cable, open end, 3-wire	2.5	★ 541338	NEBU-M8W3-K-2.5-LE3
			5	★ 541341	NEBU-M8W3-K-5-LE3
	Angled socket, M12x1, 5-pin	Cable, open end, 3-wire	2.5	541367	NEBU-M12W5-K-2.5-LE3
			5	541370	NEBU-M12W5-K-5-LE3

Ordering data – Slot cover for T-slot			
	Mounting	Length	Part No. Type
	Insertable	2x 0.5 m	151680 ABP-5-S

Ordering data – One-way flow control valves				Technical data → Internet: grla	
	Connection		Material	Part No.	Type
	Thread	For tubing O.D.			
	M3	–	Metal design	175038	GRLA-M3
		3		175041	GRLA-M3-QS-3
	M5	3		★ 193137	GRLA-M5-QS-3-D
		4		★ 193138	GRLA-M5-QS-4-D
		6		★ 193139	GRLA-M5-QS-6-D
	G1/8	3		★ 193142	GRLA-1/8-QS-3-D
		4		★ 193143	GRLA-1/8-QS-4-D
		6		★ 193144	GRLA-1/8-QS-6-D
		8		★ 193145	GRLA-1/8-QS-8-D
		10		★ 193146	GRLA-1/4-QS-6-D
	G1/4	6		★ 193147	GRLA-1/4-QS-8-D
		8		★ 193148	GRLA-1/4-QS-10-D
		10		★ 193149	GRLA-3/8-QS-6-D
	G3/8	6		★ 193150	GRLA-3/8-QS-8-D
		8		★ 193151	GRLA-3/8-QS-10-D
		10			

Festo core product range

★ Generally ready for shipping ex works in 24 hours

☆ Generally ready for shipping ex works in 5 days

Guided drives DFM/DFM-B

Accessories

Adapter kit
DHAA, HAPB

Materials:
Wrought aluminium alloy
Free of copper and PTFE
RoHS compliant

 Note
The kit includes the individual mounting interface as well as the necessary mounting material.

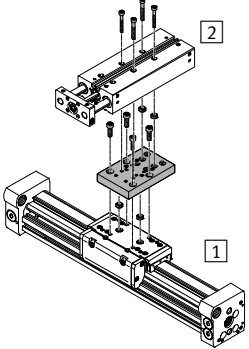
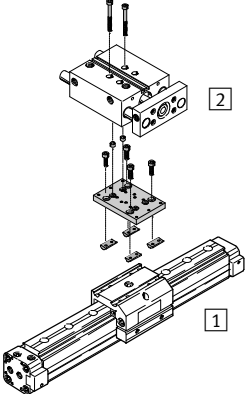
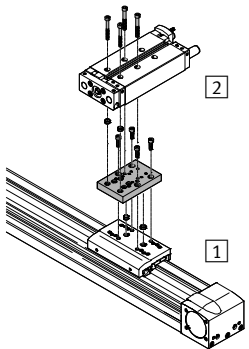
Permissible drive/drive combinations with adapter kit				Download CAD data → www.festo.com	
Combination	[1] Drive	[2] Drive	Adapter kit		
	Size	Size	CRC ¹⁾	Part No.	Type
DGC/DFM	DGC	DFM	DHAA		
	25	12, 16, 20	2	562152	DHAA-D-L-25-G7-12
	32	20, 25		562153	DHAA-D-L-32-G7-20
	40	25, 32, 40		562154	DHAA-D-L-40-G7-25
DGPL, DGE/DFM	DG...	DFM	HAPB		
	25	12, 16	2	192690	HAPB-12/16
	32 ²⁾	20, 25		192691	HAPB-20/25
	40	32, 40		192692	HAPB-32/40
EGC/DFM	EGC	DFM	DHAA		
	80	12, 16, 20	2	562152	DHAA-D-L-25-G7-12
	120	25, 32, 40		562154	DHAA-D-L-40-G7-25

1) Corrosion resistance class CRC 2 to Festo standard FN 940070
Moderate corrosion stress. Indoor applications in which condensation may occur. External visible parts with primarily decorative requirements for the surface and which are in direct contact with the ambient atmosphere typical for industrial applications.

2) For DGPL only