

No.	Changes and/or Note No.	Date	Intr	No	Changes and/or Note No.	Date	Intr

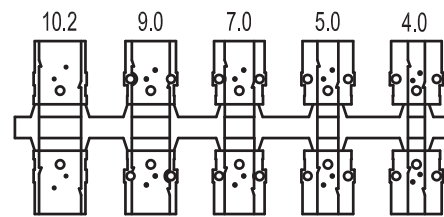
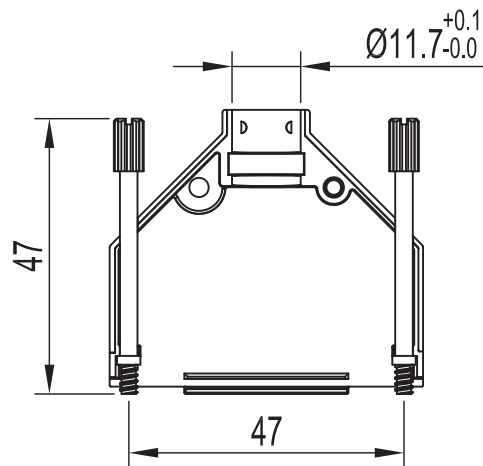
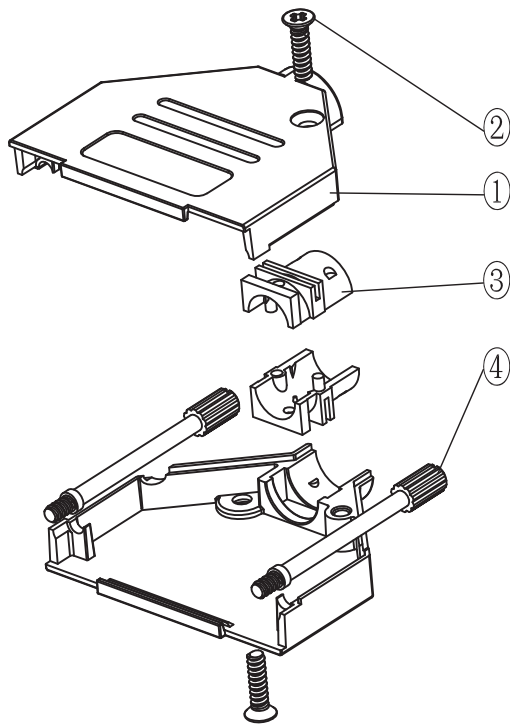
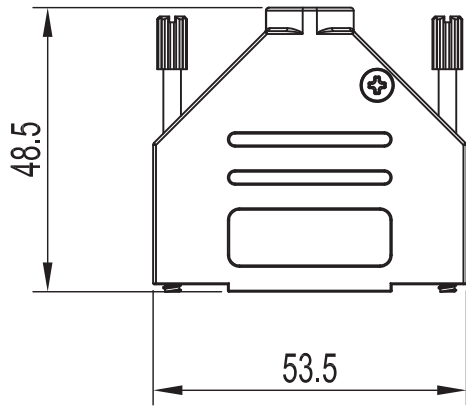

Grommet Set

Part Number:	Description:	Pack:	Item	QTY	Part description
			1	2	DTZK25 Cover
6560-0105-03	DTZK25-K	Kit	2	2	M3X12 Countersunk screw
			3	1	D45ZK-D2 Grommet set
6561-0105-03	DTZK25	Bulk	4	2	UNC 4-40X47 Jackscrew
DATE: 2011-12-12	DRAWN: MRR	SCALE:	MATERIAL TYPE:		GENERAL TOLERANCES UNLESS OTHERWISE STATED LINEAR 0 ±0.2 0.0 ±0.15 0.00 ±0.1 ANGULAR ±0°30' ALL DIMENSIONS IN mm THIRD ANGLE PROJECTION
	APPROVED:		REPLACES:		
		DTZK-SERIES			