

## Long-distance Detection Prevents Unexpected Facility Stoppages

- The world's longest sensing distance\*<sup>1</sup>  
Nearly double the sensing distance of previous
- With high-brightness LED, the indicator is visible anywhere from 360°.
- Only 10 Seconds\*<sup>2</sup> to Replace a Proximity Sensor with the "e-jig" (Mounting Sleeve).
- Cables with enhanced oil resistance enabled 2-year oil resistance\*<sup>3</sup>.
- UL certification (UL60947-5-2) and CSA certification (CSA C22.2 UL60947-5-2-14)

\*1. Based on July 2017 OMRON investigation.  
\*2. Time required to adjust the distance when installing a Sensor. Based on OMRON investigation.  
\*3. Refer to page 20 and 22 for details. However, E2EQ series is excluded.

 Be sure to read *Safety Precautions* on page 28.



For the most recent information on models that have been certified for safety standards, refer to your OMRON website.

## E2E/E2EQ NEXT Series Model Number Legend

### DC 2-wire

E2E (1) - X (2) (3) D (4) (5) (6) - (7) - (8) (9) - (10) (11)

No.	Classification	Code	Meaning
(1)	Case	Blank	Without spatter-resistant coating
		Q	With spatter-resistant coating
(2)	Sensing distance	Number	Sensing distance (Unit: mm) (R: Indication of decimal point)
(3)	Shielding	Blank	Shielded Models
		M	Unshielded Models
(4)	Operation mode	1	Normally open (NO)
		2	Normally closed (NC)
(5)	Body size	Blank	Standard
		L	Long Body
(6)	Size (Omitted for the Single distance type.)	8	M8
		12	M12
		18	M18
		30	M30
(7)	Connecting method	Blank	Pre-wired Models
		M1TGJ	M12 Pre-wired Smartclick Connector Models
		M1TGJR	M12 Pre-wired Smartclick Connector Models (Robot (bending-resistant) PVC cable)
(8)	Polarity	Blank	Polarity
		T	No polarity
(9)	Cable specifications *	Blank	Standard PVC cable
		R	Robot (bending-resistant) PVC cable
(10)	New model	Blank	Other than Single distance model (Pre-wired Models)
		N	Single distance model (Applicable only to Pre-wired Models)
(11)	Cable length	Number M	Cable length

\* (9) is only shown in the model number of Pre-wired Models.

**Note:** 1. The purpose of this model number legend is to provide understanding of the meaning of specifications from the model number. Models are not available for all combinations of code numbers.  
2. Size description of the number 7 is not included in the Single-distance type.

# E2E/E2EQ NEXT Series

## Ordering Information

### Sensors

E2E NEXT Series (Triple distance model)

DC 2-wire [Refer to *Dimensions* on page 30.]

Shielded Models \*1

Size (Sensing distance)	Connection method	Polarity	Model	
			Operation mode: NO	Operation mode: NC
M8 (3 mm)	Pre-wired (2 m) *2 *3	Yes	E2E-X3D18 2M	E2E-X3D28 2M
		No	E2E-X3D18-T 2M	E2E-X3D28-T 2M
	M12 Pre-wired Smartclick Connector (0.3 m) *4	Yes	E2E-X3D18-M1TGJ 0.3M	E2E-X3D28-M1TGJ 0.3M
		No	E2E-X3D18-M1TGJ-T 0.3M	E2E-X3D28-M1TGJ-T 0.3M
M12 (7 mm)	Pre-wired (2 m) *2 *3	Yes	E2E-X7D112 2M	E2E-X7D212 2M
		No	E2E-X7D112-T 2M	E2E-X7D212-T 2M
	M12 Pre-wired Smartclick Connector (0.3 m) *4	Yes	E2E-X7D112-M1TGJ 0.3M	E2E-X7D212-M1TGJ 0.3M
		No	E2E-X7D112-M1TGJ-T 0.3M	E2E-X7D212-M1TGJ-T 0.3M
M18 (11 mm)	Pre-wired (2 m) *2 *3	Yes	E2E-X11D118 2M	E2E-X11D218 2M
		No	E2E-X11D118-T 2M	E2E-X11D218-T 2M
	M12 Pre-wired Smartclick Connector (0.3 m) *4	Yes	E2E-X11D118-M1TGJ 0.3M	E2E-X11D218-M1TGJ 0.3M
		No	E2E-X11D118-M1TGJ-T 0.3M	E2E-X11D218-M1TGJ-T 0.3M
M30 (20 mm)	Pre-wired (2 m) *2 *3	Yes	E2E-X20D130 2M	E2E-X20D230 2M
		No	E2E-X20D130-T 2M	E2E-X20D230-T 2M
	M12 Pre-wired Smartclick Connector (0.3 m) *4	Yes	E2E-X20D130-M1TGJ 0.3M	E2E-X20D230-M1TGJ 0.3M
		No	E2E-X20D130-M1TGJ-T 0.3M	E2E-X20D230-M1TGJ-T 0.3M

### Unshielded Models

Size (Sensing distance)	Connection method	Polarity	Model	
			Operation mode: NO	Operation mode: NC
M8 (6 mm)	Pre-wired (2 m) *2 *3	Yes	E2E-X6MD18 2M	E2E-X6MD28 2M
		No	E2E-X6MD18-T 2M	E2E-X6MD28-T 2M
	M12 Pre-wired Smartclick Connector (0.3 m) *4	Yes	E2E-X6MD18-M1TGJ 0.3M	E2E-X6MD28-M1TGJ 0.3M
		No	E2E-X6MD18-M1TGJ-T 0.3M	E2E-X6MD28-M1TGJ-T 0.3M
M12 (10 mm)	Pre-wired (2 m) *2 *3	Yes	E2E-X10MD112 2M	E2E-X10MD212 2M
		No	E2E-X10MD112-T 2M	E2E-X10MD212-T 2M
	M12 Pre-wired Smartclick Connector (0.3 m) *4	Yes	E2E-X10MD112-M1TGJ 0.3M	E2E-X10MD212-M1TGJ 0.3M
		No	E2E-X10MD112-M1TGJ-T 0.3M	E2E-X10MD212-M1TGJ-T 0.3M
M18 (20 mm)	Pre-wired (2 m) *2 *3	Yes	E2E-X20MD1L18 2M	E2E-X20MD2L18 2M
		No	E2E-X20MD1L18-T 2M	E2E-X20MD2L18-T 2M
	M12 Pre-wired Smartclick Connector (0.3 m) *4	Yes	E2E-X20MD1L18-M1TGJ 0.3M	E2E-X20MD2L18-M1TGJ 0.3M
		No	E2E-X20MD1L18-M1TGJ-T 0.3M	E2E-X20MD2L18-M1TGJ-T 0.3M
M30 (40 mm)	Pre-wired (2 m) *2 *3	Yes	E2E-X40MD1L30 2M	E2E-X40MD2L30 2M
		No	E2E-X40MD1L30-T 2M	E2E-X40MD2L30-T 2M
	M12 Pre-wired Smartclick Connector (0.3 m) *4	Yes	E2E-X40MD1L30-M1TGJ 0.3M	E2E-X40MD2L30-M1TGJ 0.3M
		No	E2E-X40MD1L30-M1TGJ-T 0.3M	E2E-X40MD2L30-M1TGJ-T 0.3M

\*1. When embedding the Proximity Sensor in metal, refer to *Influence of Surrounding Metal* on page 29.

\*2. Models with 5-m cable length are also available with "5M" suffix. (Example: E2E-X3D18 5M)

\*3. Models with 2-m and 5-m robot (bending-resistant) cables are also available with "-R" in the model number. (Example: E2E-X3D18-R 2M/E2E-X3D18-R 5M)

\*4. Models with M12 Pre-wired Smartclick Connectors and robot (bending-resistant) cables are also available with "R" in the model number. (Example: E2E-X3D18-M1TGJR 0.3M/E2E-X3D18-M1TGJR-T 0.3M)

## Sensors

### E2EQ NEXT Series (Spatter-resistant Triple distance model)

DC 2-wire [Refer to *Dimensions* on page 32.]

#### Shielded Models \*1

Size (Sensing distance)	Connection method	Polarity	Model	
			Operation mode: NO	Operation mode: NC
M8 (3 mm)	Pre-wired (2 m) *2	Yes	E2EQ-X3D18 2M	E2EQ-X3D28 2M
		No	E2EQ-X3D18-T 2M	E2EQ-X3D28-T 2M
	M12 Pre-wired Smartclick Connector (0.3 m)	Yes	E2EQ-X3D18-M1TGJ 0.3M	E2EQ-X3D28-M1TGJ 0.3M
		No	E2EQ-X3D18-M1TGJ-T 0.3M	E2EQ-X3D28-M1TGJ-T 0.3M
M12 (7 mm)	Pre-wired (2 m) *2	Yes	E2EQ-X7D112 2M	E2EQ-X7D212 2M
		No	E2EQ-X7D112-T 2M	E2EQ-X7D212-T 2M
	M12 Pre-wired Smartclick Connector (0.3 m)	Yes	E2EQ-X7D112-M1TGJ 0.3M	E2EQ-X7D212-M1TGJ 0.3M
		No	E2EQ-X7D112-M1TGJ-T 0.3M	E2EQ-X7D212-M1TGJ-T 0.3M
M18 (11 mm)	Pre-wired (2 m) *2	Yes	E2EQ-X11D118 2M	E2EQ-X11D218 2M
		No	E2EQ-X11D118-T 2M	E2EQ-X11D218-T 2M
	M12 Pre-wired Smartclick Connector (0.3 m)	Yes	E2EQ-X11D118-M1TGJ 0.3M	E2EQ-X11D218-M1TGJ 0.3M
		No	E2EQ-X11D118-M1TGJ-T 0.3M	E2EQ-X11D218-M1TGJ-T 0.3M
M30 (20 mm)	Pre-wired (2 m) *2	Yes	E2EQ-X20D130 2M	E2EQ-X20D230 2M
		No	E2EQ-X20D130-T 2M	E2EQ-X20D230-T 2M
	M12 Pre-wired Smartclick Connector (0.3 m)	Yes	E2EQ-X20D130-M1TGJ 0.3M	E2EQ-X20D230-M1TGJ 0.3M
		No	E2EQ-X20D130-M1TGJ-T 0.3M	E2EQ-X20D230-M1TGJ-T 0.3M

\*1. When embedding the Proximity Sensor in metal, refer to *Influence of Surrounding Metal* on page 29.

\*2. Models with 5-m cable length are also available with "5M" suffix. (Example: E2EQ-X3D18 5M)

### E2E NEXT Series (Single distance model)

DC 2-wire [Refer to *Dimensions* on page 33.]

#### Shielded Models

Size (Sensing distance)	Connection method	Polarity	Model	
			Operation mode: NO	Operation mode: NC
M8 (1.5 mm)	Pre-wired (2 m) *2 *3	Yes	E2E-X1R5D1-N 2M	E2E-X1R5D2-N 2M
		No	E2E-X1R5D1-T-N 2M	E2E-X1R5D2-T-N 2M
	M12 Pre-wired Smartclick Connector (0.3 m) *4	Yes	E2E-X1R5D1-M1TGJ 0.3M	E2E-X1R5D2-M1TGJ 0.3M
		No	E2E-X1R5D1-M1TGJ-T 0.3M	E2E-X1R5D2-M1TGJ-T 0.3M
M12 (2.5 mm)	Pre-wired (2 m) *2 *3	Yes	E2E-X2R5D1-N 2M	E2E-X2R5D2-N 2M
		No	E2E-X2R5D1-T-N 2M	E2E-X2R5D2-T-N 2M
	M12 Pre-wired Smartclick Connector (0.3 m) *4	Yes	E2E-X2R5D1-M1TGJ 0.3M	E2E-X2R5D2-M1TGJ 0.3M
		No	E2E-X2R5D1-M1TGJ-T 0.3M	E2E-X2R5D2-M1TGJ-T 0.3M
M18 (5 mm)	Pre-wired (2 m) *2 *3	Yes	E2E-X5D1-N 2M	E2E-X5D2-N 2M
		No	E2E-X5D1-T-N 2M	E2E-X5D2-T-N 2M
	M12 Pre-wired Smartclick Connector (0.3 m) *4	Yes	E2E-X5D1-M1TGJ 0.3M	E2E-X5D2-M1TGJ 0.3M
		No	E2E-X5D1-M1TGJ-T 0.3M	E2E-X5D2-M1TGJ-T 0.3M

\*1. Models with 5-m cable length are also available with "5M" suffix. (Example: E2E-X1R5D1-N 5M)

\*2. Models with 2-m and 5-m robot (bending-resistant) cables are also available with "-R" in the model number. (Example: E2E-X1R5D1-R-N 2M/E2E-X1R5D1-R-N 5M)

\*3. Models with M12 Smartclick connector model robot (bending-resistant) cables are also available with "R" in the model number. (Example: E2E-X1R5D1-M1TGJR 0.3M/E2E-X1R5D1-M1TGJR-T 0.3M)

# E2E/E2EQ NEXT Series

## Accessories (Sold Separately)



### Sensor I/O Connectors

(Models for Pre-wired Connectors) A Sensor I/O Connector is not provided with the Sensor. It must be ordered separately as required.  
**Round Oil-resistant Connectors XS5 NEXT series**

Appearance	Cable Specification	Type	Cable diameter (mm)	Cable Connection Direction	Cable length (m)	Sensor I/O Connector model number	Applicable Proximity Sensor model number
 <p>M12 Smartclick Connector Straight type</p>	Oil-resistant PVC cable	Sockets on One Cable End	6 dia.	Straight	1	XS5F-D421-C80-X	E2E-X□D□-M1TGJ(R)(-T) E2EQ-X□D□-M1TGJ(-T)
					2	XS5F-D421-D80-X	
					3	XS5F-D421-E80-X	
					5	XS5F-D421-G80-X	
					10	XS5F-D421-J80-X	
	Oil-resistant PVC robot cable	Sockets on One Cable End	6 dia.	Straight	1	XS5F-D421-C80-XR	
					2	XS5F-D421-D80-XR	
					3	XS5F-D421-E80-XR	
					5	XS5F-D421-G80-XR	
					10	XS5F-D421-J80-XR	
	Oil-resistant PVC cable	Socket and Plug on Cable Ends	6 dia.	Straight (Socket)/ Straight (Plug)	1	XS5W-D421-C81-X	
					2	XS5W-D421-D81-X	
					3	XS5W-D421-E81-X	
					5	XS5W-D421-G81-X	
					10	XS5W-D421-J81-X	
	Oil-resistant PVC robot cable	Socket and Plug on Cable Ends	6 dia.	Straight (Socket)/ Straight (Plug)	1	XS5W-D421-C81-XR	
					2	XS5W-D421-D81-XR	
					3	XS5W-D421-E81-XR	
5					XS5W-D421-G81-XR		
10					XS5W-D421-J81-XR		

**Note:** For details of the connector, refer to *XS5 NEXT Series* on page 87.

### Round Water-resistant Connectors XS5 series

Appearance	Cable Specification	Type	Cable diameter (mm)	Cable Connection Direction	Cable length (m)	Sensor I/O Connector model number	Applicable Proximity Sensor model number			
 <p>M12 Smartclick Connector Straight type</p>  <p>Right-angle type</p>	PVC robot cable	Sockets on One Cable End	6 dia.	Straight	1	XS5F-D421-C80-F	E2E-X□D□-M1TGJ(R)(-T) E2EQ-X□D□-M1TGJ(-T)			
					2	XS5F-D421-D80-F				
					3	XS5F-D421-E80-F				
					5	XS5F-D421-G80-F				
					10	XS5F-D421-J80-F				
				Oil-resistant PVC cable	Socket and Plug on Cable Ends	6 dia.		Right-angle	1	XS5F-D422-C80-F
									2	XS5F-D422-D80-F
									3	XS5F-D422-E80-F
									5	XS5F-D422-G80-F
								Straight (Socket)/ Straight (Plug)	1	XS5W-D421-C81-F
	2	XS5W-D421-D81-F								
	3	XS5W-D421-E81-F								
	5	XS5W-D421-G81-F								
	Right-angle (Socket)/ Right-angle (Plug)	2	XS5W-D422-D81-F							
		5	XS5W-D422-G81-F							
		Straight (Socket)/ Right-angle (Plug)	2	XS5W-D423-D81-F						
			5	XS5W-D423-G81-F						
	Right-angle (Socket)/ Straight (Plug)	2	XS5W-D424-D81-F							
5		XS5W-D424-G81-F								

**Note:** For details of the connector, refer to *XS5 Series* on page 94.

**Sensor I/O Connectors Oil resistance performance of mating combination**

E2E NEXT Series Pre-wired Connector Models	Applicable connector Model	
	XS5 NEXT series	XS5 series
E2E-X□D□-M1TGJ(R)(-T)	2 years of oil resistance*	Water-resistant (IP67)

\* Applicable cutting oil type: specified in JIS K 2241:2000  
 2 years of oil resistance indicates the median value of the product design and the oil-resistance performance criterion result (=Typical value).  
 Products to be shipped will have around 2 years of oil resistance, but will vary depending on the product.

**e-jig (Mounting Sleeves) [Refer to Dimensions on page 34.]**

A Mounting Bracket is not provided with the Sensor. It must be ordered separately as required.

Appearance	Model	Applicable Sensors
	Y92E-J8S12	E2E NEXT M8 Shielded Sensors
	Y92E-J12S18	E2E NEXT M12 Shielded Sensors
	Y92E-J18S30	E2E NEXT M18 Shielded Sensors

**Note:** Not applicable for E2EQ NEXT Series (spatter-resistant) models.

# E2E/E2EQ NEXT Series

## Ratings and Specifications

### E2E NEXT Series (Triple distance model) DC 2-wire

Item	Size Shielded Model	M8		M12		M18		M30	
		Shielded	Unshielded	Shielded	Unshielded	Shielded	Unshielded	Shielded	Unshielded
		E2E-X3D□	E2E-X6MD□	E2E-X7D□	E2E-X10MD□	E2E-X11D□	E2E-X20MD□	E2E-X20D□	E2E-X40MD□
<b>Sensing distance</b>		3 mm ±10%	6 mm ±10%	7 mm ±10%	10 mm ±10%	11 mm ±10%	20 mm ±10%	20 mm ±10%	40 mm ±10%
<b>Setting distance *1</b>		0 to 2.4 mm	0 to 4.8 mm	0 to 5.6 mm	0 to 8 mm	0 to 8.8 mm	0 to 16 mm	0 to 16 mm	0 to 32 mm
<b>Differential travel</b>		15% max. of sensing distance							
<b>Detectable object</b>		Ferrous metal (The sensing distance decreases with non-ferrous metal. Refer to <i>Engineering Data</i> on page 23.)							
<b>Standard sensing object</b>		Iron, 9 × 9 × 1 mm	Iron, 18 × 18 × 1 mm	Iron, 21 × 21 × 1 mm	Iron, 30 × 30 × 1 mm	Iron, 33 × 33 × 1 mm	Iron, 60 × 60 × 1 mm	Iron, 60 × 60 × 1 mm	Iron, 120 × 120 × 1 mm
<b>Response frequency *2</b>		350 Hz	250 Hz	350 Hz	200 Hz	250 Hz	200 Hz	200 Hz	50 Hz
<b>Power supply voltage</b>		10 to 30 VDC, (including 10% ripple (p-p))							
<b>Leakage current</b>		0.8 mA max.							
<b>Control output</b>	<b>Load current</b>	3 to 100 mA							
	<b>Residual voltage</b>	Polarity: 3 V max. (Load current: 100 mA, Cable length: 2 m) No polarity: 5 V max. (Load current: 100 mA, Cable length: 2 m)							
<b>Indicator</b>		D1 Models: Operation indicator (orange), Setting indicator (green) D2 Models: Operation indicator (orange)							
<b>Operation mode</b>		D1 Models: NO D2 Models: NC Refer to the timing charts under <i>I/O Circuit Diagrams</i> on page 26 for details.							
<b>Protection circuits</b>		Surge suppressor, Load short-circuit protection							
<b>Ambient temperature range</b>		Operating: -25 to 70°C, Storage: -40 to 85°C (with no icing or condensation)							
<b>Ambient humidity range</b>		Operating and Storage: 35% to 95% (with no condensation)							
<b>Temperature influence</b>		±10% max. of sensing distance at 23°C in the temperature range of -25 to 70°C		±20% max. of sensing distance at 23°C in the temperature range of -25 to 70°C		±10% max. of sensing distance at 23°C in the temperature range of -25 to 70°C		±20% max. of sensing distance at 23°C in the temperature range of -25 to 70°C	
<b>Voltage influence</b>		±1% max. of sensing distance at rated voltage in the rated voltage ±15% range							
<b>Insulation resistance</b>		50 MΩ min. (at 500 VDC) between current-carrying parts and case							
<b>Dielectric strength</b>		1,000 VAC, 50/60 Hz for 1 minute between current-carrying parts and case							
<b>Vibration resistance (destruction)</b>		10 to 55 Hz, 1.5-mm double amplitude for 2 hours each in X, Y, and Z directions							
<b>Shock resistance (destruction)</b>		500 m/s <sup>2</sup> 10 times each in X, Y, and Z directions		1,000 m/s <sup>2</sup> 10 times each in X, Y, and Z directions					
<b>Degree of protection</b>		Pre-wired Models/Pre-wired Connector Models: IP67 (IEC 60529), IP67G *3 (JIS C 0920 Annex 1) Passed OMRON's Oil-resistant Component Evaluation Standards *4 (Cutting oil type: specified in JIS K 2241:2000, Temperature: 35 °C max.) and ISO 20653 (old standard: DIN 40050 PART9) IP69K							
<b>Connecting method</b>		Pre-wired Models (Standard cable length: 2 m) and Pre-wired Connector Models (Standard cable length: 0.3 m)							
<b>Weight (packed state)</b>	<b>Pre-wired Models</b>	Approx. 60 g		Approx. 70 g		Approx. 130 g		Approx. 150 g	
	<b>Pre-wired Connector Models</b>	Approx. 30 g		Approx. 40 g		Approx. 70 g		Approx. 90 g	
<b>Materials</b>	<b>Case</b>	Nickel-plated brass	Stainless steel (SUS303)	Nickel-plated brass					
	<b>Sensing surface</b>	Polybutylene terephthalate (PBT)							
	<b>Clamping nuts</b>	Nickel-plated brass							
	<b>Toothed washer</b>	Zinc-plated iron							
<b>Cable</b>	Vinyl chloride (PVC)								
<b>Accessories</b>		Instruction manual, Clamping nuts, Toothed washer							

\*1. Use the Sensor within the range in which the setting indicator (green LED) is ON (except D2 Models).

\*2. The response frequency is an average value. Measurement conditions are as follows: standard sensing object, a distance of twice the standard sensing object, and a set distance of half the sensing distance.

\*3. The IP67G is the degree of protection which is defined according to the JIS (Japanese Industrial Standards). The IP67 indicates the same level of protection as defined by the IEC, and the G indicates that a device has resistance to oil.

\*4. The Oil-resistant Component Evaluation Standards are OMRON's own durability evaluation standards. 2-year oil resistance indicates the median value of the product design and the oil-resistance performance criterion result (=Typical value). The Pre-wired Connector Model verifies 2 years of oil resistance when mating with Round Oil-resistant Connectors XS5 NEXT series correctly. The degree of protection is not satisfied with the part where cable wires are uncovered for the Pre-wired Models.

E2EQ NEXT Series (Spatter-resistant Triple distance model)  
DC 2-wire

Item	Size Shielded Model	M8	M12	M18	M30
		Shielded			
		E2EQ-X3D□	E2EQ-X7D□	E2EQ-X11D□	E2EQ-X20D□
Sensing distance		3 mm ±10%	7 mm ±10%	11 mm ±10%	20 mm ±10%
Setting distance *1		0 to 2.4 mm	0 to 5.6 mm	0 to 8.8 mm	0 to 16 mm
Differential travel		15% max. of sensing distance			
Detectable object		Ferrous metal (The sensing distance decreases with non-ferrous metal. Refer to <i>Engineering Data</i> on page 23.)			
Standard sensing object		Iron, 9 × 9 × 1 mm	Iron, 21 × 21 × 1 mm	Iron, 33 × 33 × 1 mm	Iron, 60 × 60 × 1 mm
Response frequency *2		250 Hz	250 Hz	250 Hz	200 Hz
Power supply voltage		10 to 30 VDC, (including 10% ripple (p-p))			
Leakage current		0.8 mA max.			
Control output	Load current	3 to 100 mA			
	Residual voltage	Polarity: 3 V max. (Load current: 100 mA, Cable length: 2 m) No polarity: 5 V max. (Load current: 100 mA, Cable length: 2 m)			
Indicator		D1 Models: Operation indicator (orange), Setting indicator (green) D2 Models: Operation indicator (orange)			
Operation mode		D1 Models: NO    Refer to the timing charts under <i>I/O Circuit Diagrams</i> on page 26 for details. D2 Models: NC			
Protection circuits		Surge suppressor, Load short-circuit protection			
Ambient temperature range		Operating: -25 to 70°C, Storage: -40 to 85°C (with no icing or condensation)			
Ambient humidity range		Operating and Storage: 35% to 95% (with no condensation)			
Temperature influence		±10% max. of sensing distance at 23°C in the temperature range of -25 to 70°C		±20% max. of sensing distance at 23°C in the temperature range of -25 to 70°C	
Voltage influence		±1% max. of sensing distance at rated voltage in the rated voltage ±15% range			
Insulation resistance		50 MΩ min. (at 500 VDC) between current-carrying parts and case			
Dielectric strength		1,000 VAC, 50/60 Hz for 1 minute between current-carrying parts and case			
Vibration resistance (destruction)		10 to 55 Hz, 1.5-mm double amplitude for 2 hours each in X, Y, and Z directions			
Shock resistance (destruction)		500 m/s <sup>2</sup> 10 times each in X, Y, and Z directions	1,000 m/s <sup>2</sup> 10 times each in X, Y, and Z directions		
Degree of protection		Pre-wired Models/Pre-wired Connector Models: IP67 (IEC 60529) and IP67G *3 (JIS C 0920 Annex 1)			
Connecting method		Pre-wired Models (Standard cable length: 2 m) and Pre-wired Connector Models (Standard cable length: 0.3 m)			
Weight (packed state)	Pre-wired Models	Approx. 60 g	Approx. 70 g	Approx. 150 g	Approx. 210 g
	Pre-wired Connector Models	Approx. 30 g	Approx. 40 g	Approx. 90 g	Approx. 140 g
Materials	Case	Fluororesin coating (Base material: brass)			
	Sensing surface	Fluororesin			
	Clamping nuts	Fluororesin coating (Base material: brass)			
	Toothed washer	Zinc-plated iron			
	Cable	Vinyl chloride (PVC)			
Accessories		Instruction manual, Clamping nuts, Toothed washer			

\*1. Use the Sensor within the range in which the setting indicator (green LED) is ON (except D2 Models).

\*2. The response frequency is an average value. Measurement conditions are as follows: standard sensing object, a distance of twice the standard sensing object, and a set distance of half the sensing distance.

\*3. The IP67G is the degree of protection which is defined according to the JIS (Japanese Industrial Standards).

The IP67 indicates the same level of protection as defined by the IEC, and the G indicates that a device has resistance to oil.



# E2E/E2EQ NEXT Series

## E2E NEXT Series (Single distance model) DC 2-wire

Item	Size Shielded Model	M8	M12	M18
		Shielded		
		E2E-X1R5D□	E2E-X2R5D□	E2E-X5D□
Sensing distance		1.5 mm ±10%	2.5 mm ±10%	5 mm ±10%
Setting distance *1		0 to 1.2 mm	0 to 2 mm	0 to 4 mm
Differential travel		10% max. of sensing distance		
Detectable object		Ferrous metal (The sensing distance decreases with non-ferrous metal. Refer to <i>Engineering Data</i> on page 23.)		
Standard sensing object		Iron, 10 × 10 × 1 mm	Iron, 12 × 12 × 1 mm	Iron, 18 × 18 × 1 mm
Response frequency *2		250 Hz	250 Hz	250 Hz
Power supply voltage		10 to 30 VDC, (including 10% ripple (p-p))		
Leakage current		0.8 mA max.		
Control output	Load current	3 to 100 mA		
	Residual voltage	Polarity: 3 V max. (Load current: 100 mA, Cable length: 2 m) No polarity: 5 V max. (Load current: 100 mA, Cable length: 2 m)		
Indicator		D1 Models: Operation indicator (orange), Setting indicator (green) D2 Models: Operation indicator (orange)		
Operation mode		D1 Models: NO      Refer to the timing charts under <i>I/O Circuit Diagrams</i> on page 26 for details. D2 Models: NC		
Protection circuits		Surge suppressor, Load short-circuit protection		
Ambient temperature range		Operating: -25 to 70°C, Storage: -40 to 85°C (with no icing or condensation)		
Ambient humidity range		Operating and Storage: 35% to 95% (with no condensation)		
Temperature influence		±10% max. of sensing distance at 23°C in the temperature range of -25 to 70°C		
Voltage influence		±1% max. of sensing distance at rated voltage in the rated voltage ±15% range		
Insulation resistance		50 MΩ min. (at 500 VDC) between current-carrying parts and case		
Dielectric strength		1,000 VAC, 50/60 Hz for 1 minute between current-carrying parts and case		
Vibration resistance (destruction)		10 to 55 Hz, 1.5-mm double amplitude for 2 hours each in X, Y, and Z directions		
Shock resistance (destruction)		500 m/s <sup>2</sup> 10 times each in X, Y, and Z directions	1,000 m/s <sup>2</sup> 10 times each in X, Y, and Z directions	
Degree of protection		Pre-wired Models/Pre-wired Connector Models: IP67 (IEC 60529), IP67G *3 (JIS C 0920 Annex 1) Passed OMRON's Oil-resistant Component Evaluation Standards *4 (Cutting oil type: specified in JIS K 2241:2000, Temperature: 35°C max.) and ISO 20653 (old standard: DIN 40050 PART9) IP69K		
Connecting method		Pre-wired Models (Standard cable length: 2 m) and Pre-wired Connector Models (Standard cable length: 0.3 m)		
Weight (packed state)	Pre-wired Models	Approx. 60 g	Approx. 70 g	Approx. 130 g
	Pre-wired Connector Models	Approx. 30 g	Approx. 40 g	Approx. 70 g
Materials	Case	Stainless steel (SUS303)	Nickel-plated brass	
	Sensing surface	Polybutylene terephthalate (PBT)		
	Clamping nuts	Nickel-plated brass		
	Toothed washer	Zinc-plated iron		
	Cable	Vinyl chloride (PVC)		
Accessories		Instruction manual, Clamping nuts, Toothed washer		

\*1. Use the Sensor within the range in which the setting indicator (green LED) is ON (except D2 Models).

\*2. The response frequency is an average value. Measurement conditions are as follows: standard sensing object, a distance of twice the standard.

\*3. The IP67G is the degree of protection which is defined according to the JIS (Japanese Industrial Standards).

The IP67 indicates the same level of protection as defined by the IEC, and the G indicates that a device has resistance to oil.

\*4. The Oil-resistant Component Evaluation Standards are OMRON's own durability evaluation standards.

2-year oil resistance indicates the median value of the product design and the oil-resistance performance criterion result (=Typical value).

The Pre-wired Connector Model verifies 2 years of oil resistance when mating with Round Oil-resistant Connectors XS5 NEXT series correctly.

The degree of protection is not satisfied with the part where cable wires are uncovered for the Pre-wired Models.



# Engineering Data (Reference Value)

## Sensing Area

Triple distance model, Spatter-resistant Triple distance model

**Shielded Models**

**E2E(Q)-X□D□**

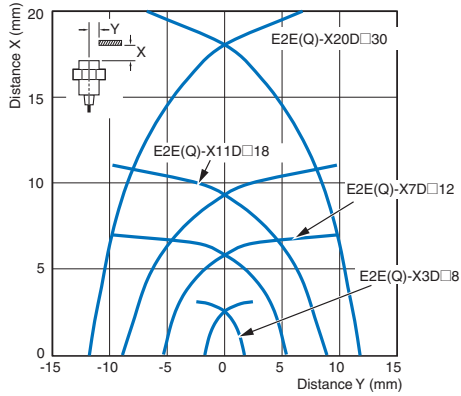

**Unshielded Models**

**E2E-X□MD□**

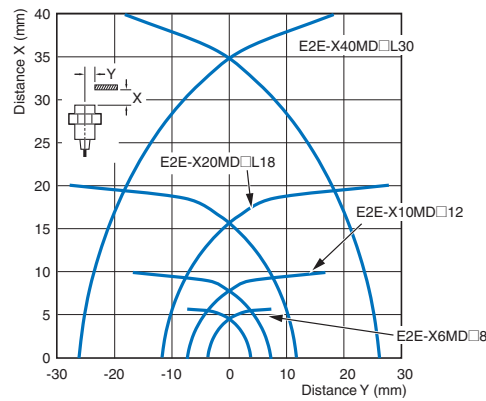

Single distance model

**Shielded Models**

**E2E-X1R5D□/-X2R5D□/-X5D□**

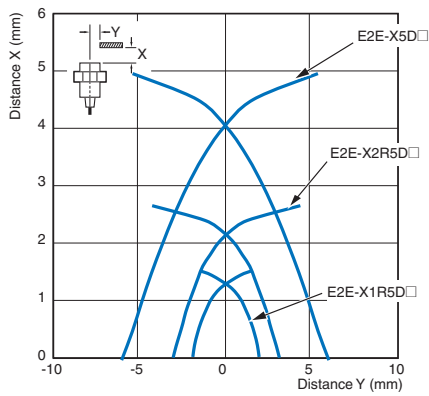

E2E/E2EQ NEXT Series DC 2-wire

E2E/E2EQ NEXT Series DC 3-wire

XSS5 NEXT Series

XSS

XSS3

## Influence of Sensing Object Size and Materials

Triple distance model, Spatter-resistant Triple distance model

### Shielded Models

#### E2E(Q)-X3D□8

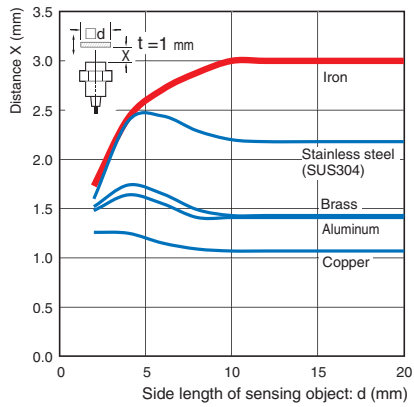

#### E2E(Q)-X7D□12

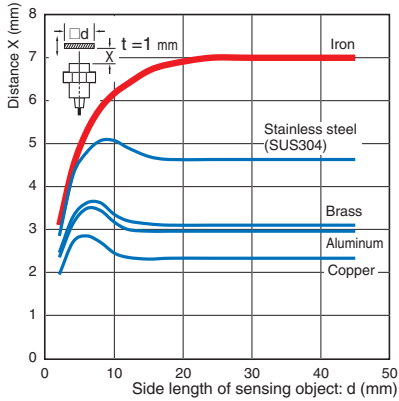

#### E2E(Q)-X11D□18

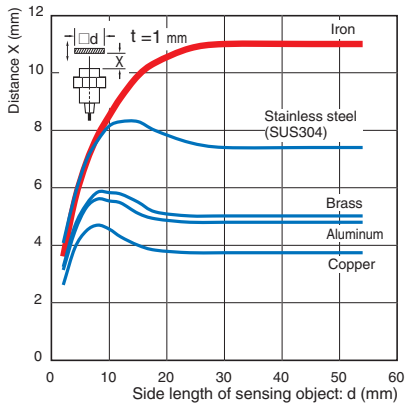

#### E2E(Q)-X20D□30

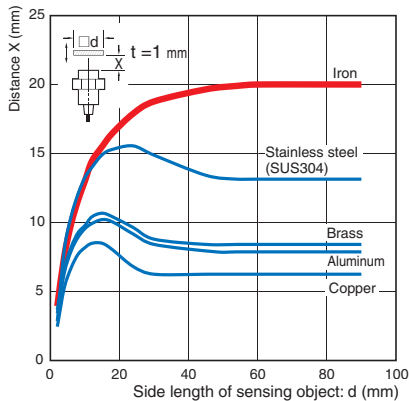

### Unshielded Models

#### E2E-X6MD□8

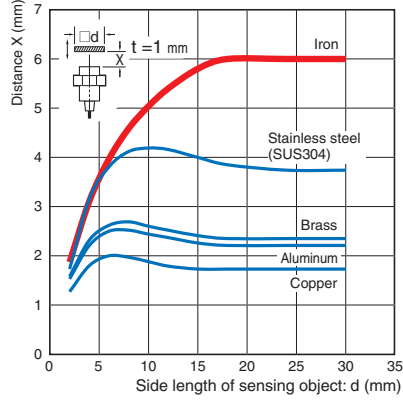

#### E2E-X10MD□12

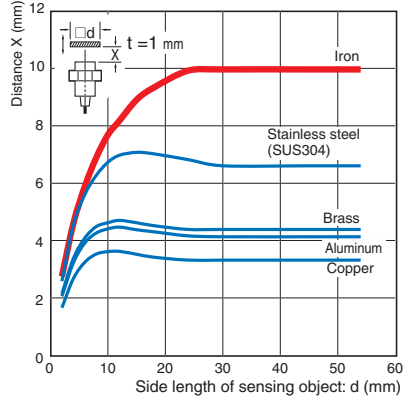

#### E2E-X20MD□L18

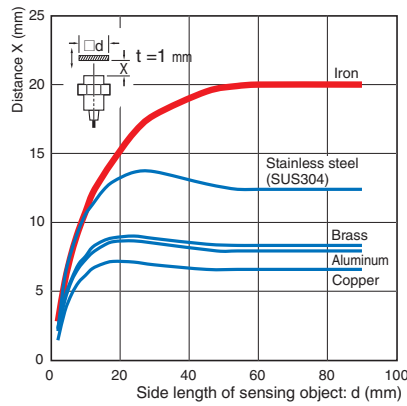

#### E2E-X40MD□L30

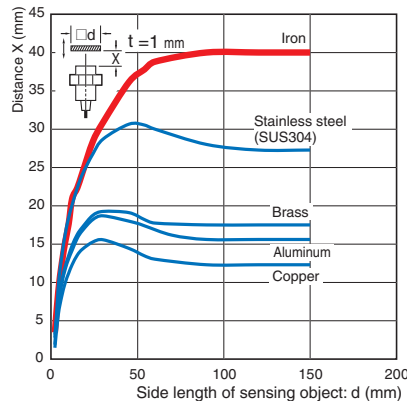

### Single distance model

### Shielded Models

#### E2E-X1R5D□

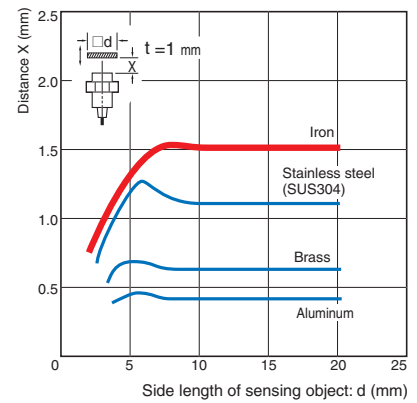

#### E2E-X2R5D□

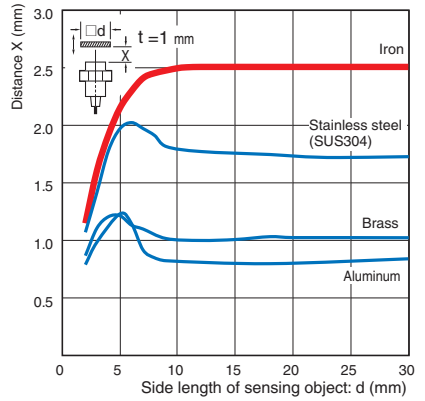

#### E2E-X5D□

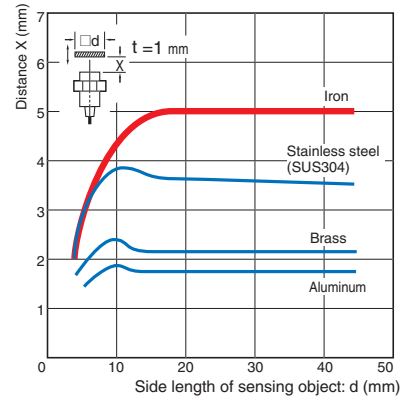

**Leakage Current**

Triple distance model, Spatter-resistant Triple distance model, Single distance model

E2E-X□(M)D□(-T)/E2EQ-X□D□(-T)

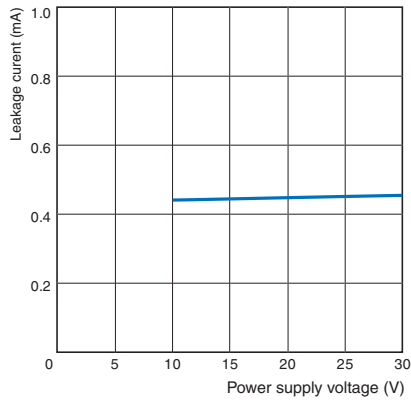

**Residual Output Voltage**

Triple distance model, Spatter-resistant Triple distance model, Single distance model

E2E-X□(M)D□(-T)/E2EQ-X□D□(-T)

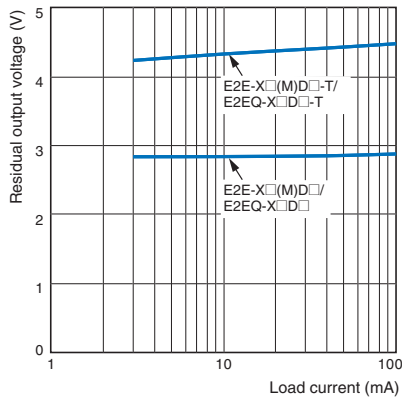

# E2E/E2EQ NEXT Series

## I/O Circuit Diagrams

### DC 2-Wire Models

Operation mode	Model	Timing Chart	Output circuit
NO	E2E(Q)-X□D1□		<p>Connector Pin Arrangement: </p> <p>Note: Pins 2 and 3 are not used.</p>
	E2E(Q)-X□D1□-T		<p>Connector Pin Arrangement: </p> <p>Note: Pins 1 and 2 are not used.</p> <p>Note1. The load can be connected to either the +V or 0 V side. 2. The E2E□-X□D1□(-M1TGJ)-T has no polarity. There is no need to be concerned about the polarity of brown and blue wires, or pins 3 and 4.</p>
NC	E2E(Q)-X□D2□		<p>Connector Pin Arrangement: </p> <p>Note: Pins 3 and 4 are not used.</p>
	E2E(Q)-X□D2□-T		<p>Connector Pin Arrangement: </p> <p>Note: Pins 3 and 4 are not used.</p> <p>Note1. The load can be connected to either the +V or 0 V side. 2. The E2E□-X□D1□(-M1TGJ)-T has no polarity. There is no need to be concerned about the polarity of brown and blue wires, or pins 1 and 2.</p>

# Connections to Sensor I/O Connectors

Proximity Sensor				Sensor I/O Connector model number	Connections
Type	Polarity	Operation mode	Model		
DC 2-wire (Smartclick Connector)	Yes	NO	E2E-X□D1□-M1TGJ E2EQ-X□D1□-M1TGJ	XS5F-D421-□80-X□ XS5F-D42□-□80-F XS5W-D421-□81-X□ XS5W-D42□-□81-F  <b>Note:</b> For details of the connector, refer to <i>XS5 NEXT Series</i> on page 87. <i>XS5 Series</i> on page 94.	
	No	NC	E2E-X□D2□-M1TGJ E2EQ-X□D2□-M1TGJ		
	Yes	NO	E2E-X□D1□-M1TGJ-T E2EQ-X□D1□-M1TGJ-T		
	No	NC	E2E-X□D2□-M1TGJ-T E2EQ-X□D2□-M1TGJ-T		

**Note:** Different from Proximity Sensor wire colors.

\* If the XS5W Series Connector which has a socket and plug on the cable ends is connected to the Sensor, this part will be a plug.

E2E/E2EQ NEXT Series DC 2-wire

E2E/E2EQ NEXT Series DC 3-wire

XS5 NEXT Series

XS5

XS3



## Safety Precautions



Be sure to read the precautions for all models in the website at: <http://www.ia.omron.com/>.

### Warning Indications

<b>⚠ WARNING</b>	<b>Warning level</b> Indicates a potentially hazardous situation which, if not avoided, will result in minor or moderate injury, or may result in serious injury or death. Additionally there may be significant property damage.
<b>Precautions for Safe Use</b>	Supplementary comments on what to do or avoid doing, to use the product safely.
<b>Precautions for Correct Use</b>	Supplementary comments on what to do or avoid doing, to prevent failure to operate, malfunction or undesirable effect on product performance.

### Meaning of Product Safety Symbols

	<b>General prohibition</b> Indicates the instructions of unspecified prohibited action.
	<b>Caution, explosion</b> Indicates the possibility of explosion under specific conditions.

<b>⚠ WARNING</b>
<p><b>This product is not designed or rated for ensuring safety of persons either directly or indirectly. Do not use it for such purposes.</b></p> <div style="text-align: right;"></div>
<p><b>Risk of explosion.</b></p> <p><b>Do not connect sensor to AC power supply.</b></p> <div style="text-align: right;"></div>

### Precautions for Safe Use

The following precautions must be observed to ensure safe operation.

1. Do not use the product in an environment where flammable or explosive gas is present.
2. Do not attempt to disassemble, repair, or modify the product.
3. Do not use a voltage that exceeds the rated operating voltage range. Applying a voltage that is higher than the operating voltage range may result in damage or burnout.
4. Be sure that the power supply polarity and other wiring is correct. Incorrect wiring may cause explosion or burnout.
5. If the power supply is connected directly without a load, the internal elements may explode or burn. Be sure to insert a load when connecting the power supply.
6. Dispose of this product as industrial waste.

### Precautions for Correct Use

Do not use this product under ambient conditions that exceed the ratings.

#### ● Operating Environment

1. Do not install the product in the following locations. Doing so may result in product failure or malfunction.
  - (1) Outdoor locations directly subject to sunlight, rain, snow, water droplets, or oil.
  - (2) Locations subject to atmospheres with chemical vapors, in particular solvents and acids.
  - (3) Locations subject to corrosive gases.
2. The Sensor may malfunction if used near ultrasonic cleaning equipment, high-frequency equipment, transceivers, cellular phones, inverters, or other devices that generate a high-frequency electric field. Please refer to the Precautions for Correct Use on the OMRON website ([www.ia.omron.com](http://www.ia.omron.com)) for typical measures.
3. Laying the Proximity Sensor wiring in the same conduit or duct as high-voltage wires or power lines may result in incorrect operation and damage due to induction. Wire the Sensor using a separate conduit or independent conduit.
4. Never use thinner or other solvents. Otherwise, the Sensor surface may be dissolved.
5. The following conditions shall be observed if you use the product under an environment using cutting oil that may affect product's life and/or performance.
  - Usage under the cutting oil condition designated by the specification
  - Usage under the cutting oil dilution ratio recommended by its manufacturer
  - Usage in oil or water is prohibited

Impact on the product life may differ depending on the oil you use. Before using the cutting oil, make sure that it should not cause deterioration or degradation of sealing components.

● Design

**Influence of Surrounding Metal**

When mounting the Proximity Sensor using a nut, only use the provided nut. And ensure that the minimum distances given in the following table are maintained.

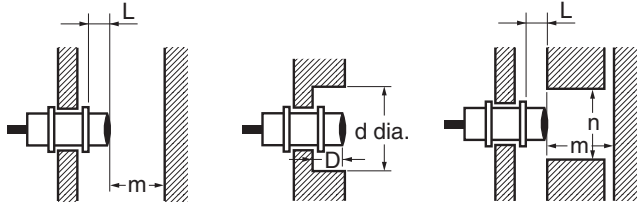

(Unit: mm)

Type	Item	M8	M12	M18	M30
Triple distance model/ Spatter-resistant Triple distance model E2E(Q)-X□D□(-T) *1	L	0	0	0	0
	d	20	20	50	70
	D	2	4	4	8
	m	9	18	33	60
	n	18	20	54	90
Triple distance model E2E-X□MD□(-T) *2	L	10	16	31	50 *3
	d	30	50	90	170
	D	13	20	35	55
	m	18	30	60	120
	n	30	50	80	140
Single distance model E2E-X□R5D□(-T) E2E-X5D□(-T) *2	L	0	0	0	
	d	8	12	18	
	D	0	0	0	---
	m	4.5	8	20	
	n	12	18	27	

**Note:** Nuts that are supplied along with each Sensor (\*1, \*2) are different. Refer to *Dimensions* for details on shapes.

\*3. If you use the M30 Triple distance model of Unshielded Model, the panel thickness (t) is 4 mm or less.

When the Proximity Sensor is mounted in metal, ensure that the minimum distances given in the following table are maintained.

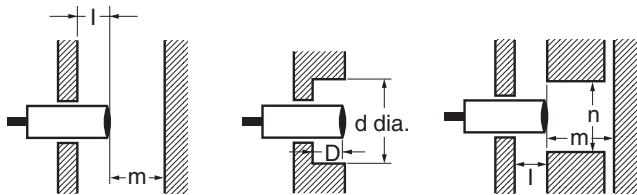

(Unit: mm)

Type	Item	M8	M12	M18	M30
Triple distance model/ Spatter-resistant Triple distance model E2E(Q)-X□D□(-T)	l	2	4	4	8
	d	20	20	50	70
	D	2	4	4	8
	m	9	18	33	60
	n	18	20	54	90
Triple distance model E2E-X□MD□(-T)	l	13	20	35	55
	d	30	50	90	170
	D	13	20	35	55
	m	18	30	60	120
	n	30	50	80	140
Single distance model E2E-X□R5D□(-T) E2E-X5D□(-T)	l	0	0	0	
	d	8	12	18	
	D	0	0	0	---
	m	4.5	8	20	
	n	12	18	27	

● Mutual Interference

When the Proximity Sensor is embedded in metal, ensure that the minimum distances given in the following table are maintained.

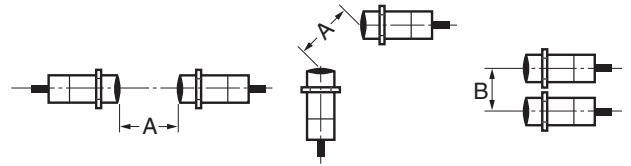

(Unit: mm)

Type	Item	M8	M12	M18	M30
Triple distance model/ Spatter-resistant Triple distance model E2E(Q)-X□D□(-T)	Shielded A	25	40	70	140
	Shielded B	20	30	45	70
Triple distance model E2E-X□MD□(-T)	Unshielded A	80	120	200	380
	Unshielded B	60	100	120	280
Single distance model E2E-X□R5D□(-T) E2E-X5D□(-T)	Shielded A	20	30	50	---
	Shielded B	15	20	35	---

● Mounting

**Tightening Force**

Do not tighten the nut with excessive force. A washer must be used with the nut.

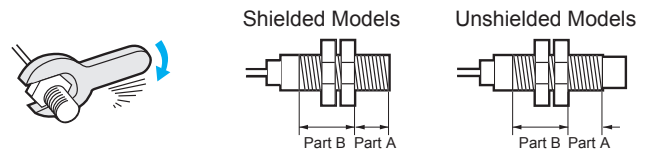

**Note:** 1. The allowable tightening strength depends on the distance from the edge of the head, as shown in the following table. (A is the distance from the edge of the head. B includes the nut on the head side. If the edge of the nut is in part A, the tightening torque for part A applies instead.)  
2. The following strengths assume washers are being used.

**Triple distance model**

Model	Part A		Part B
	Dimension (mm)	Torque	Torque
M8	Shielded 9	4 N·m	10 N·m
	Unshielded 3		
M12	Shielded 16	6 N·m	15 N·m
	Unshielded 9		
M18	Shielded 16	15 N·m	60 N·m
	Unshielded 3		
M30	Shielded 23	40 N·m	80 N·m
	Unshielded 8		

**Spatter-resistant Triple distance model**

Model	Part A		Part B
	Dimension (mm)	Torque	Torque
M8	9	4 N·m	10 N·m
M12	16	6 N·m	15 N·m
M18	16	15 N·m	30 N·m
M30	23	40 N·m	80 N·m

**Single distance model**

Model	Part A		Part B
	Dimension (mm)	Torque	Torque
M8	9	9 N·m	12 N·m
M12	---	30 N·m	
M18	---	70 N·m	



# E2E/E2EQ NEXT Series

## Dimensions

(Unit: mm)  
Tolerance class IT16 applies to dimensions in this data sheet unless otherwise specified.

### Sensors

### E2E NEXT Series (Triple distance model)

### DC 2-wire

#### Pre-wired Models Shielded



#### E2E-X3D□8

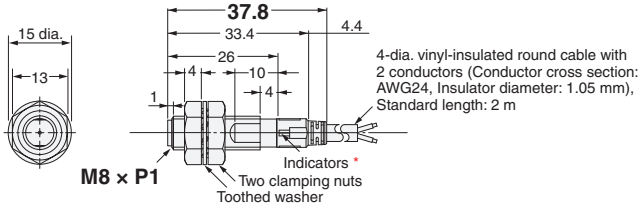

\* D1 Models: Operation indicator (Orange), Setting indicator (Green)  
D2 Models: Operation indicator (Orange)

#### Pre-wired Models Unshielded



#### E2E-X6MD□8

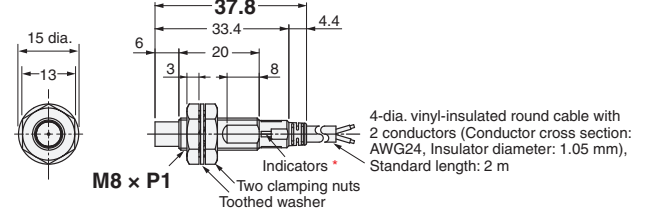

\* D1 Models: Operation indicator (Orange), Setting indicator (Green)  
D2 Models: Operation indicator (Orange)

#### E2E-X7D□12

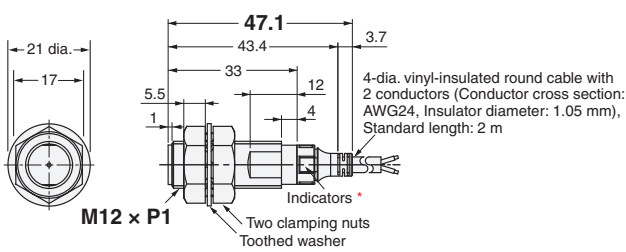

\* D1 Models: Operation indicator (Orange), Setting indicator (Green)  
D2 Models: Operation indicator (Orange)

#### E2E-X10MD□12

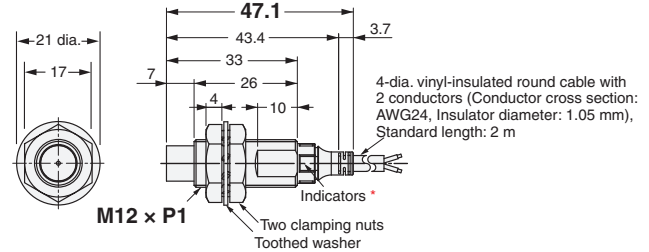

\* D1 Models: Operation indicator (Orange), Setting indicator (Green)  
D2 Models: Operation indicator (Orange)

#### E2E-X11D□18

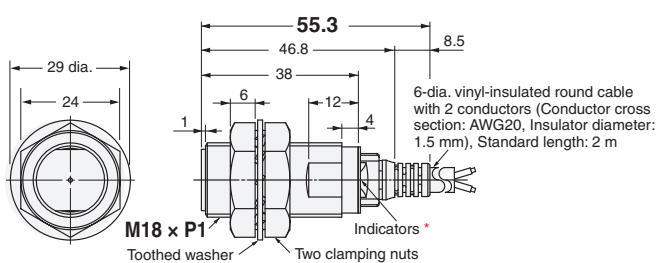

\* D1 Models: Operation indicator (Orange), Setting indicator (Green)  
D2 Models: Operation indicator (Orange)

#### E2E-X20MD□18

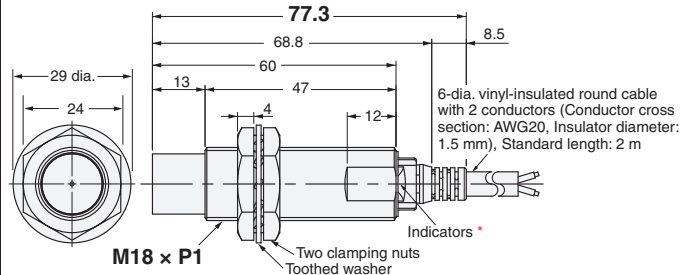

\* D1 Models: Operation indicator (Orange), Setting indicator (Green)  
D2 Models: Operation indicator (Orange)

#### E2E-X20D□30

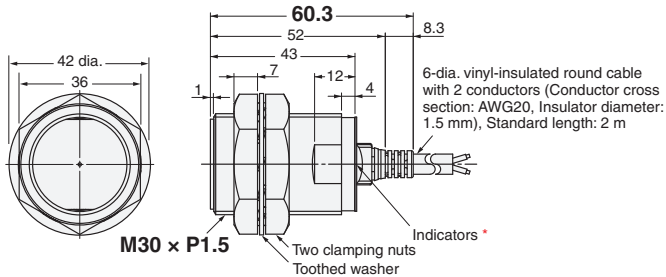

\* D1 Models: Operation indicator (Orange), Setting indicator (Green)  
D2 Models: Operation indicator (Orange)

#### E2E-X40MD□L30

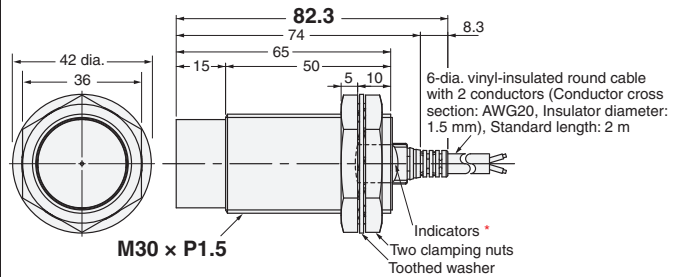

\* D1 Models: Operation indicator (Orange), Setting indicator (Green)  
D2 Models: Operation indicator (Orange)

#### Mounting Hole Dimensions

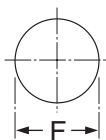

Dimensions	F (mm)
M8	8.5 dia. $+0.5$ <sub>0</sub>
M12	12.5 dia. $+0.5$ <sub>0</sub>
M18	18.5 dia. $+0.5$ <sub>0</sub>
M30	30.5 dia. $+0.5$ <sub>0</sub>

#### Angle R of the Bending Wire

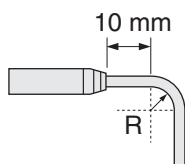

Dimensions	R (mm)
M8	12
M12	
M18	18
M30	

#### Wire pullout position

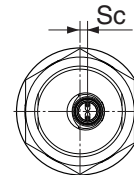

Dimensions	Sc (mm)
M8	- (0)
M12	
M18	2.5
M30	

## Pre-wired Connector Models Shielded



### E2E-X3D□8-M1TGJ

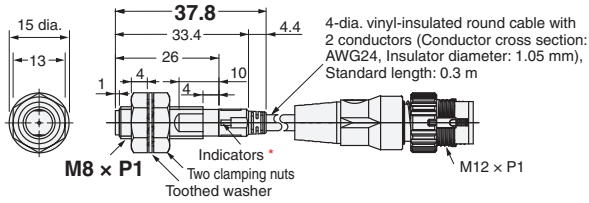

\* D1 Models: Operation indicator (Orange), Setting indicator (Green)  
D2 Models: Operation indicator (Orange)

## Pre-wired Connector Models Unshielded



### E2E-X6MD□8-M1TGJ

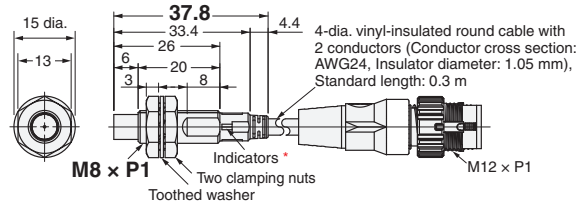

\* D1 Models: Operation indicator (Orange), Setting indicator (Green)  
D2 Models: Operation indicator (Orange)

### E2E-X7D□12-M1TGJ

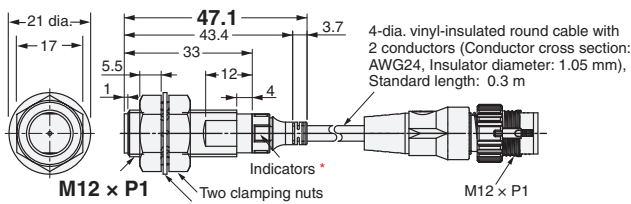

\* D1 Models: Operation indicator (Orange), Setting indicator (Green)  
D2 Models: Operation indicator (Orange)

### E2E-X10MD□12-M1TGJ

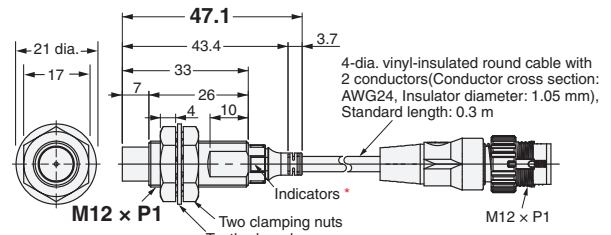

\* D1 Models: Operation indicator (Orange), Setting indicator (Green)  
D2 Models: Operation indicator (Orange)

### E2E-X11D□18-M1TGJ

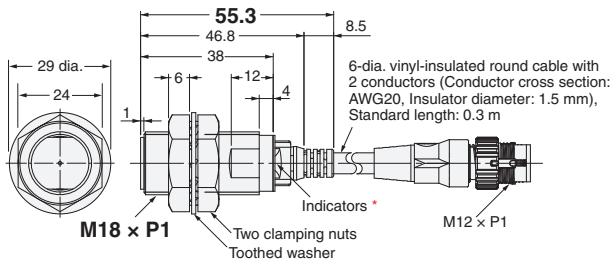

\* D1 Models: Operation indicator (Orange), Setting indicator (Green)  
D2 Models: Operation indicator (Orange)

### E2E-X20MD□18-M1TGJ

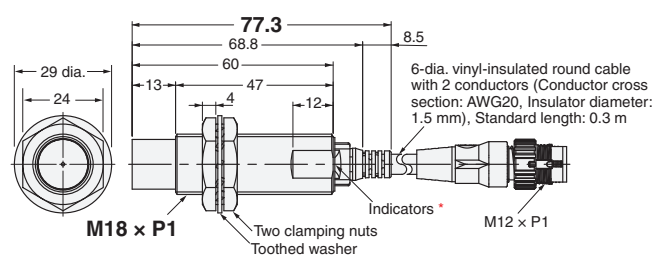

\* D1 Models: Operation indicator (Orange), Setting indicator (Green)  
D2 Models: Operation indicator (Orange)

### E2E-X20D□30-M1TGJ

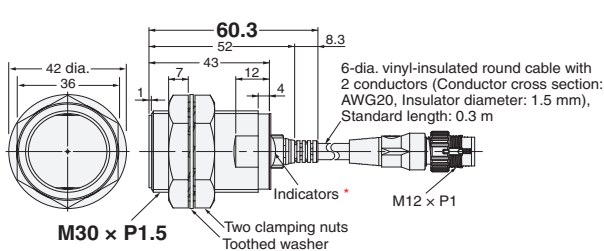

\* D1 Models: Operation indicator (Orange), Setting indicator (Green)  
D2 Models: Operation indicator (Orange)

### E2E-X40MD□L30-M1TGJ

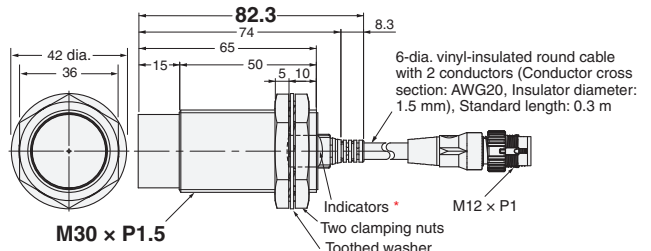

\* D1 Models: Operation indicator (Orange), Setting indicator (Green)  
D2 Models: Operation indicator (Orange)

## Mounting Hole Dimensions

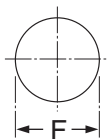

Dimensions	F (mm)
M8	8.5 dia. $^{+0.5}_0$
M12	12.5 dia. $^{+0.5}_0$
M18	18.5 dia. $^{+0.5}_0$
M30	30.5 dia. $^{+0.5}_0$

## Angle R of the Bending Wire

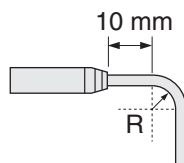

Dimensions	R (mm)
M8	10
M12	12
M18	18
M30	18

## Wire pullout position

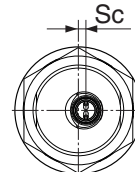

Dimensions	Sc (mm)
M8	- (0)
M12	- (0)
M18	- (0)
M30	2.5

# E2E/E2EQ NEXT Series

## Sensors

### E2EQ NEXT Series (Spatter-resistant Triple distance model)

#### DC 2-wire

##### Pre-wired Models Shielded



#### E2EQ-X3D□8

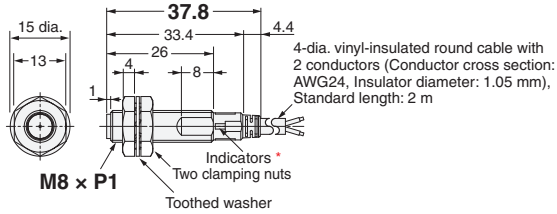

\* D1 Models: Operation indicator (Orange), Setting indicator (Green)  
D2 Models: Operation indicator (Orange)

#### E2EQ-X7D□12

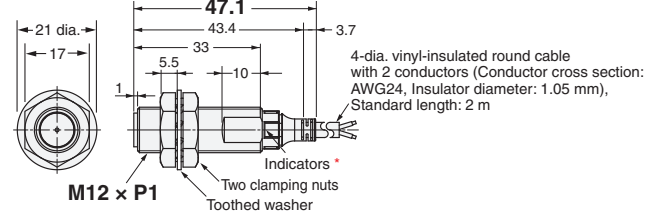

\* D1 Models: Operation indicator (Orange), Setting indicator (Green)  
D2 Models: Operation indicator (Orange)

#### E2EQ-X11D□18

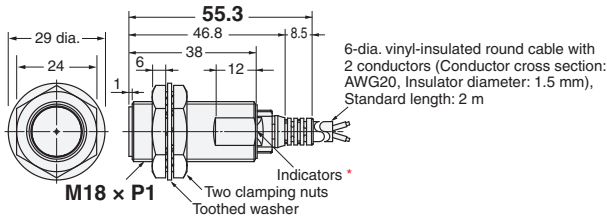

\* D1 Models: Operation indicator (Orange), Setting indicator (Green)  
D2 Models: Operation indicator (Orange)

#### E2EQ-X20D□30

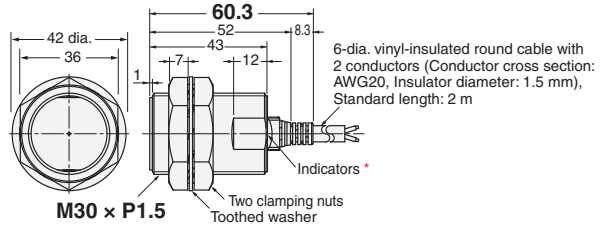

\* D1 Models: Operation indicator (Orange), Setting indicator (Green)  
D2 Models: Operation indicator (Orange)

##### Pre-wired Connector Models Shielded



#### E2EQ-X3D□8-M1TGJ

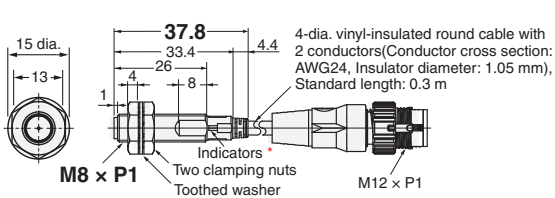

\* D1 Models: Operation indicator (Orange), Setting indicator (Green)  
D2 Models: Operation indicator (Orange)

#### E2EQ-X7D□12-M1TGJ

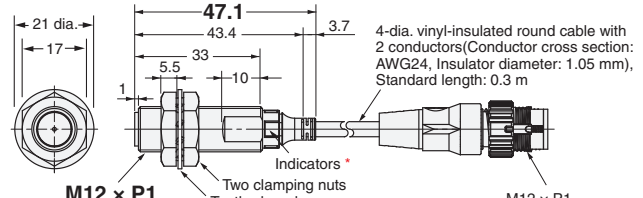

\* D1 Models: Operation indicator (Orange), Setting indicator (Green)  
D2 Models: Operation indicator (Orange)

#### E2EQ-X11D□18-M1TGJ

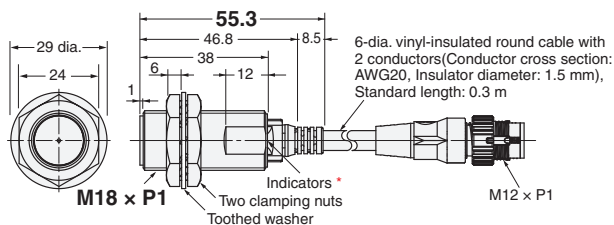

\* D1 Models: Operation indicator (Orange), Setting indicator (Green)  
D2 Models: Operation indicator (Orange)

#### E2EQ-X20D□30-M1TGJ

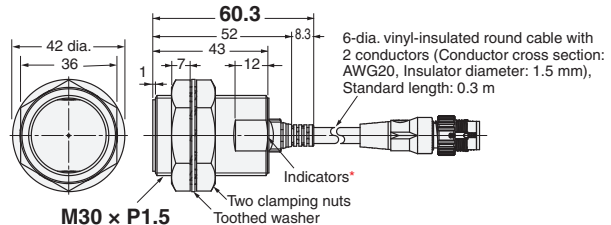

\* D1 Models: Operation indicator (Orange), Setting indicator (Green)  
D2 Models: Operation indicator (Orange)

#### Mounting Hole Dimensions

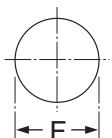

Dimensions	F (mm)
<b>M8</b>	8.5 dia. $+0.5_0$
<b>M12</b>	12.5 dia. $+0.5_0$
<b>M18</b>	18.5 dia. $+0.5_0$
<b>M30</b>	30.5 dia. $+0.5_0$

#### Angle R of the Bending Wire

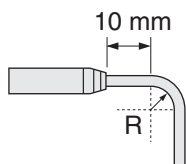

Dimensions	R (mm)
<b>M8</b>	12
<b>M12</b>	12
<b>M18</b>	18
<b>M30</b>	18

#### Wire pullout position

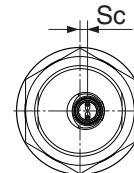

Dimensions	Sc (mm)
<b>M8</b>	- (0)
<b>M12</b>	- (0)
<b>M18</b>	2.5
<b>M30</b>	2.5

Sensors

E2E NEXT Series (Single distance model)

DC 2-wire

Pre-wired Models  
Shielded



E2E-X1R5D

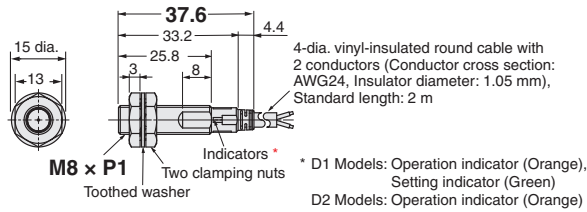

E2E-X2R5D

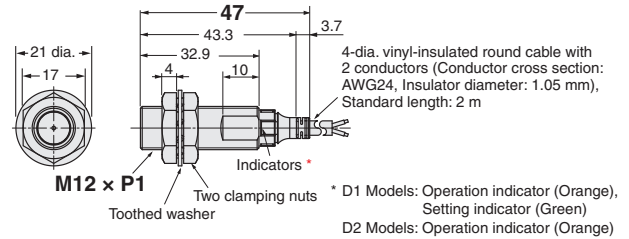

E2E-X5D

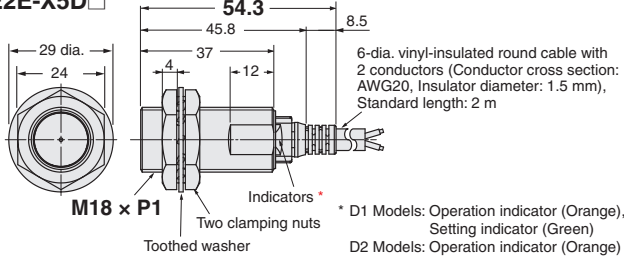

Pre-wired Connector Models  
Shielded



E2E-X1R5D-M1TGJ

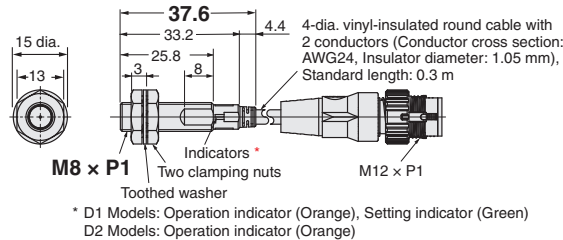

E2E-X2R5D-M1TGJ

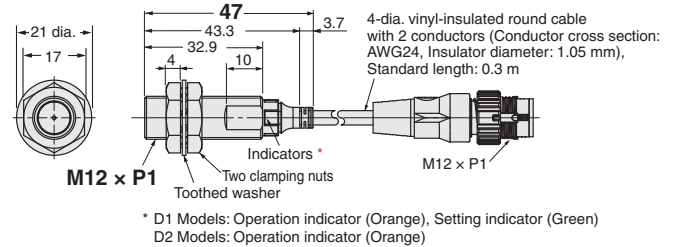

E2E-X5D-M1TGJ

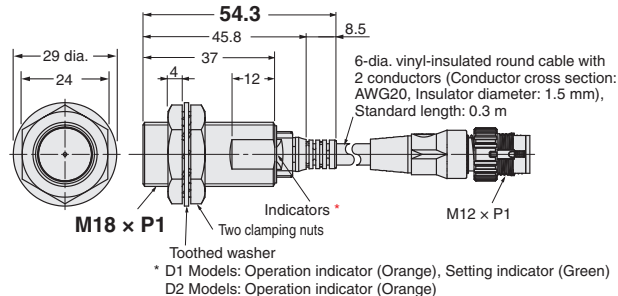

Mounting Hole Dimensions

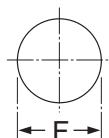

Dimensions	F (mm)
M8	8.5 dia. <sup>+0.5</sup> / <sub>0</sub>
M12	12.5 dia. <sup>+0.5</sup> / <sub>0</sub>
M18	18.5 dia. <sup>+0.5</sup> / <sub>0</sub>
M30	30.5 dia. <sup>+0.5</sup> / <sub>0</sub>

Angle R of the Bending Wire

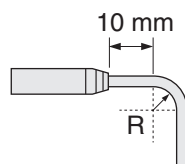

Dimensions	R (mm)
M8	12
M12	12
M18	18
M30	18

Wire pullout position

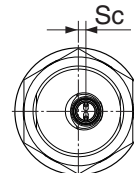

Dimensions	Sc (mm)
M8	- (0)
M12	- (0)
M18	2.5
M30	2.5

## Accessories (Sold Separately)

### e-jig (Mounting Sleeves)

#### Y92E-J8S12

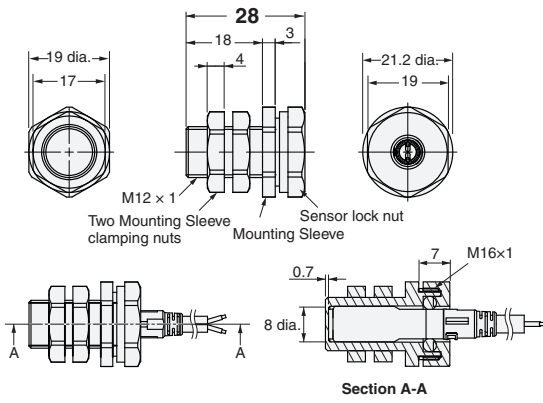

#### Y92E-J12S18

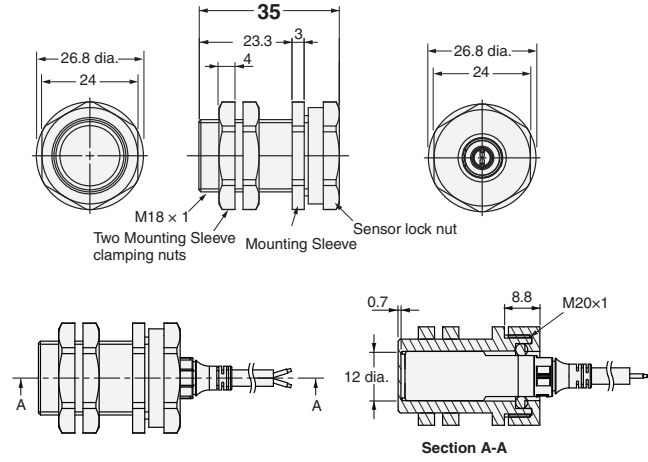

#### Y92E-J18S30

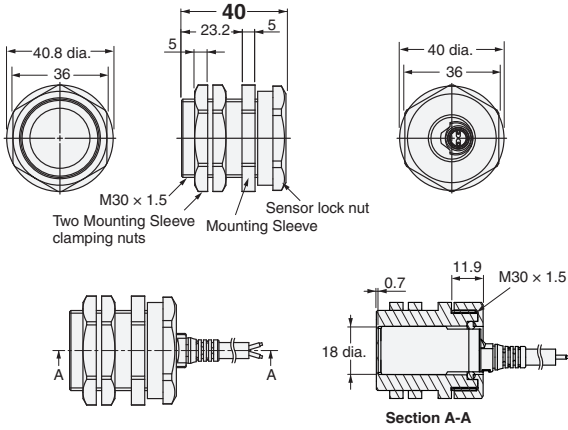

### Material

Mounting Sleeve	Polyetheretherketone (PEEK) / Polybutylene terephthalate (PBT)
Mounting Sleeve clamping nut	Polybutylene terephthalate (PBT)
Sensor lock nut	Polybutylene terephthalate (PBT)
Sensor lock O-ring	Material combining HNBR and fluororubber

### Tightening Force

Model	Torque	
	Mounting Sleeve clamping nut	Sensor lock nut
Y92E-J8S12	0.6 N·m	0.6 N·m
Y92E-J12S18	1.2 N·m	1.2 N·m
Y92E-J18S30	5 N·m	3.5 N·m



## Enables easier and standardized designs previously not possible



- The world's longest sensing distance\*<sup>1</sup>  
Nearly double the sensing distance of previous
- With high-brightness LED, the indicator is visible anywhere from 360°.
- Only 10 Seconds\*<sup>2</sup> to Replace a Proximity Sensor with the "e-jig" (Mounting Sleeve).
- Cables with enhanced oil resistance enabled 2-year oil resistance\*<sup>3</sup>.
- IP69K compliant for water resistance and wash resistance\*<sup>4</sup>
- Comes in a wide variation to make sensor selection easy
- UL certification (UL60947-5-2)\*<sup>5</sup> and CSA certification (CSA C22.2 UL60947-5-2-14)



For the most recent information on models that have been certified for safety standards, refer to your OMRON website.

\*1. Based on December 2018 OMRON investigation.  
 \*2. Time required to adjust the distance when installing a Sensor. Based on OMRON investigation.  
 \*3. Refer to *Ratings and Specifications* for details. However, E2E Connector Models and E2EQ series is excluded.  
 \*4. E2EQ series is excluded.  
 \*5. M8 (4-pin) Connector Models are not UL certified.

Be sure to read *Safety Precautions* on page 81.

## Features

PREMIUM Model

Easy design    Standardized design

Exceptional sensing range\*<sup>6</sup>

**9** [M12] mm\*<sup>7</sup>

The PREMIUM Model, which has a longer detection range compared to previous models, allows for more spacious designs with less risk of contact. It also enables you to standardize your designs by letting you adopt a single one-size model instead of multiple models of different sizes.

\*6. Based on December 2018 OMRON investigation.  
 \*7. Quadruple distance models of M12 sized

Quadruple distance model

9mm [M12]

Triple distance model

6mm [M12]

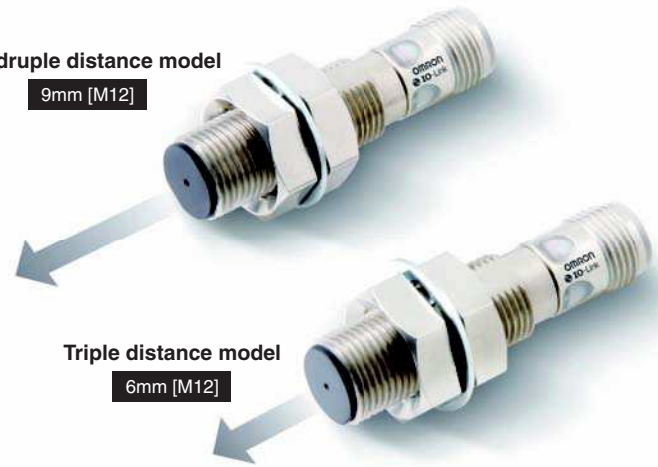

## New standards for usability

### Early error detection

**1** location, all new E2E Sensors can be monitored with IO-Link IO-Link

### Less unexpected facility stoppages

Strong resistance to cutting oil **2**-year oil resistance\*<sup>9</sup>

### Quick recovery

**10** second replaceable with e-jig (adaptor) \*<sup>8</sup>  
**360°** degree view with high visibility LED indicator

\*8. Time required to adjust the distance when installing a Sensor. Based on OMRON investigation.

\*9. E2E Connector Models and E2EQ series is excluded.

BASIC Model

In addition to our HIGH SPEC Models, we also offer mid/short-distance BASIC Models, to meet various facility design requirement specifications.

Double distance model

4mm [M12]

Single distance model

2mm [M12]



## E2E/E2EQ NEXT Series

### E2E/E2EQ NEXT Series Model Number Legend

#### DC 3-wire

E2E (1) - X (2) (3) (4) (5) (6) (7) - (8) - (9) - (10) (11)

No.	Type	Code	Meaning
(1)	Case	Blank	Without spatter-resistant coating
		Q	With spatter-resistant coating
(2)	Sensing distance	Number	Sensing distance (Unit: mm) (R: Indication of decimal point)
(3)	Shielding	Blank	Shielded
		M	Unshielded
(4)	Output configuration	B	PNP open collector
		C	NPN open collector
(5)	Operation mode	1	Normally open (NO)
		2	Normally closed (NC)
		3	Normally open, Normally closed (NO+NC)
(6)	IO-Link baud rate	Blank	IO-Link baud rate
		D	COM2 (38.4 kbps)
		T	COM3 (230.4 kbps)
(7)	Body size	Blank	Standard
		L	Long Body
(8)	Size	8	M8
		12	M12
		18	M18
		30	M30
(9)	Connection method	Blank	Pre-wired Models
		M1	M12 Connector Models
		M3	M8 (4-pin) Connector Models
		M5	M8 (3-pin) Connector Models
		M1TJ	M12 Pre-wired Smartclick Connector Models
		M1TJR	M12 Pre-wired Smartclick Connector Models Robot (bending-resistant) cable
(10)	Cable specifications *	Blank	Standard PVC cable
		R	Robot (bending-resistant) cable
(11)	Cable length	Number M	Cable length

\* (10) is only shown in the model number of Pre-wired Models.

**Note:** The purpose of this model number legend is to provide understanding of the meaning of specifications from the model number. Models are not available for all combinations of code numbers.



## Ordering Information

PREMIUM Model

## E2E NEXT Series (Quadruple distance model)

DC 3-wire [Refer to *Dimensions* on page 84.]

Shielded \*1

Size (Sensing distance)	Connection method	Body size	Operation mode	Model		
				PNP	NPN	
M8 (4 mm)	Pre-wired (2 m) *2	38 mm *3	NO	E2E-X4B1D8 2M	E2E-X4C18 2M	
			NC	E2E-X4B28 2M	E2E-X4C28 2M	
		48 mm	NO	E2E-X4B1DL8 2M	E2E-X4C1L8 2M	
			NC	E2E-X4B2L8 2M	E2E-X4C2L8 2M	
	M12 Pre-wired Smartclick Connector (0.3 m)	38 mm *4	NO	E2E-X4B1D8-M1TJ 0.3M	E2E-X4C18-M1TJ 0.3M	
			NC	E2E-X4B28-M1TJ 0.3M	E2E-X4C28-M1TJ 0.3M	
		48 mm	NO	E2E-X4B1DL8-M1TJ 0.3M	E2E-X4C1L8-M1TJ 0.3M	
			NC	E2E-X4B2L8-M1TJ 0.3M	E2E-X4C2L8-M1TJ 0.3M	
	M12 Connector	43 mm	NO	E2E-X4B1D8-M1	E2E-X4C18-M1	
			NC	E2E-X4B28-M1	E2E-X4C28-M1	
		53 mm	NO	E2E-X4B1DL8-M1	E2E-X4C1L8-M1	
			NC	E2E-X4B2L8-M1	E2E-X4C2L8-M1	
	M8 Connector (4-pin)	39 mm	NO	E2E-X4B1D8-M3	E2E-X4C18-M3	
			NC	E2E-X4B28-M3	E2E-X4C28-M3	
		49 mm	NO	E2E-X4B1DL8-M3	E2E-X4C1L8-M3	
			NC	E2E-X4B2L8-M3	E2E-X4C2L8-M3	
	M8 Connector (3-pin)	39 mm	NO	E2E-X4B1D8-M5	E2E-X4C18-M5	
			NC	E2E-X4B28-M5	E2E-X4C28-M5	
		49 mm	NO	E2E-X4B1DL8-M5	E2E-X4C1L8-M5	
			NC	E2E-X4B2L8-M5	E2E-X4C2L8-M5	
	M12 (9 mm)	Pre-wired (2 m) *2	47 mm *3	NO	E2E-X9B1D12 2M	E2E-X9C112 2M
				NC	E2E-X9B212 2M	E2E-X9C212 2M
			69 mm	NO	E2E-X9B1DL12 2M	E2E-X9C1L12 2M
				NC	E2E-X9B2L12 2M	E2E-X9C2L12 2M
M12 Pre-wired Smartclick Connector (0.3 m)		47 mm *4	NO	E2E-X9B1D12-M1TJ 0.3M	E2E-X9C112-M1TJ 0.3M	
			NC	E2E-X9B212-M1TJ 0.3M	E2E-X9C212-M1TJ 0.3M	
		69 mm	NO	E2E-X9B1DL12-M1TJ 0.3M	E2E-X9C1L12-M1TJ 0.3M	
			NC	E2E-X9B2L12-M1TJ 0.3M	E2E-X9C2L12-M1TJ 0.3M	
M12 Connector		48 mm	NO	E2E-X9B1D12-M1	E2E-X9C112-M1	
			NC	E2E-X9B212-M1	E2E-X9C212-M1	
		70 mm	NO	E2E-X9B1DL12-M1	E2E-X9C1L12-M1	
			NC	E2E-X9B2L12-M1	E2E-X9C2L12-M1	
M18 (14 mm)	Pre-wired (2 m) *2	55 mm *3	NO	E2E-X14B1D18 2M	E2E-X14C118 2M	
			NC	E2E-X14B218 2M	E2E-X14C218 2M	
		77 mm	NO	E2E-X14B1DL18 2M	E2E-X14C1L18 2M	
			NC	E2E-X14B2L18 2M	E2E-X14C2L18 2M	
	M12 Pre-wired Smartclick Connector (0.3 m)	55 mm *4	NO	E2E-X14B1D18-M1TJ 0.3M	E2E-X14C118-M1TJ 0.3M	
			NC	E2E-X14B218-M1TJ 0.3M	E2E-X14C218-M1TJ 0.3M	
		77 mm	NO	E2E-X14B1DL18-M1TJ 0.3M	E2E-X14C1L18-M1TJ 0.3M	
			NC	E2E-X14B2L18-M1TJ 0.3M	E2E-X14C2L18-M1TJ 0.3M	
	M12 Connector	53 mm	NO	E2E-X14B1D18-M1	E2E-X14C118-M1	
			NC	E2E-X14B218-M1	E2E-X14C218-M1	
		75 mm	NO	E2E-X14B1DL18-M1	E2E-X14C1L18-M1	
			NC	E2E-X14B2L18-M1	E2E-X14C2L18-M1	

E2E/E2EQ NEXT Series DC 2-wire

E2E/E2EQ NEXT Series DC 3-wire

XS5 NEXT Series

XS5

XS3

# E2E/E2EQ NEXT Series

## PREMIUM Model

Size (Sensing distance)	Connection method	Body size	Operation mode	Model	
				PNP	NPN
M30 (23 mm)	Pre-wired (2 m) *2	60 mm *2	NO	E2E-X23B1D30 2M	E2E-X23C130 2M
			NC	E2E-X23B230 2M	E2E-X23C230 2M
		82 mm	NO	E2E-X23B1DL30 2M	E2E-X23C1L30 2M
			NC	E2E-X23B2L30 2M	E2E-X23C2L30 2M
	M12 Pre-wired Smartclick Connector (0.3 m)	60 mm *4	NO	E2E-X23B1D30-M1TJ 0.3M	E2E-X23C130-M1TJ 0.3M
			NC	E2E-X23B230-M1TJ 0.3M	E2E-X23C230-M1TJ 0.3M
		82 mm	NO	E2E-X23B1DL30-M1TJ 0.3M	E2E-X23C1L30-M1TJ 0.3M
			NC	E2E-X23B2L30-M1TJ 0.3M	E2E-X23C2L30-M1TJ 0.3M
	M12 Connector	58 mm	NO	E2E-X23B1D30-M1	E2E-X23C130-M1
			NC	E2E-X23B230-M1	E2E-X23C230-M1
		80 mm	NO	E2E-X23B1DL30-M1	E2E-X23C1L30-M1
			NC	E2E-X23B2L30-M1	E2E-X23C2L30-M1

\*1. When embedding the Proximity Sensor in metal, refer to *Influence of Surrounding Metal* on page 82.

\*2. Models with 5-m cable length are also available with "5M" suffix. (Example: E2E-X9B1D12 5M)

\*3. Models with 2-m and 5-m robot (bending-resistant) cables are also available with "-R" in the model number. (Example: E2E-X9B1D12-R 2M/ E2E-X9B1D12-R 5M)

\*4. Models with M12 Smartclick connector model robot (bending-resistant) cables are also available with "R" in the model number. (Example: E2E-X9B1D12-M1TJR 0.3M)

**Note: 1.** Models in   are equipped with IO-Link (COM2). For IO-Link (COM3), select a model number with the format of "E2E-X□□□□□" (Example: E2E-X9B1T12 2M).

Operation mode NO can be changed to NC via IO-Link communications.

**2.** IO-Link is not supported for NC-type PNP outputs or all types of NPN outputs.

PREMIUM Model

E2E NEXT Series (Quadruple distance model)

DC 3-wire [Refer to Dimensions on page 84.]

Unshielded

Size (Sensing distance)	Connection method	Body size	Operation mode	Model	
				PNP	NPN
M8 (8 mm)	Pre-wired (2 m) *1	38 mm *2	NO	E2E-X8MB1D8 2M	E2E-X8MC18 2M
			NC	E2E-X8MB28 2M	E2E-X8MC28 2M
		48 mm	NO	E2E-X8MB1DL8 2M	E2E-X8MC1L8 2M
			NC	E2E-X8MB2L8 2M	E2E-X8MC2L8 2M
	M12 Pre-wired Smartclick Connector (0.3 m)	38 mm *3	NO	E2E-X8MB1D8-M1TJ 0.3M	E2E-X8MC18-M1TJ 0.3M
			NC	E2E-X8MB28-M1TJ 0.3M	E2E-X8MC28-M1TJ 0.3M
		48 mm	NO	E2E-X8MB1DL8-M1TJ 0.3M	E2E-X8MC1L8-M1TJ 0.3M
			NC	E2E-X8MB2L8-M1TJ 0.3M	E2E-X8MC2L8-M1TJ 0.3M
	M12 Connector	43 mm	NO	E2E-X8MB1D8-M1	E2E-X8MC18-M1
			NC	E2E-X8MB28-M1	E2E-X8MC28-M1
		53 mm	NO	E2E-X8MB1DL8-M1	E2E-X8MC1L8-M1
			NC	E2E-X8MB2L8-M1	E2E-X8MC2L8-M1
	M8 Connector (4-pin)	39 mm	NO	E2E-X8MB1D8-M3	E2E-X8MC18-M3
			NC	E2E-X8MB28-M3	E2E-X8MC28-M3
		49 mm	NO	E2E-X8MB1DL8-M3	E2E-X8MC1L8-M3
			NC	E2E-X8MB2L8-M3	E2E-X8MC2L8-M3
	M8 Connector (3-pin)	39 mm	NO	E2E-X8MB1D8-M5	E2E-X8MC18-M5
			NC	E2E-X8MB28-M5	E2E-X8MC28-M5
49 mm		NO	E2E-X8MB1DL8-M5	E2E-X8MC1L8-M5	
		NC	E2E-X8MB2L8-M5	E2E-X8MC2L8-M5	
M12 (16 mm)	Pre-wired (2 m) *1	47 mm *2	NO	E2E-X16MB1D12 2M	E2E-X16MC112 2M
			NC	E2E-X16MB212 2M	E2E-X16MC212 2M
		69 mm	NO	E2E-X16MB1DL12 2M	E2E-X16MC1L12 2M
			NC	E2E-X16MB2L12 2M	E2E-X16MC2L12 2M
	M12 Pre-wired Smartclick Connector (0.3 m)	47 mm *3	NO	E2E-X16MB1D12-M1TJ 0.3M	E2E-X16MC112-M1TJ 0.3M
			NC	E2E-X16MB212-M1TJ 0.3M	E2E-X16MC212-M1TJ 0.3M
		69 mm	NO	E2E-X16MB1DL12-M1TJ 0.3M	E2E-X16MC1L12-M1TJ 0.3M
			NC	E2E-X16MB2L12-M1TJ 0.3M	E2E-X16MC2L12-M1TJ 0.3M
	M12 Connector	48 mm	NO	E2E-X16MB1D12-M1	E2E-X16MC112-M1
			NC	E2E-X16MB212-M1	E2E-X16MC212-M1
		70 mm	NO	E2E-X16MB1DL12-M1	E2E-X16MC1L12-M1
			NC	E2E-X16MB2L12-M1	E2E-X16MC2L12-M1
M18 (30 mm)	Pre-wired (2 m) *1	77 mm *2	NO	E2E-X30MB1DL18 2M	E2E-X30MC1L18 2M
			NC	E2E-X30MB2L18 2M	E2E-X30MC2L18 2M
	M12 Pre-wired Smartclick Connector (0.3 m)	77 mm *3	NO	E2E-X30MB1DL18-M1TJ 0.3M	E2E-X30MC1L18-M1TJ 0.3M
			NC	E2E-X30MB2L18-M1TJ 0.3M	E2E-X30MC2L18-M1TJ 0.3M
	M12 Connector	75 mm	NO	E2E-X30MB1DL18-M1	E2E-X30MC1L18-M1
			NC	E2E-X30MB2L18-M1	E2E-X30MC2L18-M1
M30 (50 mm)	Pre-wired (2 m) *1	97 mm *2	NO	E2E-X50MB1DL30 2M	E2E-X50MC1L30 2M
			NC	E2E-X50MB2L30 2M	E2E-X50MC2L30 2M
	M12 Pre-wired Smartclick Connector (0.3 m)	97 mm *3	NO	E2E-X50MB1DL30-M1TJ 0.3M	E2E-X50MC1L30-M1TJ 0.3M
			NC	E2E-X50MB2L30-M1TJ 0.3M	E2E-X50MC2L30-M1TJ 0.3M
	M12 Connector	95 mm	NO	E2E-X50MB1DL30-M1	E2E-X50MC1L30-M1
			NC	E2E-X50MB2L30-M1	E2E-X50MC2L30-M1

\*1. Models with 5-m cable length are also available (Example: E2E-X16MB1D12 5M)

\*2. Models with 2-m and 5-m robot (bending-resistant) cables are also available with "-R" in the model number. (Example: E2E-X16MB1D12-R 2M/E2E-X16MB1D12-R 5M)

\*3. Models with M12 Smartclick connector model robot (bending-resistant) cables are also available with "R" in the model number. (Example: E2E-X16MB1D12-M1TJR 0.3M)

**Note:** 1. Models in   are equipped with IO-Link (COM2). For IO-Link (COM3), select a model number with the format of "E2E-X     " (Example: E2E-X16MB1T12 2M).

Operation mode NO can be changed to NC via IO-Link communications.

2. IO-Link is not supported for NC-type PNP outputs or all types of NPN outputs.

# E2E/E2EQ NEXT Series

PREMIUM Model

## E2E NEXT Series (Triple distance model)

DC 3-wire [Refer to *Dimensions* on page 84.]

Shielded \*1

Size (Sensing distance)	Connection method	Body size	Operation mode	Model		
				PNP	NPN	
M8 (3 mm)	Pre-wired (2 m) *2	38 mm *3	NO	E2E-X3B1D8 2M	E2E-X3C18 2M	
			NC	E2E-X3B28 2M	E2E-X3C28 2M	
		48 mm	NO	E2E-X3B1DL8 2M	E2E-X3C1L8 2M	
			NC	E2E-X3B2L8 2M	E2E-X3C2L8 2M	
	M12 Pre-wired Smartclick Connector (0.3 m)	38 mm *4	NO	E2E-X3B1D8-M1TJ 0.3M	E2E-X3C18-M1TJ 0.3M	
			NC	E2E-X3B28-M1TJ 0.3M	E2E-X3C28-M1TJ 0.3M	
		48 mm	NO	E2E-X3B1DL8-M1TJ 0.3M	E2E-X3C1L8-M1TJ 0.3M	
			NC	E2E-X3B2L8-M1TJ 0.3M	E2E-X3C2L8-M1TJ 0.3M	
	M12 Connector	43 mm	NO	E2E-X3B1D8-M1	E2E-X3C18-M1	
			NC	E2E-X3B28-M1	E2E-X3C28-M1	
		53 mm	NO	E2E-X3B1DL8-M1	E2E-X3C1L8-M1	
			NC	E2E-X3B2L8-M1	E2E-X3C2L8-M1	
	M8 Connector (4-pin)	39 mm	NO	E2E-X3B1D8-M3	E2E-X3C18-M3	
			NC	E2E-X3B28-M3	E2E-X3C28-M3	
		49 mm	NO	E2E-X3B1DL8-M3	E2E-X3C1L8-M3	
			NC	E2E-X3B2L8-M3	E2E-X3C2L8-M3	
	M8 Connector (3-pin)	39 mm	NO	E2E-X3B1D8-M5	E2E-X3C18-M5	
			NC	E2E-X3B28-M5	E2E-X3C28-M5	
		49 mm	NO	E2E-X3B1DL8-M5	E2E-X3C1L8-M5	
			NC	E2E-X3B2L8-M5	E2E-X3C2L8-M5	
	M12 (6 mm)	Pre-wired (2 m) *2	47 mm *3	NO	E2E-X6B1D12 2M	E2E-X6C112 2M
				NC	E2E-X6B212 2M	E2E-X6C212 2M
				NO+NC	E2E-X6B3D12 2M	E2E-X6C312 2M
			69 mm	NO	E2E-X6B1DL12 2M	E2E-X6C1L12 2M
NC				E2E-X6B2L12 2M	E2E-X6C2L12 2M	
NO+NC				E2E-X6B3DL12 2M	E2E-X6C3L12 2M	
M12 Pre-wired Smartclick Connector (0.3 m)			47 mm *4	NO	E2E-X6B1D12-M1TJ 0.3M	E2E-X6C112-M1TJ 0.3M
				NC	E2E-X6B212-M1TJ 0.3M	E2E-X6C212-M1TJ 0.3M
		NO+NC		E2E-X6B3D12-M1TJ 0.3M	E2E-X6C312-M1TJ 0.3M	
		69 mm	NO	E2E-X6B1DL12-M1TJ 0.3M	E2E-X6C1L12-M1TJ 0.3M	
			NC	E2E-X6B2L12-M1TJ 0.3M	E2E-X6C2L12-M1TJ 0.3M	
			NO+NC	E2E-X6B3DL12-M1TJ 0.3M	E2E-X6C3L12-M1TJ 0.3M	
M12 Connector		48 mm	NO	E2E-X6B1D12-M1	E2E-X6C112-M1	
			NC	E2E-X6B212-M1	E2E-X6C212-M1	
			NO+NC	E2E-X6B3D12-M1	E2E-X6C312-M1	
		70 mm	NO	E2E-X6B1DL12-M1	E2E-X6C1L12-M1	
			NC	E2E-X6B2L12-M1	E2E-X6C2L12-M1	
			NO+NC	E2E-X6B3DL12-M1	E2E-X6C3L12-M1	

**PREMIUM Model**

Size (Sensing distance)	Connection method	Body size	Operation mode	Model	
				PNP	NPN
M18 (12 mm)	Pre-wired (2 m) *2	55 mm *3	NO	E2E-X12B1D18 2M	E2E-X12C118 2M
			NC	E2E-X12B218 2M	E2E-X12C218 2M
			NO+NC	E2E-X12B3D18 2M	E2E-X12C318 2M
		77 mm	NO	E2E-X12B1DL18 2M	E2E-X12C1L18 2M
			NC	E2E-X12B2L18 2M	E2E-X12C2L18 2M
			NO+NC	E2E-X12B3DL18 2M	E2E-X12C3L18 2M
	M12 Pre-wired Smartclick Connector (0.3 m)	55 mm *4	NO	E2E-X12B1D18-M1TJ 0.3M	E2E-X12C118-M1TJ 0.3M
			NC	E2E-X12B218-M1TJ 0.3M	E2E-X12C218-M1TJ 0.3M
			NO+NC	E2E-X12B3D18-M1TJ 0.3M	E2E-X12C318-M1TJ 0.3M
		77 mm	NO	E2E-X12B1DL18-M1TJ 0.3M	E2E-X12C1L18-M1TJ 0.3M
			NC	E2E-X12B2L18-M1TJ 0.3M	E2E-X12C2L18-M1TJ 0.3M
			NO+NC	E2E-X12B3DL18-M1TJ 0.3M	E2E-X12C3L18-M1TJ 0.3M
	M12 Connector	53 mm	NO	E2E-X12B1D18-M1	E2E-X12C118-M1
			NC	E2E-X12B218-M1	E2E-X12C218-M1
			NO+NC	E2E-X12B3D18-M1	E2E-X12C318-M1
		75 mm	NO	E2E-X12B1DL18-M1	E2E-X12C1L18-M1
			NC	E2E-X12B2L18-M1	E2E-X12C2L18-M1
			NO+NC	E2E-X12B3DL18-M1	E2E-X12C3L18-M1
M30 (22 mm)	Pre-wired (2 m) *2	60 mm *3	NO	E2E-X22B1D30 2M	E2E-X22C130 2M
			NC	E2E-X22B230 2M	E2E-X22C230 2M
			NO+NC	E2E-X22B3D30 2M	E2E-X22C330 2M
		82 mm	NO	E2E-X22B1DL30 2M	E2E-X22C1L30 2M
			NC	E2E-X22B2L30 2M	E2E-X22C2L30 2M
			NO+NC	E2E-X22B3DL30 2M	E2E-X22C3L30 2M
	M12 Pre-wired Smartclick Connector (0.3 m)	60 mm *4	NO	E2E-X22B1D30-M1TJ 0.3M	E2E-X22C130-M1TJ 0.3M
			NC	E2E-X22B230-M1TJ 0.3M	E2E-X22C230-M1TJ 0.3M
			NO+NC	E2E-X22B3D30-M1TJ 0.3M	E2E-X22C330-M1TJ 0.3M
		82 mm	NO	E2E-X22B1DL30-M1TJ 0.3M	E2E-X22C1L30-M1TJ 0.3M
			NC	E2E-X22B2L30-M1TJ 0.3M	E2E-X22C2L30-M1TJ 0.3M
			NO+NC	E2E-X22B3DL30-M1TJ 0.3M	E2E-X22C3L30-M1TJ 0.3M
	M12 Connector	58 mm	NO	E2E-X22B1D30-M1	E2E-X22C130-M1
			NC	E2E-X22B230-M1	E2E-X22C230-M1
			NO+NC	E2E-X22B3D30-M1	E2E-X22C330-M1
		80 mm	NO	E2E-X22B1DL30-M1	E2E-X22C1L30-M1
			NC	E2E-X22B2L30-M1	E2E-X22C2L30-M1
			NO+NC	E2E-X22B3DL30-M1	E2E-X22C3L30-M1

\*1. When embedding the Proximity Sensor in metal, refer to *Influence of Surrounding Metal* on page 82.

\*2. Models with 5-m cable length are also available (Example: E2E-X6B1D12 5M)

\*3. Models with 2-m and 5-m robot (bending-resistant) cables are also available with "-R" in the model number. (Example: E2E-X6B1D12-R 2M/ E2E-X6B1D12-R 5M)

\*4. Models with M12 Smartclick connector model robot (bending-resistant) cables are also available with "R" in the model number. (Example: E2E-X6B1D12-M1TJR 0.3M)

**Note:** 1. Models in   are equipped with IO-Link (COM2). For IO-Link (COM3), select a model number with the format of "E2E-X    " (Example: E2E-X6B1T12 2M).

Operation mode NO can be changed to NC via IO-Link communications.

2. IO-Link is not supported for NC-type PNP outputs or all types of NPN outputs.

# E2E/E2EQ NEXT Series

**PREMIUM Model**

## E2E NEXT Series (Triple distance model)

DC 3-wire [Refer to *Dimensions* on page 84.]

Unshielded

Size (Sensing distance)	Connection method	Body size	Operation mode	Model		
				PNP	NPN	
M8 (6 mm)	Pre-wired (2 m) *1	38 mm *2	NO	E2E-X6MB1D8 2M	E2E-X6MC18 2M	
			NC	E2E-X6MB28 2M	E2E-X6MC28 2M	
		48 mm	NO	E2E-X6MB1DL8 2M	E2E-X6MC1L8 2M	
			NC	E2E-X6MB2L8 2M	E2E-X6MC2L8 2M	
	M12 Pre-wired Smartclick Connector (0.3 m)	38 mm *3	NO	E2E-X6MB1D8-M1TJ 0.3M	E2E-X6MC18-M1TJ 0.3M	
			NC	E2E-X6MB28-M1TJ 0.3M	E2E-X6MC28-M1TJ 0.3M	
		48 mm	NO	E2E-X6MB1DL8-M1TJ 0.3M	E2E-X6MC1L8-M1TJ 0.3M	
			NC	E2E-X6MB2L8-M1TJ 0.3M	E2E-X6MC2L8-M1TJ 0.3M	
	M12 Connector	43 mm	NO	E2E-X6MB1D8-M1	E2E-X6MC18-M1	
			NC	E2E-X6MB28-M1	E2E-X6MC28-M1	
		53 mm	NO	E2E-X6MB1DL8-M1	E2E-X6MC1L8-M1	
			NC	E2E-X6MB2L8-M1	E2E-X6MC2L8-M1	
	M8 Connector (4-pin)	39 mm	NO	E2E-X6MB1D8-M3	E2E-X6MC18-M3	
			NC	E2E-X6MB28-M3	E2E-X6MC28-M3	
		49 mm	NO	E2E-X6MB1DL8-M3	E2E-X6MC1L8-M3	
			NC	E2E-X6MB2L8-M3	E2E-X6MC2L8-M3	
	M8 Connector (3-pin)	39 mm	NO	E2E-X6MB1D8-M5	E2E-X6MC18-M5	
			NC	E2E-X6MB28-M5	E2E-X6MC28-M5	
		49 mm	NO	E2E-X6MB1DL8-M5	E2E-X6MC1L8-M5	
			NC	E2E-X6MB2L8-M5	E2E-X6MC2L8-M5	
	M12 (10 mm)	Pre-wired (2 m) *1	47 mm *2	NO	E2E-X10MB1D12 2M	E2E-X10MC112 2M
				NC	E2E-X10MB212 2M	E2E-X10MC212 2M
				NO+NC	E2E-X10MB3D12 2M	E2E-X10MC312 2M
				NO	E2E-X10MB1DL12 2M	E2E-X10MC1L12 2M
69 mm			NC	E2E-X10MB2L12 2M	E2E-X10MC2L12 2M	
			NO+NC	E2E-X10MB3DL12 2M	E2E-X10MC3L12 2M	
			NO	E2E-X10MB1D12-M1TJ 0.3M	E2E-X10MC112-M1TJ 0.3M	
			NC	E2E-X10MB212-M1TJ 0.3M	E2E-X10MC212-M1TJ 0.3M	
M12 Pre-wired Smartclick Connector (0.3 m)		47 mm *3	NO+NC	E2E-X10MB3D12-M1TJ 0.3M	E2E-X10MC312-M1TJ 0.3M	
			NO	E2E-X10MB1DL12-M1TJ 0.3M	E2E-X10MC1L12-M1TJ 0.3M	
		69 mm	NC	E2E-X10MB2L12-M1TJ 0.3M	E2E-X10MC2L12-M1TJ 0.3M	
			NO+NC	E2E-X10MB3DL12-M1TJ 0.3M	E2E-X10MC3L12-M1TJ 0.3M	
M12 Connector		48 mm	NO	E2E-X10MB1D12-M1	E2E-X10MC112-M1	
			NC	E2E-X10MB212-M1	E2E-X10MC212-M1	
			NO+NC	E2E-X10MB3D12-M1	E2E-X10MC312-M1	
		70 mm	NO	E2E-X10MB1DL12-M1	E2E-X10MC1L12-M1	
			NC	E2E-X10MB2L12-M1	E2E-X10MC2L12-M1	
			NO+NC	E2E-X10MB3DL12-M1	E2E-X10MC3L12-M1	
M18 (20 mm)		Pre-wired (2 m) *1	77 mm *2	NO	E2E-X20MB1DL18 2M	E2E-X20MC1L18 2M
				NC	E2E-X20MB2L18 2M	E2E-X20MC2L18 2M
				NO+NC	E2E-X20MB3DL18 2M	E2E-X20MC3L18 2M
		M12 Pre-wired Smartclick Connector (0.3 m)	77 mm *3	NO	E2E-X20MB1DL18-M1TJ 0.3M	E2E-X20MC1L18-M1TJ 0.3M
				NC	E2E-X20MB2L18-M1TJ 0.3M	E2E-X20MC2L18-M1TJ 0.3M
				NO+NC	E2E-X20MB3DL18-M1TJ 0.3M	E2E-X20MC3L18-M1TJ 0.3M
	M12 Connector	75 mm	NO	E2E-X20MB1DL18-M1	E2E-X20MC1L18-M1	
			NC	E2E-X20MB2L18-M1	E2E-X20MC2L18-M1	
			NO+NC	E2E-X20MB3DL18-M1	E2E-X20MC3L18-M1	

**PREMIUM Model**

Size (Sensing distance)	Connection method	Body size	Operation mode	Model	
				PNP	NPN
M30 (40 mm)	Pre-wired (2 m) *1	82 mm *2	NO	E2E-X40MB1DL30 2M	E2E-X40MC1L30 2M
			NC	E2E-X40MB2L30 2M	E2E-X40MC2L30 2M
			NO+NC	E2E-X40MB3DL30 2M	E2E-X40MC3L30 2M
	M12 Pre-wired Smartclick Connector (0.3 m)	82 mm *3	NO	E2E-X40MB1DL30-M1TJ 0.3M	E2E-X40MC1L30-M1TJ 0.3M
			NC	E2E-X40MB2L30-M1TJ 0.3M	E2E-X40MC2L30-M1TJ 0.3M
			NO+NC	E2E-X40MB3DL30-M1TJ 0.3M	E2E-X40MC3L30-M1TJ 0.3M
	M12 Connector	80 mm	NO	E2E-X40MB1DL30-M1	E2E-X40MC1L30-M1
			NC	E2E-X40MB2L30-M1	E2E-X40MC2L30-M1
			NO+NC	E2E-X40MB3DL30-M1	E2E-X40MC3L30-M1

\*1. Models with 5-m cable length are also available (Example: E2E-X10MB1D12 5M)

\*2. Models with 2-m and 5-m robot (bending-resistant) cables are also available with "-R" in the model number. (Example: E2E-X10MB1D12-R 2M/E2E-X10MB1D12-R 5M)

\*3. Models with M12 Smartclick connector model robot (bending-resistant) cables are also available with "R" in the model number. (Example: E2E-X10MB1D12-M1TJR 0.3M)

**Note:** 1. Models in   are equipped with IO-Link (COM2). For IO-Link (COM3), select a model number with the format of "E2E-X    T " (Example: E2E-X10MB1T12 2M).

Operation mode NO can be changed to NC via IO-Link communications.

2. IO-Link is not supported for NC-type PNP outputs or all types of NPN outputs.



# E2E/E2EQ NEXT Series

## PREMIUM Model

### E2EQ NEXT Series (Spatter-resistant Triple distance model)

DC 3-wire [Refer to *Dimensions* on page 84.]

Shielded \*1

Size (Sensing distance)	Connection method	Body size	Operation mode	Model	
				PNP	NPN
M8 (3 mm)	Pre-wired (2 m) *2	38 mm	NO	E2EQ-X3B1D8 2M	E2EQ-X3C18 2M
			NC	E2EQ-X3B28 2M	E2EQ-X3C28 2M
	M12 Pre-wired Smartclick Connector (0.3 m)	38 mm	NO	E2EQ-X3B1D8-M1TJ 0.3M	E2EQ-X3C18-M1TJ 0.3M
			NC	E2EQ-X3B28-M1TJ 0.3M	E2EQ-X3C28-M1TJ 0.3M
	M12 Connector	43 mm	NO	E2EQ-X3B1D8-M1	E2EQ-X3C18-M1
			NC	E2EQ-X3B28-M1	E2EQ-X3C28-M1
M12 (6 mm)	Pre-wired (2 m) *2	47 mm	NO	E2EQ-X6B1D12 2M	E2EQ-X6C112 2M
			NC	E2EQ-X6B212 2M	E2EQ-X6C212 2M
			NO+NC	E2EQ-X6B3D12 2M	E2EQ-X6C312 2M
	M12 Pre-wired Smartclick Connector (0.3 m)	47 mm	NO	E2EQ-X6B1D12-M1TJ 0.3M	E2EQ-X6C112-M1TJ 0.3M
			NC	E2EQ-X6B212-M1TJ 0.3M	E2EQ-X6C212-M1TJ 0.3M
			NO+NC	E2EQ-X6B3D12-M1TJ 0.3M	E2EQ-X6C312-M1TJ 0.3M
	M12 Connector	48 mm	NO	E2EQ-X6B1D12-M1	E2EQ-X6C112-M1
			NC	E2EQ-X6B212-M1	E2EQ-X6C212-M1
			NO+NC	E2EQ-X6B3D12-M1	E2EQ-X6C312-M1
M18 (12 mm)	Pre-wired (2 m) *2	55 mm	NO	E2EQ-X12B1D18 2M	E2EQ-X12C118 2M
			NC	E2EQ-X12B218 2M	E2EQ-X12C218 2M
			NO+NC	E2EQ-X12B3D18 2M	E2EQ-X12C318 2M
	M12 Pre-wired Smartclick Connector (0.3 m)	55 mm	NO	E2EQ-X12B1D18-M1TJ 0.3M	E2EQ-X12C118-M1TJ 0.3M
			NC	E2EQ-X12B218-M1TJ 0.3M	E2EQ-X12C218-M1TJ 0.3M
			NO+NC	E2EQ-X12B3D18-M1TJ 0.3M	E2EQ-X12C318-M1TJ 0.3M
	M12 Connector	53 mm	NO	E2EQ-X12B1D18-M1	E2EQ-X12C118-M1
			NC	E2EQ-X12B218-M1	E2EQ-X12C218-M1
			NO+NC	E2EQ-X12B3D18-M1	E2EQ-X12C318-M1
M30 (22 mm)	Pre-wired (2 m) *2	60 mm	NO	E2EQ-X22B1D30 2M	E2EQ-X22C130 2M
			NC	E2EQ-X22B230 2M	E2EQ-X22C230 2M
			NO+NC	E2EQ-X22B3D30 2M	E2EQ-X22C330 2M
	M12 Pre-wired Smartclick Connector (0.3 m)	60 mm	NO	E2EQ-X22B1D30-M1TJ 0.3M	E2EQ-X22C130-M1TJ 0.3M
			NC	E2EQ-X22B230-M1TJ 0.3M	E2EQ-X22C230-M1TJ 0.3M
			NO+NC	E2EQ-X22B3D30-M1TJ 0.3M	E2EQ-X22C330-M1TJ 0.3M
	M12 Connector	58 mm	NO	E2EQ-X22B1D30-M1	E2EQ-X22C130-M1
			NC	E2EQ-X22B230-M1	E2EQ-X22C230-M1
			NO+NC	E2EQ-X22B3D30-M1	E2EQ-X22C330-M1

\*1. When embedding the Proximity Sensor in metal, refer to *Influence of Surrounding Metal* on page 82.

\*2. Models with 5-m cable length are also available (Example: E2EQ-X6B1D12 5M)

**Note:** 1. Models in   are equipped with IO-Link (COM2). For IO-Link (COM3), select a model number with the format of "E2E-X□□□T□" (Example: E2EQ-X6B1T12 2M).

Operation mode NO can be changed to NC via IO-Link communications.

2. IO-Link is not supported for NC-type PNP outputs or all types of NPN outputs.

BASIC Model

E2E NEXT Series (Double distance model)

DC 3-wire [Refer to Dimensions on page 85.]

Shielded

Size (Sensing distance)	Connection method	Body size	Operation mode	Model		
				PNP	NPN	
M8 (2 mm)	Pre-wired (2 m) *1	38 mm *2	NO	E2E-X2B1D8 2M	E2E-X2C18 2M	
			NC	E2E-X2B28 2M	E2E-X2C28 2M	
		48 mm	NO	E2E-X2B1DL8 2M	E2E-X2C1L8 2M	
			NC	E2E-X2B2L8 2M	E2E-X2C2L8 2M	
	M12 Pre-wired Smartclick Connector (0.3 m)	38 mm *3	NO	E2E-X2B1D8-M1TJ 0.3M	E2E-X2C18-M1TJ 0.3M	
			NC	E2E-X2B28-M1TJ 0.3M	E2E-X2C28-M1TJ 0.3M	
		48 mm	NO	E2E-X2B1DL8-M1TJ 0.3M	E2E-X2C1L8-M1TJ 0.3M	
			NC	E2E-X2B2L8-M1TJ 0.3M	E2E-X2C2L8-M1TJ 0.3M	
	M12 Connector	43 mm	NO	E2E-X2B1D8-M1	E2E-X2C18-M1	
			NC	E2E-X2B28-M1	E2E-X2C28-M1	
		53 mm	NO	E2E-X2B1DL8-M1	E2E-X2C1L8-M1	
			NC	E2E-X2B2L8-M1	E2E-X2C2L8-M1	
	M8 Connector (4-pin)	39 mm	NO	E2E-X2B1D8-M3	E2E-X2C18-M3	
			NC	E2E-X2B28-M3	E2E-X2C28-M3	
		49 mm	NO	E2E-X2B1DL8-M3	E2E-X2C1L8-M3	
			NC	E2E-X2B2L8-M3	E2E-X2C2L8-M3	
	M8 Connector (3-pin)	39 mm	NO	E2E-X2B1D8-M5	E2E-X2C18-M5	
			NC	E2E-X2B28-M5	E2E-X2C28-M5	
		49 mm	NO	E2E-X2B1DL8-M5	E2E-X2C1L8-M5	
			NC	E2E-X2B2L8-M5	E2E-X2C2L8-M5	
	M12 (4 mm)	Pre-wired (2 m) *1	47 mm *2	NO	E2E-X4B1D12 2M	E2E-X4C112 2M
				NC	E2E-X4B212 2M	E2E-X4C212 2M
				NO+NC	E2E-X4B3D12 2M	E2E-X4C312 2M
			69 mm	NO	E2E-X4B1DL12 2M	E2E-X4C1L12 2M
NC				E2E-X4B2L12 2M	E2E-X4C2L12 2M	
NO+NC				E2E-X4B3DL12 2M	E2E-X4C3L12 2M	
M12 Pre-wired Smartclick Connector (0.3 m)		47 mm *3	NO	E2E-X4B1D12-M1TJ 0.3M	E2E-X4C112-M1TJ 0.3M	
			NC	E2E-X4B212-M1TJ 0.3M	E2E-X4C212-M1TJ 0.3M	
			NO+NC	E2E-X4B3D12-M1TJ 0.3M	E2E-X4C312-M1TJ 0.3M	
		69 mm	NO	E2E-X4B1DL12-M1TJ 0.3M	E2E-X4C1L12-M1TJ 0.3M	
			NC	E2E-X4B2L12-M1TJ 0.3M	E2E-X4C2L12-M1TJ 0.3M	
			NO+NC	E2E-X4B3DL12-M1TJ 0.3M	E2E-X4C3L12-M1TJ 0.3M	
M12 Connector		48 mm	NO	E2E-X4B1D12-M1	E2E-X4C112-M1	
			NC	E2E-X4B212-M1	E2E-X4C212-M1	
			NO+NC	E2E-X4B3D12-M1	E2E-X4C312-M1	
		70 mm	NO	E2E-X4B1DL12-M1	E2E-X4C1L12-M1	
	NC		E2E-X4B2L12-M1	E2E-X4C2L12-M1		
	NO+NC		E2E-X4B3DL12-M1	E2E-X4C3L12-M1		

E2E/E2EQ NEXT Series DC 2-wire

E2E/E2EQ NEXT Series DC 3-wire

X55 NEXT Series

X55

X53

# E2E/E2EQ NEXT Series

## BASIC Model

Size (Sensing distance)	Connection method	Body size	Operation mode	Model	
				PNP	NPN
M18 (8 mm)	Pre-wired (2 m) *1	55 mm *2	NO	E2E-X8B1D18 2M	E2E-X8C118 2M
			NC	E2E-X8B218 2M	E2E-X8C218 2M
			NO+NC	E2E-X8B3D18 2M	E2E-X8C318 2M
		77 mm	NO	E2E-X8B1DL18 2M	E2E-X8C1L18 2M
			NC	E2E-X8B2L18 2M	E2E-X8C2L18 2M
			NO+NC	E2E-X8B3DL18 2M	E2E-X8C3L18 2M
	M12 Pre-wired Smartclick Connector (0.3 m)	55 mm *3	NO	E2E-X8B1D18-M1TJ 0.3M	E2E-X8C118-M1TJ 0.3M
			NC	E2E-X8B218-M1TJ 0.3M	E2E-X8C218-M1TJ 0.3M
			NO+NC	E2E-X8B3D18-M1TJ 0.3M	E2E-X8C318-M1TJ 0.3M
		77 mm	NO	E2E-X8B1DL18-M1TJ 0.3M	E2E-X8C1L18-M1TJ 0.3M
			NC	E2E-X8B2L18-M1TJ 0.3M	E2E-X8C2L18-M1TJ 0.3M
			NO+NC	E2E-X8B3DL18-M1TJ 0.3M	E2E-X8C3L18-M1TJ 0.3M
	M12 Connector	53 mm	NO	E2E-X8B1D18-M1	E2E-X8C118-M1
			NC	E2E-X8B218-M1	E2E-X8C218-M1
			NO+NC	E2E-X8B3D18-M1	E2E-X8C318-M1
		75 mm	NO	E2E-X8B1DL18-M1	E2E-X8C1L18-M1
			NC	E2E-X8B2L18-M1	E2E-X8C2L18-M1
			NO+NC	E2E-X8B3DL18-M1	E2E-X8C3L18-M1
M30 (15 mm)	Pre-wired (2 m) *1	60 mm *2	NO	E2E-X15B1D30 2M	E2E-X15C130 2M
			NC	E2E-X15B230 2M	E2E-X15C230 2M
			NO+NC	E2E-X15B3D30 2M	E2E-X15C330 2M
		82 mm	NO	E2E-X15B1DL30 2M	E2E-X15C1L30 2M
			NC	E2E-X15B2L30 2M	E2E-X15C2L30 2M
			NO+NC	E2E-X15B3DL30 2M	E2E-X15C3L30 2M
	M12 Pre-wired Smartclick Connector (0.3 m)	60 mm *3	NO	E2E-X15B1D30-M1TJ 0.3M	E2E-X15C130-M1TJ 0.3M
			NC	E2E-X15B230-M1TJ 0.3M	E2E-X15C230-M1TJ 0.3M
			NO+NC	E2E-X15B3D30-M1TJ 0.3M	E2E-X15C330-M1TJ 0.3M
		82 mm	NO	E2E-X15B1DL30-M1TJ 0.3M	E2E-X15C1L30-M1TJ 0.3M
			NC	E2E-X15B2L30-M1TJ 0.3M	E2E-X15C2L30-M1TJ 0.3M
			NO+NC	E2E-X15B3DL30-M1TJ 0.3M	E2E-X15C3L30-M1TJ 0.3M
	M12 Connector	58 mm	NO	E2E-X15B1D30-M1	E2E-X15C130-M1
			NC	E2E-X15B230-M1	E2E-X15C230-M1
			NO+NC	E2E-X15B3D30-M1	E2E-X15C330-M1
		80 mm	NO	E2E-X15B1DL30-M1	E2E-X15C1L30-M1
			NC	E2E-X15B2L30-M1	E2E-X15C2L30-M1
			NO+NC	E2E-X15B3DL30-M1	E2E-X15C3L30-M1

\*1. Models with 5-m cable length are also available (Example: E2E-X2B1D8 5M)

\*2. Models with 2-m and 5-m robot (bending-resistant) cables are also available with "-R" in the model number. (Example: E2E-X2B1D8-R 2M/ E2E-X2B1D8-R 5M)

\*3. Models with M12 Smartclick connector model robot (bending-resistant) cables are also available with "R" in the model number. (Example: E2E-X4B1T12-M1TJR 0.3M)

**Note:** 1. Models in   are equipped with IO-Link (COM2). For IO-Link (COM3), select a model number with the format of "E2E-X□□□T□" (Example: E2E-X2B1T8 2M).

Operation mode NO can be changed to NC via IO-Link communications.

2. IO-Link is not supported for NC-type PNP outputs or all types of NPN outputs.

BASIC Model

E2E NEXT Series (Double distance model)

DC 3-wire [Refer to Dimensions on page 85.]

Unshielded

Size (Sensing distance)	Connection method	Body size	Operation mode	Model			
				PNP	NPN		
M8 (4 mm)	Pre-wired (2 m) *1	38 mm *2	NO	E2E-X4MB1D8 2M	E2E-X4MC18 2M		
			NC	E2E-X4MB28 2M	E2E-X4MC28 2M		
		48 mm	NO	E2E-X4MB1DL8 2M	E2E-X4MC1L8 2M		
			NC	E2E-X4MB2L8 2M	E2E-X4MC2L8 2M		
		M12 Pre-wired Smartclick Connector (0.3 m)	38 mm *3	NO	E2E-X4MB1D8-M1TJ 0.3M	E2E-X4MC18-M1TJ 0.3M	
				NC	E2E-X4MB28-M1TJ 0.3M	E2E-X4MC28-M1TJ 0.3M	
	48 mm		NO	E2E-X4MB1DL8-M1TJ 0.3M	E2E-X4MC1L8-M1TJ 0.3M		
			NC	E2E-X4MB2L8-M1TJ 0.3M	E2E-X4MC2L8-M1TJ 0.3M		
	M12 Connector		43 mm	NO	E2E-X4MB1D8-M1	E2E-X4MC18-M1	
				NC	E2E-X4MB28-M1	E2E-X4MC28-M1	
		53 mm	NO	E2E-X4MB1DL8-M1	E2E-X4MC1L8-M1		
			NC	E2E-X4MB2L8-M1	E2E-X4MC2L8-M1		
			NO+NC	E2E-X4MB3DL8-M1	E2E-X4MC3L8-M1		
	M8 Connector (4-pin)	39 mm	NO	E2E-X4MB1D8-M3	E2E-X4MC18-M3		
			NC	E2E-X4MB28-M3	E2E-X4MC28-M3		
		49 mm	NO	E2E-X4MB1DL8-M3	E2E-X4MC1L8-M3		
			NC	E2E-X4MB2L8-M3	E2E-X4MC2L8-M3		
		M8 Connector (3-pin)	39 mm	NO	E2E-X4MB1D8-M5	E2E-X4MC18-M5	
				NC	E2E-X4MB28-M5	E2E-X4MC28-M5	
	49 mm		NO	E2E-X4MB1DL8-M5	E2E-X4MC1L8-M5		
			NC	E2E-X4MB2L8-M5	E2E-X4MC2L8-M5		
	M12 (8 mm)		Pre-wired (2 m) *1	47 mm *2	NO	E2E-X8MB1D12 2M	E2E-X8MC112 2M
					NC	E2E-X8MB212 2M	E2E-X8MC212 2M
NO+NC		E2E-X8MB3D12 2M			E2E-X8MC312 2M		
69 mm		NO		E2E-X8MB1DL12 2M	E2E-X8MC1L12 2M		
		NC		E2E-X8MB2L12 2M	E2E-X8MC2L12 2M		
		NO+NC		E2E-X8MB3DL12 2M	E2E-X8MC3L12 2M		
M12 Pre-wired Smartclick Connector (0.3 m)		47 mm *3		NO	E2E-X8MB1D12-M1TJ 0.3M	E2E-X8MC112-M1TJ 0.3M	
				NC	E2E-X8MB212-M1TJ 0.3M	E2E-X8MC212-M1TJ 0.3M	
				NO+NC	E2E-X8MB3D12-M1TJ 0.3M	E2E-X8MC312-M1TJ 0.3M	
		69 mm	NO	E2E-X8MB1DL12-M1TJ 0.3M	E2E-X8MC1L12-M1TJ 0.3M		
			NC	E2E-X8MB2L12-M1TJ 0.3M	E2E-X8MC2L12-M1TJ 0.3M		
			NO+NC	E2E-X8MB3DL12-M1TJ 0.3M	E2E-X8MC3L12-M1TJ 0.3M		
M12 Connector		48 mm	NO	E2E-X8MB1D12-M1	E2E-X8MC112-M1		
			NC	E2E-X8MB212-M1	E2E-X8MC212-M1		
			NO+NC	E2E-X8MB3D12-M1	E2E-X8MC312-M1		
		70 mm	NO	E2E-X8MB1DL12-M1	E2E-X8MC1L12-M1		
			NC	E2E-X8MB2L12-M1	E2E-X8MC2L12-M1		
			NO+NC	E2E-X8MB3DL12-M1	E2E-X8MC3L12-M1		

E2E/E2EQ NEXT Series DC 2-wire

E2E/E2EQ NEXT Series DC 3-wire

X55 NEXT Series

X55

X53

# E2E/E2EQ NEXT Series

## BASIC Model

Size (Sensing distance)	Connection method	Body size	Operation mode	Model	
				PNP	NPN
M18 (16 mm)	Pre-wired (2 m) *1	55 mm *2	NO	E2E-X16MB1D18 2M	E2E-X16MC118 2M
			NC	E2E-X16MB218 2M	E2E-X16MC218 2M
			NO+NC	E2E-X16MB3D18 2M	E2E-X16MC318 2M
		77 mm	NO	E2E-X16MB1DL18 2M	E2E-X16MC1L18 2M
			NC	E2E-X16MB2L18 2M	E2E-X16MC2L18 2M
			NO+NC	E2E-X16MB3DL18 2M	E2E-X16MC3L18 2M
	M12 Pre-wired Smartclick Connector (0.3 m)	55 mm *3	NO	E2E-X16MB1D18-M1TJ 0.3M	E2E-X16MC118-M1TJ 0.3M
			NC	E2E-X16MB218-M1TJ 0.3M	E2E-X16MC218-M1TJ 0.3M
			NO+NC	E2E-X16MB3D18-M1TJ 0.3M	E2E-X16MC318-M1TJ 0.3M
		77 mm	NO	E2E-X16MB1DL18-M1TJ 0.3M	E2E-X16MC1L18-M1TJ 0.3M
			NC	E2E-X16MB2L18-M1TJ 0.3M	E2E-X16MC2L18-M1TJ 0.3M
			NO+NC	E2E-X16MB3DL18-M1TJ 0.3M	E2E-X16MC3L18-M1TJ 0.3M
	M12 Connector	53 mm	NO	E2E-X16MB1D18-M1	E2E-X16MC118-M1
			NC	E2E-X16MB218-M1	E2E-X16MC218-M1
			NO+NC	E2E-X16MB3D18-M1	E2E-X16MC318-M1
		75 mm	NO	E2E-X16MB1DL18-M1	E2E-X16MC1L18-M1
			NC	E2E-X16MB2L18-M1	E2E-X16MC2L18-M1
			NO+NC	E2E-X16MB3DL18-M1	E2E-X16MC3L18-M1
M30 (30 mm)	Pre-wired (2 m) *1	82 mm *2	NO	E2E-X30MB1DL30 2M	E2E-X30MC1L30 2M
			NC	E2E-X30MB2L30 2M	E2E-X30MC2L30 2M
			NO+NC	E2E-X30MB3DL30 2M	E2E-X30MC3L30 2M
	M12 Pre-wired Smartclick Connector (0.3 m)	82 mm *3	NO	E2E-X30MB1DL30-M1TJ 0.3M	E2E-X30MC1L30-M1TJ 0.3M
			NC	E2E-X30MB2L30-M1TJ 0.3M	E2E-X30MC2L30-M1TJ 0.3M
			NO+NC	E2E-X30MB3DL30-M1TJ 0.3M	E2E-X30MC3L30-M1TJ 0.3M
	M12 Connector	80 mm	NO	E2E-X30MB1DL30-M1	E2E-X30MC1L30-M1
			NC	E2E-X30MB2L30-M1	E2E-X30MC2L30-M1
			NO+NC	E2E-X30MB3DL30-M1	E2E-X30MC3L30-M1

\*1. Models with 5-m cable length are also available (Example: E2E-X8MB1D12 5M)

\*2. Models with 2-m and 5-m robot (bending-resistant) cables are also available with "-R" in the model number. (Example: E2E-X8MB1D12-R 2M/ E2E-X8MB1D12-R 5M)

\*3. Models with M12 Smartclick connector model robot (bending-resistant) cables are also available with "R" in the model number. (Example: E2E-X8MB1D12-M1TJR 0.3M)

**Note: 1.** Models in   are equipped with IO-Link (COM2). For IO-Link (COM3), select a model number with the format of "E2E-X□□□□□" (Example: E2E-X8MB1T12 2M).

Operation mode NO can be changed to NC via IO-Link communications.

**2.** IO-Link is not supported for NC-type PNP outputs or all types of NPN outputs.

BASIC Model

E2E NEXT Series (Single distance model)

DC 3-wire [Refer to Dimensions on page 85.]

Shielded

Size (Sensing distance)	Connection method	Body size	Operation mode	Model			
				PNP	NPN		
M8 (1.5 mm)	Pre-wired (2 m) *1	38 mm *2	NO	E2E-X1R5B1D8 2M	E2E-X1R5C18 2M		
			NC	E2E-X1R5B28 2M	E2E-X1R5C28 2M		
		48 mm	NO	E2E-X1R5B1DL8 2M	E2E-X1R5C1L8 2M		
			NC	E2E-X1R5B2L8 2M	E2E-X1R5C2L8 2M		
		M12 Pre-wired Smartclick Connector (0.3 m)	38 mm *3	NO	E2E-X1R5B1D8-M1TJ 0.3M	E2E-X1R5C18-M1TJ 0.3M	
				NC	E2E-X1R5B28-M1TJ 0.3M	E2E-X1R5C28-M1TJ 0.3M	
	48 mm		NO	E2E-X1R5B1DL8-M1TJ 0.3M	E2E-X1R5C1L8-M1TJ 0.3M		
			NC	E2E-X1R5B2L8-M1TJ 0.3M	E2E-X1R5C2L8-M1TJ 0.3M		
	M12 Connector		43 mm	NO	E2E-X1R5B1D8-M1	E2E-X1R5C18-M1	
				NC	E2E-X1R5B28-M1	E2E-X1R5C28-M1	
		53 mm	NO	E2E-X1R5B1DL8-M1	E2E-X1R5C1L8-M1		
			NC	E2E-X1R5B2L8-M1	E2E-X1R5C2L8-M1		
			NO+NC	E2E-X1R5B3DL8-M1	E2E-X1R5C3L8-M1		
	M8 Connector (4-pin)	39 mm	NO	E2E-X1R5B1D8-M3	E2E-X1R5C18-M3		
			NC	E2E-X1R5B28-M3	E2E-X1R5C28-M3		
		49 mm	NO	E2E-X1R5B1DL8-M3	E2E-X1R5C1L8-M3		
			NC	E2E-X1R5B2L8-M3	E2E-X1R5C2L8-M3		
		M8 Connector (3-pin)	39 mm	NO	E2E-X1R5B1D8-M5	E2E-X1R5C18-M5	
				NC	E2E-X1R5B28-M5	E2E-X1R5C28-M5	
	49 mm		NO	E2E-X1R5B1DL8-M5	E2E-X1R5C1L8-M5		
			NC	E2E-X1R5B2L8-M5	E2E-X1R5C2L8-M5		
	M12 (2 mm)		Pre-wired (2 m) *1	47 mm *2	NO	E2E-X2B1D12 2M	E2E-X2C112 2M
					NC	E2E-X2B212 2M	E2E-X2C212 2M
NO+NC		E2E-X2B3D12 2M			E2E-X2C312 2M		
69 mm		NO		E2E-X2B1DL12 2M	E2E-X2C1L12 2M		
		NC		E2E-X2B2L12 2M	E2E-X2C2L12 2M		
		NO+NC		E2E-X2B3DL12 2M	E2E-X2C3L12 2M		
M12 Pre-wired Smartclick Connector (0.3 m)		47 mm *3		NO	E2E-X2B1D12-M1TJ 0.3M	E2E-X2C112-M1TJ 0.3M	
				NC	E2E-X2B212-M1TJ 0.3M	E2E-X2C212-M1TJ 0.3M	
				NO+NC	E2E-X2B3D12-M1TJ 0.3M	E2E-X2C312-M1TJ 0.3M	
		69 mm	NO	E2E-X2B1DL12-M1TJ 0.3M	E2E-X2C1L12-M1TJ 0.3M		
			NC	E2E-X2B2L12-M1TJ 0.3M	E2E-X2C2L12-M1TJ 0.3M		
			NO+NC	E2E-X2B3DL12-M1TJ 0.3M	E2E-X2C3L12-M1TJ 0.3M		
		M12 Connector	48 mm	NO	E2E-X2B1D12-M1	E2E-X2C112-M1	
				NC	E2E-X2B212-M1	E2E-X2C212-M1	
				NO+NC	E2E-X2B3D12-M1	E2E-X2C312-M1	
70 mm			NO	E2E-X2B1DL12-M1	E2E-X2C1L12-M1		
			NC	E2E-X2B2L12-M1	E2E-X2C2L12-M1		
			NO+NC	E2E-X2B3DL12-M1	E2E-X2C3L12-M1		

E2E/E2EQ NEXT Series DC 2-wire

E2E/E2EQ NEXT Series DC 3-wire

XSS5 NEXT Series

XSS5

XSS3

# E2E/E2EQ NEXT Series

## BASIC Model

Size (Sensing distance)	Connection method	Body size	Operation mode	Model	
				PNP	NPN
M18 (5 mm)	Pre-wired (2 m) *1	55 mm *2	NO	E2E-X5B1D18 2M	E2E-X5C118 2M
			NC	E2E-X5B218 2M	E2E-X5C218 2M
			NO+NC	E2E-X5B3D18 2M	E2E-X5C318 2M
		77 mm	NO	E2E-X5B1DL18 2M	E2E-X5C1L18 2M
			NC	E2E-X5B2L18 2M	E2E-X5C2L18 2M
			NO+NC	E2E-X5B3DL18 2M	E2E-X5C3L18 2M
	M12 Pre-wired Smartclick Connector (0.3 m)	55 mm *3	NO	E2E-X5B1D18-M1TJ 0.3M	E2E-X5C118-M1TJ 0.3M
			NC	E2E-X5B218-M1TJ 0.3M	E2E-X5C218-M1TJ 0.3M
			NO+NC	E2E-X5B3D18-M1TJ 0.3M	E2E-X5C318-M1TJ 0.3M
		77 mm	NO	E2E-X5B1DL18-M1TJ 0.3M	E2E-X5C1L18-M1TJ 0.3M
			NC	E2E-X5B2L18-M1TJ 0.3M	E2E-X5C2L18-M1TJ 0.3M
			NO+NC	E2E-X5B3DL18-M1TJ 0.3M	E2E-X5C3L18-M1TJ 0.3M
	M12 Connector	53 mm	NO	E2E-X5B1D18-M1	E2E-X5C118-M1
			NC	E2E-X5B218-M1	E2E-X5C218-M1
			NO+NC	E2E-X5B3D18-M1	E2E-X5C318-M1
		75 mm	NO	E2E-X5B1DL18-M1	E2E-X5C1L18-M1
			NC	E2E-X5B2L18-M1	E2E-X5C2L18-M1
			NO+NC	E2E-X5B3DL18-M1	E2E-X5C3L18-M1
M30 (10 mm)	Pre-wired (2 m) *1	60 mm *2	NO	E2E-X10B1D30 2M	E2E-X10C130 2M
			NC	E2E-X10B230 2M	E2E-X10C230 2M
			NO+NC	E2E-X10B3D30 2M	E2E-X10C330 2M
		82 mm	NO	E2E-X10B1DL30 2M	E2E-X10C1L30 2M
			NC	E2E-X10B2L30 2M	E2E-X10C2L30 2M
			NO+NC	E2E-X10B3DL30 2M	E2E-X10C3L30 2M
	M12 Pre-wired Smartclick Connector (0.3 m)	60 mm *3	NO	E2E-X10B1D30-M1TJ 0.3M	E2E-X10C130-M1TJ 0.3M
			NC	E2E-X10B230-M1TJ 0.3M	E2E-X10C230-M1TJ 0.3M
			NO+NC	E2E-X10B3D30-M1TJ 0.3M	E2E-X10C330-M1TJ 0.3M
		82 mm	NO	E2E-X10B1DL30-M1TJ 0.3M	E2E-X10C1L30-M1TJ 0.3M
			NC	E2E-X10B2L30-M1TJ 0.3M	E2E-X10C2L30-M1TJ 0.3M
			NO+NC	E2E-X10B3DL30-M1TJ 0.3M	E2E-X10C3L30-M1TJ 0.3M
	M12 Connector	58 mm	NO	E2E-X10B1D30-M1	E2E-X10C130-M1
			NC	E2E-X10B230-M1	E2E-X10C230-M1
			NO+NC	E2E-X10B3D30-M1	E2E-X10C330-M1
		80 mm	NO	E2E-X10B1DL30-M1	E2E-X10C1L30-M1
			NC	E2E-X10B2L30-M1	E2E-X10C2L30-M1
			NO+NC	E2E-X10B3DL30-M1	E2E-X10C3L30-M1

\*1. Models with 5-m cable length are also available (Example: E2E-X2B1D12 5M)

\*2. Models with 2-m and 5-m robot (bending-resistant) cables are also available with "-R" in the model number. (Example: E2E-X2B1D12-R 2M/ E2E-X2B1D12-R 5M)

\*3. Models with M12 Smartclick connector model robot (bending-resistant) cables are also available with "R" in the model number. (Example: E2E-X2B1D12-M1TJR 0.3M)

**Note:** 1. Models in   are equipped with IO-Link (COM2). For IO-Link (COM3), select a model number with the format of "E2E-X    " (Example: E2E-X2B1T12 2M).

Operation mode NO can be changed to NC via IO-Link communications.

2. IO-Link is not supported for NC-type PNP outputs or all types of NPN outputs.

BASIC Model

E2E NEXT Series (Single distance model)

DC 3-wire [Refer to Dimensions on page 85.]

Unshielded

Size (Sensing distance)	Connection method	Body size	Operation mode	Model		
				PNP	NPN	
M8 (2mm)	Pre-wired (2 m) *1	38 mm *2	NO	E2E-X2MB1D8 2M	E2E-X2MC18 2M	
			NC	E2E-X2MB28 2M	E2E-X2MC28 2M	
		48 mm	NO	E2E-X2MB1DL8 2M	E2E-X2MC1L8 2M	
			NC	E2E-X2MB2L8 2M	E2E-X2MC2L8 2M	
	M12 Pre-wired Smartclick Connector (0.3 m)	38 mm *3	NO	E2E-X2MB1D8-M1TJ 0.3M	E2E-X2MC18-M1TJ 0.3M	
			NC	E2E-X2MB28-M1TJ 0.3M	E2E-X2MC28-M1TJ 0.3M	
		48 mm	NO	E2E-X2MB1DL8-M1TJ 0.3M	E2E-X2MC1L8-M1TJ 0.3M	
			NC	E2E-X2MB2L8-M1TJ 0.3M	E2E-X2MC2L8-M1TJ 0.3M	
	M12 Connector	43 mm	NO	E2E-X2MB1D8-M1	E2E-X2MC18-M1	
			NC	E2E-X2MB28-M1	E2E-X2MC28-M1	
		53 mm	NO	E2E-X2MB1DL8-M1	E2E-X2MC1L8-M1	
			NC	E2E-X2MB2L8-M1	E2E-X2MC2L8-M1	
	M8 Connector (4-pin)	39 mm	NO	E2E-X2MB1D8-M3	E2E-X2MC18-M3	
			NC	E2E-X2MB28-M3	E2E-X2MC28-M3	
		49 mm	NO	E2E-X2MB1DL8-M3	E2E-X2MC1L8-M3	
			NC	E2E-X2MB2L8-M3	E2E-X2MC2L8-M3	
	M8 Connector (3-pin)	39 mm	NO	E2E-X2MB1D8-M5	E2E-X2MC18-M5	
			NC	E2E-X2MB28-M5	E2E-X2MC28-M5	
		49 mm	NO	E2E-X2MB1DL8-M5	E2E-X2MC1L8-M5	
			NC	E2E-X2MB2L8-M5	E2E-X2MC2L8-M5	
	M12 (5mm)	Pre-wired (2 m) *1	47 mm *2	NO	E2E-X5MB1D12 2M	E2E-X5MC112 2M
				NC	E2E-X5MB212 2M	E2E-X5MC212 2M
				NO+NC	E2E-X5MB3D12 2M	E2E-X5MC312 2M
			69 mm	NO	E2E-X5MB1DL12 2M	E2E-X5MC1L12 2M
NC				E2E-X5MB2L12 2M	E2E-X5MC2L12 2M	
NO+NC				E2E-X5MB3DL12 2M	E2E-X5MC3L12 2M	
M12 Pre-wired Smartclick Connector (0.3 m)		47 mm *3	NO	E2E-X5MB1D12-M1TJ 0.3M	E2E-X5MC112-M1TJ 0.3M	
			NC	E2E-X5MB212-M1TJ 0.3M	E2E-X5MC212-M1TJ 0.3M	
			NO+NC	E2E-X5MB3D12-M1TJ 0.3M	E2E-X5MC312-M1TJ 0.3M	
		69 mm	NO	E2E-X5MB1DL12-M1TJ 0.3M	E2E-X5MC1L12-M1TJ 0.3M	
			NC	E2E-X5MB2L12-M1TJ 0.3M	E2E-X5MC2L12-M1TJ 0.3M	
			NO+NC	E2E-X5MB3DL12-M1TJ 0.3M	E2E-X5MC3L12-M1TJ 0.3M	
M12 Connector		48 mm	NO	E2E-X5MB1D12-M1	E2E-X5MC112-M1	
			NC	E2E-X5MB212-M1	E2E-X5MC212-M1	
			NO+NC	E2E-X5MB3D12-M1	E2E-X5MC312-M1	
		70 mm	NO	E2E-X5MB1DL12-M1	E2E-X5MC1L12-M1	
			NC	E2E-X5MB2L12-M1	E2E-X5MC2L12-M1	
			NO+NC	E2E-X5MB3DL12-M1	E2E-X5MC3L12-M1	

E2E/E2EQ NEXT Series DC 2-wire

E2E/E2EQ NEXT Series DC 3-wire

X55 NEXT Series

X55

X53



# E2E/E2EQ NEXT Series

## BASIC Model

Size (Sensing distance)	Connection method	Body size	Operation mode	Model	
				PNP	NPN
M18 (10mm)	Pre-wired (2 m) *1	55 mm *2	NO	E2E-X10MB1D18 2M	E2E-X10MC118 2M
			NC	E2E-X10MB218 2M	E2E-X10MC218 2M
			NO+NC	E2E-X10MB3D18 2M	E2E-X10MC318 2M
		77 mm	NO	E2E-X10MB1DL18 2M	E2E-X10MC1L18 2M
			NC	E2E-X10MB2L18 2M	E2E-X10MC2L18 2M
			NO+NC	E2E-X10MB3DL18 2M	E2E-X10MC3L18 2M
	M12 Pre-wired Smartclick Connector (0.3 m)	55 mm *3	NO	E2E-X10MB1D18-M1TJ 0.3M	E2E-X10MC118-M1TJ 0.3M
			NC	E2E-X10MB218-M1TJ 0.3M	E2E-X10MC218-M1TJ 0.3M
			NO+NC	E2E-X10MB3D18-M1TJ 0.3M	E2E-X10MC318-M1TJ 0.3M
		77 mm	NO	E2E-X10MB1DL18-M1TJ 0.3M	E2E-X10MC1L18-M1TJ 0.3M
			NC	E2E-X10MB2L18-M1TJ 0.3M	E2E-X10MC2L18-M1TJ 0.3M
			NO+NC	E2E-X10MB3DL18-M1TJ 0.3M	E2E-X10MC3L18-M1TJ 0.3M
	M12 Connector	53 mm	NO	E2E-X10MB1D18-M1	E2E-X10MC118-M1
			NC	E2E-X10MB218-M1	E2E-X10MC218-M1
			NO+NC	E2E-X10MB3D18-M1	E2E-X10MC318-M1
		75 mm	NO	E2E-X10MB1DL18-M1	E2E-X10MC1L18-M1
			NC	E2E-X10MB2L18-M1	E2E-X10MC2L18-M1
			NO+NC	E2E-X10MB3DL18-M1	E2E-X10MC3L18-M1
M30 (18mm)	Pre-wired (2 m) *1	60 mm *2	NO	E2E-X18MB1D30 2M	E2E-X18MC130 2M
			NC	E2E-X18MB230 2M	E2E-X18MC230 2M
			NO+NC	E2E-X18MB3D30 2M	E2E-X18MC330 2M
		82 mm	NO	E2E-X18MB1DL30 2M	E2E-X18MC1L30 2M
			NC	E2E-X18MB2L30 2M	E2E-X18MC2L30 2M
			NO+NC	E2E-X18MB3DL30 2M	E2E-X18MC3L30 2M
	M12 Pre-wired Smartclick Connector (0.3 m)	60 mm *3	NO	E2E-X18MB1D30-M1TJ 0.3M	E2E-X18MC130-M1TJ 0.3M
			NC	E2E-X18MB230-M1TJ 0.3M	E2E-X18MC230-M1TJ 0.3M
			NO+NC	E2E-X18MB3D30-M1TJ 0.3M	E2E-X18MC330-M1TJ 0.3M
		82 mm	NO	E2E-X18MB1DL30-M1TJ 0.3M	E2E-X18MC1L30-M1TJ 0.3M
			NC	E2E-X18MB2L30-M1TJ 0.3M	E2E-X18MC2L30-M1TJ 0.3M
			NO+NC	E2E-X18MB3DL30-M1TJ 0.3M	E2E-X18MC3L30-M1TJ 0.3M
	M12 Connector	58 mm	NO	E2E-X18MB1D30-M1	E2E-X18MC130-M1
			NC	E2E-X18MB230-M1	E2E-X18MC230-M1
			NO+NC	E2E-X18MB3D30-M1	E2E-X18MC330-M1
		80 mm	NO	E2E-X18MB1DL30-M1	E2E-X18MC1L30-M1
			NC	E2E-X18MB2L30-M1	E2E-X18MC2L30-M1
			NO+NC	E2E-X18MB3DL30-M1	E2E-X18MC3L30-M1

\*1. Models with 5-m cable length are also available (Example: E2E-X5MB1D12 5M)

\*2. Models with 2-m and 5-m robot (bending-resistant) cables are also available with "-R" in the model number. (Example: E2E-X5MB1D12-R 2M/ E2E-X5MB1D12-R 5M)

\*3. Models with M12 Smartclick connector model robot (bending-resistant) cables are also available with "R" in the model number. (Example: E2E-X5MB1D12-M1TJR 2M)

**Note:** 1. Models in   are equipped with IO-Link (COM2). For IO-Link (COM3), select a model number with the format of "E2E-X    " (Example: E2E-X5MB1T12 2M).

Operation mode NO can be changed to NC via IO-Link communications.

2. IO-Link is not supported for NC-type PNP outputs or all types of NPN outputs.

BASIC Model

E2EQ NEXT Series (Spatter-resistant Double distance model)

DC 3-wire [Refer to Dimensions on page 85.]

Shielded

Size (Sensing distance)	Connection method	Body size	Operation mode	Model		
				PNP	NPN	
M8 (2 mm)	Pre-wired (2 m) *	38 mm	NO	E2EQ-X2B1D8 2M	E2EQ-X2C18 2M	
			NC	E2EQ-X2B28 2M	E2EQ-X2C28 2M	
			NO+NC	E2EQ-X2B1D8-M1TJ 0.3M	E2EQ-X2C18-M1TJ 0.3M	
	M12 Pre-wired Smartclick Connector (0.3 m)	38 mm	NO	E2EQ-X2B28-M1TJ 0.3M	E2EQ-X2C28-M1TJ 0.3M	
			NC	E2EQ-X2B1D8-M1	E2EQ-X2C18-M1	
			NO+NC	E2EQ-X2B28-M1	E2EQ-X2C28-M1	
M12 Connector	43 mm	NO	E2EQ-X4B1D12 2M	E2EQ-X4C112 2M		
		NC	E2EQ-X4B212 2M	E2EQ-X4C212 2M		
		NO+NC	E2EQ-X4B3D12 2M	E2EQ-X4C312 2M		
M12 (4 mm)	Pre-wired (2 m) *	47 mm	NO	E2EQ-X4B1D12-M1TJ 0.3M	E2EQ-X4C112-M1TJ 0.3M	
			NC	E2EQ-X4B212-M1TJ 0.3M	E2EQ-X4C212-M1TJ 0.3M	
			NO+NC	E2EQ-X4B3D12-M1TJ 0.3M	E2EQ-X4C312-M1TJ 0.3M	
		M12 Pre-wired Smartclick Connector (0.3 m)	47 mm	NO	E2EQ-X4B1D12-M1	E2EQ-X4C112-M1
				NC	E2EQ-X4B212-M1	E2EQ-X4C212-M1
				NO+NC	E2EQ-X4B3D12-M1	E2EQ-X4C312-M1
	M12 Connector	48 mm	NO	E2EQ-X8B1D18 2M	E2EQ-X8C118 2M	
			NC	E2EQ-X8B218 2M	E2EQ-X8C218 2M	
			NO+NC	E2EQ-X8B3D18 2M	E2EQ-X8C318 2M	
M18 (8 mm)	Pre-wired (2 m) *	55 mm	NO	E2EQ-X8B1D18-M1TJ 0.3M	E2EQ-X8C118-M1TJ 0.3M	
			NC	E2EQ-X8B218-M1TJ 0.3M	E2EQ-X8C218-M1TJ 0.3M	
			NO+NC	E2EQ-X8B3D18-M1TJ 0.3M	E2EQ-X8C318-M1TJ 0.3M	
		M12 Pre-wired Smartclick Connector (0.3 m)	55 mm	NO	E2EQ-X8B1D18-M1	E2EQ-X8C118-M1
				NC	E2EQ-X8B218-M1	E2EQ-X8C218-M1
				NO+NC	E2EQ-X8B3D18-M1	E2EQ-X8C318-M1
	M12 Connector	53 mm	NO	E2EQ-X15B1D30 2M	E2EQ-X15C130 2M	
			NC	E2EQ-X15B230 2M	E2EQ-X15C230 2M	
			NO+NC	E2EQ-X15B3D30 2M	E2EQ-X15C330 2M	
M30 (15 mm)	Pre-wired (2 m) *	60 mm	NO	E2EQ-X15B1D30-M1TJ 0.3M	E2EQ-X15C130-M1TJ 0.3M	
			NC	E2EQ-X15B230-M1TJ 0.3M	E2EQ-X15C230-M1TJ 0.3M	
			NO+NC	E2EQ-X15B3D30-M1TJ 0.3M	E2EQ-X15C330-M1TJ 0.3M	
		M12 Pre-wired Smartclick Connector (0.3 m)	60 mm	NO	E2EQ-X15B1D30-M1	E2EQ-X15C130-M1
				NC	E2EQ-X15B230-M1	E2EQ-X15C230-M1
				NO+NC	E2EQ-X15B3D30-M1	E2EQ-X15C330-M1
	M12 Connector	58 mm	NO	E2EQ-X15B1D30-M1	E2EQ-X15C130-M1	
			NC	E2EQ-X15B230-M1	E2EQ-X15C230-M1	
			NO+NC	E2EQ-X15B3D30-M1	E2EQ-X15C330-M1	

\* Models with 5-m cable length are also available (Example: E2EQ-X6B1D12 5M)

**Note:** 1. Models in [ ] are equipped with IO-Link (COM2). For IO-Link (COM3), select a model number with the format of "E2E-X□□□T□" (Example: E2EQ-X6B1T12 2M).

Operation mode NO can be changed to NC via IO-Link communications.

2. IO-Link is not supported for NC-type PNP outputs or all types of NPN outputs.

# E2E/E2EQ NEXT Series

## BASIC Model

### E2EQ NEXT Series (Spatter-resistant Single distance model)

DC 3-wire [Refer to *Dimensions* on page 85.]

Shielded

Size (Sensing distance)	Connection method	Body size	Operation mode	Model	
				PNP	NPN
M8 (1.5 mm)	Pre-wired (2 m) *	38 mm	NO	E2EQ-X1R5B1D8 2M	E2EQ-X1R5C18 2M
			NC	E2EQ-X1R5B28 2M	E2EQ-X1R5C28 2M
	M12 Pre-wired Smartclick Connector (0.3 m)	38 mm	NO	E2EQ-X1R5B1D8-M1TJ 0.3M	E2EQ-X1R5C18-M1TJ 0.3M
			NC	E2EQ-X1R5B28-M1TJ 0.3M	E2EQ-X1R5C28-M1TJ 0.3M
	M12 Connector	43 mm	NO	E2EQ-X1R5B1D8-M1	E2EQ-X1R5C18-M1
			NC	E2EQ-X1R5B28-M1	E2EQ-X1R5C28-M1
M12 (2 mm)	Pre-wired (2 m) *	47 mm	NO	E2EQ-X2B1D12 2M	E2EQ-X2C112 2M
			NC	E2EQ-X2B212 2M	E2EQ-X2C212 2M
			NO+NC	E2EQ-X2B3D12 2M	E2EQ-X2C312 2M
	M12 Pre-wired Smartclick Connector (0.3 m)	47 mm	NO	E2EQ-X2B1D12-M1TJ 0.3M	E2EQ-X2C112-M1TJ 0.3M
			NC	E2EQ-X2B212-M1TJ 0.3M	E2EQ-X2C212-M1TJ 0.3M
			NO+NC	E2EQ-X2B3D12-M1TJ 0.3M	E2EQ-X2C312-M1TJ 0.3M
	M12 Connector	48 mm	NO	E2EQ-X2B1D12-M1	E2EQ-X2C112-M1
			NC	E2EQ-X2B212-M1	E2EQ-X2C212-M1
			NO+NC	E2EQ-X2B3D12-M1	E2EQ-X2C312-M1
M18 (5 mm)	Pre-wired (2 m) *	55 mm	NO	E2EQ-X5B1D18 2M	E2EQ-X5C118 2M
			NC	E2EQ-X5B218 2M	E2EQ-X5C218 2M
			NO+NC	E2EQ-X5B3D18 2M	E2EQ-X5C318 2M
	M12 Pre-wired Smartclick Connector (0.3 m)	55 mm	NO	E2EQ-X5B1D18-M1TJ 0.3M	E2EQ-X5C118-M1TJ 0.3M
			NC	E2EQ-X5B218-M1TJ 0.3M	E2EQ-X5C218-M1TJ 0.3M
			NO+NC	E2EQ-X5B3D18-M1TJ 0.3M	E2EQ-X5C318-M1TJ 0.3M
	M12 Connector	53 mm	NO	E2EQ-X5B1D18-M1	E2EQ-X5C118-M1
			NC	E2EQ-X5B218-M1	E2EQ-X5C218-M1
			NO+NC	E2EQ-X5B3D18-M1	E2EQ-X5C318-M1
M30 (10 mm)	Pre-wired (2 m) *	60 mm	NO	E2EQ-X10B1D30 2M	E2EQ-X10C130 2M
			NC	E2EQ-X10B230 2M	E2EQ-X10C230 2M
			NO+NC	E2EQ-X10B3D30 2M	E2EQ-X10C330 2M
	M12 Pre-wired Smartclick Connector (0.3 m)	60 mm	NO	E2EQ-X10B1D30-M1TJ 0.3M	E2EQ-X10C130-M1TJ 0.3M
			NC	E2EQ-X10B230-M1TJ 0.3M	E2EQ-X10C230-M1TJ 0.3M
			NO+NC	E2EQ-X10B3D30-M1TJ 0.3M	E2EQ-X10C330-M1TJ 0.3M
	M12 Connector	58 mm	NO	E2EQ-X10B1D30-M1	E2EQ-X10C130-M1
			NC	E2EQ-X10B230-M1	E2EQ-X10C230-M1
			NO+NC	E2EQ-X10B3D30-M1	E2EQ-X10C330-M1

\* Models with 5-m cable length are also available (Example: E2EQ-X6B1D12 5M)

**Note:** 1. Models in   are equipped with IO-Link (COM2). For IO-Link (COM3), select a model number with the format of "E2E-X     " (Example: E2EQ-X6B1T12 2M).

Operation mode NO can be changed to NC via IO-Link communications.

2. IO-Link is not supported for NC-type PNP outputs or all types of NPN outputs.

**Accessories (Sold Separately)**

**Sensor I/O Connectors**



(Models for Pre-wired Connectors) A Sensor I/O Connector is not provided with the Sensor. It must be ordered separately as required.

**Round Oil-resistant Connectors XS5 NEXT series**

Appearance	Cable specification	Type	Cable diameter (mm)	Cable connection direction	Cable length (m)	Sensor I/O Connector model number	Applicable Proximity Sensor model number
M12 Smartclick Connector Models Straight type 	Oil-resistant PVC cable	Sockets on One Cable End	6 dia.	Straight	1	XS5F-D421-C80-X	E2E-X□□□-M1TJ(R) E2EQ-X□□□-M1TJ E2E(Q)-X□□□-M1
					2	XS5F-D421-D80-X	
					3	XS5F-D421-E80-X	
					5	XS5F-D421-G80-X	
					10	XS5F-D421-J80-X	
	Oil-resistant PVC robot cable	Sockets on One Cable End	6 dia.	Straight	1	XS5F-D421-C80-XR	
					2	XS5F-D421-D80-XR	
					3	XS5F-D421-E80-XR	
					5	XS5F-D421-G80-XR	
					10	XS5F-D421-J80-XR	
	Oil-resistant PVC cable	Socket and Plug on Cable Ends	6 dia.	Straight (Socket)/ Straight (Plug)	1	XS5W-D421-C81-X	
					2	XS5W-D421-D81-X	
					3	XS5W-D421-E81-X	
					5	XS5W-D421-G81-X	
					10	XS5W-D421-J81-X	
	Oil-resistant PVC robot cable	Socket and Plug on Cable Ends	6 dia.	Straight (Socket)/ Straight (Plug)	1	XS5W-D421-C81-XR	
					2	XS5W-D421-D81-XR	
					3	XS5W-D421-E81-XR	
5					XS5W-D421-G81-XR		
10					XS5W-D421-J81-XR		

**Note:** For details of the connector, refer to *XS5 NEXT Series* on page 87.

**Round Water-resistant Connectors XS5 series**

Appearance	Cable Specification	Type	Cable diameter (mm)	Cable Connection Direction	Cable length (m)	Sensor I/O Connector model number	Applicable Proximity Sensor model number	
M12 Smartclick Connector Straight type  Right-angle type 	PVC robot cable	Sockets on One Cable End	6 dia.	Straight	1	XS5F-D421-C80-F	E2E-X□□□-M1TJ(R) E2EQ-X□□□-M1TJ E2E(Q)-X□□□-M1	
					2	XS5F-D421-D80-F		
					3	XS5F-D421-E80-F		
					5	XS5F-D421-G80-F		
					10	XS5F-D421-J80-F		
				Right-angle	1	XS5F-D422-C80-F		
					2	XS5F-D422-D80-F		
					3	XS5F-D422-E80-F		
					5	XS5F-D422-G80-F		
					10	XS5F-D422-J80-F		
		Socket and Plug on Cable Ends	6 dia.		Straight (Socket)/ Straight (Plug)	1		XS5W-D421-C81-F
						2		XS5W-D421-D81-F
						3		XS5W-D421-E81-F
				5		XS5W-D421-G81-F		
				10		XS5W-D421-J81-F		
		Right-angle (Socket)/ Right-angle (Plug)	6 dia.	Right-angle (Socket)/ Right-angle (Plug)	2	XS5W-D422-D81-F		
					5	XS5W-D422-G81-F		
					Straight (Socket)/ Right-angle (Plug)	2		XS5W-D423-D81-F
5	XS5W-D423-G81-F							
Right-angle (Socket)/ Straight (Plug)	6 dia.				Right-angle (Socket)/ Straight (Plug)	2	XS5W-D424-D81-F	
		5	XS5W-D424-G81-F					

**Note:** For details of the connector, refer to *XS5 Series* on page 94.

E2E/E2EQ NEXT Series DC 2-wire

E2E/E2EQ NEXT Series DC 3-wire



XS5 NEXT Series

XS5

XS3

# E2E/E2EQ NEXT Series

## Round Water-resistant Connectors XS3W-M8/XS3F-M8 series

Appearance	Cable specification	Type	Cable diameter (mm)	No. of cable cores (Poles)	Cable connection direction	Cable length (m)	Sensor I/O Connector model number	Applicable Proximity Sensor model number
M8 Connector Straight type 	PVC cable	Sockets on One Cable End	5 dia.	3	Straight	2	XS3F-M8PVC3S2M	E2E-X□□□-M5
						5	XS3F-M8PVC3S5M	
						10	XS3F-M8PVC3S10M	
					Right-angle	2	XS3F-M8PVC3A2M	
						5	XS3F-M8PVC3A5M	
						10	XS3F-M8PVC3A10M	
		4		Straight	2	XS3F-M8PVC4S2M	E2E-X□□□-M3	
					5	XS3F-M8PVC4S5M		
					10	XS3F-M8PVC4S10M		
				Right-angle	2	XS3F-M8PVC4A2M		
					5	XS3F-M8PVC4A5M		
					10	XS3F-M8PVC4A10M		
Right-angle type 	PVC cable	Socket and Plug on Cable Ends	5 dia.	3	Straight (Plug)/ Straight (Socket)	2	XS3W-M8PVC3SS2M	E2E-X□□□-M5
						5	XS3W-M8PVC3SS5M	
						10	XS3W-M8PVC3SS10M	
					Straight (Plug)/ Right-angle (Socket)	2	XS3W-M8PVC3SA2M	
						5	XS3W-M8PVC3SA5M	
						10	XS3W-M8PVC3SA10M	
		4		Straight (Plug)/ Straight (Socket)	2	XS3W-M8PVC4SS2M	E2E-X□□□-M3	
					5	XS3W-M8PVC4SS5M		
					10	XS3W-M8PVC4SS10M		
				Straight (Plug)/ Right-angle (Socket)	2	XS3W-M8PVC4SA2M		
					5	XS3W-M8PVC4SA5M		
					10	XS3W-M8PVC4SA10M		

**Note:** For details of the connector, refer to *XS3W-M8/XS3F-M8 Series* on page 102.

## Sensor I/O Connectors Oil resistance performance of mating combination

E2E NEXT Series		Applicable connector Model		
Connecting method	Model	XS5 NEXT Series	XS5 Series	XS3W-M8/XS3F-M8 Series
Pre-wired Connector Models	E2E-X□□-M1TJ(R)	Oil resistant (2 years) *	Water-resistant (IP67)	---
M12 Connector Models	E2E-X□□-M1	Water-resistant (IP67)	Water-resistant (IP67)	---
M8 Connector (4-pin) Models	E2E-X□□-M3	---	---	Water-resistant (IP67)
M8 Connector (3-pin) Models	E2E-X□□-M5	---	---	Water-resistant (IP67)

\* Applicable cutting oil type: specified in JIS K 2241:2000

2 years of oil resistance indicates the median value of the product design and the oil-resistance performance criterion result (=Typical value). Products to be shipped will have around 2 years of oil resistance, but will vary depending on the product.

## e-jig (Mounting Sleeves) [Refer to Dimensions on page 86.]

**A Mounting Bracket is not provided with the Sensor. It must be ordered separately as required.**

Only applicable to standard body-sized E2E NEXT Series Sensors.

Appearance	Model	Applicable Sensors
	Y92E-J8S12	E2E NEXT M8 Shielded Sensors
	Y92E-J12S18	E2E NEXT M12 Shielded Sensors
	Y92E-J18S30	E2E NEXT M18 Shielded Sensors

**Note:** Not applicable for E2E NEXT Series long-body models and E2EQ NEXT Series (spatter-resistant) models.

## Ratings and Specifications

## PREMIUM Model

E2E NEXT Series (Quadruple/Triple distance model)  
DC 3-wire  
Shielded

Types Size Model	Quadruple distance model				Triple distance model				
	M8	M12	M18	M30	M8	M12	M18	M30	
Item	E2E-X4□8	E2E-X9□12	E2E-X14□18	E2E-X23□30	E2E-X3□8	E2E-X6□12	E2E-X12□18	E2E-X22□30	
Sensing distance	4 mm±10%	9 mm±10%	14 mm±10%	23 mm±10%	3 mm±10%	6 mm±10%	12 mm±10%	22 mm±10%	
Setting distance	0 to 3 mm	0 to 6.8 mm	0 to 10.6 mm	0 to 17.6 mm	0 to 2.4 mm	0 to 4.8 mm	0 to 9.6 mm	0 to 16.8 mm	
Differential travel	15% max. of sensing distance								
Detectable object	Ferrous metals (For non-ferrous metals, refer to the <i>Engineering Data</i> on page 68.)								
Standard sensing object	Iron, 12 × 12 × 1 mm	Iron, 27 × 27 × 1 mm	Iron, 42 × 42 × 1 mm	Iron, 69 × 69 × 1 mm	Iron, 9 × 9 × 1 mm	Iron, 18 × 18 × 1 mm	Iron, 36 × 36 × 1 mm	Iron, 66 × 66 × 1 mm	
Response frequency *1	700 Hz	700 Hz	350 Hz	200 Hz	1,000 Hz	800 Hz	500 Hz	200 Hz	
Power supply voltage	10 to 30 VDC (including 10% ripple (p-p)), Class 2								
Current consumption	1-output models: 16 mA max.					1-output models: 16 mA max., 2-output models: 20 mA max.			
Output configuration	B□ Models: PNP open collector, C□ Models: NPN open collector								
Operation mode (with sensing object approaching)	1-output models (B1, C1): NO (Normally open), 1-output models (B2, C2): NC (Normally closed)					1-output models (B1, C1): NO (Normally open), 1-output models (B2, C2): NC (Normally closed), 2-output models (B3, C3): NO+NC (Normally open, Normally closed)			
Control output	Load current	1-output models: 10 to 30 VDC, Class 2, 50 mA max.			1-output models: 10 to 30 VDC, Class 2, 100 mA max.	1-output models: 10 to 30 VDC, Class 2, 100 mA max., 2-output models: 10 to 30 VDC, Class 2, 50 mA max.			
	Residual voltage	1-output models: 2 V max. (Load current: 50 mA, Cable length: 2 m)			1-output models: 2 V max. (Load current: 100 mA, Cable length: 2 m)	1-output models: 2 V max. (Load current: 100 mA, Cable length: 2 m), 2-output models: 2 V max. (Load current: 50 mA, Cable length: 2 m)			
Indicator *2	In the Standard I/O mode (SIO mode): Operation indicator (orange, lit) and communication indicator (green, not lit) In the IO-Link communication mode (COM mode): Operation indicator (orange, lit) and communication indicator (green, blinking at 1 s intervals)								
Protection circuits	Power supply reverse polarity protection, Surge suppressor, Output short-circuit protection, Output reverse polarity protection								
Ambient temperature range	Operating: -25 to 60°C Storage: -25 to 70°C (with no icing or condensation)	Operating/Storage: -25 to 70°C (with no icing or condensation)							
Ambient humidity range	Operating/Storage: 35% to 95% (with no condensation)								
Temperature influence	-15% to 25% max. of sensing distance at 23°C in the temperature range of -25 to 60°C	±15% max. of sensing distance at 23°C in the temperature range of -25 to 70°C			±10% max. of sensing distance at 23°C in the temperature range of -25 to 70°C				
Voltage influence	±1% max. of sensing distance at rated voltage in the rated voltage ±15% range								
Insulation resistance	50 MΩ min. (at 500 VDC) between current-carrying parts and case								
Dielectric strength	1,000 VAC, 50/60 Hz for 1 minute between current-carrying parts and case								
Vibration resistance (destruction)	10 to 55 Hz, 1.5-mm double amplitude for 2 hours each in X, Y, and Z directions								
Shock resistance (destruction)	500 m/s <sup>2</sup> 10 times each in X, Y, and Z directions	1,000 m/s <sup>2</sup> 10 times each in X, Y, and Z directions			500 m/s <sup>2</sup> 10 times each in X, Y, and Z directions	1,000 m/s <sup>2</sup> 10 times each in X, Y, and Z directions			
Degree of protection	Pre-wired Models, Pre-wired Connector Models: IEC 60529: IP67, ISO 20653 (old standard: DIN 40050 PART9): IP69K, JIS C 0920 Annex 1: IP67G, Passed OMRON's Oil-resistant Component Evaluation Standards *3 (Cutting oil type: specified in JIS K 2241: 2000; Temperature: 35°C max.) Connector Models: IEC 60529: IP67, ISO 20653 (old standard: DIN 40050 PART9): IP69K								
Connection method	Pre-wired Models (Standard cable length: 2 m), Pre-wired Connector Models (Standard cable length: 0.3 m) and Connector Models (M12 Connector, M8 (4-pin) Connector and M8 (3-pin) Connector)								
Weight *4 (packed state)	Pre-wired	Approx. 85 g	Approx. 95 g	Approx. 180 g	Approx. 260 g	Approx. 85 g	Approx. 95 g	Approx. 180 g	Approx. 260 g
	M12 Pre-wired Smartclick Connector	Approx. 55 g	Approx. 70 g	Approx. 115 g	Approx. 200 g	Approx. 55 g	Approx. 70 g	Approx. 115 g	Approx. 200 g
	Connector	Approx. 40 g *5	Approx. 55 g	Approx. 95 g	Approx. 180 g	Approx. 40 g *5	Approx. 55 g	Approx. 95 g	Approx. 180 g

# E2E/E2EQ NEXT Series

Item	Types Size	Quadruple distance model				Triple distance model			
		M8	M12	M18	M30	M8	M12	M18	M30
	Model	E2E-X4□8	E2E-X9□12	E2E-X14□18	E2E-X23□30	E2E-X3□8	E2E-X6□12	E2E-X12□18	E2E-X22□30
Materials	Case	Nickel-plated brass							
	Sensing surface	Polybutylene terephthalat (PBT)							
	Clamping nuts	Nickel-plated brass							
	Toothed washers	Zinc-plated iron							
	Cable	Vinyl chloride (PVC)							
Main IO-Link functions*2	Operation mode switching between NO and NC, self diagnosis enabling, excessive proximity judgment distance selecting, timer function of the control output and timer time selecting, instability output (IO-Link mode) ON delay timer time selecting function, monitor output, operating hours read-out, readout of the sensor internal temperature, and initial reset								
IO-Link Communication specifications*2	IO-Link specification	Ver 1.1							
	Baud rate	COM2 (38.4 kbps), COM3 (230.4 kbps)							
	Data length	PD size: 2 bytes, OD size: 1 byte (M-sequence type: TYPE_2_2)							
	Minimum cycle time	COM2: 2.3 ms, COM3: 0.4 ms							
Accessories	Instruction manual, Clamping nuts, Toothed washer								

\*1. The response frequency is an average value. Measurement conditions are as follows: standard sensing object, a distance of twice the standard sensing object, and a set distance of half the sensing distance.

\*2. IO-Link is not supported for NC-type PNP outputs or all types of NPN outputs.

\*3. The Oil-resistant Component Evaluation Standards are OMRON's own durability evaluation standards.

2-year oil resistance indicates the median value of the product design and the oil-resistance performance criterion result (=Typical value). The Pre-wired Connector Model verifies 2 years of oil resistance when mating with Round Oil-resistant Connectors XS5 NEXT series correctly. The degree of protection is not satisfied with the part where cable wires are uncovered for the Pre-wired Models.

\*4. Weight of the standard body-sized model.

\*5. Both M8 connectors and M12 connectors are available.



**PREMIUM Model**

**E2E NEXT Series (Quadruple/Triple distance model)**  
**DC 3-wire**  
**Unshielded**

Item	Types Size Model	Quadruple distance model				Triple distance model			
		M8	M12	M18	M30	M8	M12	M18	M30
		E2E-X8M□8	E2E-X16M□12	E2E-X30M□18	E2E-X50M□30	E2E-X6M□8	E2E-X10M□12	E2E-X20M□18	E2E-X40M□30
<b>Sensing distance</b>		8 mm±10%	16 mm±10%	30 mm±10%	50 mm±10%	6 mm±10%	10 mm±10%	20 mm±10%	40 mm±10%
<b>Setting distance</b>		0 to 6 mm	0 to 12.2 mm	0 to 23 mm	0 to 38.2 mm	0 to 4.8 mm	0 to 8 mm	0 to 16 mm	0 to 32 mm
<b>Differential travel</b>		15% max. of sensing distance							
<b>Detectable object</b>		Ferrous metals (For non-ferrous metals, refer to the <i>Engineering Data</i> on page 68.)							
<b>Standard sensing object</b>		Iron, 24 × 24 × 1 mm	Iron, 48 × 48 × 1 mm	Iron, 90 × 90 × 1 mm	Iron, 150 × 150 × 1 mm	Iron, 18 × 18 × 1 mm	Iron, 30 × 30 × 1 mm	Iron, 60 × 60 × 1 mm	Iron, 120 × 120 × 1 mm
<b>Response frequency *1</b>		500 Hz	400 Hz	200 Hz	100 Hz	800 Hz	400 Hz	200 Hz	100 Hz
<b>Power supply voltage</b>		10 to 30 VDC (including 10% ripple (p-p)), Class 2							
<b>Current consumption</b>		1-output models: 16 mA max.				1-output models: 16 mA max., 2-output models: 20 mA max.			
<b>Output configuration</b>		B□ Models: PNP open collector C□ Models: NPN open collector							
<b>Operation mode (with sensing object approaching)</b>		1-output models (B1, C1): NO (Normally open), 1-output models (B2, C2): NC (Normally closed)				1-output models (B1, C1): NO (Normally open), 1-output models (B2, C2): NC (Normally closed), 2-output models (B3, C3): NO+NC (Normally open, Normally closed)			
<b>Control output</b>	<b>Load current</b>	1-output models: 10 to 30 VDC, Class 2, 50 mA max.				1-output models: 10 to 30 VDC, Class 2, 100 mA max.		1-output models: 10 to 30 VDC, Class 2, 100 mA max., 2-output models: 10 to 30 VDC, Class 2, 50 mA max.	
	<b>Residual voltage</b>	1-output models: 2 V max. (Load current: 50 mA, Cable length: 2 m)				1-output models: 2 V max. (Load current: 100 mA, Cable length: 2 m)		1-output models: 2 V max. (Load current: 100 mA, Cable length: 2 m), 2-output models: 2 V max. (Load current: 50 mA, Cable length: 2 m)	
<b>Indicator *2</b>		In the Standard I/O mode (SIO mode): Operation indicator (orange, lit) and communication indicator (green, not lit) In the IO-Link communication mode (COM mode): Operation indicator (orange, lit) and communication indicator (green, blinking at 1 s intervals)							
<b>Protection circuits</b>		Power supply reverse polarity protection, Surge suppressor, Output short-circuit protection, Output reverse polarity protection							
<b>Ambient temperature range</b>		Operating/Storage: -25 to 70°C (with no icing or condensation)							
<b>Ambient humidity range</b>		Operating/Storage: 35% to 95% (with no condensation)							
<b>Temperature influence</b>		±15% max. of sensing distance at 23°C in the temperature range of -25 to 70°C				±10% max. of sensing distance at 23°C in the temperature range of -25 to 70°C			
<b>Voltage influence</b>		±1% max. of sensing distance at rated voltage in the rated voltage ±15% range							
<b>Insulation resistance</b>		50 MΩ min. (at 500 VDC) between current-carrying parts and case							
<b>Dielectric strength</b>		1,000 VAC, 50/60 Hz for 1 minute between current-carrying parts and case							
<b>Vibration resistance (destruction)</b>		10 to 55 Hz, 1.5-mm double amplitude for 2 hours each in X, Y, and Z directions							
<b>Shock resistance (destruction)</b>		500 m/s <sup>2</sup> 10 times each in X, Y, and Z directions		1,000 m/s <sup>2</sup> 10 times each in X, Y, and Z directions		500 m/s <sup>2</sup> 10 times each in X, Y, and Z directions		1,000 m/s <sup>2</sup> 10 times each in X, Y, and Z directions	
<b>Degree of protection</b>		Pre-wired Models, Pre-wired Connector Models: IEC 60529:IP67, ISO 20653 (old standard: DIN 40050 PART9): IP69K, JIS C 0920 Annex 1: IP67G, Passed OMRON's Oil-resistant Component Evaluation Standards *3 (Cutting oil type: specified in JIS K 2241: 2000; Temperature: 35°C max.) Connector Models: IEC 60529: IP67, ISO 20653 (old standard: DIN 40050 PART9): IP69K							
<b>Connection method</b>		Pre-wired Models (Standard cable length: 2 m), Pre-wired Connector Models (Standard cable length: 0.3 m) and Connector Models (M12 Connector, M8 (4-pin) Connector and M8 (3-pin) Connector)							
<b>Weight *4 (packed state)</b>	<b>Pre-wired</b>	Approx. 85 g	Approx. 95 g	Approx. 190 g	Approx. 310 g	Approx. 85 g	Approx. 95 g	Approx. 190 g	Approx. 280 g
	<b>M12 Pre-wired Smartclick Connector</b>	Approx. 55 g	Approx. 70 g	Approx. 125 g	Approx. 250 g	Approx. 55 g	Approx. 70 g	Approx. 125 g	Approx. 220 g
	<b>Connector</b>	Approx. 40 g *5	Approx. 55 g	Approx. 105 g	Approx. 230 g	Approx. 40 g *5	Approx. 55 g	Approx. 105 g	Approx. 200 g

## E2E/E2EQ NEXT Series

Types Size		Quadruple distance model				Triple distance model			
		M8	M12	M18	M30	M8	M12	M18	M30
Item	Model	E2E-X8M□8	E2E-X16M□12	E2E-X30M□18	E2E-X50M□30	E2E-X6M□8	E2E-X10M□12	E2E-X20M□18	E2E-X40M□30
Materials	Case	Stainless (SUS303)	Nickel-plated brass			Stainless (SUS303)	Nickel-plated brass		
	Sensing surface	Polybutylene terephthalat (PBT)							
	Clamping nuts	Nickel-plated brass							
	Toothed washers	Zinc-plated iron							
	Cable	Vinyl chloride (PVC)							
Main IO-Link functions*2		Operation mode switching between NO and NC, self diagnosis enabling, excessive proximity judgment distance selecting, timer function of the control output and timer time selecting, instability output (IO-Link mode) ON delay timer time selecting function, monitor output, operating hours read-out, readout of the sensor internal temperature, and initial reset							
IO-Link Communication specifications*2	IO-Link specification	Ver1.1							
	Baud rate	COM2 (38.4 kbps), COM3 (230.4 kbps)							
	Data length	PD size: 2 bytes, OD size: 1 byte (M-sequence type: TYPE_2_2)							
	Minimum cycle time	COM2: 2.3 ms, COM3: 0.4 ms							
Accessories		Instruction manual, Clamping nuts, Toothed washer							

\*1. The response frequency is an average value. Measurement conditions are as follows: standard sensing object, a distance of twice the standard sensing object, and a set distance of half the sensing distance.

\*2. IO-Link is not supported for NC-type PNP outputs or all types of NPN outputs.

\*3. The Oil-resistant Component Evaluation Standards are OMRON's own durability evaluation standards. 2-year oil resistance indicates the median value of the product design and the oil-resistance performance criterion result (=Typical value). Actual performance can be expected to decline after two years on average from shipment. The Pre-wired Connector Model verifies 2 years of oil resistance when mating with Round Oil-resistant Connectors XS5 NEXT series correctly. The degree of protection is not satisfied with the part where cable wires are uncovered for the Pre-wired Models.

\*4. Weight of the standard body-sized model.

\*5. Both M8 connectors and M12 connectors are available.

**PREMIUM Model**

**E2EQ NEXT Series (Spatter-resistant Triple distance model)**  
**DC 3-wire**  
**Shielded**

Item	Types Size Model	Triple distance Models			
		M8	M12	M18	M30
		E2EQ-X3□8	E2EQ-X6□12	E2EQ-X12□18	E2EQ-X22□30
Sensing distance		3 mm±10%	6 mm±10%	12 mm±10%	22 mm±10%
Setting distance		0 to 2.4 mm	0 to 4.8 mm	0 to 9.6 mm	0 to 16.8 mm
Differential travel		15% max. of sensing distance			
Detectable object		Ferrous metals (For non-ferrous metals, refer to the <i>Engineering Data</i> on page 68.)			
Standard sensing object		Iron, 9 × 9 × 1 mm	Iron, 18 × 18 × 1 mm	Iron, 36 × 36 × 1 mm	Iron, 66 × 66 × 1 mm
Response frequency *1		1,000 Hz	800 Hz	500 Hz	200 Hz
Power supply voltage		10 to 30 VDC (including 10% ripple (p-p)), Class 2			
Current consumption		1-output models: 16 mA max.	1-output models: 16 mA max. 2-output models: 20 mA max.		
Output configuration		B□ Models: PNP open collector, C□ Models: NPN open collector			
Operation mode (with sensing object approaching)		1-output models (B1, C1): NO (Normally open), 1-output models (B2, C2): NC (Normally closed)	1-output models (B1, C1): NO (Normally open), 1-output models (B2, C2): NC (Normally closed), 2-output models (B3, C3): NO+NC (Normally open, Normally closed)		
Control output	Load current	1-output models: 10 to 30 VDC, Class 2, 100 mA max.	1-output models: 10 to 30 VDC, Class 2, 100 mA max., 2-output models: 10 to 30 VDC, Class 2, 50 mA max.		
	Residual voltage	1-output models: 2 V max. (Load current: 100 mA, Cable length: 2 m)	1-output models: 2 V max. (Load current: 100 mA, Cable length: 2 m), 2-output models: 2 V max. (Load current: 50 mA, Cable length: 2 m)		
Indicator *2		In the Standard I/O mode (SIO mode): Operation indicator (orange, lit) and communication indicator (green, not lit) In the IO-Link communication mode (COM mode): Operation indicator (orange, lit) and communication indicator (green, blinking at 1 s intervals)			
Protection circuits		Power supply reverse polarity protection, Surge suppressor, Output short-circuit protection, Output reverse polarity protection			
Ambient temperature range		Operating/Storage: -25 to 70°C (with no icing or condensation)			
Ambient humidity range		Operating/Storage: 35% to 95% (with no condensation)			
Temperature influence		±10% max. of sensing distance at 23°C in the temperature range of -25 to 70°C			
Voltage influence		±1% max. of sensing distance at rated voltage in the rated voltage ±15% range			
Insulation resistance		50 MΩ min. (at 500 VDC) between current-carrying parts and case			
Dielectric strength		1,000 VAC, 50/60 Hz for 1 minute between current-carrying parts and case			
Vibration resistance (destruction)		10 to 55 Hz, 1.5-mm double amplitude for 2 hours each in X, Y, and Z directions			
Shock resistance (destruction)		500 m/s <sup>2</sup> 10 times each in X, Y, and Z directions	1,000 m/s <sup>2</sup> 10 times each in X, Y, and Z directions		
Degree of protection		Pre-wired Models, Pre-wired Connector Models: IEC 60529: IP67, JIS C 0920 Annex 1: IP67G Connector Models: IEC 60529: IP67			
Connection method		Pre-wired Models (Standard cable length: 2 m) and Pre-wired Connector Models (Standard cable length: 0.3 m), M12 Connector Models			
Weight *3 (packed state)	Pre-wired Models	Approx. 85 g	Approx. 95 g	Approx. 180 g	Approx. 260 g
	M12 Pre-wired Smartclick Connector	Approx. 55 g	Approx. 70 g	Approx. 115 g	Approx. 200 g
	Connector	Approx. 40 g	Approx. 55 g	Approx. 95 g	Approx. 180 g
Materials	Case	Fluororesin coating (Base material: brass)			
	Sensing surface	Fluorine resin			
	Clamping nuts	Fluororesin coating (Base material: brass)			
	Toothed washers	Zinc-plated iron			
	Cable	Vinyl chloride (PVC)			
Main IO-Link functions *2		Operation mode switching between NO and NC, self diagnosis enabling, excessive proximity judgment distance selecting, timer function of the control output and timer time selecting, instability output (IO-Link mode) ON delay timer time selecting function, monitor output, operating hours read-out, readout of the sensor internal temperature, and initial reset			
IO-Link Communication specifications *2	IO-Link specification	Ver 1.1			
	Baud rate	COM2 (38.4 kbps), COM3 (230.4 kbps)			
	Data length	PD size: 2 bytes, OD size: 1 byte (M-sequence type: TYPE_2_2)			
	Minimum cycle time	COM2: 2.3 ms, COM3: 0.4 ms			
Accessories		Instruction manual, Clamping nuts, Toothed washer			

\*1. The response frequency is an average value. Measurement conditions are as follows: standard sensing object, a distance of twice the standard sensing object, and a set distance of half the sensing distance.

\*2. IO-Link is not supported for NC-type PNP outputs or all types of NPN outputs.

\*3. Weight of the standard body-sized model.

# E2E/E2EQ NEXT Series

## BASIC Model

### E2E NEXT Series (Double/Single distance model)

#### DC 3-wire

#### Shielded

Item	Types Size Model	Double distance				Single distance			
		M8	M12	M18	M30	M8	M12	M18	M30
		E2E-X2□8	E2E-X4□12	E2E-X8□18	E2E-X15□30	E2E-X1R5□8	E2E-X2□12	E2E-X5□18	E2E-X10□30
<b>Sensing distance</b>		2 mm±10%	4 mm±10%	8 mm±10%	15 mm±10%	1.5 mm±10%	2 mm±10%	5 mm±10%	10 mm±10%
<b>Setting distance</b>		0 to 1.6 mm	0 to 3.2 mm	0 to 6.4 mm	0 to 12 mm	0 to 1.2 mm	0 to 1.6 mm	0 to 4 mm	0 to 8 mm
<b>Differential travel</b>		15% max. of sensing distance				10% max. of sensing distance			
<b>Detectable object</b>		Ferrous metals (For non-ferrous metals, refer to the <i>Engineering Data</i> on page 68.)							
<b>Standard sensing object</b>		Iron, 8 × 8 × 1 mm	Iron, 12 × 12 × 1 mm	Iron, 24 × 24 × 1 mm	Iron, 45 × 45 × 1 mm	Iron, 8 × 8 × 1 mm	Iron, 12 × 12 × 1 mm	Iron, 18 × 18 × 1 mm	Iron, 30 × 30 × 1 mm
<b>Response frequency *1</b>		1,500 Hz	1,000 Hz	500 Hz	250 Hz	2,000 Hz	1,500 Hz	600 Hz	400 Hz
<b>Power supply voltage</b>		10 to 30 VDC (including 10% ripple (p-p)), Class 2							
<b>Current consumption</b>		1-output models: 16 mA max. 2-output models: 20 mA max.							
<b>Output configuration</b>		B□ Models: PNP open collector C□ Models: NPN open collector							
<b>Operation mode (with sensing object approaching)</b>		1-output models (B1, C1): NO (Normally open), 1-output models (B2, C2): NC (Normally closed), 2-output models (B3, C3): NO+NC (Normally open, Normally closed) *3							
<b>Control output</b>	<b>Load current</b>	1-output models: 10 to 30 VDC, Class 2, 200 mA max., (-40 to 70°C), 100 mA max., (70 to 85°C) 2-output models: 10 to 30 VDC, Class 2, 50 mA max.	1-output models: 10 to 30 VDC, Class 2, 200 mA max., 2-output models: 10 to 30 VDC, Class 2, 100 mA max.			1-output models: 10 to 30 VDC, Class 2, 200 mA max., (-40 to 70°C), 100 mA max., (70 to 85°C) 2-output models: 10 to 30 VDC, Class 2, 50 mA max.	1-output models: 10 to 30 VDC, Class 2, 200 mA max., 2-output models: 10 to 30 VDC, Class 2, 100 mA max.		
	<b>Residual voltage</b>	1-output models: 2 V max. (Load current: 200 mA, Cable length: 2 m), 2-output models: 2 V max. (Load current: 50 mA, Cable length: 2 m)	1-output models: 2 V max. (Load current: 200 mA, Cable length: 2 m), 2-output models: 2 V max. (Load current: 100 mA, Cable length: 2 m)			1-output models: 2 V max. (Load current: 200 mA, Cable length: 2 m), 2-output models: 2 V max. (Load current: 50 mA, Cable length: 2 m)	1-output models: 2 V max. (Load current: 200 mA, Cable length: 2 m), 2-output models: 2 V max. (Load current: 100 mA, Cable length: 2 m)		
<b>Indicator *2</b>		In the Standard I/O mode (SIO mode): Operation indicator (orange, lit) and communication indicator (green, not lit) In the IO-Link communication mode (COM mode): Operation indicator (orange, lit) and communication indicator (green, blinking at 1 s intervals)							
<b>Protection circuits</b>		Power supply reverse polarity protection, Surge suppressor, Output short-circuit protection, Output reverse polarity protection							
<b>Ambient temperature range</b>		Operating/Storage: -40 to 85°C (with no icing or condensation) <b>Note:</b> The UL temperature rating for M12 Pre-wired Connector Models is -25 to 70°C.							
<b>Ambient humidity range</b>		Operating/Storage: 35% to 95% (with no condensation)							
<b>Temperature influence</b>		±15% max. of sensing distance at 23°C in the temperature range of -40 to 85°C ±10% max. of sensing distance at 23°C in the temperature range of -25 to 70°C							
<b>Voltage influence</b>		±1% max. of sensing distance at rated voltage in the rated voltage ±15% range							
<b>Insulation resistance</b>		50 MΩ min. (at 500 VDC) between current-carrying parts and case							
<b>Dielectric strength</b>		1,000 VAC, 50/60 Hz for 1 minute between current-carrying parts and case							
<b>Vibration resistance (destruction)</b>		10 to 55 Hz, 1.5-mm double amplitude for 2 hours each in X, Y, and Z directions							
<b>Shock resistance (destruction)</b>		500 m/s <sup>2</sup> 10 times each in X, Y, and Z directions	1,000 m/s <sup>2</sup> 10 times each in X, Y, and Z directions			500 m/s <sup>2</sup> 10 times each in X, Y, and Z directions	1,000 m/s <sup>2</sup> 10 times each in X, Y, and Z directions		
<b>Degree of protection</b>		Pre-wired Models, Pre-wired Connector Models: IEC 60529:IP67, ISO 20653 (old standard: DIN 40050 PART9): IP69K, JIS C 0920 Annex 1: IP67G, Passed OMRON's Oil-resistant Component Evaluation Standards *4 (Cutting oil type: specified in JIS K 2241:2000; Temperature: 35°C max.) Connector Models: IEC 60529: IP67, ISO 20653 (old standard: DIN 40050 PART9): IP69K							
<b>Connection method</b>		Pre-wired Models (Standard cable length: 2 m), Pre-wired Connector Models (Standard cable length: 0.3 m) and Connector Models (M12 Connector, M8 (4-pin) Connector and M8 (3-pin) Connector)							
<b>Weight *5 (packed state)</b>	<b>Pre-wired</b>	Approx. 85 g	Approx. 95 g	Approx. 170 g	Approx. 240 g	Approx. 85 g	Approx. 95 g	Approx. 170 g	Approx. 240 g
	<b>M12 Pre-wired Smartclick Connector</b>	Approx. 55 g	Approx. 70 g	Approx. 105 g	Approx. 170 g	Approx. 55 g	Approx. 70 g	Approx. 105 g	Approx. 170 g
	<b>Connector</b>	Approx. 40 g *6	Approx. 55 g	Approx. 85 g	Approx. 160 g	Approx. 40 g *6	Approx. 55 g	Approx. 85 g	Approx. 160 g

Item	Types Size Model	Double distance				Single distance			
		M8	M12	M18	M30	M8	M12	M18	M30
		E2E-X2□8	E2E-X4□12	E2E-X8□18	E2E-X15□30	E2E-X1R5□8	E2E-X2□12	E2E-X5□18	E2E-X10□30
Materials	Case	Stainless (SUS303)	Nickel-plated brass			Stainless (SUS303)	Nickel-plated brass		
	Sensing surface	Polybutylene terephthalat (PBT)							
	Clamping nuts	Nickel-plated brass							
	Toothed washers	Zinc-plated iron							
	Cable	Vinyl chloride (PVC)							
Main IO-Link functions *2		Operation mode switching between NO and NC, self diagnosis enabling, excessive proximity judgment distance selecting, timer function of the control output and timer time selecting, instability output (IO-Link mode) ON delay timer time selecting function, monitor output, operating hours read-out, readout of the sensor internal temperature, and initial reset							
IO-Link Communication specifications *2	IO-Link specification	Ver1.1							
	Baud rate	COM2 (38.4 kbps), COM3 (230.4 kbps)							
	Data length	PD size: 2 bytes, OD size: 1 byte (M-sequence type: TYPE_2_2)							
	Minimum cycle time	COM2: 2.3 ms, COM3: 0.4 ms							
Accessories		Instruction manual, Clamping nuts, Toothed washer							

- \*1. The response frequency is an average value. Measurement conditions are as follows: standard sensing object, a distance of twice the standard sensing object, and a set distance of half the sensing distance.
- \*2. IO-Link is not supported for NC-type PNP outputs or all types of NPN outputs.
- \*3. Dual-output specification for the M8-size models is only applicable to long-size M12 Connector models.
- \*4. The Oil-resistant Component Evaluation Standards are OMRON's own durability evaluation standards. 2-year oil resistance indicates the median value of the product design and the oil-resistance performance criterion result (=Typical value). Actual performance can be expected to decline after two years on average from shipment. The Pre-wired Connector Model verifies 2 years of oil resistance when mating with Round Oil-resistant Connectors XS5 NEXT series correctly. The degree of protection is not satisfied with the part where cable wires are uncovered for the Pre-wired Models.
- \*5. Weight of the standard body-sized model.
- \*6. Both M8 connectors and M12 connectors are available.

# E2E/E2EQ NEXT Series

## BASIC Model

### E2E NEXT Series (Double/Single distance model)

#### DC 3-wire

#### Unshielded

Item	Types Size Model	Double distance model				Single distance model			
		M8	M12	M18	M30	M8	M12	M18	M30
		E2E-X4M□8	E2E-X8M□12	E2E-X16M□18	E2E-X30M□30	E2E-X2M□8	E2E-X5M□12	E2E-X10M□18	E2E-X18M□30
<b>Sensing distance</b>		4 mm±10%	8 mm±10%	16 mm±10%	30 mm±10%	2 mm±10%	5 mm±10%	10 mm±10%	18 mm±10%
<b>Setting distance</b>		0 to 3.2 mm	0 to 6.4 mm	0 to 12.8 mm	0 to 24 mm	0 to 1.6 mm	0 to 4 mm	0 to 8 mm	0 to 14.4 mm
<b>Differential travel</b>		15% max. of sensing distance				10% max. of sensing distance			
<b>Detectable object</b>		Ferrous metals (For non-ferrous metals, refer to the <i>Engineering Data</i> on page 68.)							
<b>Standard sensing object</b>		Iron, 12 × 12 × 1 mm	Iron, 24 × 24 × 1 mm	Iron, 48 × 48 × 1 mm	Iron, 90 × 90 × 1 mm	Iron, 8 × 8 × 1 mm	Iron, 15 × 15 × 1 mm	Iron, 30 × 30 × 1 mm	Iron, 54 × 54 × 1 mm
<b>Response frequency *1</b>		1,000 Hz	800 Hz	400 Hz	100 Hz	1,000 Hz	800 Hz	400 Hz	100 Hz
<b>Power supply voltage</b>		10 to 30 VDC (including 10% ripple (p-p)), Class 2							
<b>Current consumption</b>		1-output models: 16 mA max. 2-output models: 20 mA max.							
<b>Output configuration</b>		B□ Models: PNP open collector C□ Models: NPN open collector							
<b>Operation mode (with sensing object approaching)</b>		1-output models (B1, C1): NO (Normally open), 1-output models (B2, C3): NC (Normally closed) 2-output models (B3, C3): NO+NC (Normally open, Normally closed) *3							
<b>Control output</b>	<b>Load current</b>	1-output models: 10 to 30 VDC, Class 2, 200 mA max., (-40 to 70°C), 100 mA max., (70 to 85°C) 2-output models: 10 to 30 VDC, Class 2, 50 mA max.	1-output models: 10 to 30 VDC, Class 2, 200 mA max., 2-output models: 10 to 30 VDC, Class 2, 100 mA max.			1-output models: 10 to 30 VDC, Class 2, 200 mA max., (-40 to 70°C), 100 mA max., (70 to 85°C) 2-output models: 10 to 30 VDC, Class 2, 50 mA max.	1-output models: 10 to 30 VDC, Class 2, 200 mA max., 2-output models: 10 to 30 VDC, Class 2, 100 mA max.		
	<b>Residual voltage</b>	1-output models: 2 V max. (Load current: 200 mA, Cable length: 2 m), 2-output models: 2 V max. (Load current: 50 mA, Cable length: 2 m)	1-output models: 2 V max. (Load current: 200 mA, Cable length: 2 m), 2-output models: 2 V max. (Load current: 100 mA, Cable length: 2 m)			1-output models: 2 V max. (Load current: 200 mA, Cable length: 2 m), 2-output models: 2 V max. (Load current: 50 mA, Cable length: 2 m)	1-output models: 2 V max. (under load current of 200 mA with cable length of 2 m), 2-output models: 2 V max. (under load current of 100 mA with cable length of 2 m)		
<b>Indicator *2</b>		In the Standard I/O mode (SIO mode): Operation indicator (orange, lit) and communication indicator (green, not lit) In the IO-Link communication mode (COM mode): Operation indicator (orange, lit) and communication indicator (green, blinking at 1 s intervals)							
<b>Protection circuits</b>		Power supply reverse polarity protection, Surge suppressor, Output short-circuit protection, Output reverse polarity protection							
<b>Ambient temperature range</b>		Operating/Storage: -40 to 85°C (with no icing or condensation) <b>Note:</b> The UL temperature rating for M12 Pre-wired Connector Models is -25 to 70°C.							
<b>Ambient humidity range</b>		Operating/Storage: 35% to 95% (with no condensation)							
<b>Temperature influence</b>		±15% max. of sensing distance at 23°C in the temperature range of -40 to 85°C ±10% max. of sensing distance at 23°C in the temperature range of -25 to 70°C							
<b>Voltage influence</b>		±1% max. of sensing distance at rated voltage in the rated voltage ±15% range							
<b>Insulation resistance</b>		50 MΩ min. (at 500 VDC) between current-carrying parts and case							
<b>Dielectric strength</b>		1,000 VAC, 50/60 Hz for 1 minute between current-carrying parts and case							
<b>Vibration resistance (destruction)</b>		10 to 55 Hz, 1.5-mm double amplitude for 2 hours each in X, Y, and Z directions							
<b>Shock resistance (destruction)</b>		500 m/s <sup>2</sup> 10 times each in X, Y, and Z directions	1,000 m/s <sup>2</sup> 10 times each in X, Y, and Z directions			500 m/s <sup>2</sup> 10 times each in X, Y, and Z directions	1,000 m/s <sup>2</sup> 10 times each in X, Y, and Z directions		
<b>Degree of protection</b>		Pre-wired Models, Pre-wired Connector Models: IEC 60529:IP67, ISO 20653 (old standard: DIN 40050 PART9): IP69K, JIS C 0920 Annex 1: IP67G, Passed OMRON's Oil-resistant Component Evaluation Standards *4 (Cutting oil type: specified in JIS K 2241:2000; Temperature: 35°C max.) Connector Models: IEC 60529:IP67, ISO 20653 (old standard: DIN 40050 PART9): IP69K							
<b>Connection method</b>		Pre-wired Models (Standard cable length: 2 m), Pre-wired Connector Models (Standard cable length: 0.3 m) and Models (M12 Connector, M8 (4-pin) Connector and M8 (3-pin) Connector)							
<b>Weight *5 (packed state)</b>	<b>Pre-wired</b>	Approx. 85 g	Approx. 95 g	Approx. 170 g	Approx. 280 g	Approx. 85 g	Approx. 95 g	Approx. 170 g	Approx. 240 g
	<b>M12 Pre-wired Smartclick Connector</b>	Approx. 55 g	Approx. 70 g	Approx. 105 g	Approx. 220 g	Approx. 55 g	Approx. 70 g	Approx. 105 g	Approx. 170 g
	<b>Connector</b>	Approx. 40 g *6	Approx. 55 g	Approx. 85 g	Approx. 200 g	Approx. 40 g *6	Approx. 55 g	Approx. 85 g	Approx. 160 g

Item	Types Size Model	Double distance model				Single distance model			
		M8	M12	M18	M30	M8	M12	M18	M30
		E2E-X4M□8	E2E-X8M□12	E2E-X16M□18	E2E-X30M□30	E2E-X2M□8	E2E-X5M□12	E2E-X10M□18	E2E-X18M□30
Materials	Case	Stainless (SUS303)		Nickel-plated brass		Stainless (SUS303)		Nickel-plated brass	
	Sensing surface	Polybutylene terephthalat (PBT)							
	Clamping nuts	Nickel-plated brass							
	Toothed washers	Zinc-plated iron							
	Cable	Vinyl chloride (PVC)							
Main IO-Link functions *2		Operation mode switching between NO and NC, self diagnosis enabling, excessive proximity judgment distance selecting, timer function of the control output and timer time selecting, instability output (IO-Link mode) ON delay timer time selecting function, monitor output, operating hours read-out, readout of the sensor internal temperature, and initial reset							
IO-Link Communication specifications *2	IO-Link specification	Ver 1.1							
	Baud rate	COM2 (38.4 kbps), COM3 (230.4 kbps)							
	Data length	PD size: 2 bytes, OD size: 1 byte (M-sequence type: TYPE_2_2)							
	Minimum cycle time	COM2: 2.3 ms, COM3: 0.4 ms							
Accessories		Instruction manual, Clamping nuts, Toothed washer							

\*1. The response frequency is an average value. Measurement conditions are as follows: standard sensing object, a distance of twice the standard sensing object, and a set distance of half the sensing distance.

\*2. IO-Link is not supported for NC-type PNP outputs or all types of NPN outputs.

\*3. Dual-output specification for the M8-size models is only applicable to long-size M12 Connector models.

\*4. The Oil-resistant Component Evaluation Standards are OMRON's own durability evaluation standards. 2-year oil resistance indicates the median value of the product design and the oil-resistance performance criterion result (=Typical value). Actual performance can be expected to decline after two years on average from shipment. The Pre-wired Connector Model verifies 2 years of oil resistance when mating with Round Oil-resistant Connectors XS5 NEXT series correctly. The degree of protection is not satisfied with the part where cable wires are uncovered for the Pre-wired Models.

\*5. Weight of the standard body-sized model.

\*6. Both M8 connectors and M12 connectors are available.



# E2E/E2EQ NEXT Series

## BASIC Model

### E2E Q NEXT Series (Spatter-resistant Double distance/Single distance model)

#### DC 3-Wire Models

#### Shielded

Item	Types Size Model	Double distance				Single distance			
		M8	M12	M18	M30	M8	M12	M18	M30
		E2EQ-X2□8	E2EQ-X4□12	E2EQ-X8□18	E2EQ-X15□30	E2EQ-X1R5□8	E2EQ-X2□12	E2EQ-X5□18	E2EQ-X10□30
<b>Sensing distance</b>		2 mm±10%	4 mm±10%	8 mm±10%	15 mm±10%	1.5 mm±10%	2 mm±10%	5 mm±10%	10 mm±10%
<b>Setting distance</b>		0 to 1.6 mm	0 to 3.2 mm	0 to 6.4 mm	0 to 12 mm	0 to 1.2 mm	0 to 1.6 mm	0 to 4 mm	0 to 8 mm
<b>Differential travel</b>		15% max. of sensing distance				10% max. of sensing distance			
<b>Detectable object</b>		Ferrous metals (For non-ferrous metals, refer to the <i>Engineering Data</i> on page 68.)							
<b>Standard sensing object</b>		Iron, 8 × 8 × 1 mm	Iron, 12 × 12 × 1 mm	Iron, 24 × 24 × 1 mm	Iron, 45 × 45 × 1 mm	Iron, 8 × 8 × 1 mm	Iron, 12 × 12 × 1 mm	Iron, 18 × 18 × 1 mm	Iron, 30 × 30 × 1 mm
<b>Response frequency *1</b>		1,500 Hz	1,000 Hz	500 Hz	250 Hz	2,000 Hz	1,500 Hz	600 Hz	400 Hz
<b>Power supply voltage</b>		10 to 30 VDC (including 10% ripple (p-p)), Class 2							
<b>Current consumption</b>		1-output models: 16 mA max. 2-output models: 20 mA max.							
<b>Output configuration</b>		B□ Models: PNP open collector, C□ Models: NPN open collector							
<b>Operation mode (with sensing object approaching)</b>		1-output models (B1, C1): NO (Normally open), 1-output models (B2, C2): NC (Normally closed) 2-output models (B3, C3): NO+NC (Normally open, Normally closed)							
<b>Control output</b>	<b>Load current</b>	1-output models: 10 to 30 VDC, Class 2, 200 mA max., (-40 to 70°C), 100 mA max., (70 to 85°C) 2-output models: 10 to 30 VDC, Class 2, 50 mA max.	1-output models: 10 to 30 VDC, Class 2, 200 mA max., 2-output models: 10 to 30 VDC, Class 2, 100 mA max.			1-output models: 10 to 30 VDC, Class 2, 200 mA max., (-40 to 70°C), 100 mA max., (70 to 85°C) 2-output models: 10 to 30 VDC, Class 2, 50 mA max.	1-output models: 10 to 30 VDC, Class 2, 200 mA max., 2-output models: 10 to 30 VDC, Class 2, 100 mA max.		
	<b>Residual voltage</b>	1-output models: 2 V max. (Load current: 200 mA, Cable length: 2 m), 2-output models: 2 V max. (Load current: 50 mA, Cable length: 2 m)	1-output models: 2 V max. (Load current: 200 mA, Cable length: 2 m), 2-output models: 2 V max. (Load current: 100 mA, Cable length: 2 m)			1-output models: 2 V max. (Load current: 200 mA, Cable length: 2 m), 2-output models: 2 V max. (Load current: 50 mA, Cable length: 2 m)	1-output models: 2 V max. (Load current: 200 mA, Cable length: 2 m), 2-output models: 2 V max. (Load current: 100 mA, Cable length: 2 m)		
<b>Indicator *2</b>		In the Standard I/O mode (SIO mode): Operation indicator (orange, lit) and communication indicator (green, not lit) In the IO-Link communication mode (COM mode): Operation indicator (orange, lit) and communication indicator (green, blinking at 1 s intervals)							
<b>Protection circuits</b>		Power supply reverse polarity protection, Surge suppressor, Output short-circuit protection, Output reverse polarity protection							
<b>Ambient temperature range</b>		Operating/Storage: -40 to 85°C (with no icing or condensation) <b>Note:</b> The UL temperature rating for M12 Pre-wired Connector Models is -25 to 70°C.							
<b>Ambient humidity range</b>		Operating/Storage: 35% to 95% (with no condensation)							
<b>Temperature influence</b>		±15% max. of sensing distance at 23°C in the temperature range of -40 to 85°C ±10% max. of sensing distance at 23°C in the temperature range of -25 to 70°C							
<b>Voltage influence</b>		±1% max. of sensing distance at rated voltage in the rated voltage ±15% range							
<b>Insulation resistance</b>		50 MΩ min. (at 500 VDC) between current-carrying parts and case							
<b>Dielectric strength</b>		1,000 VAC, 50/60 Hz for 1 minute between current-carrying parts and case							
<b>Vibration resistance (destruction)</b>		10 to 55 Hz, 1.5-mm double amplitude for 2 hours each in X, Y, and Z directions							
<b>Shock resistance (destruction)</b>		500 m/s <sup>2</sup> 10 times each in X, Y, and Z directions	1,000 m/s <sup>2</sup> 10 times each in X, Y, and Z directions			500 m/s <sup>2</sup> 10 times each in X, Y, and Z directions	1,000 m/s <sup>2</sup> 10 times each in X, Y, and Z directions		
<b>Degree of protection</b>		Pre-wired Models, Pre-wired Connector Models: IEC 60529:IP67, JIS C 0920 Annex 1: IP67G Connector Models: IEC 60529 IP67							
<b>Connection method</b>		Pre-wired Models (Standard cable length: 2 m) and Pre-wired Connector Models (Standard cable length: 0.3 m), M12 Connector Models							
<b>Weight *3 (packed state)</b>	<b>Pre-wired</b>	Approx. 85 g	Approx. 95 g	Approx. 170 g	Approx. 240 g	Approx. 85 g	Approx. 95 g	Approx. 170 g	Approx. 240 g
	<b>M12 Pre-wired Smartclick Connector</b>	Approx. 55 g	Approx. 70 g	Approx. 105 g	Approx. 170 g	Approx. 55 g	Approx. 70 g	Approx. 105 g	Approx. 170 g
	<b>Connector</b>	Approx. 40 g	Approx. 55 g	Approx. 85 g	Approx. 160 g	Approx. 40 g	Approx. 55 g	Approx. 85 g	Approx. 160 g

Item	Types Size Model	Double distance				Single distance			
		M8	M12	M18	M30	M8	M12	M18	M30
		E2EQ-X2□8	E2EQ-X4□12	E2EQ-X8□18	E2EQ-X15□30	E2EQ-X1R5□8	E2EQ-X2□12	E2EQ-X5□18	E2EQ-X10□30
Materials	Case	Fluororesin coating (Base material: SUS303)	Fluororesin coating (Base material: brass)			Fluororesin coating (Base material: SUS303)	Fluororesin coating (Base material: brass)		
	Sensing surface	Fluorine resin							
	Clamping nuts	Fluororesin coating (Base material: brass)							
	Toothed washers	Zinc-plated iron							
	Cable	Vinyl chloride (PVC)							
Main IO-Link functions *2		Operation mode switching between NO and NC, self diagnosis enabling, excessive proximity judgment distance selecting, timer function of the control output and timer time selecting, instability output (IO-Link mode) ON delay timer time selecting function, monitor output, operating hours read-out, readout of the sensor internal temperature, and initial reset							
IO-Link Communication specifications *2	IO-Link specification	Ver1.1							
	Baud rate	COM2 (38.4 kbps), COM3 (230.4 kbps)							
	Data length	PD size: 2 bytes, OD size: 1 byte (M-sequence type: TYPE_2_2)							
	Minimum cycle time	COM2: 2.3 ms, COM3: 0.4 ms							
Accessories		Instruction manual, Clamping nuts, Toothed washer							

\*1. The response frequency is an average value. Measurement conditions are as follows: standard sensing object, a distance of twice the standard sensing object, and a set distance of half the sensing distance.

\*2. IO-Link is not supported for NC-type PNP outputs or all types of NPN outputs.

\*3. Weight of the standard body-sized model.

# E2E/E2EQ NEXT Series

## Engineering Data (Reference Value)

### Sensing Area

#### PREMIUM Model

##### Quadruple distance model

###### Shielded

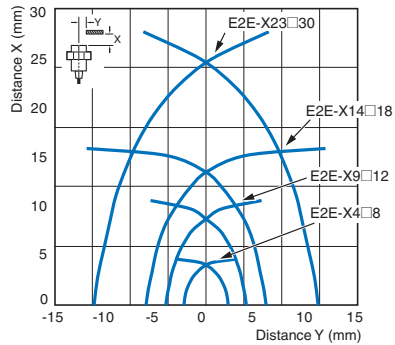

###### Unshielded

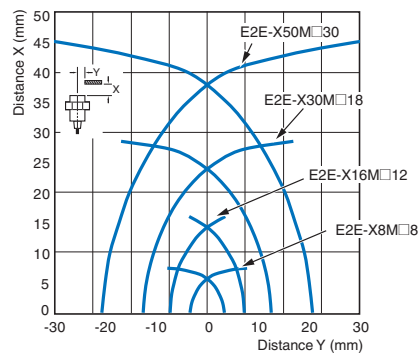

##### Triple distance model, Spatter-resistant Triple distance model

###### Shielded

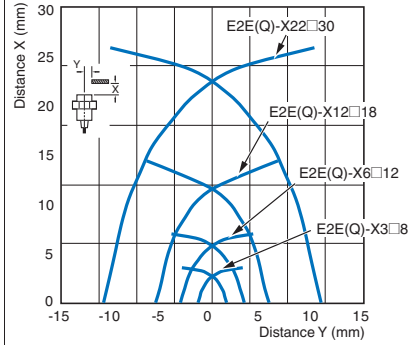

###### Unshielded

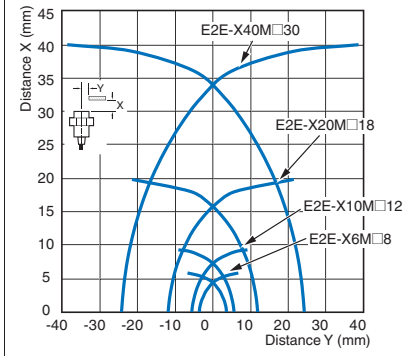

#### BASIC Model

##### Double distance model, Spatter-resistant Double distance model

###### Shielded

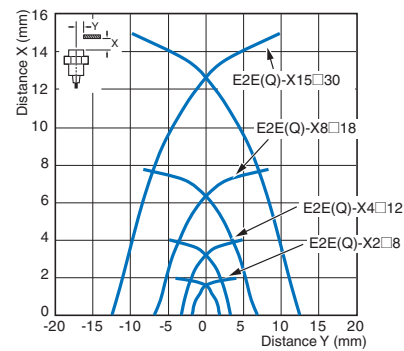

###### Unshielded

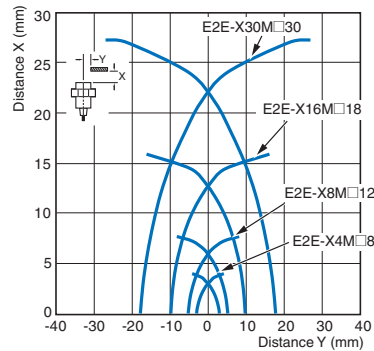

##### Single distance model, Spatter-resistant Single distance model

###### Shielded

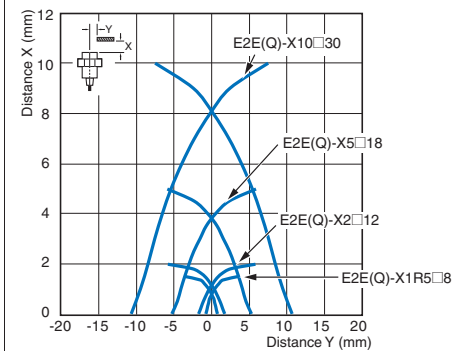

###### Unshielded

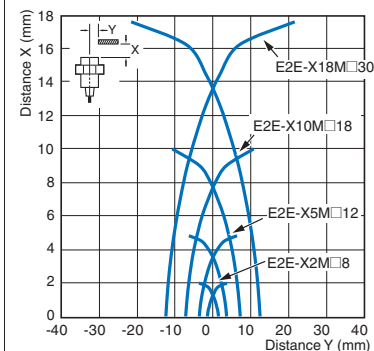

Influence of Sensing Object Size and Material

PREMIUM Model

Shielded

Quadruple distance model

Size: M8 E2E-X4□8

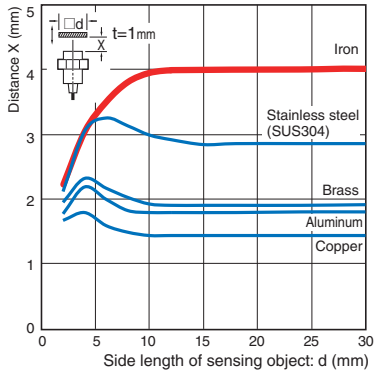

Size: M12 E2E-X9□12

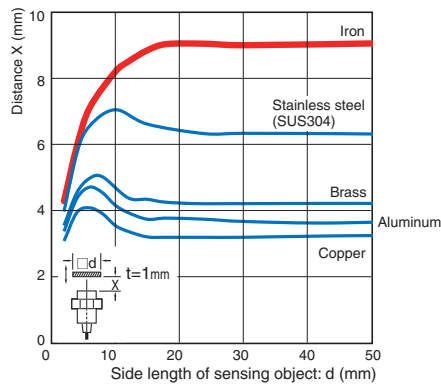

Size: M18 E2E-X14□18

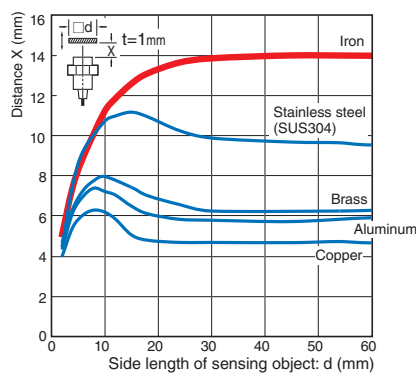

Size: M30 E2E-X23□30

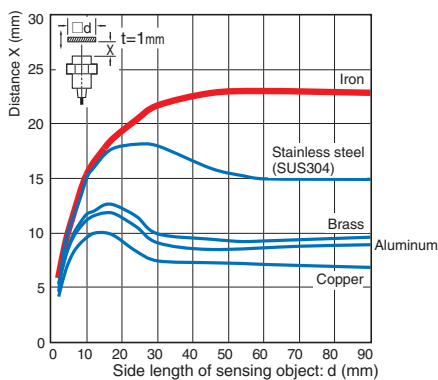

Triple distance model, Spatter-resistant Triple distance model

Size: M8 E2E(Q)-X3□8

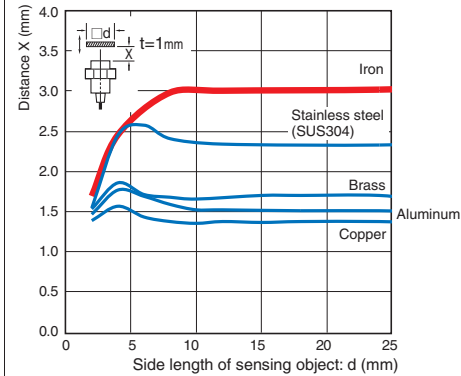

Size: M12 E2E(Q)-X6□12

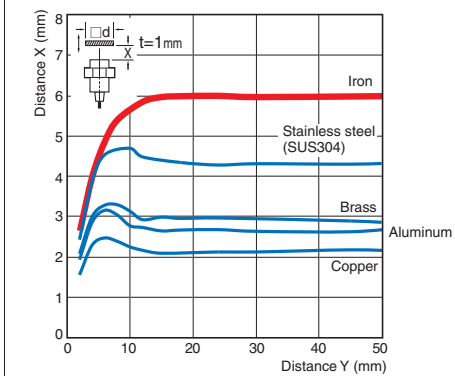

Size: M18 E2E(Q)-X12□18

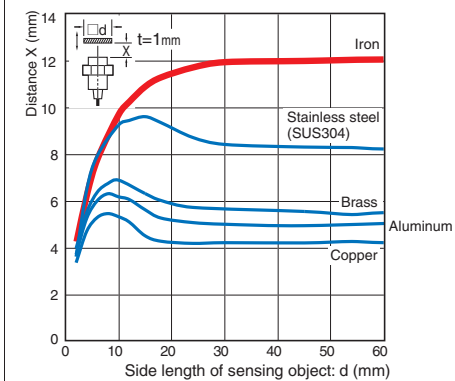

Size: M30 E2E(Q)-X22□30

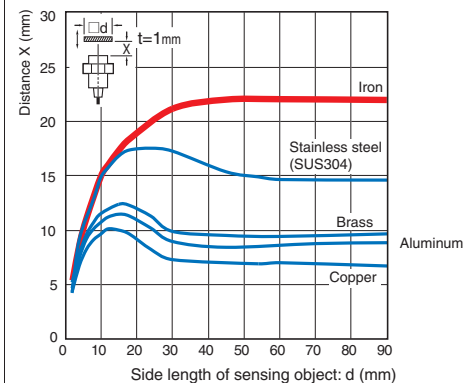

## PREMIUM Model

### Unshielded

#### Quadruple distance model

##### Size: M8 E2E-X8M□8

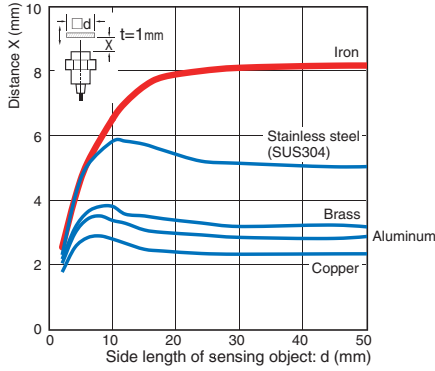

##### Size: M12 E2E-X16M□12

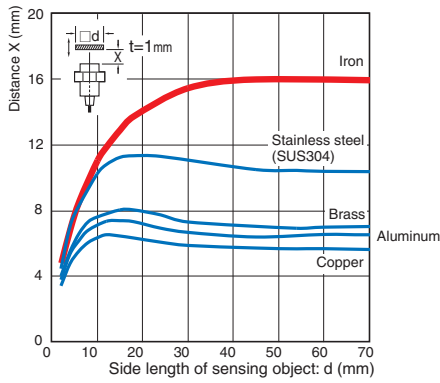

##### Size: M18 E2E-X30M□18

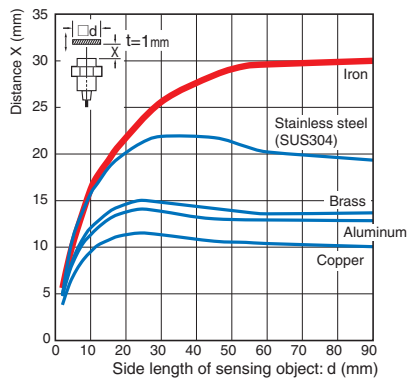

##### Size: M30 E2E-X50M□30

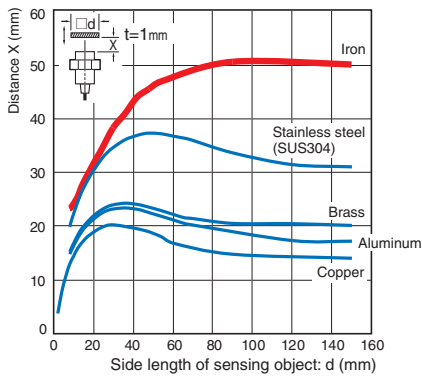

#### Triple distance model

##### Size: M8 E2E-X6M□8

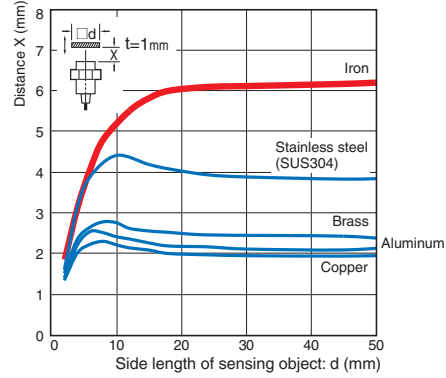

##### Size: M12 E2E-X10M□12

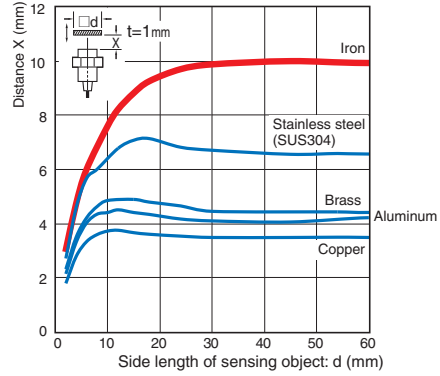

##### Size: M18 E2E-X20M□18

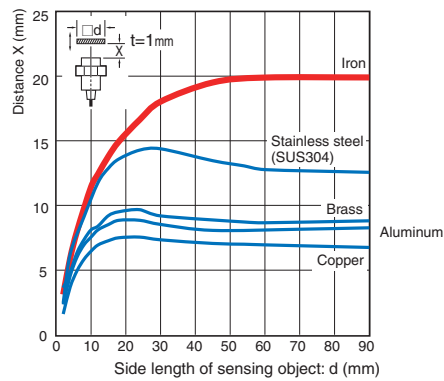

##### Size: M30 E2E-X40M□30

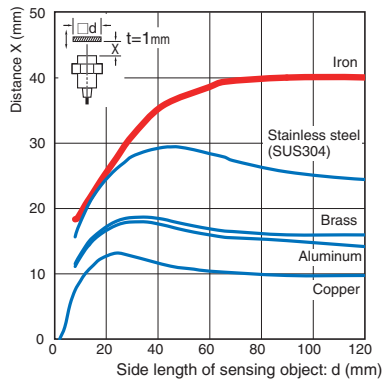

**BASIC Model**

**Shielded**

Double distance model, Spatter-resistant Double distance model

Size: M8 E2E(Q)-X2□8

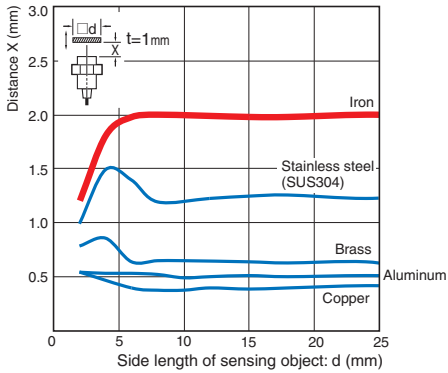

Size: M12 E2E(Q)-X4□12

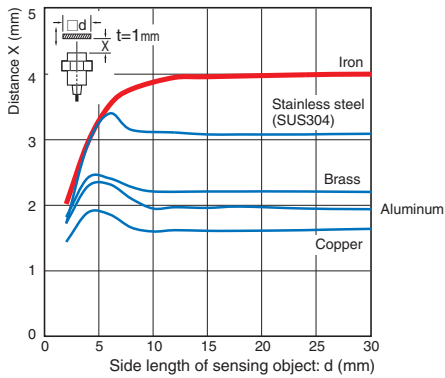

Size: M18 E2E(Q)-X8□18

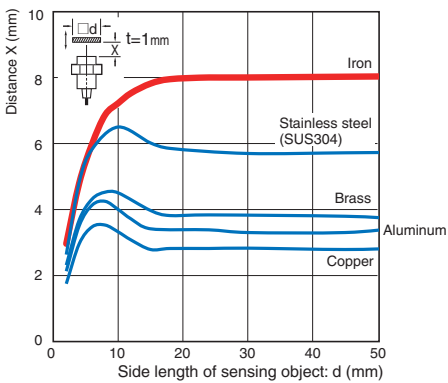

Size: M30 E2E(Q)-X15□30

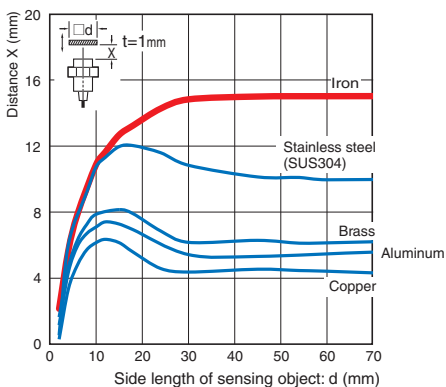

Single distance model, Spatter-resistant Single distance model

Size: M8 E2E(Q)-X1R5□8

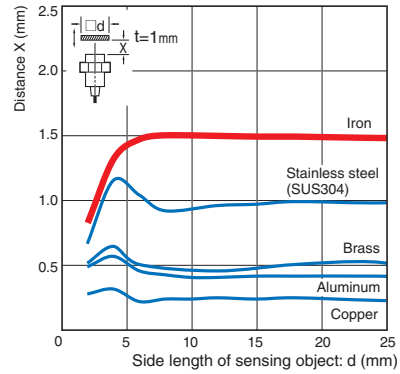

Size: M12 E2E(Q)-X2□12

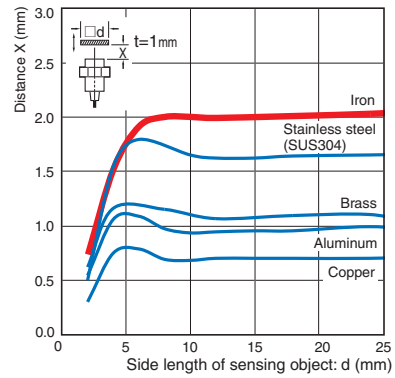

Size: M18 E2E(Q)-X5□18

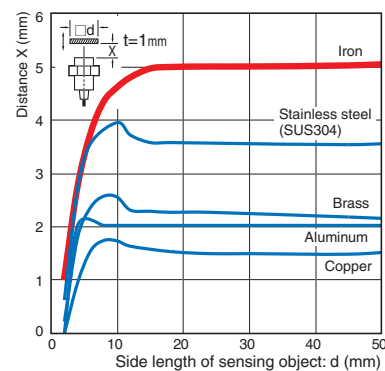

Size: M30 E2E(Q)-X10□30

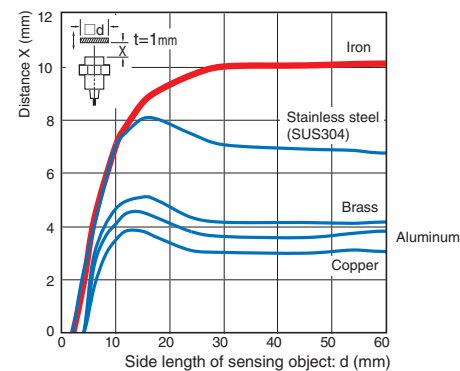

## BASIC Model

### Unshielded

#### Double distance model

##### Size: M8 E2E-X4M□8

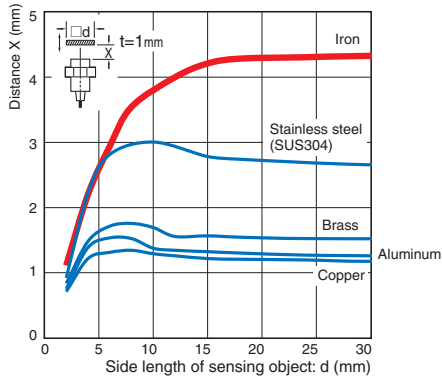

##### Size: M12 E2E-X8M□12

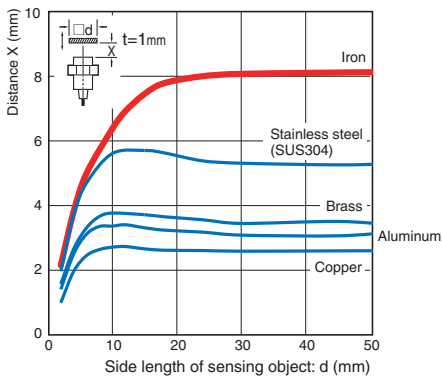

##### Size: M18 E2E-X16M□18

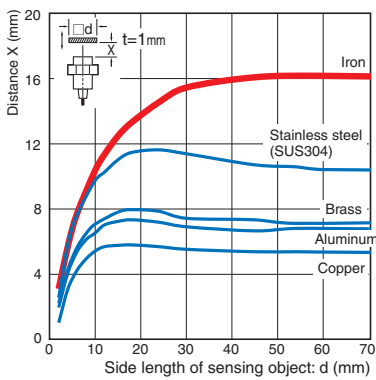

##### Size: M30 E2E-X30M□30

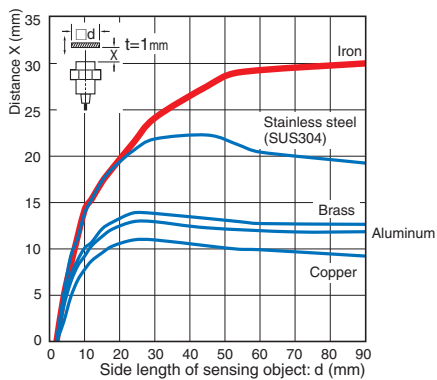

#### Single distance model

##### Size: M8 E2E-X2M□8

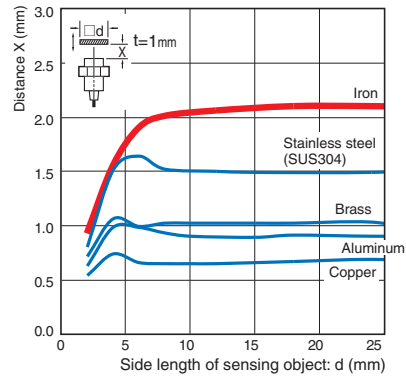

##### Size: M12 E2E-X5M□12

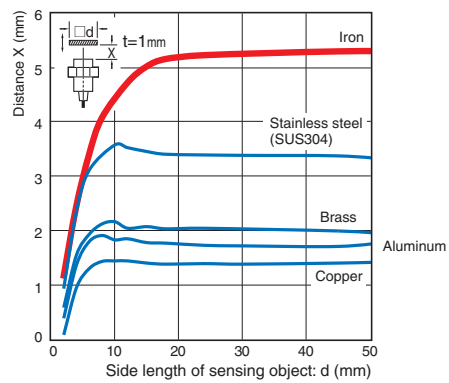

##### Size: M18 E2E-X10M□18

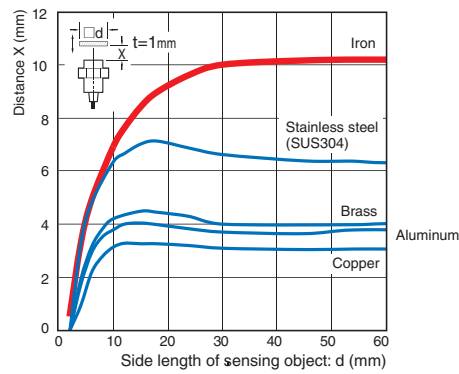

##### Size: M30 E2E-X18M□30

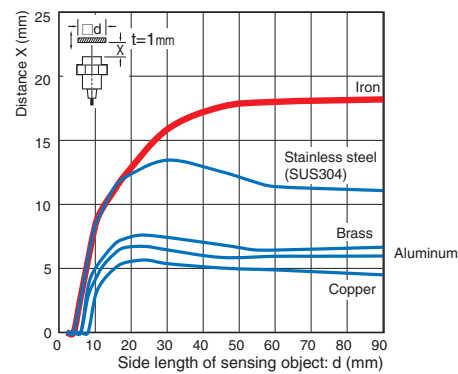



Monitor Output vs. Sensing Distance

PREMIUM Model

Shielded

Quadruple distance model

Size: M8 E2E-X4□8

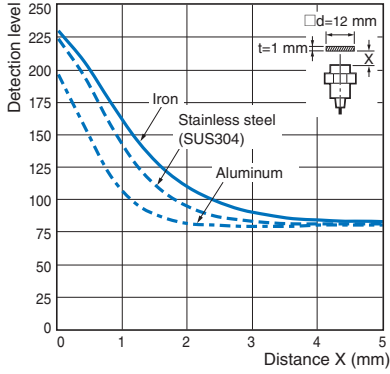

Size: M12 E2E-X9□12

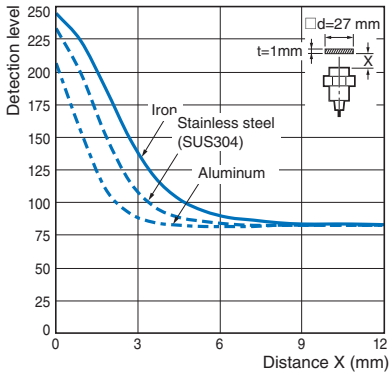

Size: M18 E2E-X14□18

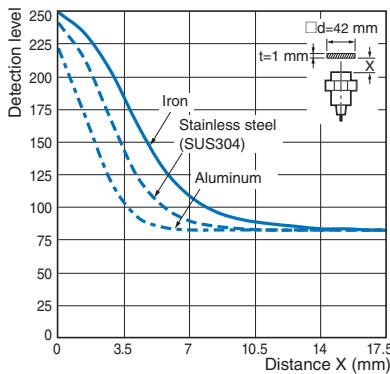

Size: M30 E2E-X23□30

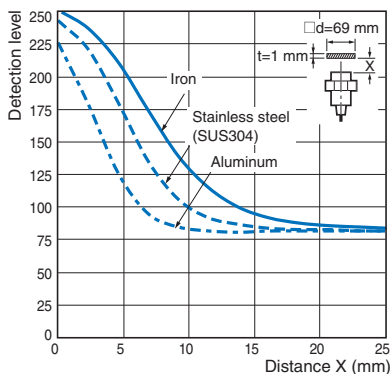

Triple model, Spatter-resistant Triple distance model

Size: M8 E2E(Q)-X3□8

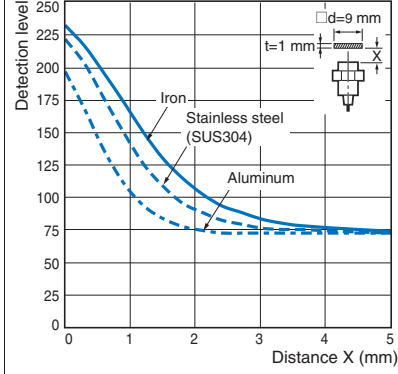

Size: M12 E2E(Q)-X6□12

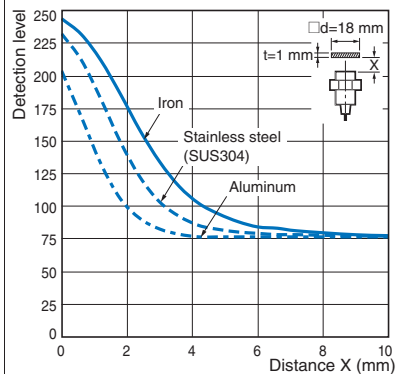

Size: M18 E2E(Q)-X12□18

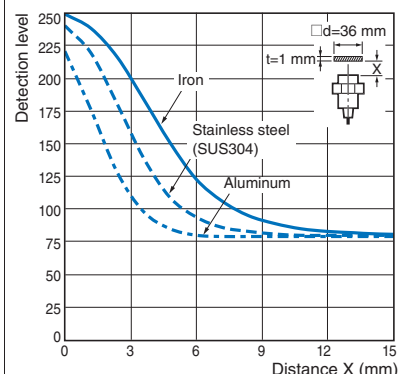

Size: M30 E2E(Q)-X22□30

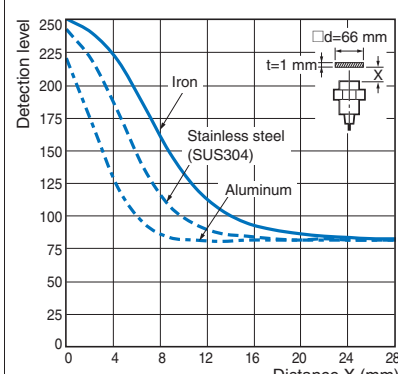

## PREMIUM Model

### Unshielded

#### Quadruple distance model

##### Size: M8 E2E-X8M□8

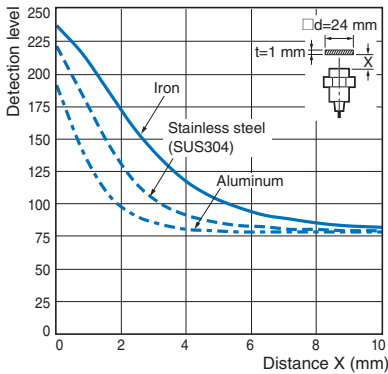

##### Size: M12 E2E-X16M□12

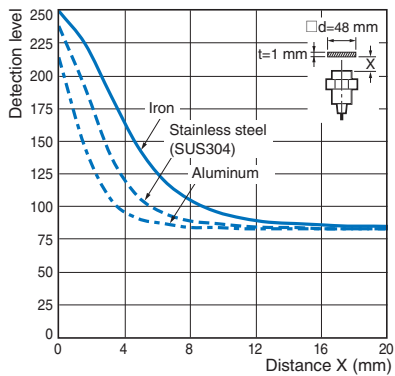

##### Size: M18 E2E-X30M□18

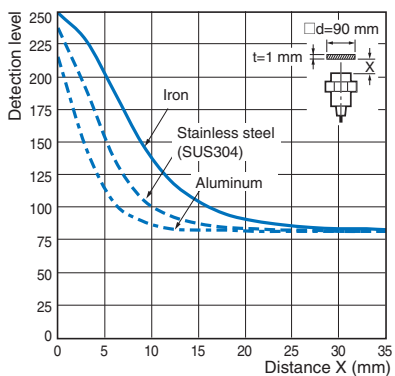

##### Size: M30 E2E-X50M□30

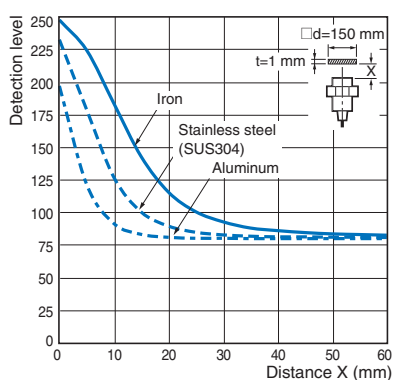

#### Triple distance model

##### Size: M8 E2E-X6M□8

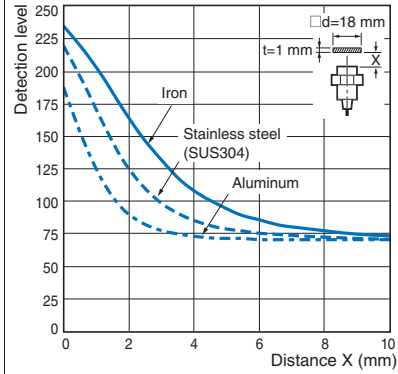

##### Size: M12 E2E-X10M□12

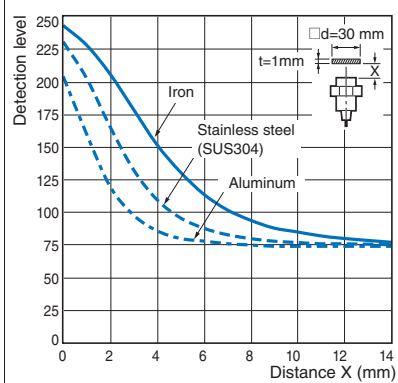

##### Size: M18 E2E-X20M□18

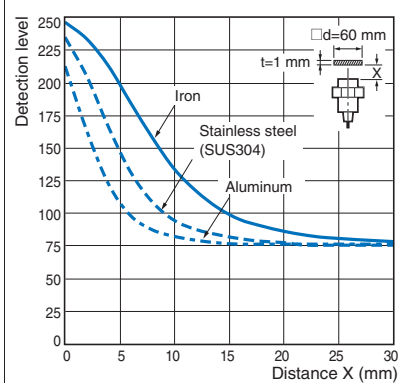

##### Size: M30 E2E-X40M□30

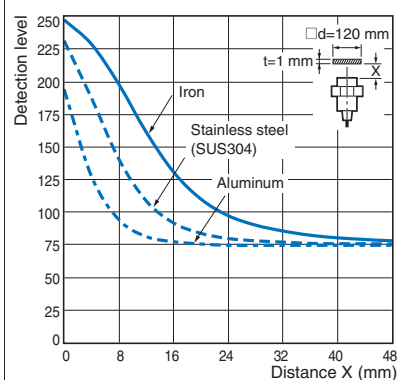

**BASIC Model**

**Shielded**

Double distance model, Spatter-resistant Double distance model

Size: M8 E2E(Q)-X2□8

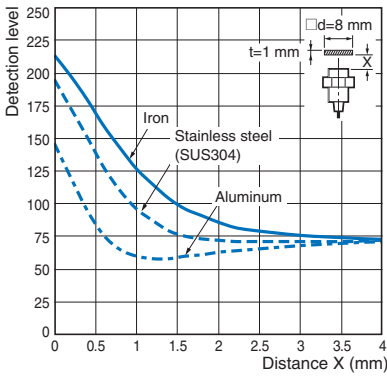

Size: M12 E2E(Q)-X4□12

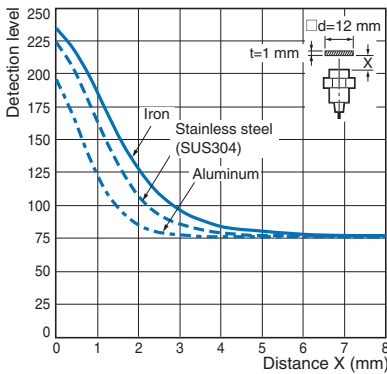

Size: M18 E2E(Q)-X8□18

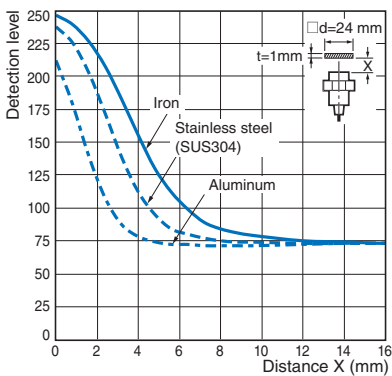

Size: M30 E2E(Q)-X15□30

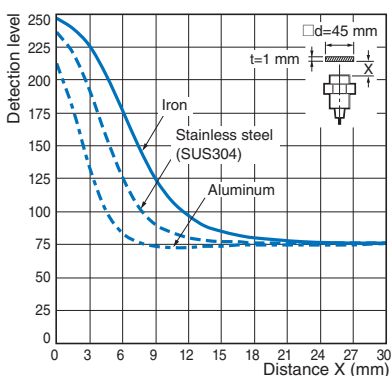

Single distance model, Spatter-resistant Single distance model

Size: M8 E2E(Q)-X1R5□8

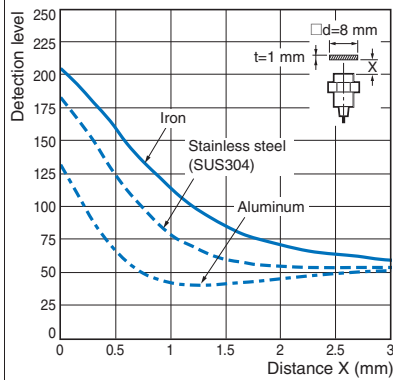

Size: M12 E2E(Q)-X2□12

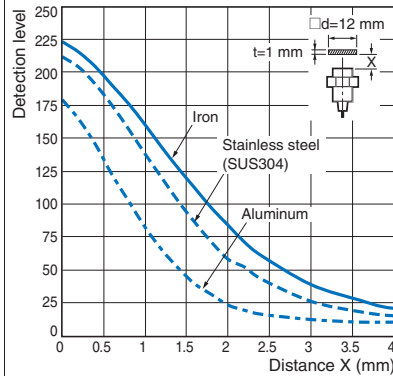

Size: M18 E2E(Q)-X5□18

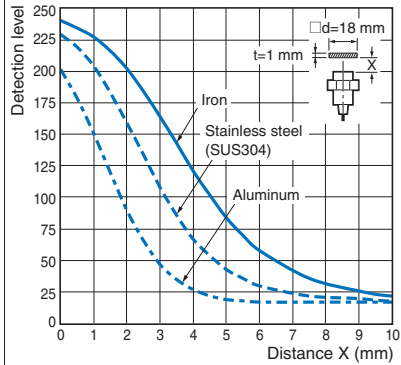

Size: M30 E2E(Q)-X10□30

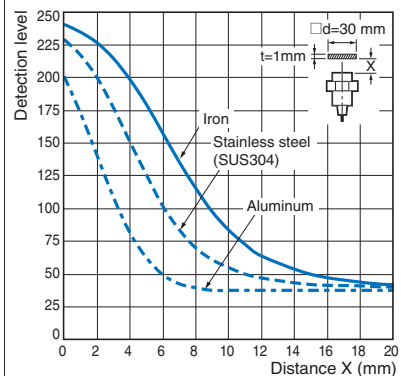

## BASIC Model

### Unshielded

#### Double distance model

##### Size: M8 E2E-X4M□8

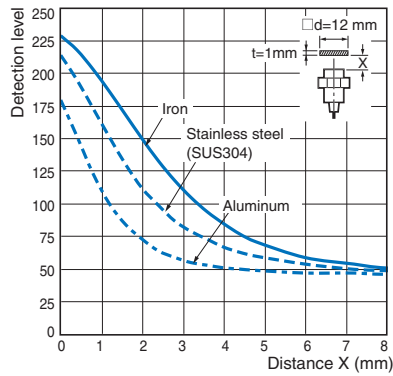

##### Size: M12 E2E-X8M□12

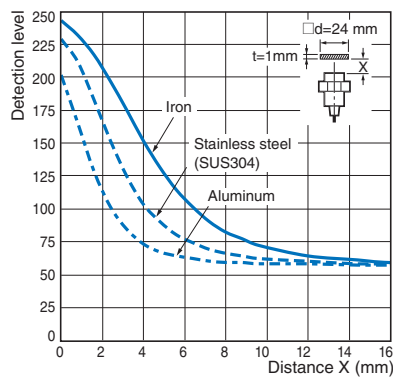

##### Size: M18 E2E-X16M□18

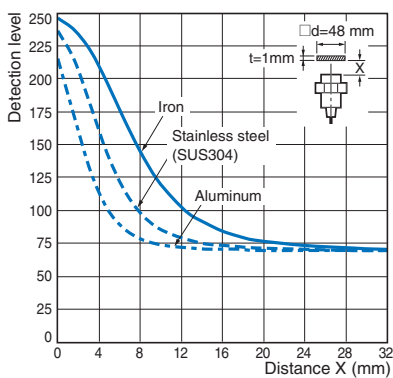

##### Size: M30 E2E-X30M□30

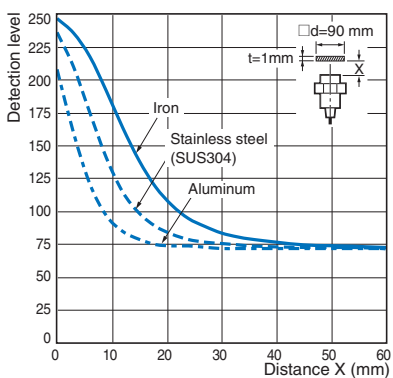

#### Single distance model

##### Size: M8 E2E-X2M□8

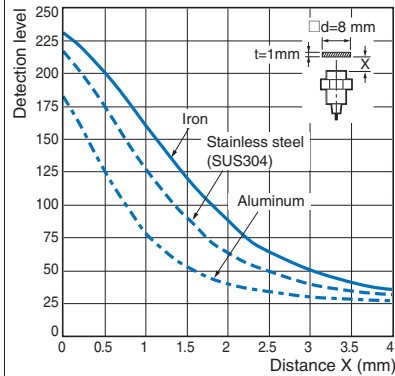

##### Size: M12 E2E-X5M□12

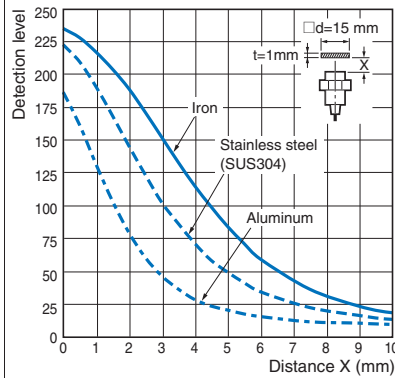

##### Size: M18 E2E-X10M□18

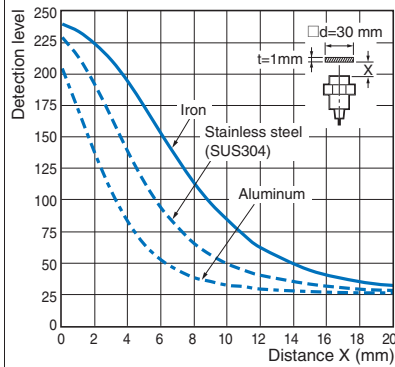

##### Size: M30 E2E-X18M□30

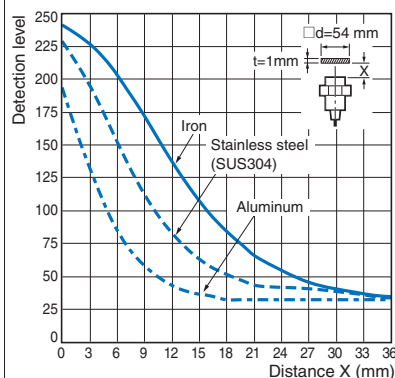

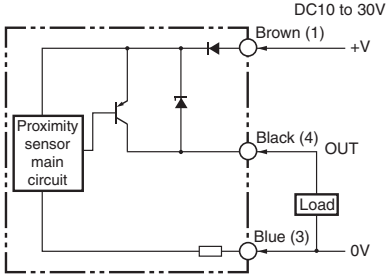
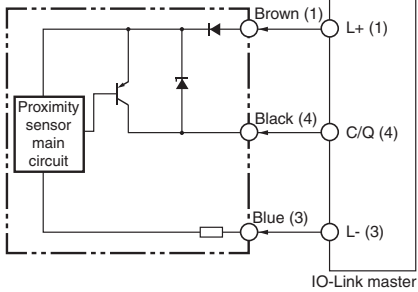
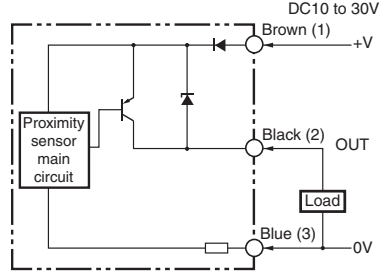
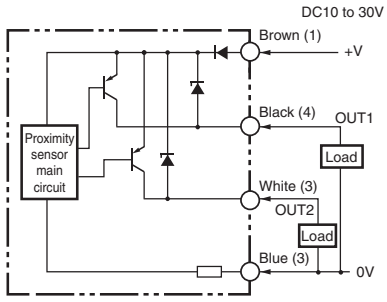
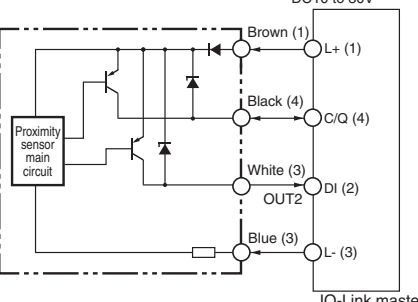

I/O Circuit Diagrams/Timing charts

DC 3-Wire  
PNP output

Operation mode	Model	Output circuit	
		Standard I/O mode (SIO mode) When using as a general	IO-Link Communication mode (COM mode) When using the Sensor connected to IO-Link Master Unit
NO	E2E(Q)-□B1		
NC	E2E(Q)-□B2	 <p>Note: M8 (3-pin) Connector: (1)(4)(3)</p>	---
NO+NC	E2E(Q)-□B3		

Connector Pin Arrangement

M12 Connector M12 Smartclick Connector	M8 (4-pin) Connector	M8 (3-pin) Connector
		

## PNP output

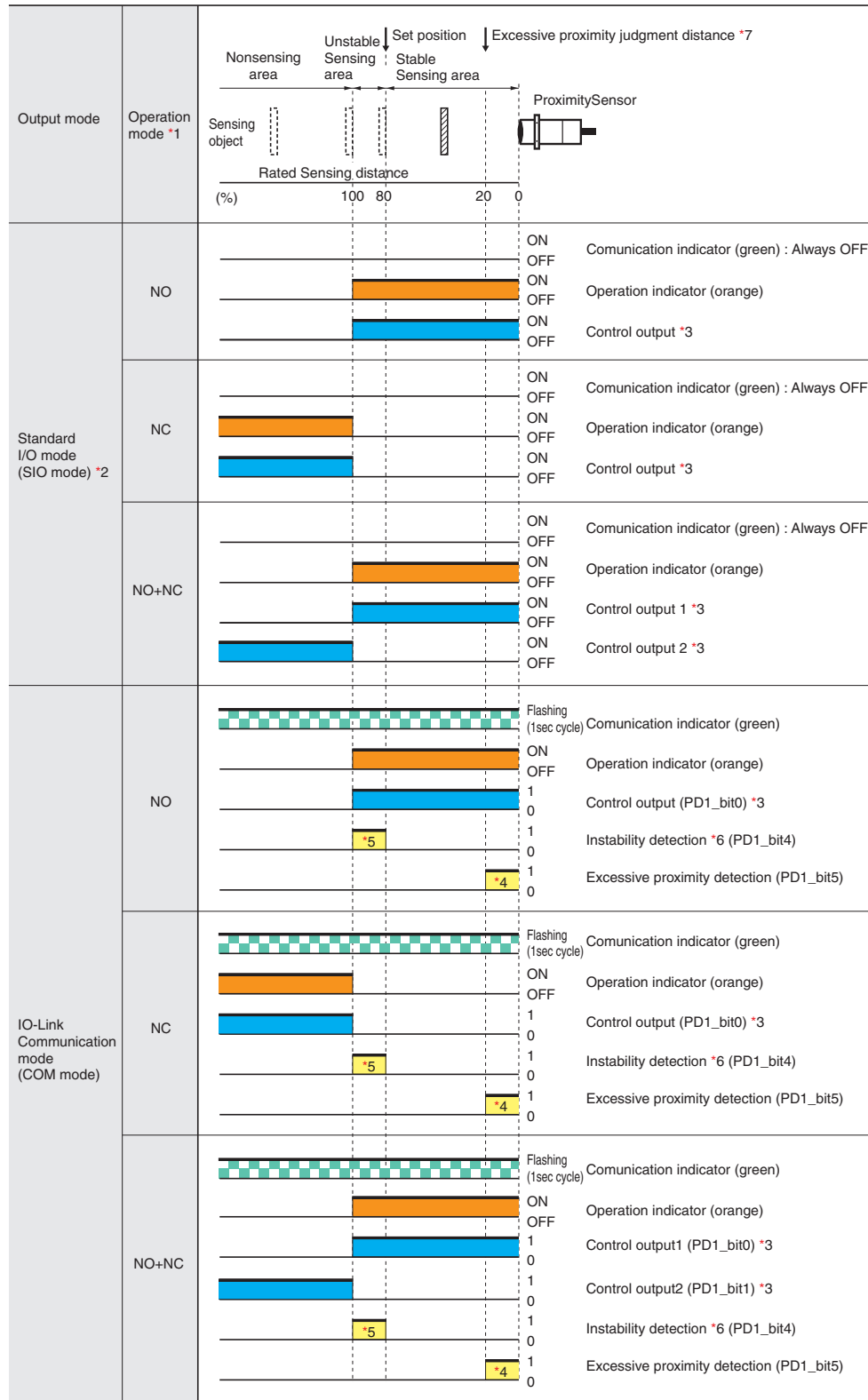

\*3. The timer function of the control output can be set up by the IO-Link communications. (It is able to select ON delay, OFF delay, or one-shot function and select a timer time of 1 to 16,383ms (T).)

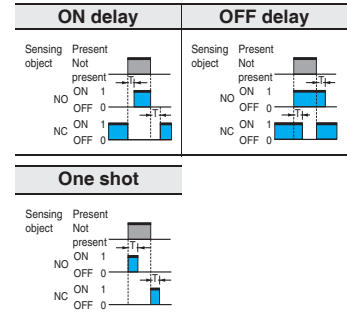

\*4. The excessive proximity diagnosis function can be selected by the IO-Link communications.

\*5. The instability detection diagnosis can be selected by the IO-Link communications.

\*6. The judgment time for the instability detection diagnosis can be selected by the IO-Link communications. (For the ON delay timer function, the setting can be selected from 0 (invalid), 10, 50, 100, 300, 500, or 1000 ms.)

\*7. The judgment distance of the excessive proximity diagnosis function can be selected by the IO-Link communications. (The distance can be selected as a combination of the material of the object detected, such as iron, aluminum, or SUS and the judgment distance of approximately 10, 20, or 30%. However, it is not allowed to select a combination of aluminum and 30%.)

Please contact your OMRON sales representative regarding the IO-Link setup file (IODD file).

Please contact your OMRON sales representative regarding assignment of data.

\*1. For models with IO-Link, the operation mode can be changed by the IO-Link communications.

\*2. If using a model with IO-Link as a general sensor or using a model without IO-Link, it operates in the standard I/O mode (SIO mode).

NPN output

Operation mode	Model	Output circuit
NO	E2E(Q)-□C1	
NC	E2E(Q)-□C2	<p>Note: M8 (3-pin) Connector: (1)(4)(3)</p>
NO+NC	E2E(Q)-□C3	

Connector Pin Arrangement

M12 Connector M12 Smartclick Connector	M8 (4-pin) Connector	M8 (3-pin) Connector

Operation mode	Sensing area		Proximity Sensor	Output	
	Nonsensing area	Stable sensing area		ON/OFF	Output
NO				ON OFF	Operation indicator (orange)
NC				ON OFF	Operation indicator (orange)
NO+NC				ON OFF	Operation indicator (orange)
				ON OFF	Control output 1
				ON OFF	Control output 2

E2E/E2EQ NEXT Series DC 2-wire

E2E/E2EQ NEXT Series DC 3-wire

XS5 NEXT Series

XS5





XS3

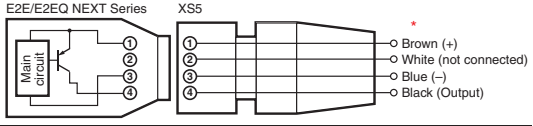
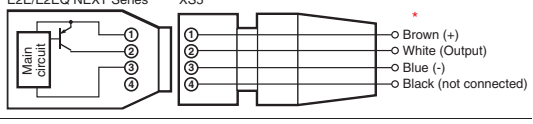
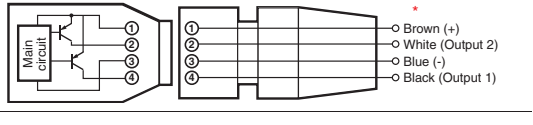
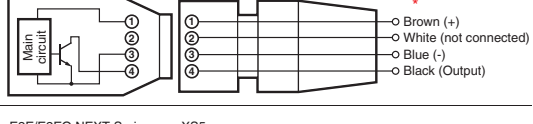
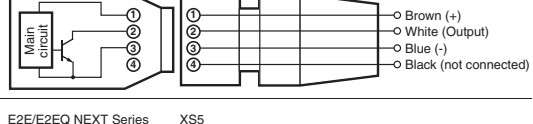
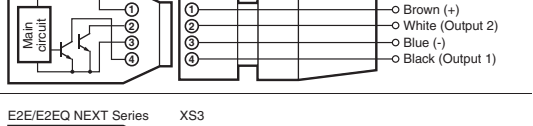
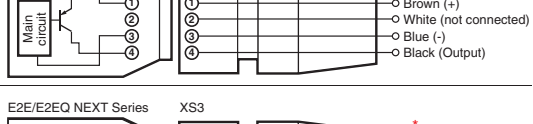
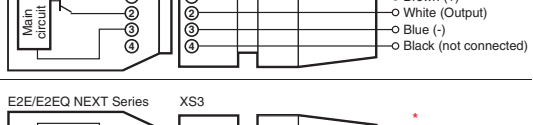
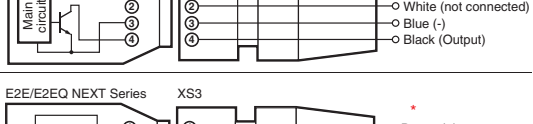
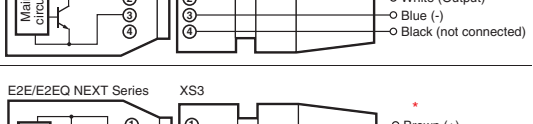
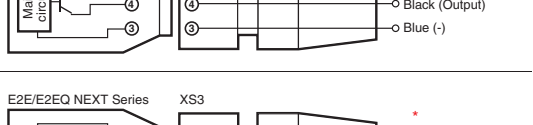

# E2E/E2EQ NEXT Series

## Connections for Sensor I/O Connectors

### DC 3-Wire

Proximity Sensor				Sensor I/O Connectors					
Types	Output	Operation mode	Model	Model	Connections *				
DC 3-Wire (M12 Connector/ M12 Smartclick Connector)	PNP	NO	E2E(Q)-X□B1□-M1TJ/ M1	XS5F-D421-□80-X□ XS5F-D42□-□80-F XS5W-D421-□81-X□ XS5W-D42□-□81-F  <b>Note:</b> For details of the connector, refer to <i>XS5 NEXT Series</i> on page 87 refer to <i>XS5 Series</i> on page 94	E2E/E2EQ NEXT Series XS5 				
		NC	E2E(Q)-X□B2□-M1TJ/M1		E2E/E2EQ NEXT Series XS5 				
		NO+NC	E2E(Q)-X□B3□-M1TJ/M1		E2E/E2EQ NEXT Series XS5 				
		NO	E2E(Q)-X□C1□-M1TJ/M1		E2E/E2EQ NEXT Series XS5 				
		NC	E2E(Q)-X□C2□-M1TJ/M1		E2E/E2EQ NEXT Series XS5 				
		NO+NC	E2E(Q)-X□C3□-M1TJ/M1		E2E/E2EQ NEXT Series XS5 				
	NPN	NO	E2E(Q)-X□B1□-M3		XS3W-M8PVC4□ XS3F-M8PVC4□  <b>Note:</b> For details of the connector, refer to <i>XS3W-M8/ XS3F-M8 Series</i> on page 102.	E2E/E2EQ NEXT Series XS3 			
		NC	E2E(Q)-X□B2□-M3			E2E/E2EQ NEXT Series XS3 			
		NO	E2E(Q)-X□C1□-M3			E2E/E2EQ NEXT Series XS3 			
		NC	E2E(Q)-X□C2□-M3			E2E/E2EQ NEXT Series XS3 			
		DC 3-Wire (M8 Connector, 4-pin)	PNP			NO	E2E(Q)-X□B1□-M5	XS3W-M8PVC3□ XS3F-M8PVC3□  <b>Note:</b> For details of the connector, refer to <i>XS3W-M8/ XS3F-M8 Series</i> on page 102.	E2E/E2EQ NEXT Series XS3 
						NC	E2E(Q)-X□B2□-M5		E2E/E2EQ NEXT Series XS3 
NPN	NO		E2E(Q)-X□C1□-M5	E2E/E2EQ NEXT Series XS3 					
	NC		E2E(Q)-X□C2□-M5	E2E/E2EQ NEXT Series XS3 					

**Note:** Different from Proximity Sensor wire colors.

\* If the XS5W Series or XS3W Series Connector which has a socket and plug on the cable ends is connected to the Sensor, this part will be a plug.



## Safety Precautions



Be sure to read the precautions for all models in the website at: <http://www.ia.omron.com/>.

### Warning Indications

 <b>WARNING</b>	<b>Warning level</b> Indicates a potentially hazardous situation which, if not avoided, will result in minor or moderate injury, or may result in serious injury or death. Additionally there may be significant property damage.
<b>Precautions for Safe Use</b>	Supplementary comments on what to do or avoid doing, to use the product safely.
<b>Precautions for Correct Use</b>	Supplementary comments on what to do or avoid doing, to prevent failure to operate, malfunction or undesirable effect on product performance.

### Meaning of Product Safety Symbols

	<b>General prohibition</b> Indicates the instructions of unspecified prohibited action.
	<b>Caution, explosion</b> Indicates the possibility of explosion under specific conditions.

 <b>WARNING</b>
<p><b>This product is not designed or rated for ensuring safety of persons either directly or indirectly. Do not use it for such purposes.</b></p> <div style="text-align: right;"></div>
<p><b>Otherwise, explosion may result. Never use the product with an AC power supply.</b></p> <div style="text-align: right;"></div>

### Precautions for Safe Use

The following precautions must be observed to ensure safe operation.

1. Do not use the product in environments subject to flammable or explosive gases.
2. Do not attempt to disassemble, repair, or modify the product.
3. Do not use a voltage that exceeds the rated operating voltage range.  
Applying a voltage that is higher than the operating voltage range may result in explosion or fire.
4. Be sure that the power supply polarity and other wiring is correct. Incorrect wiring may cause explosion or fire.
5. If the power supply is connected directly without a load, the internal elements may explode or burn.
6. Be sure to insert a load when connecting the power supply.

### Precautions for Correct Use

Do not use the product in any atmosphere or environment that exceeds the ratings.

#### Operating Environment

1. Do not install the Sensor in the following locations.
  - (1) Outdoor locations directly subject to sunlight, rain, snow, water droplets, or oil.
  - (2) Locations subject to atmospheres with chemical vapors, in particular solvents and acids.
  - (3) Locations subject to corrosive gases.
2. The Sensor may malfunction if used near ultrasonic cleaning equipment, high-frequency equipment, transceivers, cellular phones, inverters, or other devices that generate a high-frequency electric field. Please refer to the Precautions for Correct Use on the OMRON website ([www.ia.omron.com](http://www.ia.omron.com)) for typical measures.
3. Laying the Proximity Sensor wiring in the same conduit or duct as high-voltage wires or power lines may result in incorrect operation and damage due to induction. Wire the Sensor using a separate conduit or independent conduit.
4. Never use thinner or other solvents. Otherwise, the Sensor surface may be dissolved.
5. The following conditions shall be observed if you use the product under an environment using cutting oil that may affect product's life and/or performance.
  - Usage under the cutting oil condition designated by the specification
  - Usage under the cutting oil dilution ratio recommended by its manufacturer
  - Usage in oil or water is prohibited
 Impact on the product life may differ depending on the oil you use. Before using the cutting oil, make sure that it should not cause deterioration or degradation of sealing components.
6. When turning on the power by influence of temperature environment, an output mis-pulse sometimes occurs. After the sensor has passed for 300 msec after turning on, please use in the stable state.
7. The sensor is adjusted with a high degree of accuracy, so do not use in the environment with sudden temperature change.
8. Operation check is performed using an OMRON's IO-Link master. If using an IO-Link master from another company, perform the operation check in advance.

# E2E/E2EQ NEXT Series

## Design

### Influence of Surrounding Metal

When mounting the Proximity Sensor using a nut, only use the provided nut. And ensure that the minimum distances given in the following table are maintained.

When mounting the Proximity Sensor using a nut, only use the provided nut. Nuts that are supplied along with each Sensor are different. Refer to Dimensions for details on shapes.

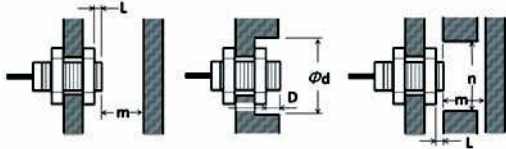

(Unit: mm)

### Shielded

Type	Model	L	d	D	m	n
Quadruple distance model	E2E-X4□8	3	30	3	12	20
	E2E-X9□12	2	40	2	27	30
	E2E-X14□18	2	60	2	42	70
	E2E-X23□30	2	100	2	69	100
Triple distance model/ Spatter-resistant Triple distance model	E2E(Q)-X3□8	0	20	0	9	18
	E2E(Q)-X6□12	0	20	0	18	20
	E2E(Q)-X12□18	0	50	0	36	54
	E2E(Q)-X22□30	0	70	0	66	90
Double distance model/ Spatter-resistant Double distance model	E2E(Q)-X2□8	0	8	0	4.5	12
	E2E(Q)-X4□12	0	18	0	12	18
	E2E(Q)-X8□18	0	27	0	24	27
	E2E(Q)-X15□30	0	45	0	45	45
Single distance model/ Spatter-resistant Single distance model	E2E(Q)-X1R5□8	0	8	0	4.5	12
	E2E(Q)-X2□12	0	12	0	8	18
	E2E(Q)-X5□18	0	18	0	20	27
	E2E(Q)-X10□30	0	30	0	40	45

### Unshielded

Models	Model	L	d	D	m	n
Quadruple distance model	E2E-X8M□8	12	40	12	24	40
	E2E-X16M□12	21	70	21	48	80
	E2E-X30M□18	46	130	46	90	110
	E2E-X50M□30	60	200	60	150	180
Triple distance model	E2E-X6M□8	10	30	10	18	30
	E2E-X10M□12	16	50	16	30	50
	E2E-X20M□18	31	90	31	60	80
	E2E-X40M□30 *	50	170	50	120	140
Double distance model	E2E-X4M□8	9	24	9	8	24
	E2E-X8M□12	11	40	11	20	40
	E2E-X16M□18	21	70	21	48	70
	E2E-X30M□30	40	120	40	90	120
Single distance model	E2E-X2M□8	6	24	6	8	24
	E2E-X5M□12	11	40	11	20	36
	E2E-X10M□18	18	55	18	40	54
	E2E-X18M□30	25	90	25	70	90

\* If you use the model E2E-X40M□30, the panel thickness (t) is 4 mm or less.

When the Proximity Sensor is mounted in metal, ensure that the minimum distances given in the following table are maintained.

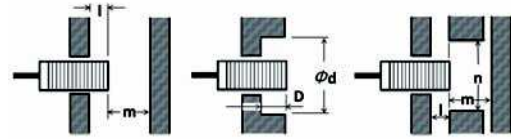

(Unit: mm)

### Shielded

Models	Model	l	d	D	m	n
Quadruple distance model	E2E-X4□8	4	30	4	12	20
	E2E-X9□12	6	40	6	27	30
	E2E-X14□18	7	60	7	42	70
	E2E-X23□30	9	100	9	69	100
Triple distance model/ Spatter-resistant Triple distance model	E2E(Q)-X3□8	2	20	2	9	18
	E2E(Q)-X6□12	4	20	4	18	20
	E2E(Q)-X12□18	4	50	4	36	54
	E2E(Q)-X22□30	8	70	8	66	90
Double distance model/ Spatter-resistant Double distance model	E2E(Q)-X2□8	0	8	0	4.5	12
	E2E(Q)-X4□12	2.4	18	2.4	12	18
	E2E(Q)-X8□18	3.6	27	3.6	24	27
	E2E(Q)-X15□30	6	45	6	45	45
Single distance model/ Spatter-resistant Single distance model	E2E(Q)-X1R5□8	0	8	0	4.5	12
	E2E(Q)-X2□12	0	12	0	8	18
	E2E(Q)-X5□18	0	18	0	20	27
	E2E(Q)-X10□30	0	30	0	40	45

### Unshielded

Models	Model	l	d	D	m	n
Quadruple distance model	E2E-X8M□8	15	40	15	24	40
	E2E-X16M□12	25	70	25	48	80
	E2E-X30M□18	50	130	50	90	110
	E2E-X50M□30	65	200	65	150	180
Triple distance model	E2E-X6M□8	13	30	13	18	30
	E2E-X10M□12	20	50	20	30	50
	E2E-X20M□18	35	90	35	60	80
	E2E-X40M□30 *	55	170	55	120	140
Double distance model	E2E-X4M□8	12	24	12	8	24
	E2E-X8M□12	15	40	15	20	40
	E2E-X16M□18	25	70	25	48	70
	E2E-X30M□30	45	120	45	90	120
Single distance model	E2E-X2M□8	6	24	6	8	24
	E2E-X5M□12	15	40	15	20	36
	E2E-X10M□18	22	55	22	40	54
	E2E-X18M□30	30	90	30	70	90

\* If you use the model E2E-X40M□30, the panel thickness (t) is 4 mm or less.

**Mutual Interference**

When installing two or more Proximity Sensors face-to-face or side-by-side, ensure that the minimum distances given in the following table are maintained.

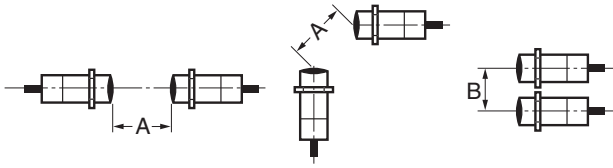

(Unit: mm)

**Shielded**

Models	Model	Item	
		A	B
Quadruple distance model	E2E-X4□8	40	20
	E2E-X9□12	60	35
	E2E-X14□18	90	50
	E2E-X23□30	150	90
Triple distance model/ Spatter-resistant Triple distance model	E2E(Q)-X3□8	25	20
	E2E(Q)-X6□12	40	30
	E2E(Q)-X12□18	70	45
	E2E(Q)-X22□30	150	90
Double distance model/ Spatter-resistant Double distance model	E2E(Q)-X2□8	20	15
	E2E(Q)-X4□12	30	20
	E2E(Q)-X8□18	60	35
	E2E(Q)-X15□30	110	90
Single distance model/ Spatter-resistant Single distance model	E2E(Q)-X1R5□8	20	15
	E2E(Q)-X2□12	30	20
	E2E(Q)-X5□18	50	35
	E2E(Q)-X10□30	100	70

**Unshielded**

Models	Model	Item	
		A	B
Quadruple distance model	E2E-X8M□8	80	60
	E2E-X16M□12	160	120
	E2E-X30M□18	360	300
	E2E-X50M□30	700	480
Triple distance model	E2E-X6M□8	80	60
	E2E-X10M□12	120	100
	E2E-X20M□18	200	120
	E2E-X40M□30	380	300
Double distance model	E2E-X4M□8	80	60
	E2E-X8M□12	120	100
	E2E-X16M□18	200	120
	E2E-X30M□30	350	300
Single distance model	E2E-X2M□8	80	60
	E2E-X5M□12	120	100
	E2E-X10M□18	200	110
	E2E-X18M□30	300	200

**Mounting**

**Tightening Force**

Do not tighten the nut with excessive force. A washer must be used with the nut.

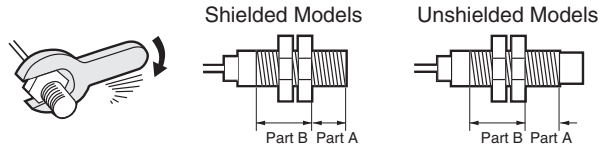

- Note:**
- The allowable tightening strength depends on the distance from the edge of the head, as shown in the following table. (A is the distance from the edge of the head. B includes the nut on the head side. If the edge of the nut is in part A, the tightening torque for part A applies instead.)
  - The following strengths assume washers are being used.

**Quadruple distance model, Triple distance model, Spatter-resistant Triple distance model**

Size	Shielded	Part A		Part B
		Dimension (mm)	Torque	Torque
M8	Shielded	9	4 N·m	10 N·m
	Unshielded	3		
M12	Shielded	16	6 N·m	15 N·m
	Unshielded	9		
M18	Shielded	16	15 N·m	60 N·m (30 N·m *)
	Unshielded	3		
M30	Shielded	23	40 N·m	80 N·m
	Unshielded	8		

\* If using the E2EQ (M18), refer to this torque value.

**Double distance model, Single distance model, Spatter-resistant Triple distance model, Spatter-resistant Single distance model**

Size	Shielded	Part A		Part B
		Dimension (mm)	Torque	Torque
M8	Shielded	9	9 N·m	12 N·m
	Unshielded	3		
M12	---	---	30 N·m	
M18	---	---	70 N·m	
M30	---	---	180 N·m (100 N·m *)	

\* If using the E2EQ (M30), refer to this torque value.

**Mounting**

In the IO-Link mode, the cord between the IO-Link master and sensor must have a length of 20 m or less.

# E2E/E2EQ NEXT Series

## Dimensions

(Unit: mm)

Tolerance class IT16 applies to dimensions in this data sheet unless otherwise specified.

### Sensors

**PREMIUM Model**

## E2E/E2EQ NEXT Series

(Quadruple distance/Triple distance/Spatter-resistant, Triple distance model)

DC 3-Wire

Pre-wired Model/Pre-wired Connector Model  
Shielded/Unshielded

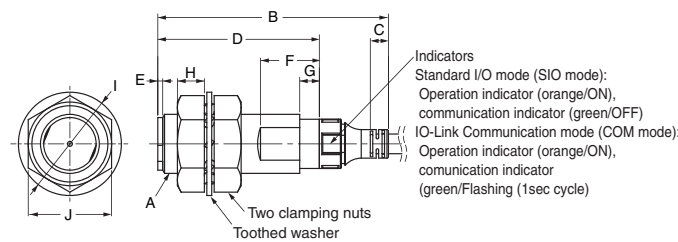

#### Pre-wired Models

(Operation mode: NO, NC Type)

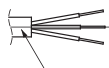

Vinyl-insulated round cable with  
3 conductors  
M8, M12 size: 4-dia.  
M18, M30 size: 6-dia.  
(Conductor cross section:  
0.2 mm<sup>2</sup> (AWG24),  
Insulator diameter: 1.05 mm),  
Standard length: 2 m

(Operation mode: NO+NC Type)

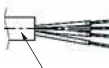

Vinyl-insulated round cable with  
4 conductors  
M12 size: 4.3-dia.  
M18/M30 size: 6-dia.  
(Conductor cross section: 0.2 mm<sup>2</sup>  
(AWG24),  
Insulator diameter: 1.05 mm),  
Standard length: 2 m

#### Pre-wired Connector Models (M12J)

(Operation mode: NO, NC Type)

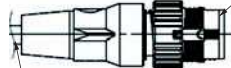

Vinyl-insulated round cable with  
3 conductors  
M8, M12 size: 4-dia.  
M18, M30 size: 6-dia.  
(Conductor cross section:  
0.2 mm<sup>2</sup> (AWG24),  
Insulator diameter: 1.05 mm),  
Standard length: 0.3 m

(Operation mode: NO+NC Type)  
Vinyl-insulated round cable with  
4 conductors  
M12 size: 4.3-dia.  
M18, M30 size: 6-dia.  
(Conductor cross section: 0.2 mm<sup>2</sup>  
(AWG24),  
Insulator diameter: 1.05 mm),  
Standard length: 0.3 m

### Connector Models

(M12 Connector, M8 (4-pin) Connector and M8 (3-pin) Connector)  
Shielded/Unshielded

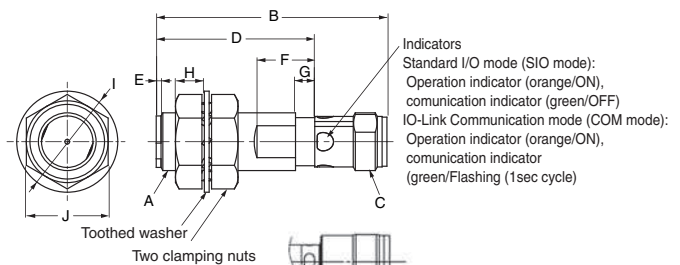

Model E2E(Q)-X□8-M1;  
Shape of connection.

#### Shielded

Model	A	B	C	D	E	F	G*	H	I	J
E2E(Q)-X□8-M3/M5	M8XP1	39	M8XP1	26	1	10	4	4	15	13
E2E(Q)-X□8-M1	M8XP1	43	M12XP1	26	1	10	4	4	15	13
E2E(Q)-X□12-M1	M12XP1	48	M12XP1	33	1	12	4	5.5	21	17
E2E(Q)-X□18-M1	M18XP1	53	M12XP1	38	1	12	4	6	29	24
E2E(Q)-X□30-M1	M30XP1.5	58	M12XP1	43	1	12	4	7	42	36
E2E-X□L8-M3/M5	M8XP1	49	M8XP1	36	1	10	---	4	15	13
E2E-X□L8-M1	M8XP1	53	M12XP1	36	1	10	---	4	15	13
E2E-X□L12-M1	M12XP1	70	M12XP1	55	1	12	---	5.5	21	17
E2E-X□L18-M1	M18XP1	75	M12XP1	60	1	12	---	6	29	24
E2E-X□L30-M1	M30XP1.5	80	M12XP1	65	1	12	---	7	42	36

#### Unshielded

Model	A	B	C	D	E	F	G*	H	I	J
E2E-X□M□8-M3/M5	M8XP1	39	M8XP1	26	6	8	---	3	15	13
E2E-X□M□8-M1	M8XP1	43	M12XP1	26	6	8	---	3	15	13
E2E-X□M□12-M1	M12XP1	48	M12XP1	33	7	10	---	4	21	17
E2E-X□M□L8-M3/M5	M8XP1	49	M8XP1	36	6	8	---	3	15	13
E2E-X□M□L8-M1	M8XP1	53	M12XP1	36	6	8	---	3	15	13
E2E-X□M□L12-M1	M12XP1	70	M12XP1	55	7	10	---	4	21	17
E2E-X□M□L18-M1	M18XP1	75	M12XP1	60	13	12	---	4	29	24
E2E-X40M□L30-M1	M30XP1.5	80	M12XP1	65	15	10	---	5	42	36
E2E-X50M□L30-M1	M30XP1.5	95	M12XP1	80	15	12	---	5	42	36

\* Mounting part of sensor lock O-ring (Y92E-J□S□) ---: Out of a subject.

#### Shielded

Model	A	B	C	D	E	F	G*	H	I	J
E2E(Q)-X□8	M8XP1	37.8	4.4	26	1	10	4	4	15	13
E2E(Q)-X□12	M12XP1	47.1	3.7	33	1	12	4	5.5	21	17
E2E(Q)-X□18	M18XP1	55.3	8.5	38	1	12	4	6	29	24
E2E(Q)-X□30	M30XP1.5	60.3	8.3	43	1	12	4	7	42	36
E2E-X□L8	M8XP1	47.8	4.4	36	1	10	---	4	15	13
E2E-X□L12	M12XP1	69.1	3.7	55	1	12	---	5.5	21	17
E2E-X□L18	M18XP1	77.3	8.5	60	1	12	---	6	29	24
E2E-X□L30	M30XP1.5	82.3	8.3	65	1	12	---	7	42	36

#### Unshielded

Model	A	B	C	D	E	F	G*	H	I	J
E2E-X□M□8	M8XP1	37.8	4.4	26	6	8	---	3	15	13
E2E-X□M□12	M12XP1	47.1	3.7	33	7	10	---	4	21	17
E2E-X□M□L8	M8XP1	47.8	4.4	36	6	8	---	3	15	13
E2E-X□M□L12	M12XP1	69.1	3.7	55	7	10	---	4	21	17
E2E-X□M□L18	M18XP1	77.3	8.5	60	13	12	---	4	29	24
E2E-S05S12□	M30XP1.5	82.3	8.3	65	15	10	---	5	42	36
E2E-S05S12□	M30X1.5	97.3	8.3	80	15	12	---	5	42	36

\* Mounting part of sensor lock O-ring (Y92E-J□S□) ---: Out of a subject.

#### Mounting Hole Dimensions



Dimensions	F (mm)
M8	8.5 dia. <sup>+0.5</sup> / <sub>0</sub>
M12	12.5 dia. <sup>+0.5</sup> / <sub>0</sub>
M18	18.5 dia. <sup>+0.5</sup> / <sub>0</sub>
M30	30.5 dia. <sup>+0.5</sup> / <sub>0</sub>

#### Angle R of the Bending Wire

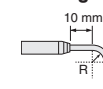

Dimensions	R (mm)
M8	12
M12	12
M18	18
M30	18

#### Wire pullout position

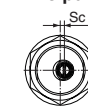

Dimensions	Sc (mm)
M8	- (0)
M12	- (0)
M18	2.5
M30	2.5



BASIC Model

E2E/E2EQ NEXT Series

(Double distance/Single distance/Spatter-resistant, Double distance/Single distance model)

DC 3-Wire

Pre-wired Model/Pre-wired Connector Model  
Shielded/Unshielded

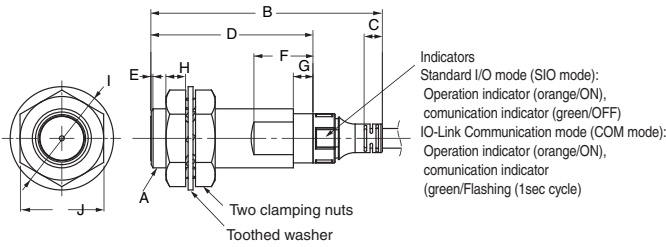

Pre-wired Models  
(Operation mode: NO, NC Type)

Pre-wired Connector Models (M1TJ)  
M12xP1

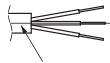

Vinyl-insulated round cable with 3 conductors  
M8, M12 size: 4-dia.  
M18, M30 size: 6-dia.  
(Conductor cross section:  
0.2 mm<sup>2</sup> (AWG24),  
Insulator diameter: 1.05 mm),  
Standard length: 2 m

(Operation mode: NO+NC Type)



Vinyl-insulated round cable with 4 conductors  
M12 size: 4.3-dia.  
M18, M30 size: 6-dia.  
(Conductor cross section: 0.2 mm<sup>2</sup> (AWG24),  
Insulator diameter: 1.05 mm),  
Standard length: 2 m



(Operation mode: NO, NC Type)  
Vinyl-insulated round cable with 3 conductors  
M8, M12 size: 4-dia.  
M18, M30 size: 6-dia.  
(Conductor cross section:  
0.2 mm<sup>2</sup> (AWG24),  
Insulator diameter: 1.05 mm),  
Standard length: 0.3 m

(Operation mode: NO+NC Type)  
Vinyl-insulated round cable with 4 conductors  
M12 size: 4.3-dia.  
M18, M30 size: 6-dia.  
(Conductor cross section: 0.2 mm<sup>2</sup> (AWG24),  
Insulator diameter: 1.05 mm),  
Standard length: 0.3 m

Shielded

Model	A	B	C	D	E	F*1	G*2	H	I	J
E2E(Q)-X□8	M8XP1	37.8	4.4	26	---	10 (8)	4	3	15	13
E2E(Q)-X□12	M12XP1	47.1	3.7	33	---	12 (10)	4	4	21	17
E2E(Q)-X□18	M18XP1	55.3	8.5	38	---	12 (10)	4	4	29	24
E2E(Q)-X□30	M30XP1.5	60.3	8.3	43	---	12 (10)	4	5	42	36
E2E-X□L8	M8XP1	47.8	4.4	36	---	8	---	3	15	13
E2E-X□L12	M12XP1	69.1	3.7	55	---	10	---	4	21	17
E2E-X□L18	M18XP1	77.3	8.5	60	---	10	---	4	29	24
E2E-X□L30	M30XP1.5	82.3	8.3	65	---	10	---	5	42	36

Unshielded

Model	A	B	C	D	E*3	F	G*2	H	I	J
E2E-X□M□8	M8XP1	37.8	4.4	26	6	8	---	3	15	13
E2E-X□M□12	M12XP1	47.1	3.7	33	7	10	---	4	21	17
E2E-X□M□18	M18XP1	55.3	8.5	38	10	10	---	4	29	24
E2E-X□M□30	M30XP1.5	60.3	8.3	43	13	10	---	5	42	36
E2E-X□M□L8	M8XP1	47.8	4.4	36	6	8	---	3	15	13
E2E-X□M□L12	M12XP1	69.1	3.7	55	7	10	---	4	21	17
E2E-X□M□L18	M18XP1	77.3	8.5	60	10	10	---	4	29	24
E2E-X□M□L30	M30XP1.5	82.3	8.3	65	130 (15)	10	---	5	42	36

\*1. If using the E2EQ, refer to ( ) dimensions.

\*2. Mounting part of sensor lock O-ring (Y92E-J□S□) ---: Out of a subject.

\*3. When using X30M□30, refer to (15).

Connector Models  
(M12 Connector, M8 (4-pin) Connector and M8 (3-pin) Connector)  
Shielded/Unshielded

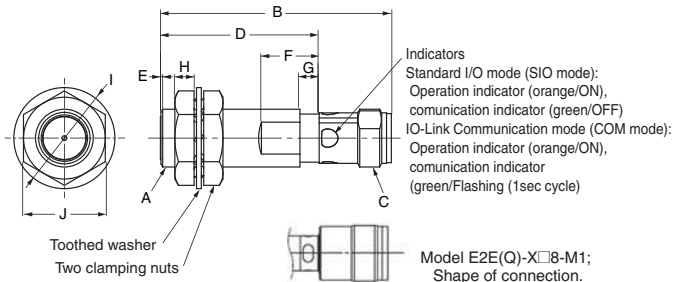

Shielded

Model	A	B	C	D	E	F*1	G*2	H	I	J
E2E(Q)-X□30 X□8-M3/M5	M8XP1	39	M8XP1	26	---	10 (8)	4	3	15	13
E2E(Q)-X□8-M1	M8XP1	43	M12XP1	26	---	10 (8)	4	3	15	13
E2E(Q)-X□12-M1	M12XP1	48	M12XP1	33	---	12 (10)	4	4	21	17
E2E(Q)-X□18-M1	M18XP1	53	M12XP1	38	---	12 (10)	4	4	29	24
E2E(Q)-X□30-M1	M30XP1.5	58	M12XP1	43	---	12 (10)	4	5	42	36
E2E-X□L8-M3/M5	M8XP1	49	M8XP1	36	---	8	---	3	15	13
E2E-X□L8-M1	M8XP1	53	M12XP1	36	---	8	---	3	15	13
E2E-X□L12-M1	M12XP1	70	M12XP1	55	---	10	---	4	21	17
E2E-X□L18-M1	M18XP1	75	M12XP1	60	---	10	---	4	29	24
E2E-X□L30-M1	M30XP1.5	80	M12XP1	65	---	10	---	5	42	36

Unshielded

Model	A	B	C	D	E*3	F	G*2	H	I	J
E2E-X□M□8-M3/M5	M8XP1	39	M8XP1	26	6	8	---	3	15	13
E2E-X□M□8-M1	M8XP1	43	M12XP1	26	6	8	---	3	15	13
E2E-X□M□12-M1	M12XP1	48	M12XP1	26	7	10	---	4	21	17
E2E-X□M□18-M1	M18XP1	53	M12XP1	38	10	10	---	4	29	24
E2E-X□M□30-M1	M30XP1.5	58	M12XP1	43	13	10	---	5	42	36
E2E-X□M□L8-M3-M5	M8XP1	49	M8XP1	36	6	8	---	3	15	13
E2E-X□M□L8-M1	M8XP1	53	M12XP1	36	6	8	---	3	15	13
E2E-X□M□L12-M1	M12XP1	70	M12XP1	55	7	10	---	4	21	17
E2EX□M□L18-M1	M18XP1	75	M12XP1	60	10	10	---	4	29	24
E2E-X□M□L30-M1	M30XP1.5	80	M12XP1	65	130 (15)	10	---	5	42	36

\*1. If using the E2EQ, refer to ( ) dimensions.

\*2. Mounting part of sensor lock O-ring (Y92E-J□S□) ---: Out of a subject.

\*3. When using X30M□30, refer to (15).

Mounting Hole Dimensions



Dimensions	F (mm)
M8	8.5 dia. <sup>+0.5</sup> / <sub>0</sub>
M12	12.5 dia. <sup>+0.5</sup> / <sub>0</sub>
M18	18.5 dia. <sup>+0.5</sup> / <sub>0</sub>
M30	30.5 dia. <sup>+0.5</sup> / <sub>0</sub>

Angle R of the Bending Wire

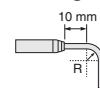

Dimensions	R (mm)
M8	12
M12	12
M18	18
M30	18

Wire pullout position

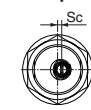

Dimensions	Sc (mm)
M8	- (0)
M12	- (0)
M18	2.5
M30	2.5

## Accessories (Sold Separately)

### e-jig (Mounting Sleeves)

#### Y92E-J8S12

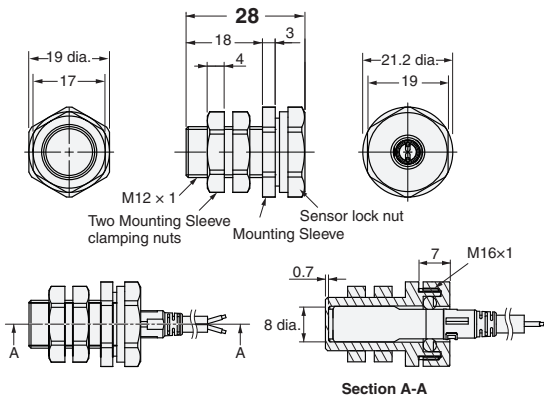

#### Y92E-J12S18

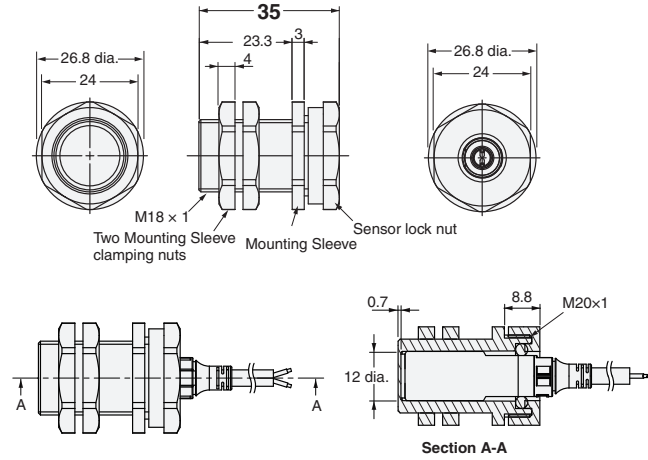

#### Y92E-J18S30

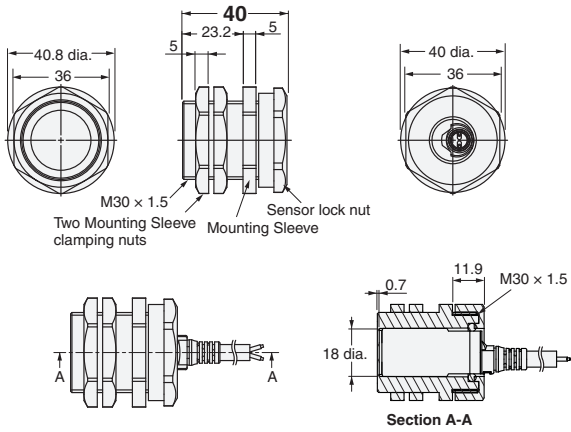

### Material

Mounting Sleeve	Polyetheretherketone (PEEK) / Polybutylene terephthalate (PBT)
Mounting Sleeve clamping nut	Polybutylene terephthalate (PBT)
Sensor lock nut	Polybutylene terephthalate (PBT)
Sensor lock O-ring	Material combining HNBR and fluororubber

### Tightening Force

Model	Torque	
	Mounting Sleeve clamping nut	Sensor lock nut
Y92E-J8S12	0.6 N·m	0.6 N·m
Y92E-J12S18	1.2 N·m	1.2 N·m
Y92E-J18S30	5 N·m	3.5 N·m



# XS5 NEXT Series

## Round Oil-resistive Smartclick Connectors for E2E NEXT Series proximity sensors, that are Resistant to Oil, and that Reduce Installation Work

- Uses unique OMRON technology\*1 and the same PVC cable with increased oil resistance as the E2E NEXT Series proximity sensors. Oil-resistance performance values of 2 years\*2 when used in combination with E2E NEXT Series proximity sensors.
- Oil-resistant robot cables for use with moving parts such as loaders and cableveyors **NEW**
- OMRON's unique lock mechanism (Smartclick) that is compatible with round M12 connectors.
- Simply insert the Connectors, then turn them approximately 1/8 of a turn to lock.
- A positive click indicates locking.
- IP67, IP69K degree of protection.
- UL approved products.

\*1. Patent pending (as of July, 2018)

\*2. Covered types of oil: Cutting oil specified in JIS K 2241:2000

The oil-resistance performance value (2 years) indicates the median value (=Typ) at product design, and in evaluation testing results of oil-resistance performance. Shipped products will show some variance around this 2 year value in actual usage.



For the most recent information on models that have been certified for safety standards, refer to your OMRON website.

## Features

### Better Cable Oil Resistance, and Improved Overall Oil Resistance with New Rubber Material in Mating Sections

The XS5 NEXT Series uses a special PVC cable that limits deterioration of the cable sheath due to both water-soluble and water-insoluble cutting oil. Omron's proprietary molding technique prevents cutting oil intrusion from mating sections. Moreover, using the same new HNBR/fluoride rubber as in oil-resistant components of connector mating sections helps improve the overall oil resistance.

#### Special PVC Cable + Molding Sealing Method

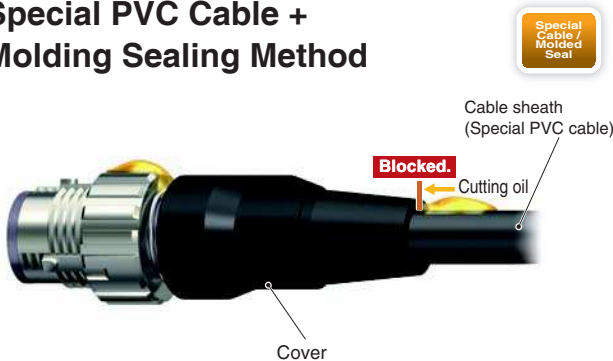

#### Smartclick Structure + O-ring

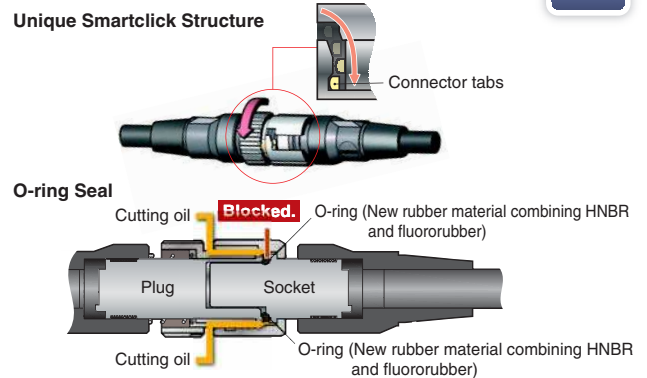

Patented

#### New Rubber Material Combining and Fluororubber

Hydrogenated nitrile butadiene rubber (HNBR), which provides superior resistance to oil, was blended with fluororubber in a unique OMRON compound to develop a new rubber that provides superior resistance to both swelling and deterioration due to cutting oil. It is used in seals for joints and moving sections that prevent ingress to prevent deterioration and destruction of the seal due to cutting oil, resulting in increased oil resistance performance.

This new material combines the benefits of HNBR and fluororubber

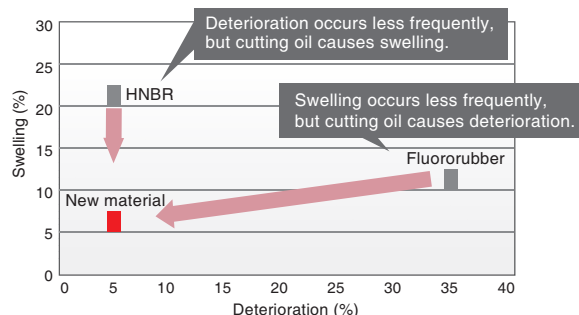

## P67G quality and Omron's Oil Resistance Component Evaluation System for two years of proven oil resistant capability

Oil resistance: **2 years\***

IP67G	
Oil type	N3 (water-insoluble cutting oil)
Evaluation time	48 hours
Evaluation temperature	Room temperature
Dilution concentration	---
Criteria	Appearance and performance



(Illustration)

OMRON's Oil-resistant Component Evaluation Standards	
Oil type	A1 (water-soluble cutting oil)
Evaluation time	1,000 hours of machining
Evaluation temperature	55 °C
Dilution concentration	Undiluted
Criteria	Appearance, performance, and no label text loss



(Illustration)

\* Applicable oil types: specified in JIS K 2241:2000

"2-year oil resistance" refers to median values (=Typical values) of the product designs and the oil-resistance performance evaluation results. Products to be shipped will have around 2 years of oil resistance; actual oil resistance will vary depending on the product.

### Varied product lineup to suit the application

Fixed Parts XS5□-D421-□8□-X

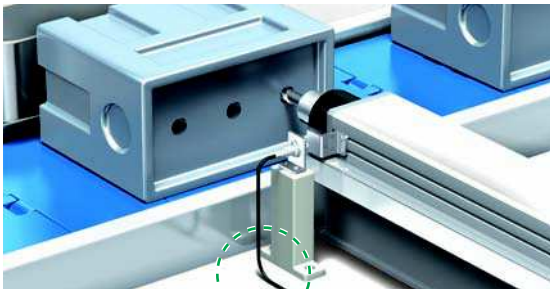

Fixed installation

Moving Parts XS5□-D421-□8□-XR **NEW**



Installation with moving parts such as loaders and cableveyors

## Model Number Structure

### Model Number Legend

Use this legend when determining the product specifications from the model number. When ordering, use a model number from the table in **Ordering Information**.

**XS5** □ - **D** 4 2 1 - □ **8** □ - **X** □

1    2    3    4    5        6    7    8                    9

**1. Type**

W: Connectors connected to cable, socket and plug on cable ends  
F: Connectors connected to cable, socket on one cable end

**2. Mating Section Form**

D: A-coding (for DC sensor)

**3. Connector Poles**

4: 4 poles

**4. Contact Plating**

2: Gold plating

**5. Cable Connection Direction**

XS5W 1: Straight (Socket)/Straight (Plug)  
XS5F 1: Straight

**6. Cable Length**

C: 1 m  
D: 2 m  
E: 3 m  
G: 5 m  
J: 10 m

**7. Connections (Numbers inside circles are terminal numbers)**

8: ① Brown, ② White, ③ Blue, ④ Black

**8. Connectors on One End/Both Ends**

0: Sockets on One Cable End  
1: Socket and Plug on Cable Ends

**9. Cable Specifications**

X: Oil-resistant PVC cable  
XR: Oil-resistant PVC robot cable

Smartclick is registered trademark of OMRON Corporation.

## Ordering Information

### Connectors

Type	Cable outer diameter (mm)	Cable specifications	Cable length (m)	Model	UL
Socket and Plug on Cable Ends	6 dia.	Oil-resistant PVC cable	1	XS5W-D421-C81-X	UL2238 certified (File no. E207683)
			2	XS5W-D421-D81-X	
			3	XS5W-D421-E81-X	
			5	XS5W-D421-G81-X	
			10	XS5W-D421-J81-X	
	6 dia.	Oil-resistant PVC robot cable	1	XS5W-D421-C81-XR	
			2	XS5W-D421-D81-XR	
			3	XS5W-D421-E81-XR	
			5	XS5W-D421-G81-XR	
			10	XS5W-D421-J81-XR	
Sockets on One Cable End	6 dia.	Oil-resistant PVC cable	1	XS5F-D421-C80-X	
			2	XS5F-D421-D80-X	
			3	XS5F-D421-E80-X	
			5	XS5F-D421-G80-X	
			10	XS5F-D421-J80-X	
	6 dia.	Oil-resistant PVC robot cable	1	XS5F-D421-C80-XR	
			2	XS5F-D421-D80-XR	
			3	XS5F-D421-E80-XR	
			5	XS5F-D421-G80-XR	
			10	XS5F-D421-J80-XR	

### Accessories (Sold Separately)

#### Connector Covers

##### Water-resistant Covers

Model	Material	Suitable connector		Remarks
		Model	Mounting portion	
XS2Z-11	Brass/nickel plated	XS5W	M12 male screw	This provides IP67 levels of protection. When mounting the Water-resistant Cover to a Connector, be sure to apply a torque range between 0.39 and 0.49 N·m to tighten the Water-resistant Cover.
XS5Z-11	PBT	XS5F/XS5W	M12 female screw	This provides IP67 levels of protection. This uses the Smart click mechanism. There's no need to keep track of locking torque.

##### Water-resistant Covers

###### XS2Z-11

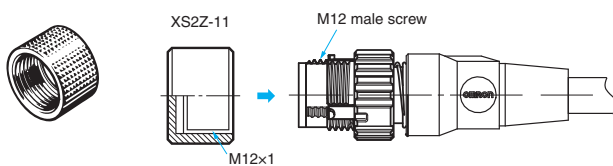

###### XS5Z-11

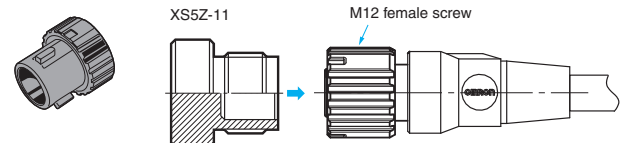

##### Dust Covers

Model	Material	Suitable connector		Remarks
		Model	Mounting portion	
XS2Z-13	Rubber/black	XS5W	M12 male screw	The Dust Cover is for dust prevention and does not ensure IP67 degree of protection. When mounting the Dust Cover to a connector, be sure to press the Dust Cover onto the Connector until the Connector is fully inserted into the Dust Cover.
XS2Z-14		XS5F/XS5W	Contact blocks (female contact)	
XS2Z-15			M12 female screw	

##### Dust Covers

###### XS2Z-13

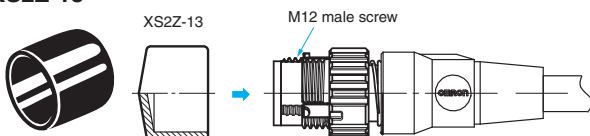

###### XS2Z-15/XS2Z-14

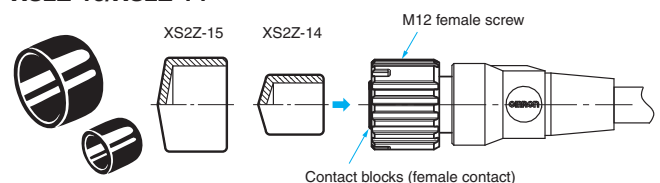

# XS5 NEXT Series

## Ratings and Specifications

Rated current	4 A
Rated voltage	250 VDC
Contact resistance (connector)	40 mΩ max. (at 20 mV max., 100 mA max.)
Insulation resistance	1,000 MΩ min. (at 500 VDC) *1
Dielectric strength (connector)	1,500 VAC for 1 minute (leakage current: 1 mA max.)
Degree of protection	IP67 (IEC60529) IP69K (ISO20653 (formerly DIN Standard 40050 PART9)) OMRON's Oil-resistant Component Evaluation Standards *2 (Cutting oil type JIS K 2241:2000-specification cutting oil, at 35°C or below)
Insertion tolerance	50 times
Lock strength	Tensile: 100 N/15 s, Torsion: 1 N·m/15 s
Cable holding strength	Tensile: 100 N/15 s, Torsion: 1 N·m/15 s
Lock operating force	0.1 to 0.25 N·m
Ambient operating temperature range	-25 to +70°C *3
Ambient humidity range	20 to 85%RH

\*1. State at shipping.

\*2. "OMRON's Oil-resistant Component Evaluation Standards" are OMRON's own durability evaluation standards.

Protection performance with oil-resistive connector (XS5F/W-X) correctly mated.

This performance does not apply if an oil-resistive connector (XS5F/W-X) is missing, and cord wiring is exposed.

\*3. Use the robot cable within a temperature range of 0 to 70°C to avoid the wire breakage when moving.

## Materials and Finishes

Item	Model	XS5F/W-X	XS5F/W-XR
		Oil-resistant PVC cable	Oil-resistant PVC robot cable
Contacts		Copper alloy/Gold plating	
Fixtures		Zinc alloy/Nickel plating	
Fixtures (Lock) *		Stainless	
Pin block		PBT resin	
O-ring		Material combining HNBR and fluororubber	
Cover		PBT resin	
Cable		UL 758 (AWM) 6 mm dia. AWG20	UL 758 (AWM) 6 mm dia. AWG21

\* Only plug

## Connector Pinout Diagram (from Mating Side)

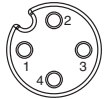
Item	No. of poles	4 poles
A-coding (For DC sensors)	Male (plug) contacts	
	Female (socket) contacts	

## Connection Combinations

Socket	OMRON model No.	Plug	
		Smartclick Plug Connectors	M12 Plug Connectors
Smartclick Socket Connectors	XS5F, XS5C XS5W (socket side), XS5R (socket side), XS5P *	XS5H, XS5G, XS5W (plug side), XS5R (plug side), XS5M *	XS2H, XS2G, XS2W (plug side), XS2R (plug side), XS2M *
M12 Socket Connectors	XS2F, XS2C, XS2W (socket side), XS2R (socket side), XS2P *		

\* XS2P/XS5P and XS5M, XS2M cannot mate with each other.

Note: ⊙: Connected by twisting.  
○: Connected by screwing.

## Dimensions

(Unit: mm)

Both end connector type  
XS5W-D421-□81-X  
XS5W-D421-□81-XR

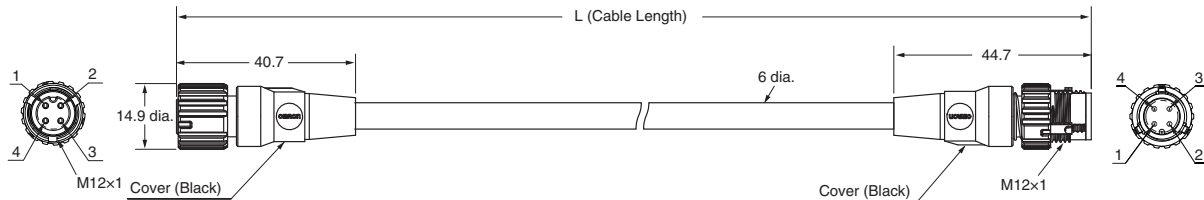

### Wiring Diagram for 4 Cores

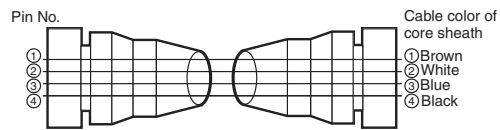

One end connector type  
XS5F-D421-□80-X  
XS5F-D421-□80-XR

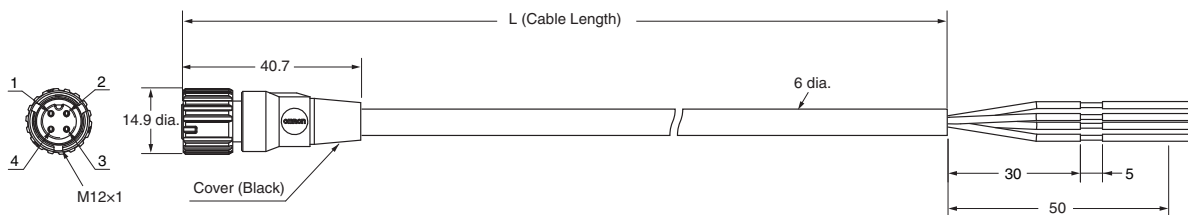

### Wiring Diagram for 4 Cores

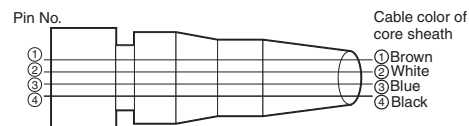

## Safety Precautions

### Meaning of Display

<b>Precautions for Safe Use</b>	Supplementary comments on what to do or avoid doing, to use the product safely.
<b>Precautions for Correct Use</b>	Supplementary comments on what to do or avoid doing, to prevent failure to operate, malfunction, or undesirable effects on product performance.

### Precautions for Safe Use

#### Degree of Protection

Do not use the product if its protective capabilities have been compromised, such as through swelling or cracks to housing or seal materials.

If products in this state continue to be used, then cutting oil or other contaminants may enter the product, leading to breakages or damage from fire.

#### Connector Connection and Disconnection

- When connecting or disconnecting Connectors, be sure to hold the Connectors by hand.
- Do not hold the cable when disconnecting Connectors. Check the alignment using the slot in the polarity key.
- Do not wiring the Connector when your hands are wet. Malfunctions or device damage may occur when power is supplied to a device.
- When mating Connectors, be sure to insert the plug all the way to the back of the socket before attempting to lock the Connectors. After you lock a Connector, always confirm that it is mated properly.
- Do not use tools of any sort to mate the Connectors. Always use your hands. Pliers or other tools may damage the Connectors.
- When you replace a Connector, make sure that there is no liquid, cutting oil, or other foreign matter on the mating surfaces before you mate the Connector.

#### Disposal

Dispose of this product as industrial waste.

### Precautions for Correct Use

- Do not use the Connectors in an atmosphere or environment that exceeds the specifications.
- Always turn OFF the power supply before wiring. Failure to turn OFF the power supply may lead to electric shock or damage to devices.
- As usage in environments in which cutting oil is used may impact service life and performance, ensure the following requirements are met.
  - Usage with cutting oil requirements as defined in specifications.
  - Usage at a dilution ratio as recommended by cutting oil manufacturers.
  - Usage immersed in oil or water is prohibited.

The cutting oil used may have a different impact on product service life. Ensure that the product is used only after confirming with the customer that there has been no deformation or deterioration of seal material from the cutting oil.

- The mating coupler will impact the oil-resistance performance values (years). Confirm mating of the couplers before use.

### Mating Combinations

	XS5□R	XS5□-X/XR	Other XS5/ XS2 Series
XS5□R	Oil-resistance performance values 4 years	Oil-resistance performance values 2 years	Water-resistance
XS5□-X/XR	Oil-resistance performance values 2 years	Oil-resistance performance values 2 years	Water-resistance
Other XS5/XS2 Series *	Water-resistance	Water-resistance	Water-resistance

\* Oil-resistant (polyurethane) cable products (XS5F-P, XS5H-P, XS5W-P) as well as oil-resistant (polyurethane) robot cables (XS5F-PR, XS5W-PR) are excluded. Please consult with OMRON for details of these products.

- Environments with corrosive gases and high temperature and humidity can cause bad connections and damage through corrosion, leading to degraded performance, therefore do not use these products in such environments.
- Do not pull on the Connectors or cables with excessive force.
- Do not step on or place any objects on the Connectors. Doing so may damage the Connectors.
- Lay the cable where it will not be stepped on to prevent the wires in the cable from being disconnected and to protect the Connectors from being damaged. If the cable must be placed where it will be stepped on, install a protective cover.
- At installation, if not installing sensors or switches, and not mating plug connectors, then use water-resistant covers (XS5Z-11, XS2Z-11) or dust-resistant covers (XS2Z-13/14/15) in order to ensure correct connector mating.

### Wiring

- Do not wire cables in environments in which the cable terminal sections will be subject to fluids such as water or cutting oil.
- When wiring cables, ensure this is carried out in accordance with the wiring diagram.
- Lay the cables so that external force is not applied to the Connectors. Otherwise, the degree of protection (IP67G) may not be achieved.

### Degree of Protection (IP67)

- The degree of protection of Connectors (IP67) is not for a fully watertight structure. Do not use the Connectors underwater.
- Do not step on or place any objects on the Connectors. Doing so may damage the Connectors.



**Setup**

- Do not install the Connectors with a load placed directly on the joint or at the point where the wires connect to the Connector. The Connector may be damaged or the wires in the cable may be disconnected.
- If bending cables, ensure that these use a minimum bend radius of 40 mm.

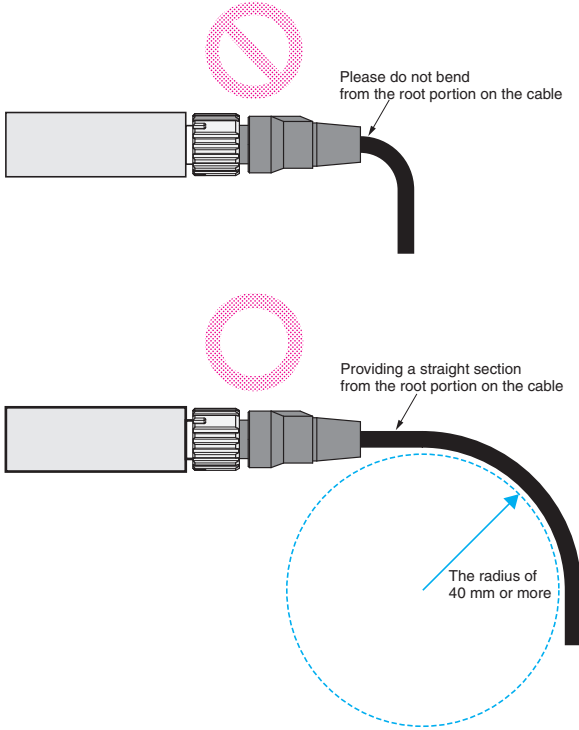

**Connecting**

**1. Connecting the XS5 Plug and Socket**

- Align the projection on the plug cover with the polarity key on the socket, then insert the plug all the way in.

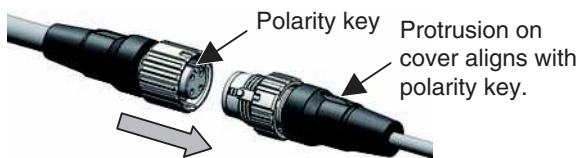

- Hold the knurled socket grip, then insert the projection on the plug into the groove of the socket.

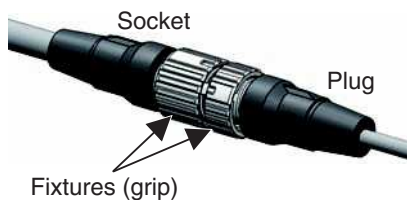

- Turn the knurled grips of the socket clockwise approximately 1/8 turn in respect to the plug. A click will indicate that the Connectors are locked. The locking condition can also be confirmed by the alignment marks on the plug and socket.



**2. Connecting the XS5 and XS2**

- Align the projection on the plug cover with the polarity key on the socket, then insert the plug all the way in.
- In the same way as when connecting two XS2 Connectors, screw the knurled grip in the clockwise direction.
- When mating the products to XS2 or other M12 Connectors, tighten the lock to a torque of 0.39 to 0.49 N·m.