

## Automotive dual-line TVS in SOT323-3L for CAN bus

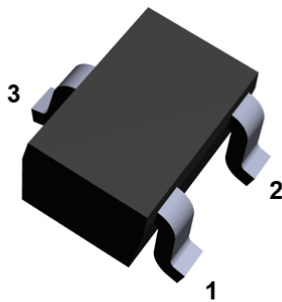

**SOT323-3L**  
(Jedec SC-70)

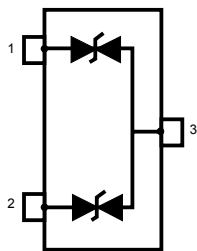

## Product status link

ESDCANxx-2BWY	<a href="#">ESDCAN02-2BWY</a> , <a href="#">ESDCAN03-2BWY</a> , <a href="#">ESDCAN04-2BWY</a> , <a href="#">ESDCAN05-2BWY</a> , <a href="#">ESDCAN06-2BWY</a>
---------------	---------------------------------------------------------------------------------------------------------------------------------------------------------------------------

## Features

- AEC-Q101 qualified 
- Dual-line ESD and EOS protection
- Breakdown voltage,  $V_{BR}$ :
  - ESDCAN02-2BWY: 28.5 V
  - ESDCAN03-2BWY: 26.5 V
  - ESDCAN04-2BWY: 27.5 V
  - ESDCAN05-2BWY: 39 V
  - ESDCAN06-2BWY: 38 V
- Bidirectional device
- Max pulse power up to 170 W (8/20  $\mu$ s)
- Low clamping factor  $V_{CL} / V_{BR}$
- Low leakage current
- ECOPACK<sup>®</sup>2 ROHS compliant component

## Complies with the following standards

- UL94, V0
- J-STD-020 MSL level 1
- IPC7531 footprint and JEDEC registered package
- ISO 16750-2 (Jump start and reversed battery tests)
- ISO 10605 - C = 150 pF, R = 330  $\Omega$ , exceeds level 4:
  - $\pm 30$  kV (air discharge)
  - $\pm 30$  kV (contact discharge)
- ISO 10605 - C = 330 pF, R = 330  $\Omega$  exceeds level 4:
  - $\pm 30$  kV (air discharge)
  - $\pm 30$  kV (contact discharge)
- ISO 7637-3:
  - Pulse 3a: -150 V
  - Pulse 3b: +150 V
  - Pulse 2a: +/- 85 V

## Applications

Automotive controller area network (CAN) bus lines where electrostatic discharges and other transients must be suppressed. These product are compliant with most of automotive interfaces.

## Description

These devices are dual-line transient voltage suppressor (TVS) specifically designed for the protection of automotive CAN bus lines against electrostatic discharge (ESD).

Their improved parameters make them compliant with all key drivers in automotive: CAN-FD, LIN, FlexRay, MOST, SENT, USB, etc.

# 1 Characteristics

**Table 1. Absolute ratings ( $T_{amb} = 25\text{ }^{\circ}\text{C}$ )**

Symbol	Parameter		Value	Unit	
$V_{PP}$	Peak pulse voltage	ISO 10605 - C = 150 pF, R = 330 $\Omega$ : Contact discharge	30	kV	
		Air discharge	30		
		ISO 10605 - C = 330 pF, R = 330 $\Omega$ : Contact discharge	ESDCAN02-2BWY ESDCAN03-2BWY		30
		Air discharge	ESDCAN04-2BWY		30
		ISO 10605 - C = 330 pF, R = 330 $\Omega$ : Contact discharge	ESDCAN05-2BWY ESDCAN06-2BWY		22
		Air discharge			22
$I_{PP}$	Peak pulse current (8/20 $\mu\text{s}$ )	ESDCAN02-2BWY ESDCAN03-2BWY ESDCAN04-2BWY	3.7	A	
		ESDCAN05-2BWY ESDCAN06-2BWY	3		
$T_j$	Operating junction temperature range		-55 to +175	$^{\circ}\text{C}$	
$T_{stg}$	Storage temperature range		-55 to +175	$^{\circ}\text{C}$	

**Figure 1. Electrical characteristics (definitions)**

Symbol	Parameter
$V_{BR}$ =	Breakdown voltage
$V_{RM}$ =	Stand-off voltage
$V_{CL}$ =	Clamping voltage
$I_{RM}$ =	Leakage current at $V_{RM}$
$I_{PP}$ =	Peak pulse current
$R_d$ =	Dynamic impedance
$C_{LINE}$ =	Input capacitance per line

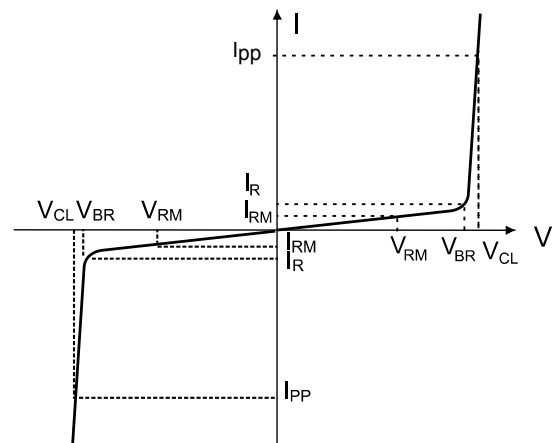

**Table 2. Electrical characteristics (values,  $T_{amb} = 25\text{ }^{\circ}\text{C}$ )**

Order code	$I_{RM}$ max. at $V_{RM}$		$V_{BR}$ at $I_R$			$V_{CL}$ Pulse ISO7637-3		$V_{CL}$ at $I_{PP}$ (8/20 $\mu$ s)		C		$\Delta C^{(1)}$	$\alpha T^{(2)}$
	$\mu$ A	V	Min.	Max.	mA	3a at -150 V min.	3b at +150 V max.	Max.	A	Typ.	Max.	Typ.	Typ.
			V			V		V		pF		pF	$10^{-4}/^{\circ}\text{C}$
ESDCAN02-2BWY	0.01	26.5	28.5	31.7	1	-36	36	44	3	3	3.5	0.01	9
ESDCAN03-2BWY	0.01	24	26.5	29.7	1	-34	34	41	3	3	3.5	0.01	9
ESDCAN04-2BWY	0.05	25.5	27.5	30.7	1	-35	35	43	3	17	19	0.1	9
ESDCAN05-2BWY	0.1	36	39	43.3	1	-45	45	61	3	3	3.5	0.01	9
ESDCAN06-2BWY	0.1	35	38	42.2	1	-44	44	59	3	13	15	0.1	9

1.  $\Delta C$  : capacitance variation between IO1 and IO2 versus GND

2. to calculate  $V_{BR}$  versus  $T_j$ :  $V_{BR}$  at  $T_j = V_{BR}$  at  $25\text{ }^{\circ}\text{C} \times (1 + \alpha T \times (T_j - 25))$

## 1.1 Characteristics (curves)

Figure 2. Maximum peak current versus initial junction temperature

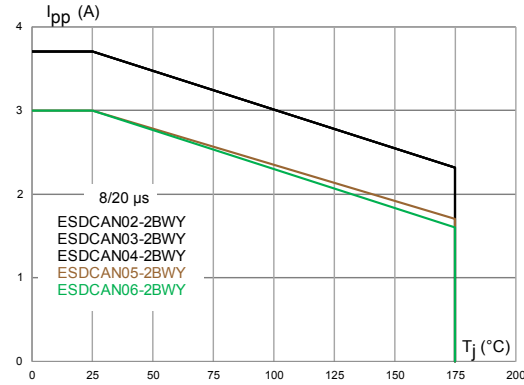

Figure 3. Maximum peak pulse current versus exponential pulse duration

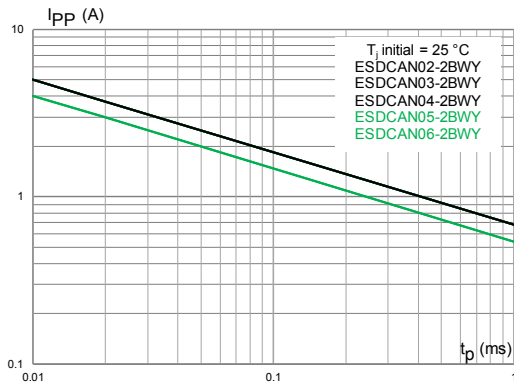

Figure 4. Peak pulse current versus clamping voltage

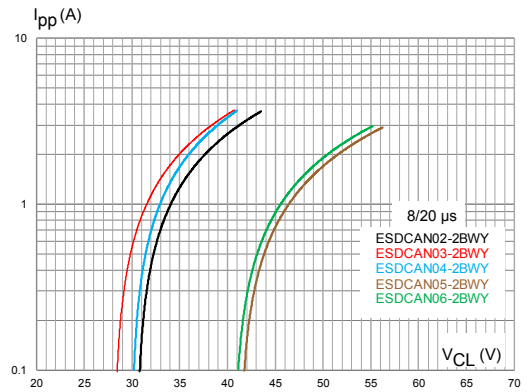

Figure 5. Junction capacitance versus reverse applied voltage

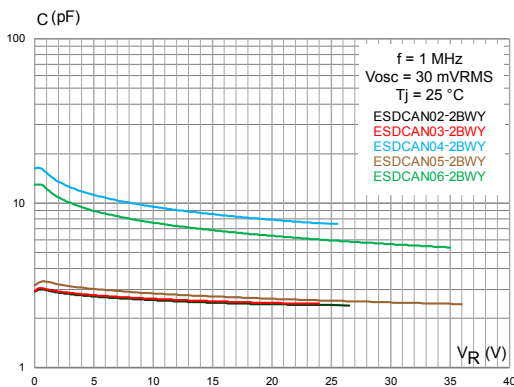
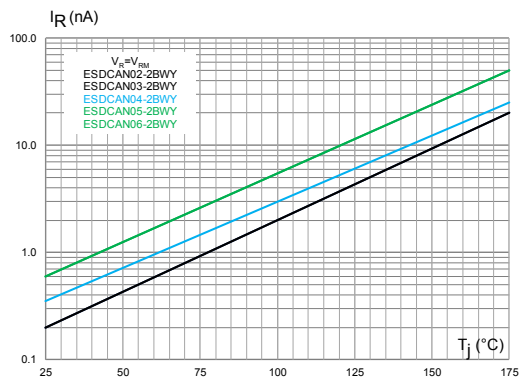
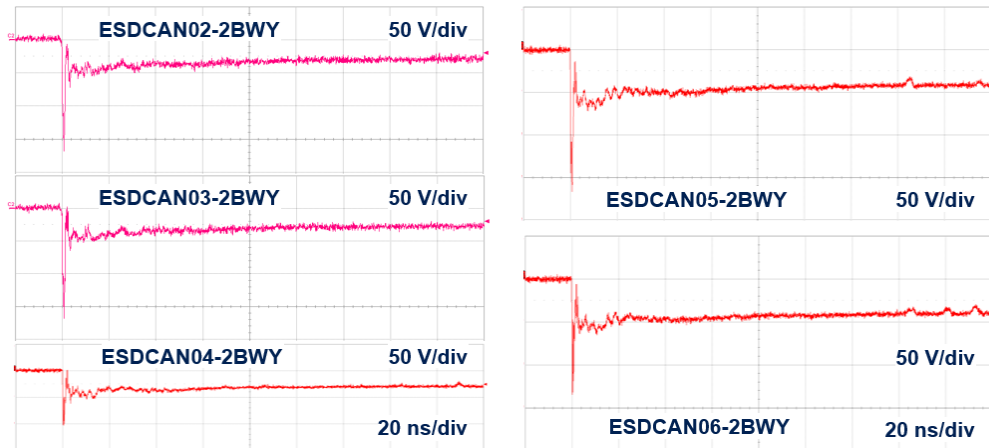
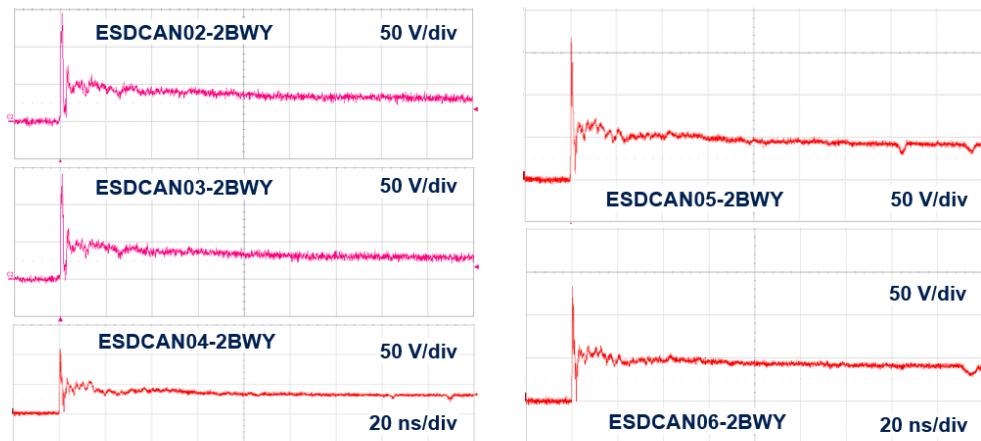
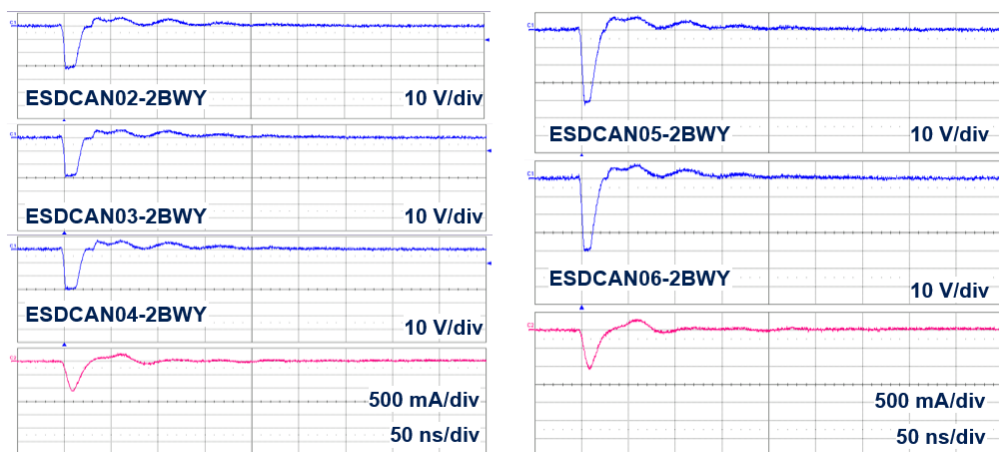

Figure 6. Leakage current versus junction temperature



**Figure 7. Response to ISO 10605 -C = 150 pF, R = 330 Ω (-8 kV contact)**

**Figure 8. Response to ISO 10605 - C = 150 pF, R = 330 Ω (+8 kV contact )**

**Figure 9. Response to ISO 7637-3 Pulse 3a: -150 V**

**Figure 10. Response to ISO 7637-3 Pulse 3b : +150 V**

**Figure 11. Response to ISO 7637-3 pulse 2a: -85 V**

**Figure 12. Response to ISO 7637-3 pulse 2a: +85 V**

Figure 13. S21 attenuation

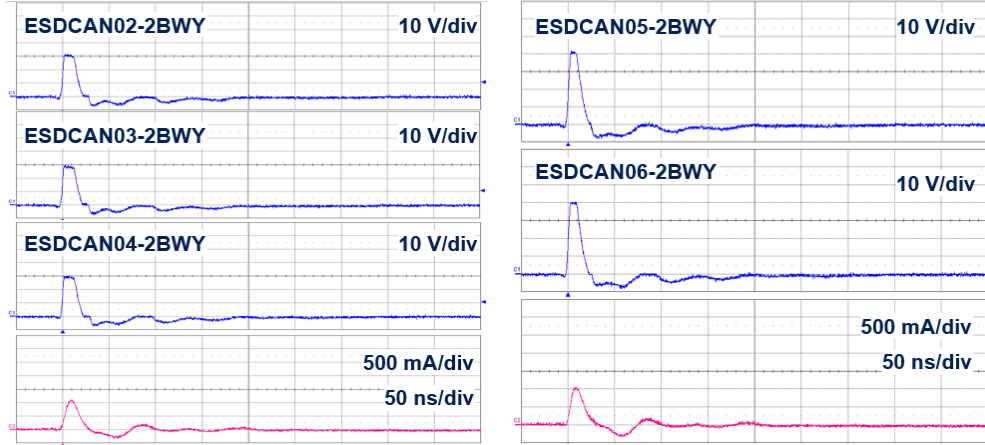
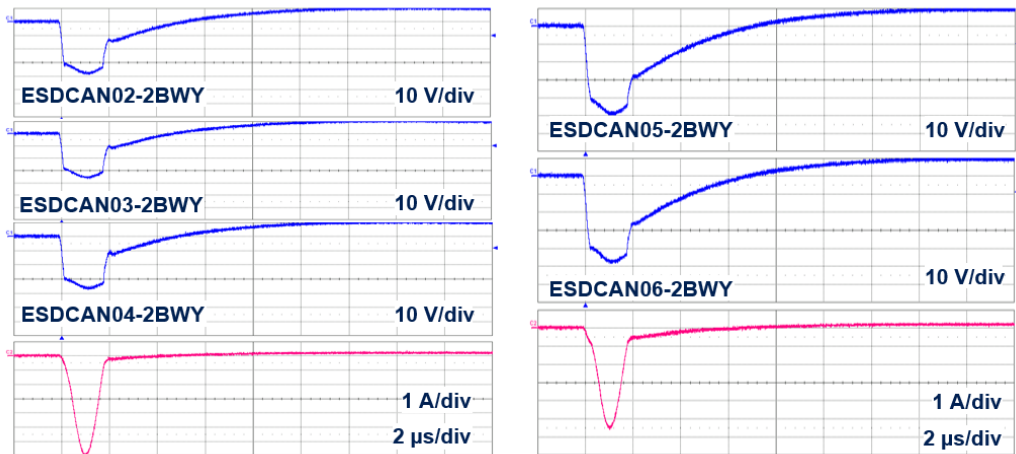
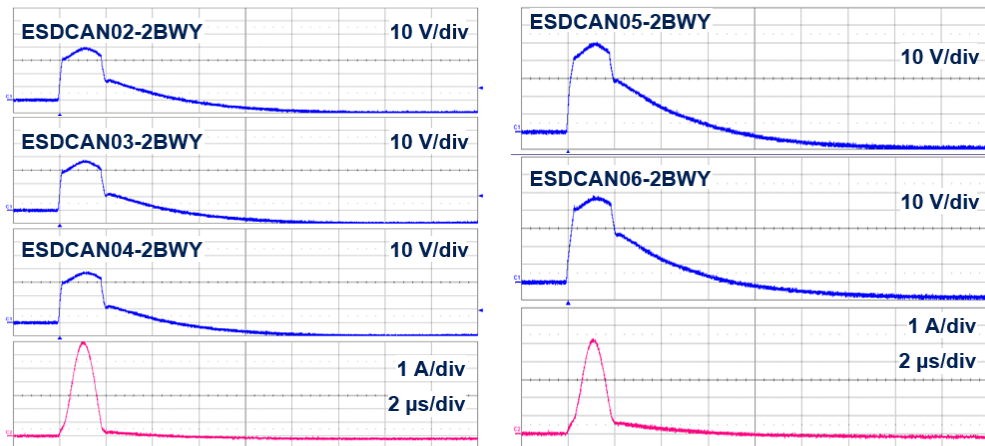
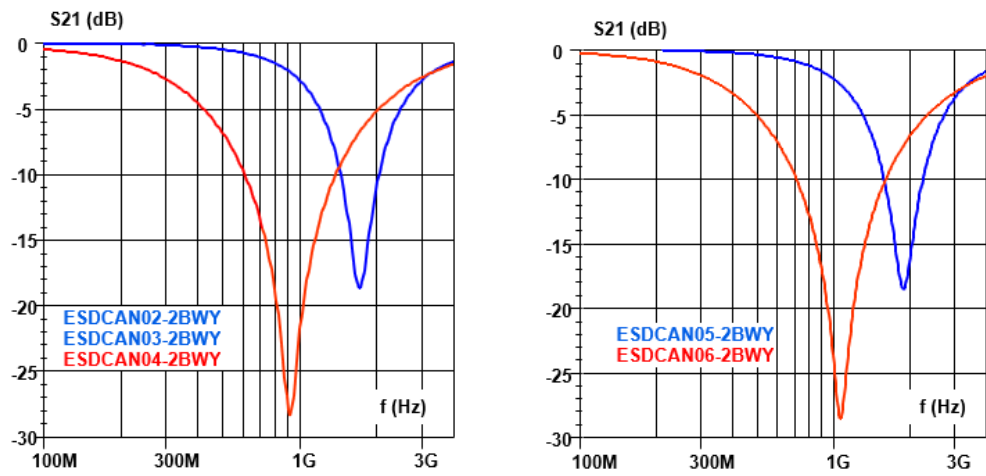
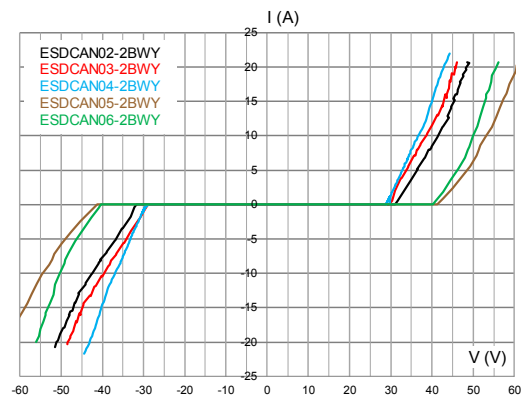

Figure 14. TLP



## 2 Package information

In order to meet environmental requirements, ST offers these devices in different grades of **ECOPACK®** packages, depending on their level of environmental compliance. ECOPACK® specifications, grade definitions and product status are available at: [www.st.com](http://www.st.com). ECOPACK® is an ST trademark.

### 2.1 SOT323-3L package information

**Figure 15. SOT323-3L package outline**

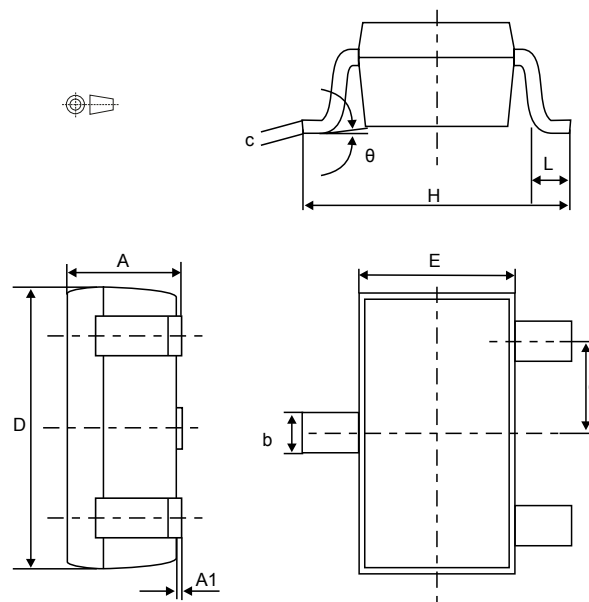

**Table 3. SOT323-3L package mechanical data**

Ref.	Dimensions					
	Millimeters			Inches <sup>(1)</sup>		
	Min.	Typ.	Max.	Min.	Typ.	Max.
A	0.80		1.10	0.031		0.044
A1	0.00		0.10	0.000		0.004
b	0.25		0.40	0.009		0.016
c	0.10		0.26	0.003		0.011
D	1.80	2.00	2.20	0.070	0.079	0.087
E	1.15	1.25	1.35	0.045	0.049	0.054
e	0.60	0.65	0.70	0.023	0.026	0.028
H	1.80	2.10	2.40	0.070	0.083	0.095
L	0.10	0.20	0.30	0.004	0.008	0.012
θ		0	30°		0	30°

1. Values in inches are converted from mm and rounded to 3 decimal digits

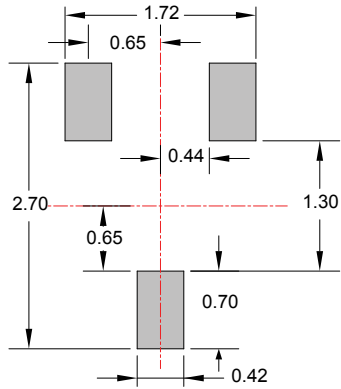
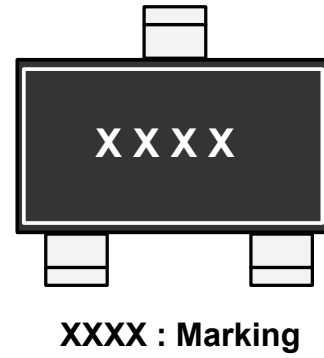
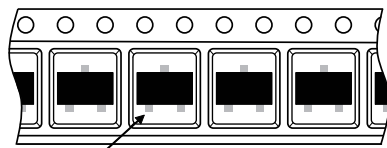

## 2.2 Packing information

**Figure 16. SOT323-3L footprint in mm (inches)**

**Figure 17. SOT323-3L marking**

**Figure 18. Package orientation in reel**

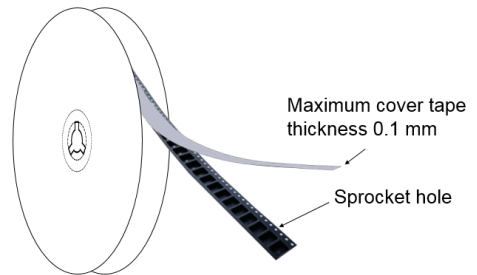
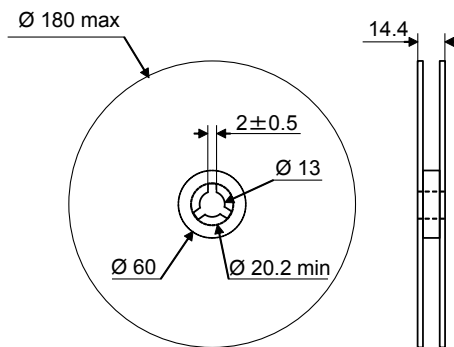
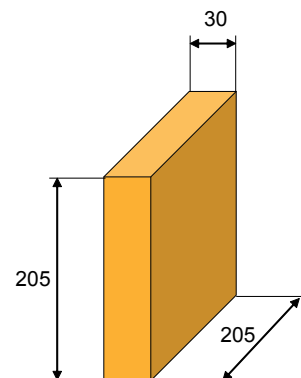
Pin 1 located according to EIA-481

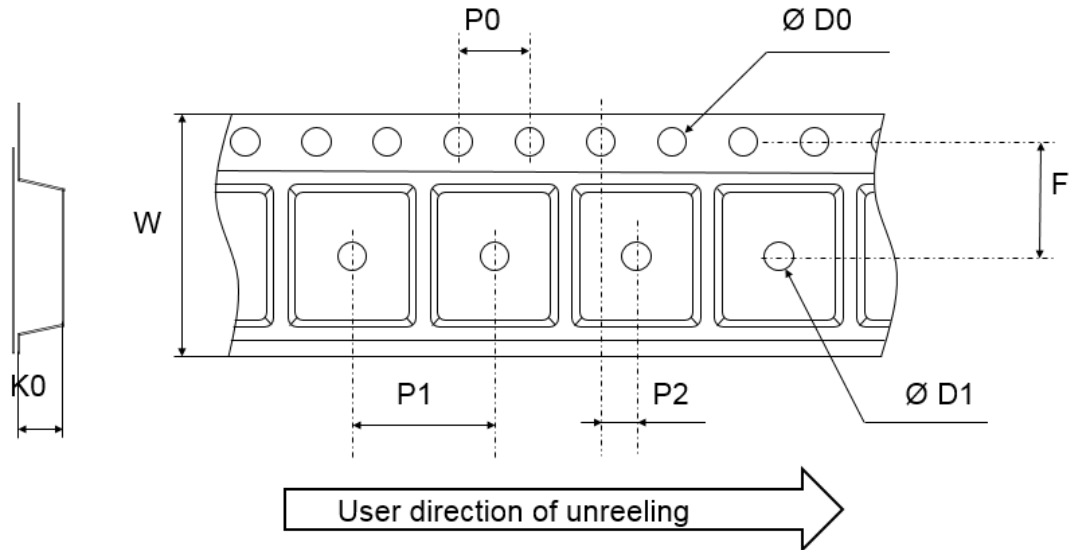
Note: Pocket dimensions are not on scale  
Pocket shape may vary depending on package

**Figure 19. Tape and reel orientation**

**Figure 20. 7" reel dimension values**

**Figure 21. Inner box dimension values**

**Figure 22. Tape outline**

Note: Pocket dimensions are not on scale  
 Pocket shape may vary depending on package

**Table 4. Tape dimension values**

Ref.	Dimensions		
	Millimeters		
	Min.	Typ.	Max.
D0	1.50	1.55	1.6
D1	1.00		
F	3.45	3.50	3.55
K0	1.12	1.22	1.32
P0	3.90	4.00	4.10
P1	3.90	4.00	4.10
P2	1.95	2.00	2.05
W	7.90	8.00	8.30

### 3 Reflow profile

**Figure 23. ST ECOPACK® recommended soldering reflow profile for PCB mounting**

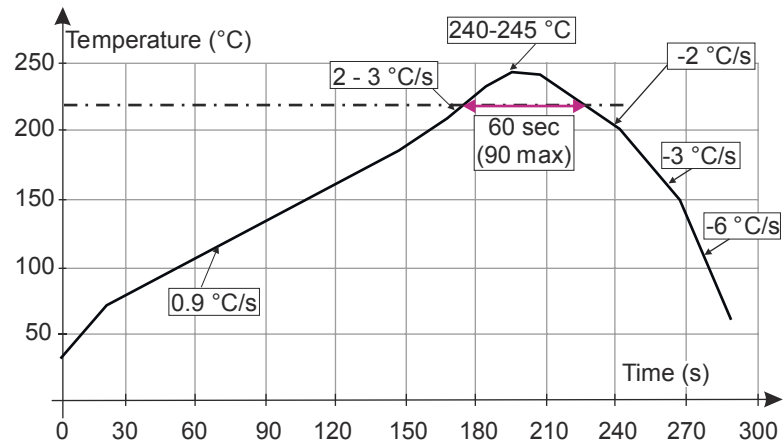

**Note:** Minimize air convection currents in the reflow oven to avoid component movement. Maximum soldering profile corresponds to the latest IPC/JEDEC J-STD-020.

## 4 Ordering information

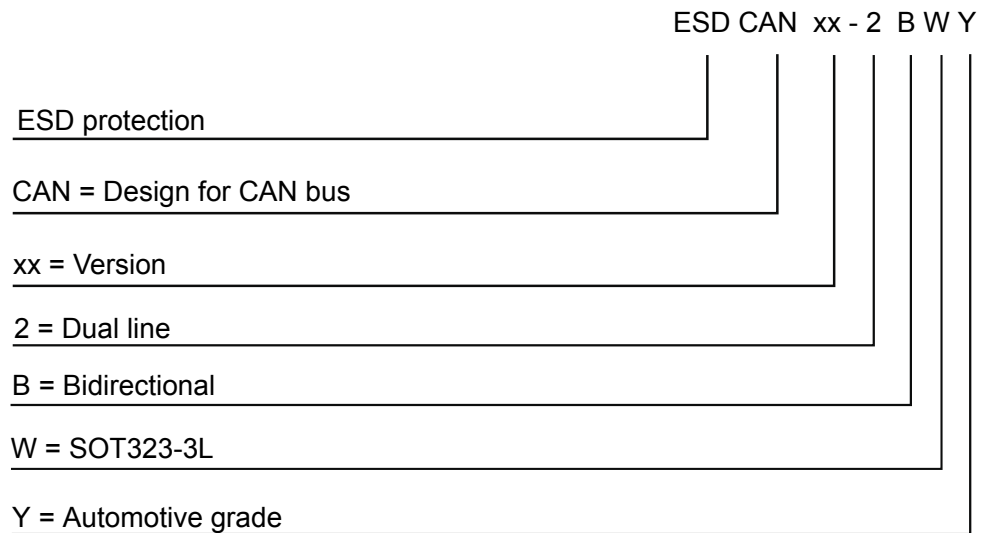
**Figure 24. Ordering information scheme**

**Table 5. Ordering information**

Order code	Marking <sup>(1)</sup>	Package	Weight	Base qty.	Delivery mode
ESDCAN02-2BWY	C02	SOT323-3L	6.58 mg	3000	Tape and reel
ESDCAN03-2BWY	C03				
ESDCAN04-2BWY	C04				
ESDCAN05-2BWY	C05				
ESDCAN06-2BWY	C06				

1. The marking can be rotated by multiples of 90° to differentiate assembly location

## Revision history

**Table 6. Document revision history**

Date	Revision	Changes
17-Oct-2018	1	First issue.
13-Nov-2018	2	Updated product name on cover page.

**IMPORTANT NOTICE – PLEASE READ CAREFULLY**

STMicroelectronics NV and its subsidiaries (“ST”) reserve the right to make changes, corrections, enhancements, modifications, and improvements to ST products and/or to this document at any time without notice. Purchasers should obtain the latest relevant information on ST products before placing orders. ST products are sold pursuant to ST’s terms and conditions of sale in place at the time of order acknowledgement.

Purchasers are solely responsible for the choice, selection, and use of ST products and ST assumes no liability for application assistance or the design of Purchasers’ products.

No license, express or implied, to any intellectual property right is granted by ST herein.

Resale of ST products with provisions different from the information set forth herein shall void any warranty granted by ST for such product.

ST and the ST logo are trademarks of ST. All other product or service names are the property of their respective owners.

Information in this document supersedes and replaces information previously supplied in any prior versions of this document.

© 2018 STMicroelectronics – All rights reserved