

Bild / Picture

Anwendung / Application

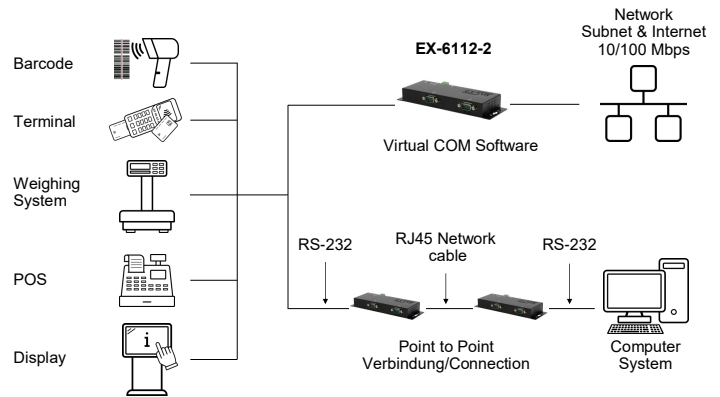

2x Seriell RS-232/422/485 zu Ethernet
Metallgehäuse



2x Serial RS-232/422/485 to Ethernet
Metal housing

Beschreibung

Description

Der EX-6122-2 ist ein serieller Multiprotokoll-RS-232/422/485-Geräteserver, der für den Anschluss von seriellen RS-232/422/485-Geräten, einschließlich Kassensystemen, Barcode-Lesegeräten, Sensoren, Messgeräten, Wiegesystemen, CNC-Steuerungen und SPS, an ein IP-basiertes Ethernet-Netzwerk entwickelt wurde. Die seriellen Geräte werden über Ethernet verbunden und stehen im Subnetz und Internet zur gemeinsamen Nutzung zur Verfügung. Die Fernkonfiguration erfolgt über umfangreiche Netzwerkprotokolle wie TCP-Server, TCP-Client, UDP, VCOM, serielles Telnet, RFC2217, Remote-Pair-Master-Slave oder Modbus RTU. Um die Abwärtskompatibilität zu seriellen Legacy-Geräten zu gewährleisten, auf denen die vorhandene COM-Port-Anwendungssoftware läuft, bietet der EX-6122-2 einen virtuellen COM-Port (VCOM), der Ihre serielle Anwendung perfekt migriert, ohne die Software zu modifizieren. Darüber hinaus können serielle Geräte im Peer-to-Peer-Modus miteinander kommunizieren, ohne dass ein PC zwischengeschaltet werden muss oder eine Konvertierungssoftware erforderlich ist.

The EX-6122-2 is a multi-protocol RS-232/422/485 serial device server designed to connect RS-232/422/485 serial devices, including point-of-sale systems, barcode readers, sensors, meters, weighing systems, CNC controllers and PLCs, to an IP-based Ethernet network. The serial devices are connected via Ethernet and are available for sharing on the subnet and Internet. Remote configuration is done via extensive network protocols such as TCP server, TCP client, UDP, VCOM, serial Telnet, RFC2217, remote pair master slave or Modbus RTU. To ensure backward compatibility with legacy serial devices running existing COM port application software, the EX-6122-2 provides a virtual COM port (VCOM) that perfectly migrates your serial application without modifying the software. In addition, serial devices can communicate with each other in peer-to-peer mode without the need for an intermediate PC or conversion software.

Merkmale

Features

<ul style="list-style-type: none"> Schnittstelle RS-232 V.24, RS-422/485 einstellbar mit Dipp-Schalter 	<ul style="list-style-type: none"> Interface: RS-232 V.24, RS-422/485 selected by DIP switches
<ul style="list-style-type: none"> 15 KV ESD Überspannungsschutz für alle seriellen Signale 	<ul style="list-style-type: none"> 15KV ESD Surge Protection for all serial signals
<ul style="list-style-type: none"> Daten Bits: 5, 6, 7, 8 / Parity: None, Even, Odd, Mark, Space 	<ul style="list-style-type: none"> Data Bits: 5, 6, 7, 8 / Parity: None, Even, Odd, Mark, Space
<ul style="list-style-type: none"> Signale RS-232: TXD, RXD, RTS, CTS, DTR, DSR, DCD und GND RS-422: TXD+, TCD-, RXD+ RXD-, GND RS-485: 2 Draht - Data+, Data-, GND RS-485: 4 Draht - TXD+, TCD-, RXD+, RXD-, GND 	<ul style="list-style-type: none"> Signal: RS-232: TXD, RXD, RTS, CTS, DTR, DSR, DCD und GND RS-422: TXD+, TCD-, RXD+ RXD-, GND RS-485: 2 wire - Data+, Data-, GND RS-485: 4 wire - TXD+, TCD-, RXD+, RXD-, GND
<ul style="list-style-type: none"> Ethernet Protokolle: TCP Server, TCP Client, UPD, VCOM, Serial Telnet RFC2217, Remote-Pair-Master-Slave, Modbus Server Modbus Client 	<ul style="list-style-type: none"> Ethernet Protocol: TCP Server, TCP Client, UPD, VCOM, Serial Telnet RFC2217, Remote-Pair-Master-Slave, Modbus Server Modbus Client
<ul style="list-style-type: none"> Direktzugriff über Socket Port 	<ul style="list-style-type: none"> Direct connection with Socket Port
<ul style="list-style-type: none"> Punkt zu Punkt Verbindung, benötigt keine Software 	<ul style="list-style-type: none"> Point to point connection, no software required
<ul style="list-style-type: none"> Virtual-COM Software als Download 	<ul style="list-style-type: none"> Virtual COM Software for download
<ul style="list-style-type: none"> Robustes Metallgehäuse 	<ul style="list-style-type: none"> Rugged Metal Case
<ul style="list-style-type: none"> Für Desktop- oder Wandmontage, DIN-Rail Kit als Option 	<ul style="list-style-type: none"> Desktop or wall mounting, optional DIN-Rail Kit

System / OS

Geprüft / Approved

Verpackung / Packaging



Spezifikation

Specification

Datentransfer-Rate:	Seriell RS-232/422/485: bis 921.6KBaud Ethernet: 10/100Mbps	Data transfer rate:	Serial RS-232/422/485: up to 921.6KBaud Ethernet: 10/100Mbps
Anschlüsse:	2x RS-232 9 Pin Stecker 1x RJ45 Ethernet 1x DC-Jack +5 bis +24V (5.5 x 2.1mm)	Connectors:	2x RS-232 9 pin male 1x RJ45 Ethernet 1x DC-Jack +5 to +24V (5.5 x 2.1mm)
Hardwaresysteme:	Ethernet 10/100/1000Mbps	Hardware system:	Ethernet 10/100/1000Mbps
VCOM unterstützt Betriebssysteme:	Windows XP/Vista/7/8.x/10/11 (32/64Bit)	VCOM support the Operating System:	Windows XP/Vista/7/8.x/10/11 (32/64Bit)
Betriebssysteme:	Alle über IP und Port Nummer (Direktzugriff über Socket Port)	Operating systems:	All via IP and port number (direct access via socket port)
Betriebstemperatur :	0°C bis +60°C	Operating temperature :	32°F up to 140°F
Lagertemperatur:	-20°C bis +75°C	Storage temperature:	-4°F up to 167°F
Rel. Luftfeuchtigkeit:	5% bis 95%	Rel. Humidity:	5% to 95%
Schutzklasse:	IP 30	Protection class:	IP 30
Stromversorgung:	+5 bis +24 VDC	Current Supply:	+5 bis +24VDC
Strom verbrauch:	170mA@12V	Power consumption:	170mA@12V
Abmessung:	179.00 x 59.50 x 23.00 mm	Size:	179.00 x 59.50 x 23.00 mm
Gewicht:	290 g	Weight:	290 g
EAN:	4718359612213	EAN:	4718359612213
Ursprungsland:	Taiwan	Country of origin:	Taiwan
Lieferumfang:	EX-6122-2, Netzteil 12V/3A, Handbuch	Packaging contents:	EX-6122-2, Power Supply 12V/3A, Manual

Maße / Dimension

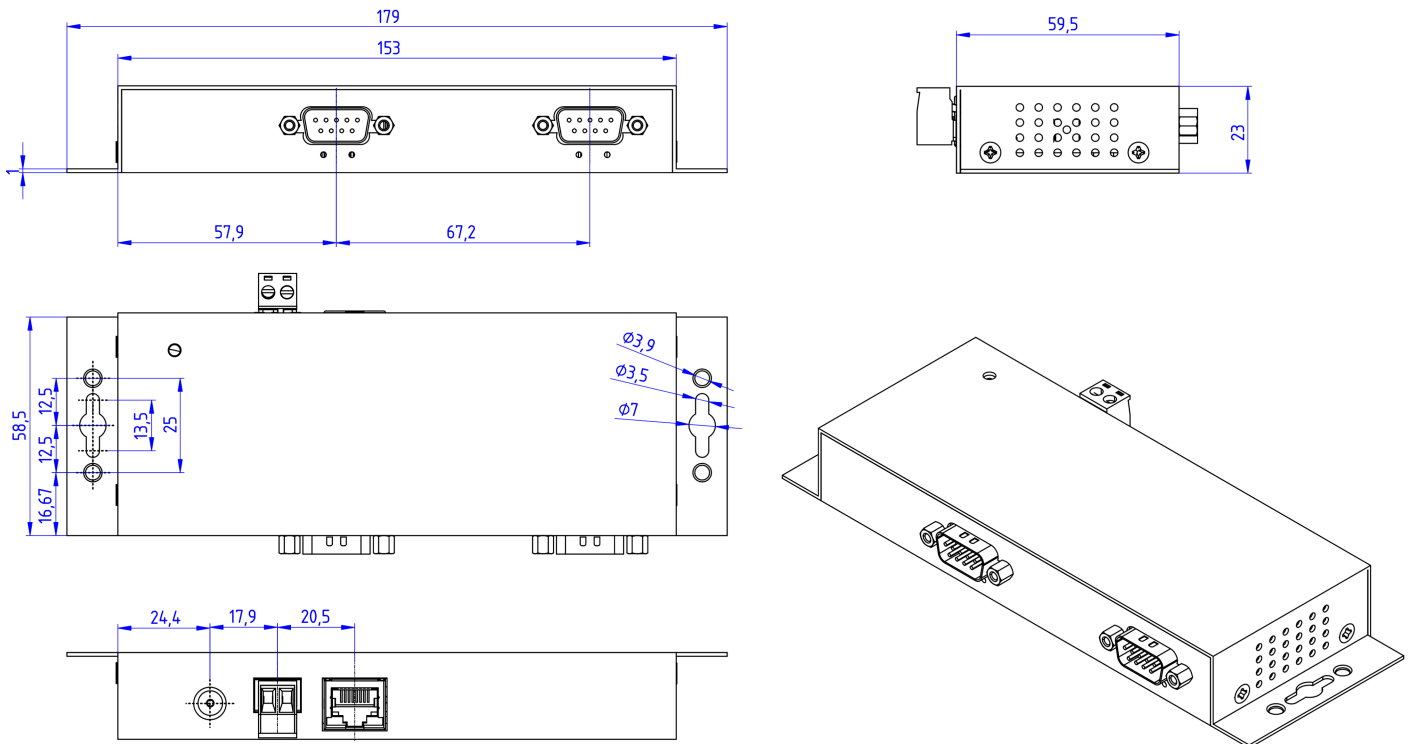

Bilder / Picture



Vergleichstabelle / Comparison Chart

Model No.	Serielle Schnittstelle/ Serial Interface	Anschlüsse/ Ports	Optical Isolation	Powered by PoE (PD)	Anschlussart/ Connector(s)	Input Power (DC)	Netzteil / Power Supply	Wall and DIN Rail Mounting Options
EX-6112-2	RS-232	2	-	-	Male DB9	5~24V	12V / 3A	✓
EX-6112-2PoE	RS-232	2	-	✓	Male DB9	5~24V	12V / 3A	✓
EX-6122-2	RS-232/RS-422/485	2	-	-	Male DB9	5~24V	12V / 3A	✓
EX-6122-2PoE	RS-232/RS-422/485	2	-	✓	Male DB9	5~24V	12V / 3A	✓
EX-6114-2	RS-232	4	-	-	Male DB9	5~24V	12V / 3A	✓
EX-6114-2PoE	RS-232	4	-	✓	Male DB9	5~24V	12V / 3A	✓
EX-6124-2	RS-232/RS-422/485	4	-	-	Male DB9	5~24V	12V / 3A	✓
EX-6124-2PoE	RS-232/RS-422/485	4	-	✓	Male DB9	5~24V	12V / 3A	✓

Zubehör / Accessories

EX-6973	Netzteil / Power Supply	HDR-60-24	Output: DC 24V/2.5A/60W	Input: 85V - 264VAC	Operating Temperatur: -30°C - +70°C
EX-6096	DIN-Rail Kit (Installation auf Trägerschiene / Installation to a DIN-Rail)				

EX-6973



EX-6096

