

CLIFF

RCA PHONO CONNECTORS

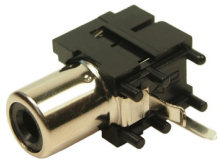

Part No: **FC68369**

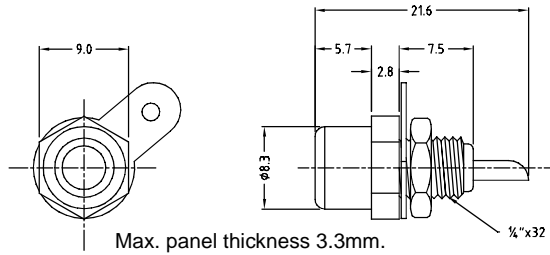

Part No: **FC68371**

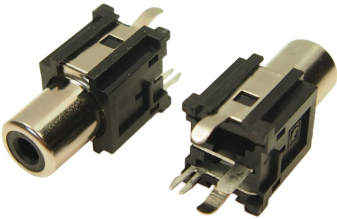
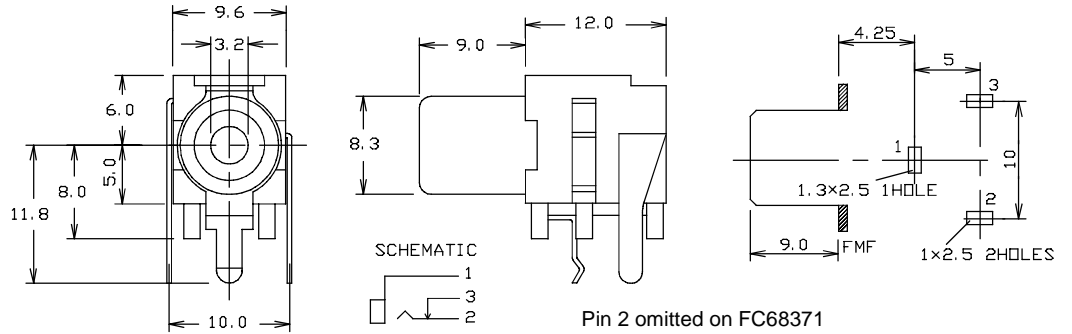

Part No: **FC68375**

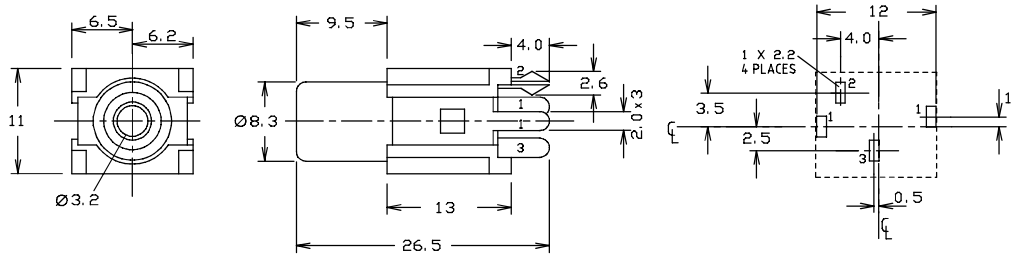

Part No: **FC68391**

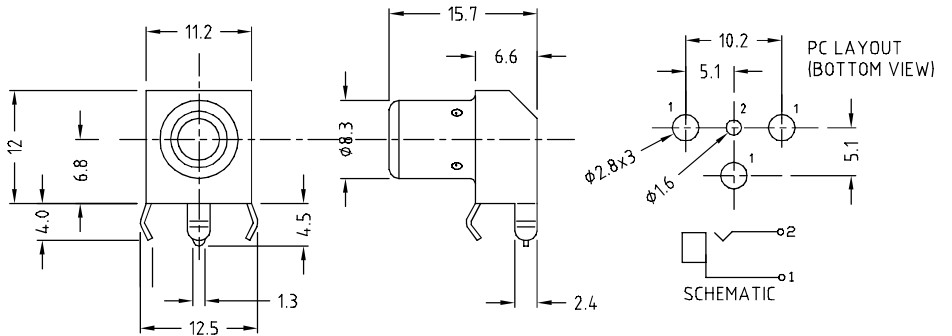

Part No: **FC68400**

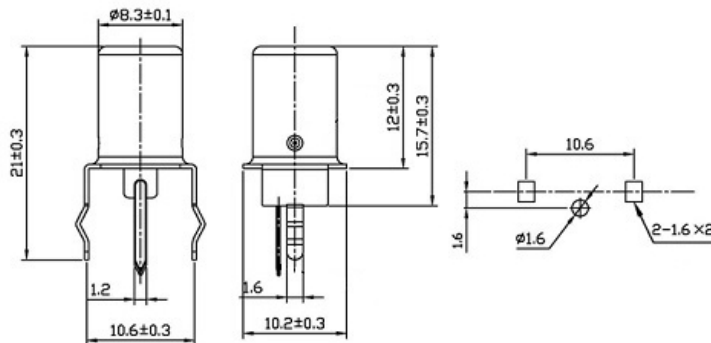

Part No: **FC68401**

CLIFF

RCA PHONO CONNECTORS



Part No: **FC68402G**



Part No: **FC68403**

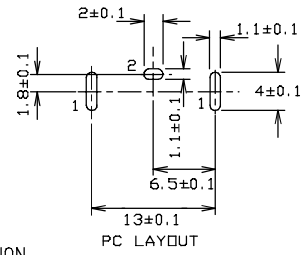
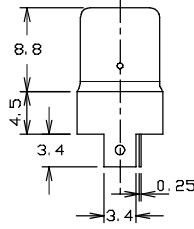
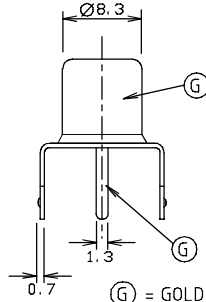
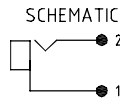
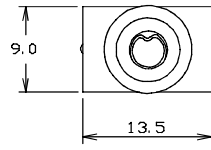

Ⓞ = GOLD PLATED PARTS IN 'G' VERSION



Part No: **FC68405**

Part No: **FC684052**

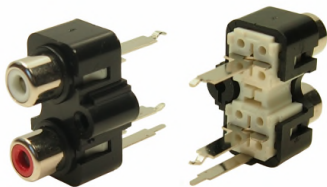
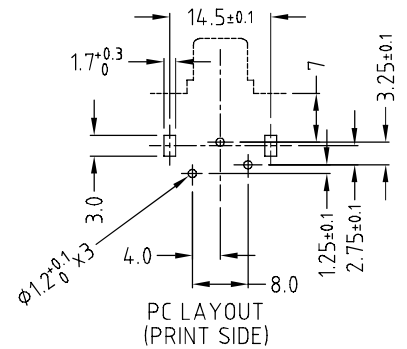
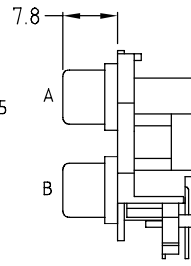
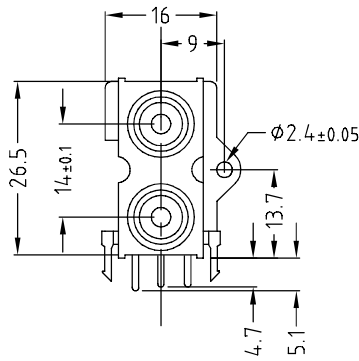

Part No: **FW6190**

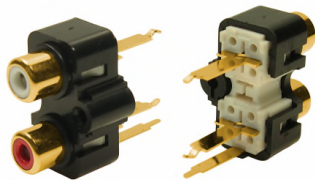

Part No: **FW6192**

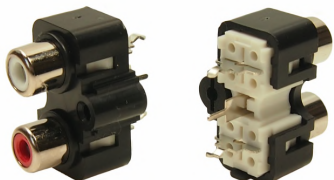
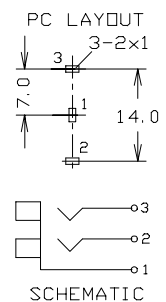
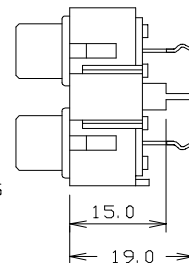
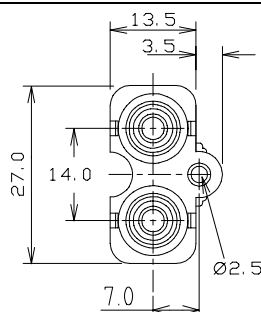
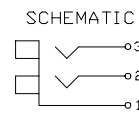
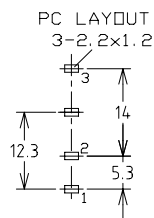
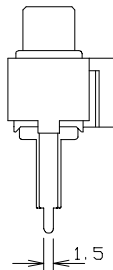
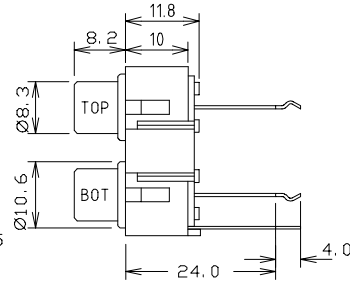
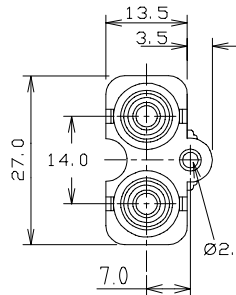

Part No: **FW6195**

CLIFF

RCA PHONO CONNECTORS

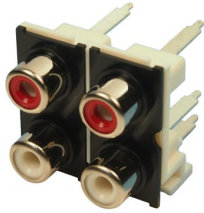

Part No: **FC684056**

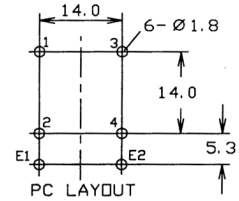
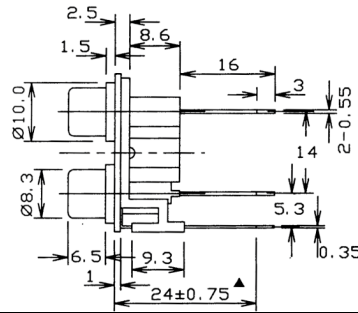
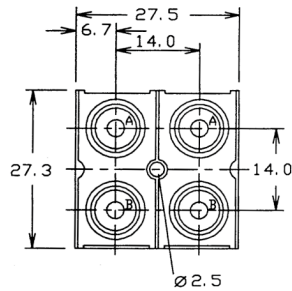

Electrical Specifications

Contact Resistance: 30mΩ max. @ AC 100mA max. 1kHz.

Dielectric Withstand: 500Vac @ 60 Hz for 1 minute.

Insulation Resistance: <100mΩ min. @ 500 Vdc.

Mechanical Specifications

Insertion Life (Minimum): >4000 insertions and removals.

Insertion Force: 0.03~3.0Kg.

Extraction Force: 0.03~3.0Kg.

For further information, contact sales@cliffuk.co.uk

Cliff Electronic Components Limited,

76 Holmethorpe Avenue, Holmethorpe Ind. Estate,
Redhill, Surrey RH1 2PF U.K.

Tel: +44 (0)1737 771375 Fax: +44 (0)1737 766012



Visit us online at:



www.cliffuk.co.uk