



TAOGLAS®



Datasheet

FXP810 2.4/4.9-6GHz Dual-band Antenna

Part No:
FXP810.07.0100C

Product Name

FXP810 Freedom Wi-Fi 2.4/4.9-6GHz Series
PIFA Antenna

Features:

- Very High Efficiency
- Ground-plane Independent
- IPEX MHF® I Connector (U.FL compatible)
- 1.37mm Diameter Micro Cable - 100 mm
- Dimensions: 31*31*0.1mm
- RoHS and Reach Compliant

1. Introduction	3
2. Specifications	4
3. Antenna Characteristics	10
4. Radiation Patterns	15
5. Mechanical Drawing	17
6. Footprint	18
7. Packaging	19
<hr/>	
Changelog	20

Taoglas makes no warranties based on the accuracy or completeness of the contents of this document and reserves the right to make changes to specifications and product descriptions at any time without notice. Taoglas reserves all rights to this document and the information contained herein. Reproduction, use or disclosure to third parties without express permission is strictly prohibited.



1. Introduction



The FXP810 has a peak gain of 1.5dBi at 2.4GHz and efficiencies of 60-70%, increasing to 5dBi and 80-90% along bands 4.9GHz to 6GHz.

At 31*31*0.1mm in size this antenna is uniquely valuable for small tag type mobile devices in that it can slip between the battery and the main PCB ground of small devices to get increased performance from the ground coupling effect. Only the top 6.5mm radiating element needs to protrude out from the side of the main board, allowing such devices to have the highest possible performance at smallest possible dimensions, it accomplishes this because it does not need clearance or footprint space on the device board itself that all on-board chip, loop and patch antennas need.

Many module manufacturers specify peak gain limits for any antennas that are to be connected to that module. Those peak gain limits are based on free-space conditions. In practice, the peak gain of an antenna tested in free-space can degrade by at least 1 or 2dBi when put inside a device. So ideally you should go for a slightly higher peak gain antenna than mentioned on the module specification to compensate for this effect, giving you better performance.

Upon testing of any of our antennas with your device and a selection of appropriate layout, integration technique, or cable, Taoglas can make sure any of our antennas' peak gain will be below the peak gain limits. Taoglas can then issue a specification and/or report for the selected antenna in your device that will clearly show it complying with the peak gain limits, so you can be assured you are meeting regulatory requirements for that module.

For example, a module manufacturer may state that the antenna must have less than 2dBi peak gain, but you don't need to select an embedded antenna that has a peak gain of less than 2dBi in free-space. This will give you a less optimized solution. It is better to go for a slightly higher free-space peak gain of 3dBi or more if available. Once that antenna gets integrated into your device, performance will degrade below this 2dBi peak gain due to the effects of GND plane, surrounding components, and device housing. If you want to be absolutely sure, contact Taoglas and we will test. Choosing a Taoglas antenna with a higher peak gain than what is specified by the module manufacturer and enlisting our help will ensure you are getting the best performance possible without exceeding the peak gain limits.

2. Specifications

Electrical		
Frequency (MHz)	2.4GHz	5.8GHz
	2400-2500	4900-5850
Efficiency (%)		
On 1.5mm ABS	64.9	70.4
Free space	52.8	65.1
Average Gain (dB)		
On 1.5mm ABS	-1.88	-1.52
Free space	-2.77	-1.86
Peak Gain (dBi)		
On 1.5mm ABS	2.52	6.37
Free space	1.77	6.14
Impedance	50 Ω	
Polarization	Linear	
Radiation Pattern	Omni	
Max. input power	2W	

Mechanical	
Dimensions	31mm*31mm*0.1mm
Material	Polymer
Connector	IPEX MHF® I U.FL Compatible
Cable	Gray 100mm 1.37 co-axial
Environmental	
Temperature Range	-40°C to 85°C

3. Antenna Characteristics

3.1 Return Loss

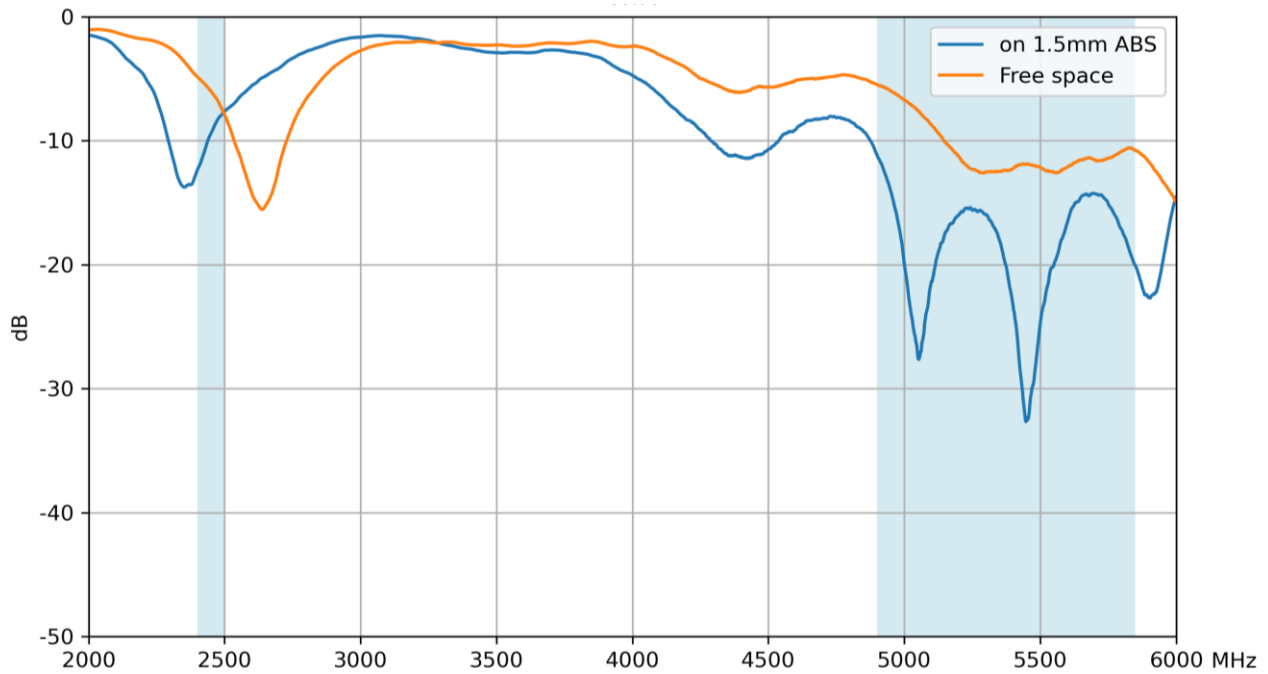

3.2 Efficiency

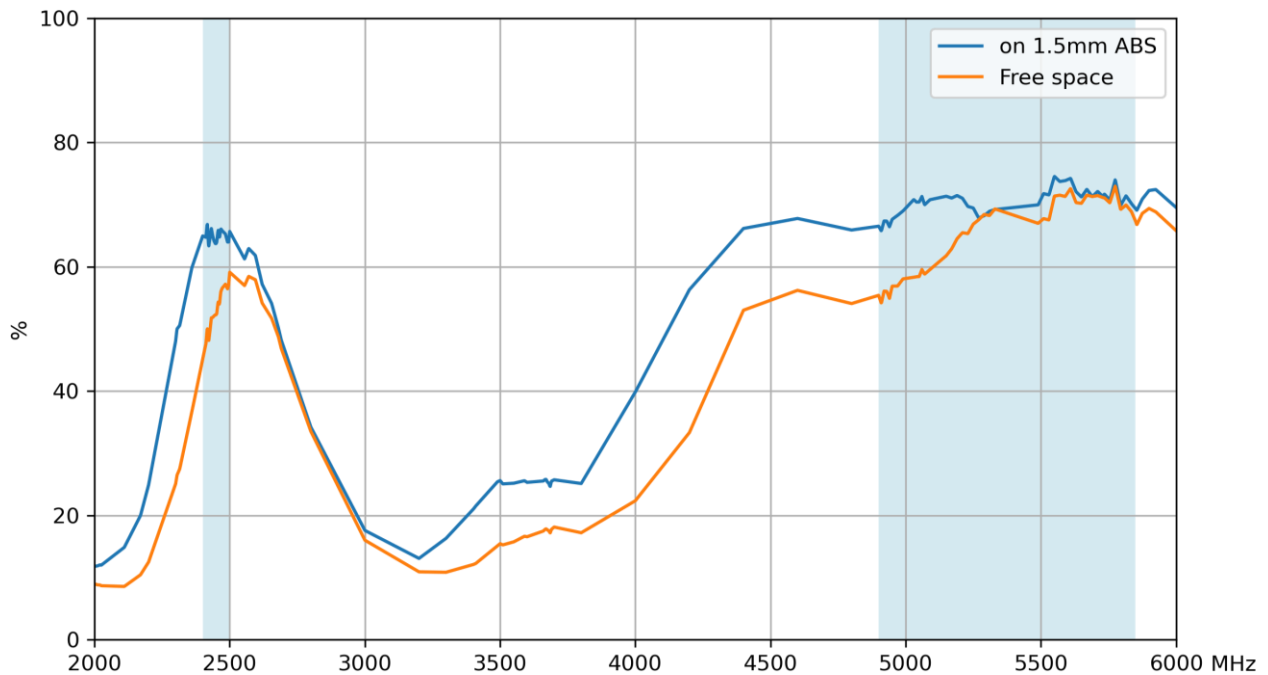

3.3 Average Gain

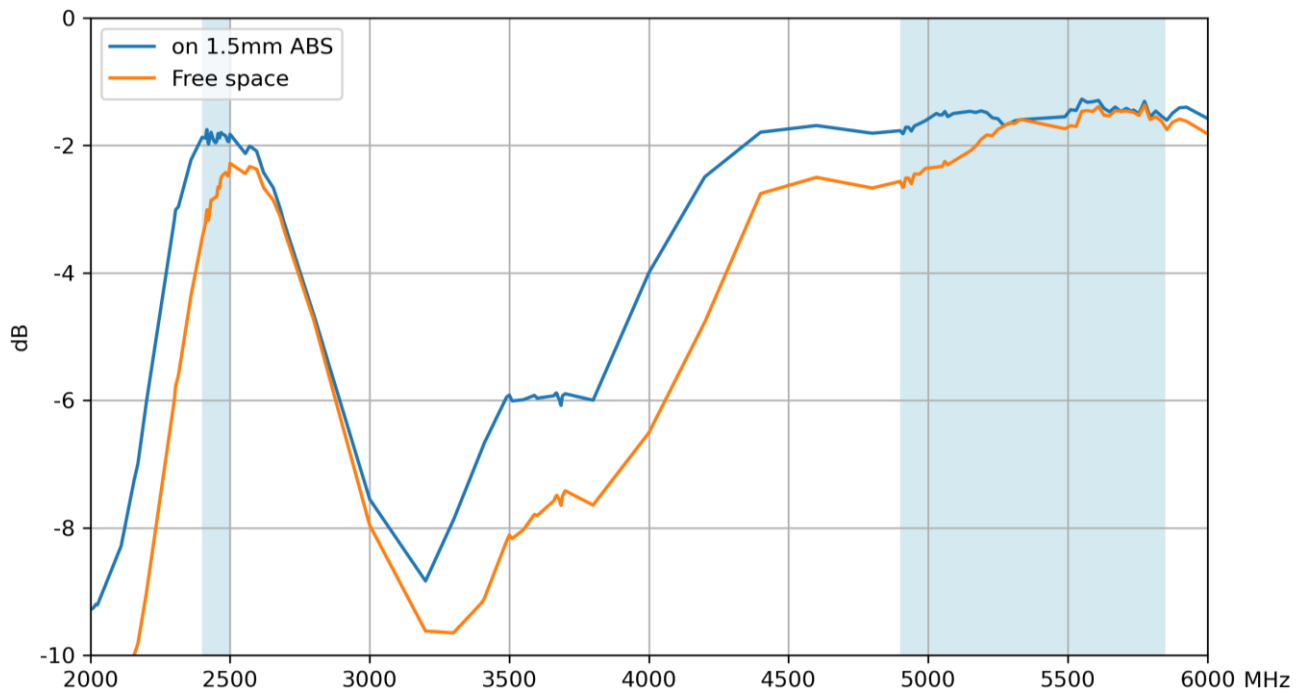

3.4 Peak Gain

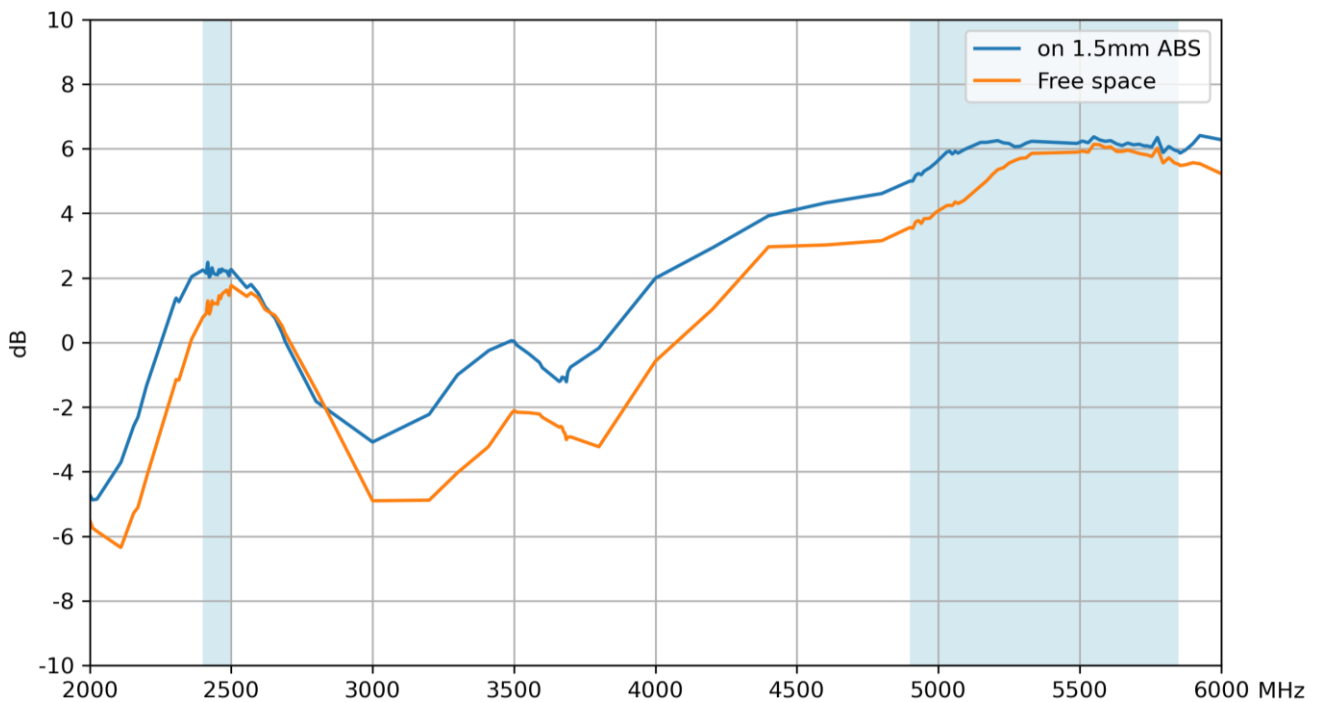

4. Radiation Patterns

4.1 Test Setup



Chamber Setup

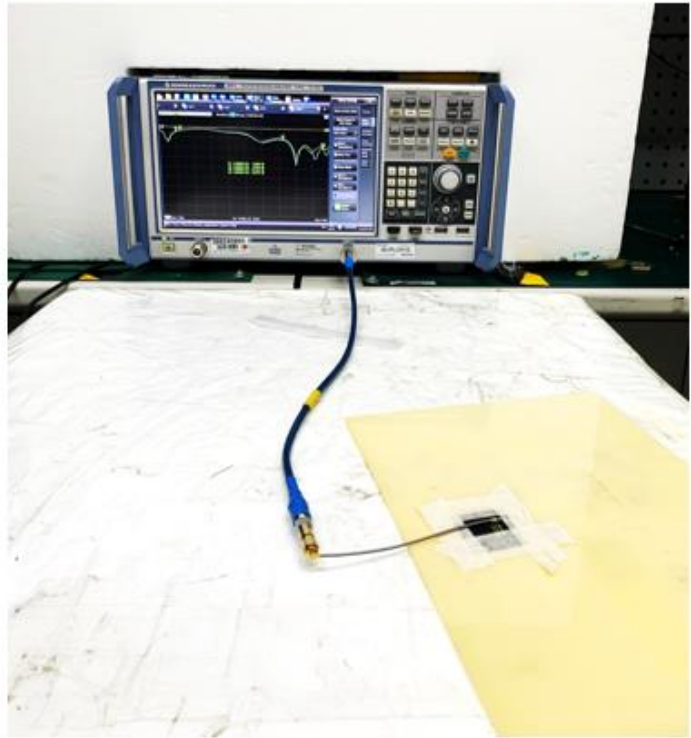

VNA Setup

4.2 Wi-Fi on 1.5mm ABS - 3D & 2D Radiation Patterns

Gain total, 2450MHz

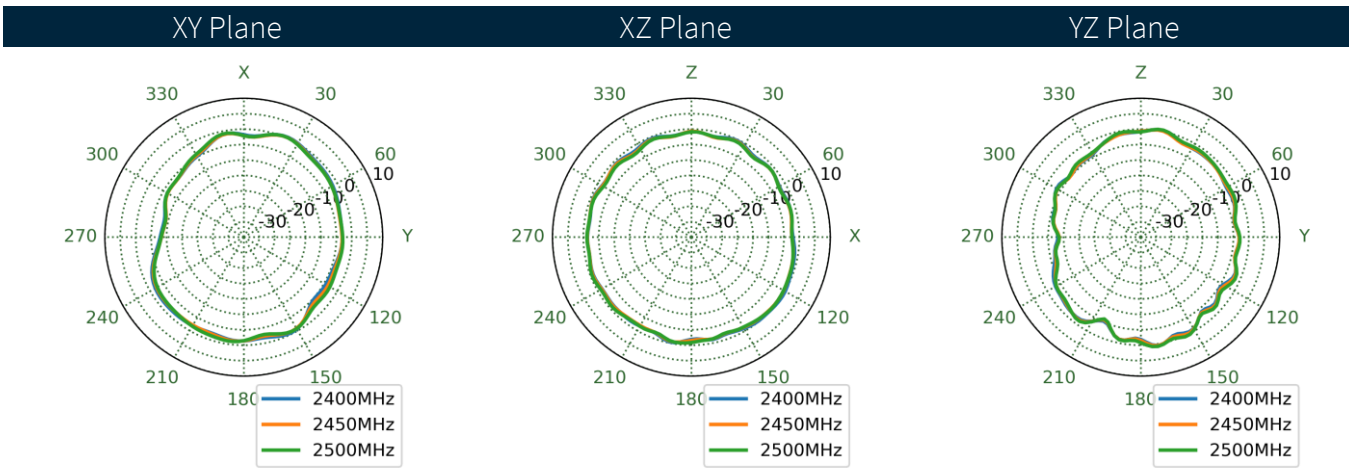
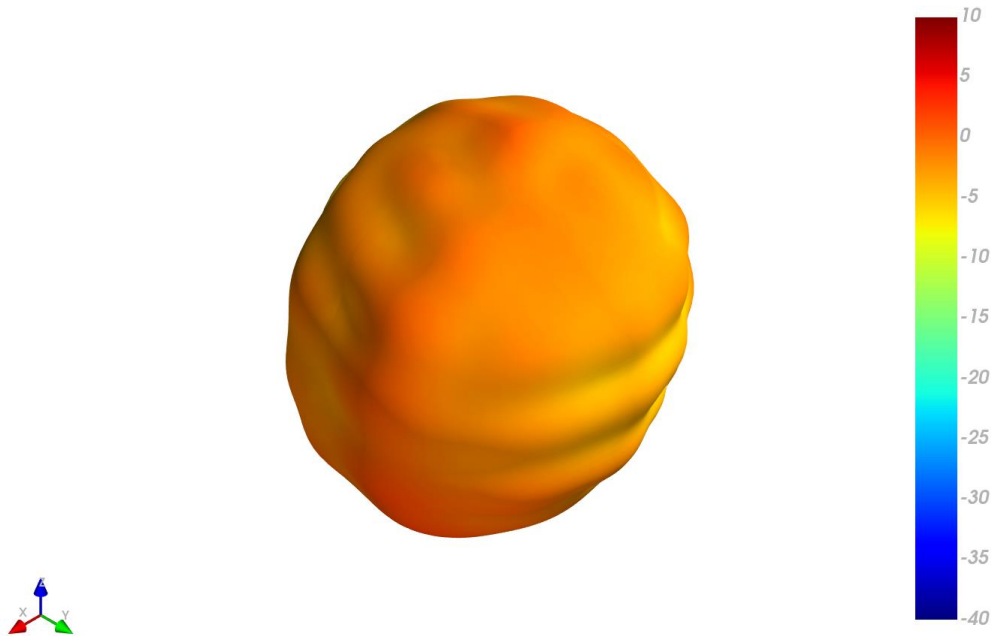

Gain total, 5550MHz

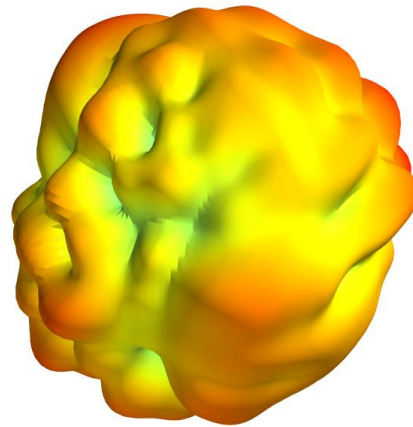

XY Plane XZ Plane YZ Plane

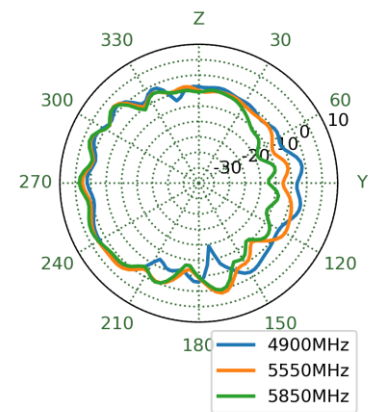
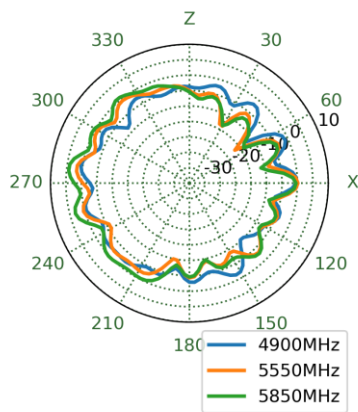
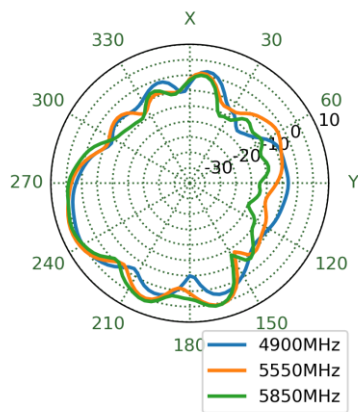

4.2 Wi-Fi in Free Space - 3D & 2D Radiation Patterns

Gain total, 2450MHz

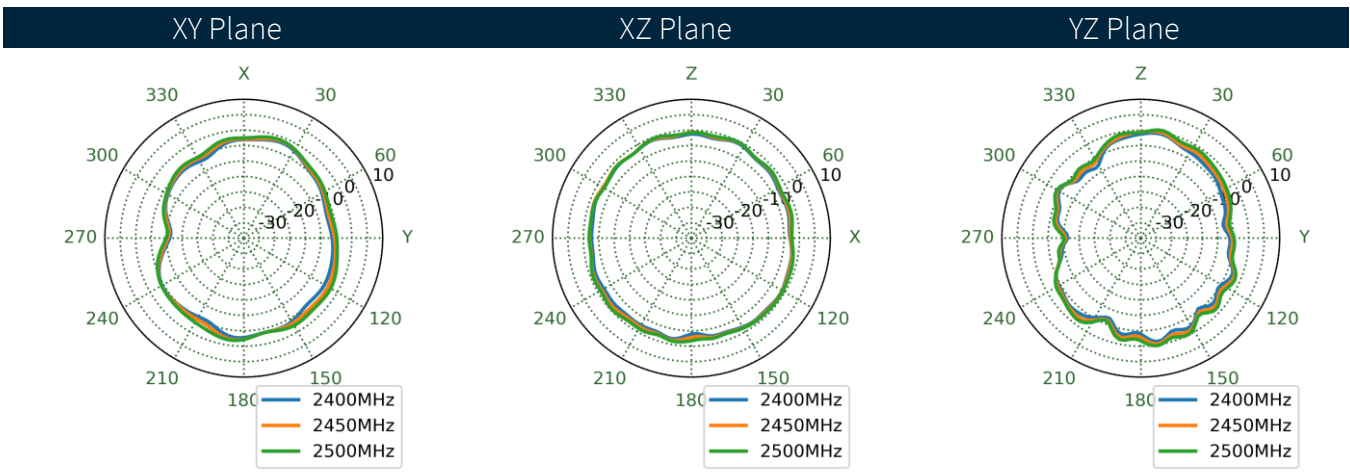
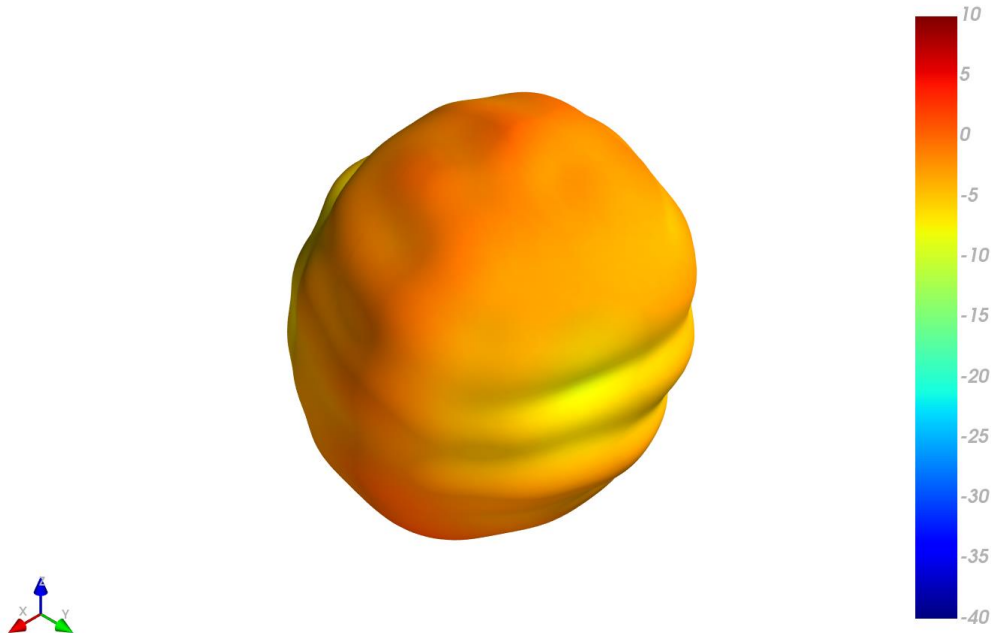

Gain total, 5550MHz

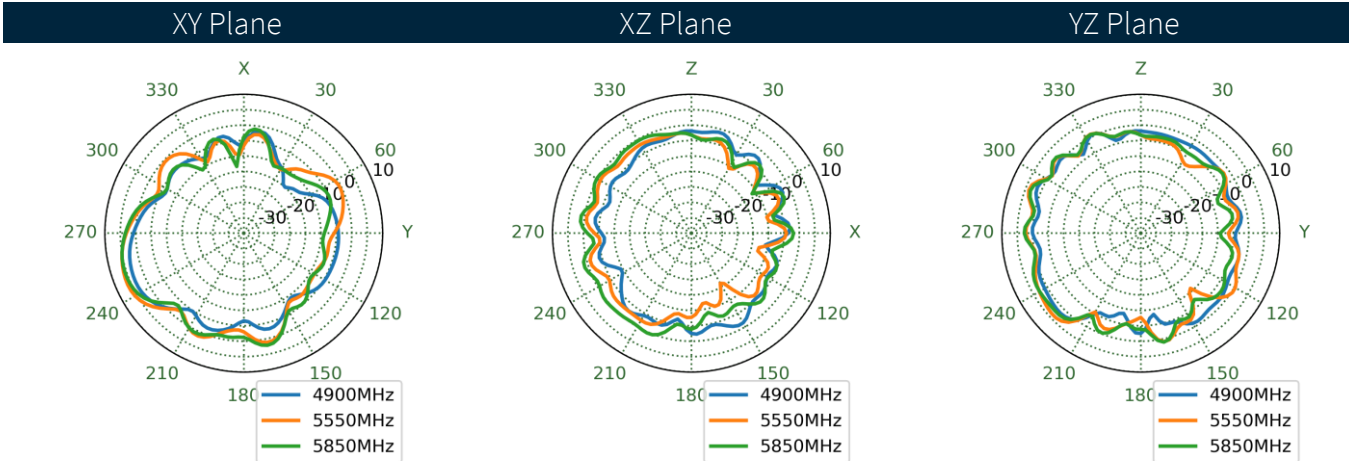
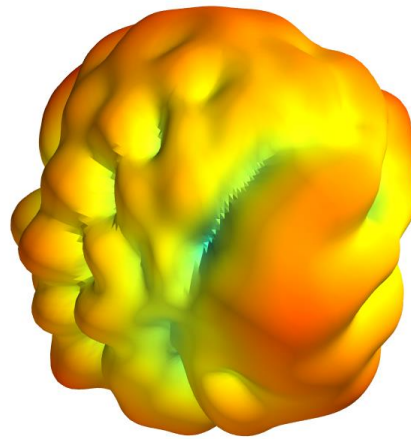

5. Mechanical Drawing (Units: mm)

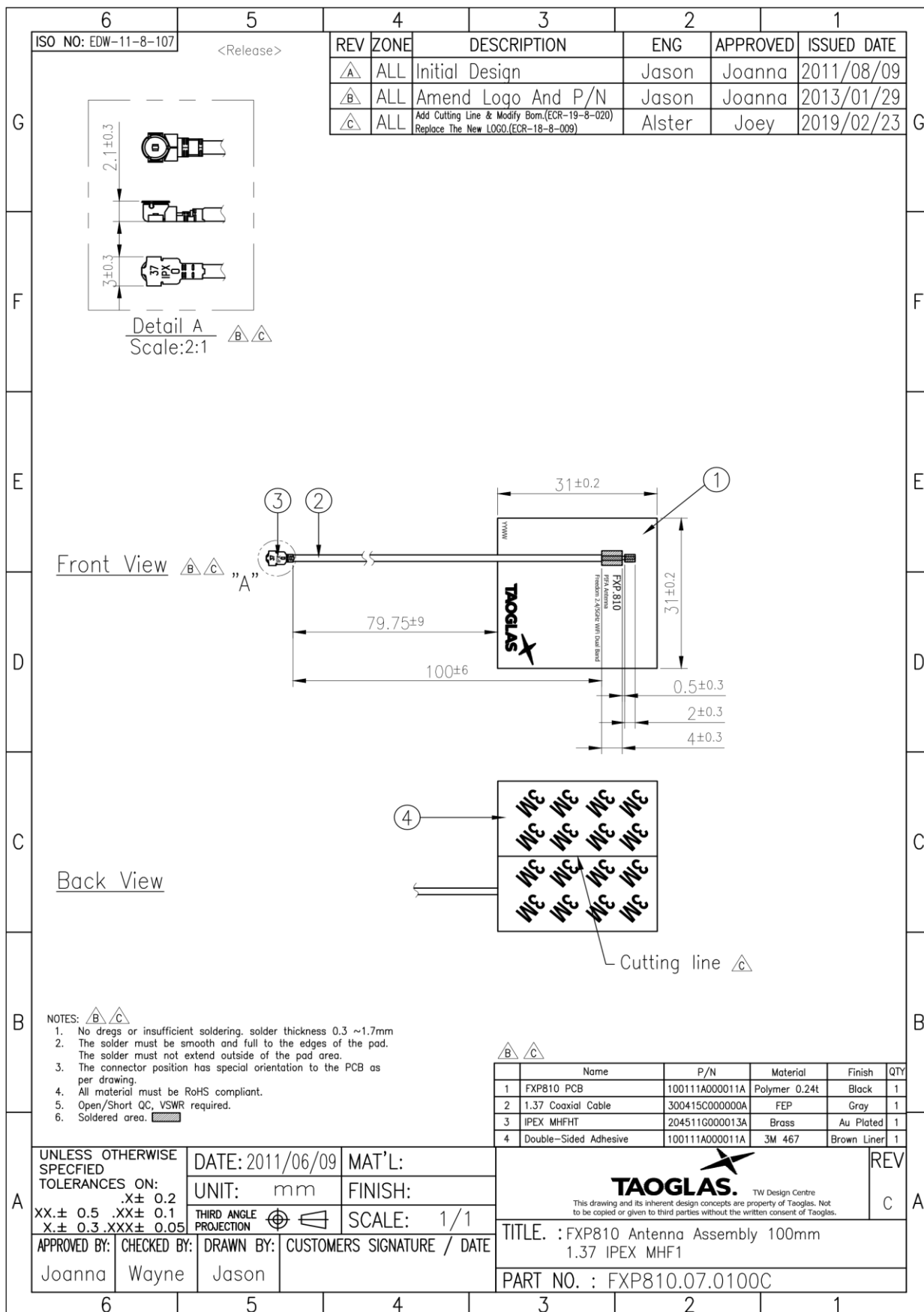

6. Packaging

1 pc FXP810.07.0100C in PE Bag
 Dimensions - 150 x 100mm
 Weight - 2g

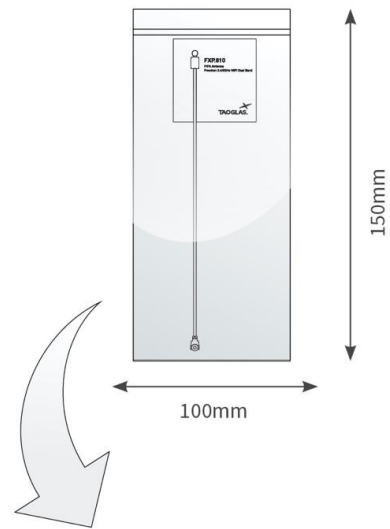

100pc FXP810.07.0100C per large PE Bag
 Dimensions - 200 x 250mm
 Weight - 220g

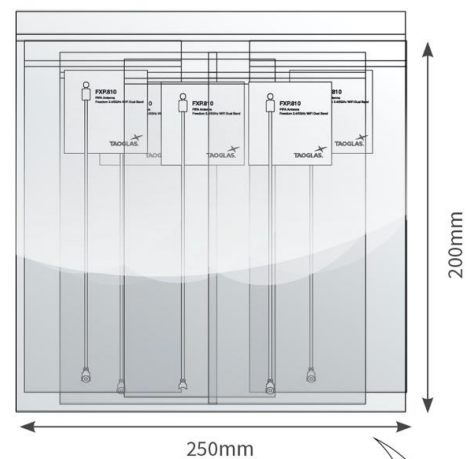

2000 pcs FXP810.07.0100C per carton
 20 Large PE Bags per carton
 Carton Dimensions - 230 x 175 x 160mm
 Weight - 2.7Kg

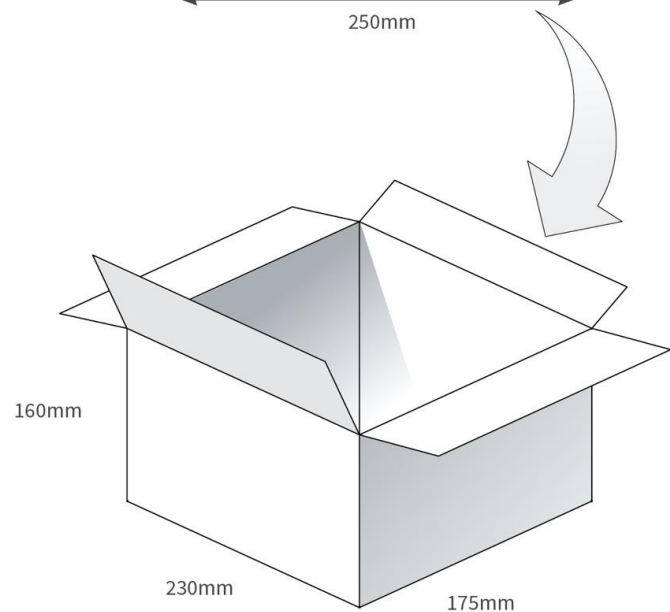

Changelog for the datasheet

SPE-11-8-050 – FXP810.07.0100C

Revision: G (Current Version)

Date:	2021-11-19
Changes:	Full datasheet template update, new data & new packaging info.
Changes Made by:	Gary West

Previous Revisions

Revision: F

Date:	2016-12-15
Changes:	Updated patent pending and added disclaimer.
Changes Made by:	Andy Mahoney

Revision: A (Original First Release)

Date:	2010-03-22
Notes:	
Author:	Unknown

Revision: E

Date:	2016-04-26
Changes:	chnaged from Dipole to PIFA.
Changes Made by:	Aine Doyle

Revision: D

Date:	2015-01-14
Changes:	Added note on Intro.
Changes Made by:	Aine Doyle

Revision: C

Date:	2011-07-26
Changes:	
Changes Made by:	Unknown

Revision: B

Date:	2010-07-29
Changes:	
Changes Made by:	Unknown



TAOGLAS®

www.taoglas.com

