

# General Specifications

Toggles

Rockers  
B

Pushbuttons

Illuminated PB

Programmable

Keylocks

Rotaries

Slides

Tactiles

Tilt

Touch

Indicators

Accessories

Supplement

## Electrical Capacity (Resistive Load)

**Logic Level:** 0.4VA maximum @ 28V AC/DC maximum  
(Applicable Range 0.1mA ~ 0.1A @ 20mV ~ 28V)  
Note: Find additional explanation of operating range in Supplement section.

## Other Ratings

**Contact Resistance:** 80 milliohms maximum  
**Insulation Resistance:** 500 megohms minimum @ 500V DC  
**Dielectric Strength:** 500V AC minimum for 1 minute minimum  
**Mechanical Life:** 50,000 operations minimum  
**Electrical Life:** 50,000 operations minimum  
**Nominal Operating Force:** For Rockers 1.70N; for Paddles 1.30N  
**Angle of Throw:** 28°

## Materials & Finishes

**Actuator:** Glass fiber reinforced polyamide (UL94V-0)  
**Case:** Glass fiber reinforced polyamide (UL94V-0)  
**Sealing Ring:** Nitrile butadiene rubber  
**Movable Contact:** Phosphor bronze with gold plating  
**Stationary Contacts:** Phosphor bronze with gold plating  
**Base:** Glass fiber reinforced polyamide (UL94V-0)  
**Mounting Bracket:** Phosphor bronze with tin plating  
**Terminals:** Phosphor bronze with gold plating

## Environmental Data

**Operating Temperature Range:** -30°C through +85°C (-22°F through +185°F)  
**Humidity:** 90 ~ 95% humidity for 240 hours @ 40°C (104°F)  
**Vibration:** 10 ~ 55Hz with peak-to-peak amplitude of 1.5mm traversing the frequency range & returning in 1 minute; 3 right angled directions for 2 hours  
**Shock:** 50G (490m/s<sup>2</sup>) acceleration (tested in 6 right angled directions, with 5 shocks in each direction)

## PCB Processing

**Soldering:** Wave Soldering Recommended: See Profile A in Supplement section.  
Manual Soldering: See Profile A in Supplement section..  
**Cleaning:** These devices are not process sealed. Hand clean locally using alcohol based solution.

## Standards & Certifications

**Flammability Standards:** UL94V-0 actuator & case/base

The GW Series rockers have not been tested for UL recognition or CSA certification. These switches are designed for use in a low-voltage, low-current, logic-level circuit. When used as intended in a logic-level circuit, the results do not produce hazardous energy.

# Distinctive Characteristics

Various colored rockers and paddles.

Combination of dust cover and closely fit housing, actuator, and interior pivot provides protection for contacts.

Detent mechanism design of coil spring, plunger, and plastic detent results in crisp and positive actuation.

Extremely thin size allows high density PCB mounting and makes these switches ideal for handheld equipment.

Award-winning STC contact mechanism with benefits unavailable in conventional mechanisms: smoother, positive detent actuation, increased contact stability and unparalleled logic-level reliability. (Additional STC details in Terms & Acronyms; see Supplement section.)

Molded-in, epoxy sealed terminals lock out flux and other contaminants.

.100" x .100" (2.54mm x 2.54mm) terminal spacing conforms to standard PC board grid spacing for straight and angle mounting.



Actual Size

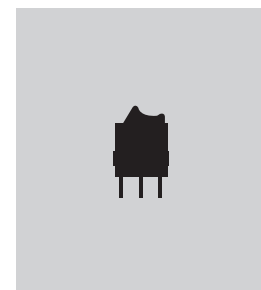

## TYPICAL SWITCH ORDERING EXAMPLE

**GW**      **1**      **2**      **R**      **C**      **P**

Poles		Circuit			Actuators		Actuator Colors		PC Terminals		
1	SPDT	2	ON	NONE	ON	R	Rocker	B	White	P	Straight
2	DPDT					L	Paddle	C	Red	H	Right Angle
								H	Gray	V	Vertical

## DESCRIPTION FOR TYPICAL ROCKER ORDERING EXAMPLE

### GW12RCP

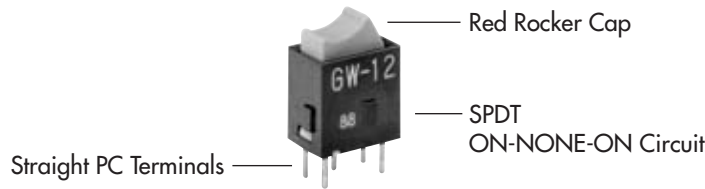

## POLES & CIRCUIT

Pole	Model	Rocker Position			Connected Terminals			Throw & Schematics
		Up	Center	Down	Up	Center	Down	
SP	GW12	ON	NONE	ON	5-6	OPEN	5-4	SPDT 
DP	GW22	ON	NONE	ON	5-6 2-3	OPEN	5-4 2-1	DPDT 

Note: Terminal numbers are not actually on the switch.

## TYPICAL SWITCH DIMENSIONS

### Straight PC



GW12RCP

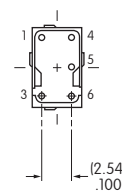
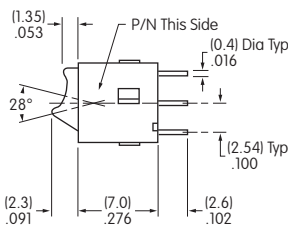
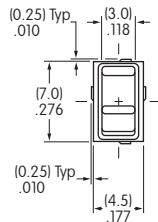

### Single Pole

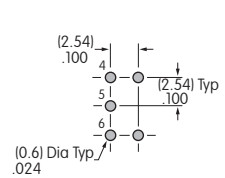

On single pole models positions 1 & 3 are support pins.

### Straight PC



GW22LCP

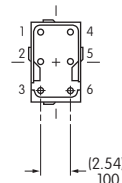
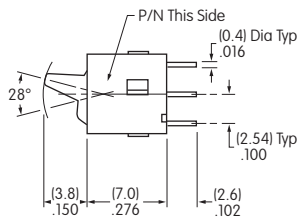
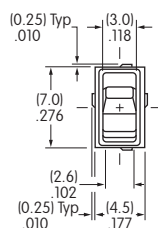

### Double Pole

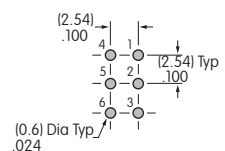

## TYPICAL SWITCH DIMENSIONS

### Single Pole

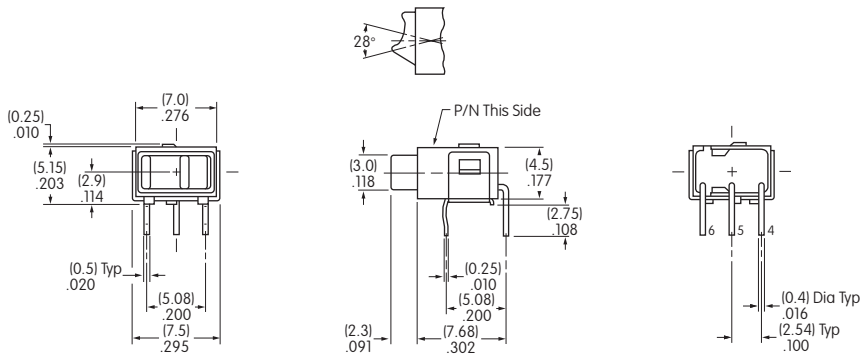

### Right Angle PC

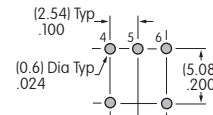

**GW12RCH**

### Double Pole

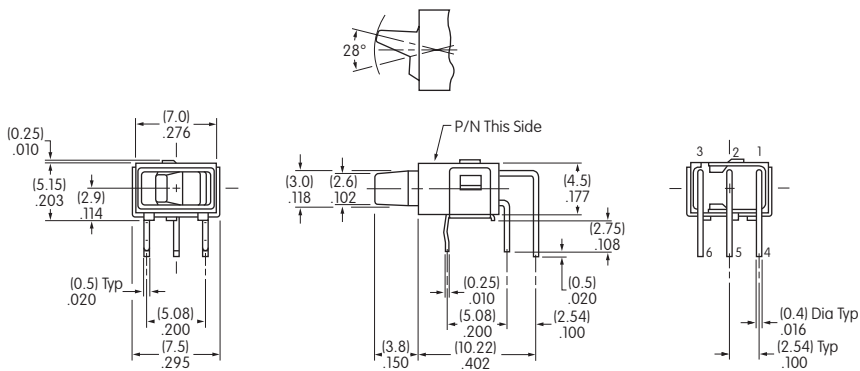

### Right Angle PC

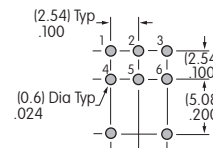

**GW22LCH**

### Single Pole

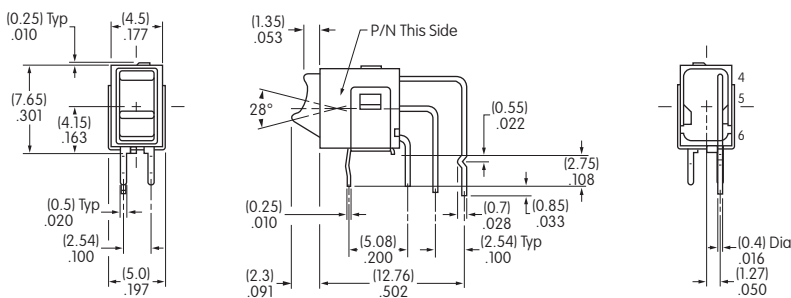

### Vertical PC

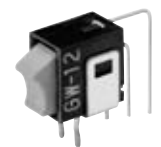
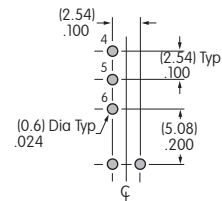

**GW12RCV**

### Double Pole

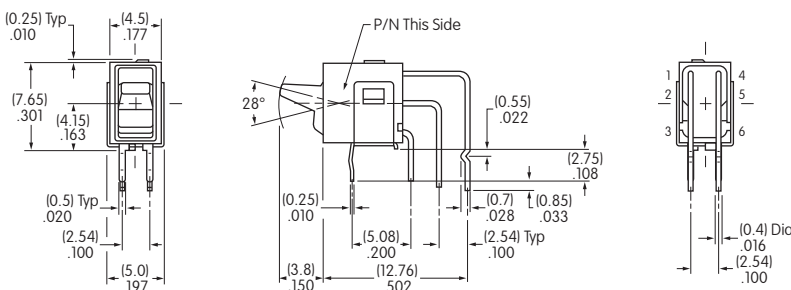

### Vertical PC

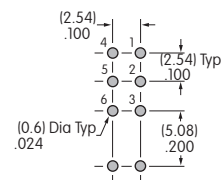

**GW22LCV**