

Check valves H/HA/HB/HGL

FESTO



Festo core product range
Covers 80% of your automation tasks

Worldwide:

Always in stock

Superb:

Festo quality at an attractive price

Easy:

Reduces procurement and storing complexity

★ Ready for dispatch from the Festo factory in 24 hours
Held in stock in 13 service centres worldwide
More than 2200 products

★ Ready for dispatch in 5 days maximum from stock
Assembled for you in 4 service centres worldwide
Up to 6 x 10¹² variants per product series

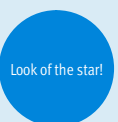

Check valves H/HA/HB/HGL

Product range overview

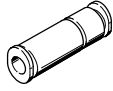
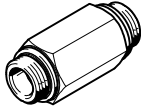
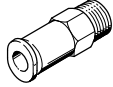
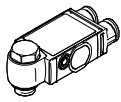
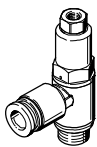
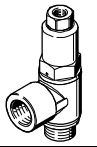
Version	Valve function	Version	Type	Pneumatic connection 1	Pneumatic connection 2	qnN [l/min]	→ Page/ Internet
Check valves							
Compact design							
	Non-return function		H	QS-4, QS-6, QS-8, QS-10, QS-12	QS-4, QS-6, QS-8, QS-10, QS-12	136 ... 1,715	4
				M5, G1/8, G1/4, G3/8, G1/2, G3/4	M5, G1/8, G1/4, G3/8, G1/2, G3/4	115 ... 5,900	5
	Non-return function		HA	M5, R1/8, R1/4, R3/8, R1/2	QS-4, QS-6, QS-8, QS-10, QS-12	138 ... 2,230	7
			HB	QS-4, QS-6, QS-8, QS-10, QS-12	M5, R1/8, R1/4, R3/8, R1/2	142 ... 2,206	7
Flat design							
	Piloted non-return function		VBNF	QS-6, QS-8	G1/8, G1/4	260 ... 620	vbnf
Piloted check valves							
Compact design							
	Piloted non-return function		HGL	QS-4, QS-6, QS-8, QS-10, QS-12	M5, G1/8, G1/4, G3/8, G1/2	130 ... 1,400	9
				M5, G1/8, G1/4, G3/8, G1/2	M5, G1/8, G1/4, G3/8, G1/2	130 ... 1,600	12

Check valves H/HA/HB/HGL

Type codes

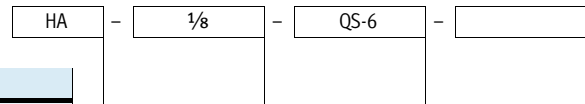

Type	
Non-return function	
H	Check valve
HA	Check valve, flow direction: male thread → push-in connector QS
HB	Check valve, flow direction: push-in connector QS → male thread
Piloted non-return function	
HGL	Piloted check valve

**Pneumatic connection 1 with H/HA,
pneumatic connection 2 with HB/HGL**

H	
QS-4	Push-in connector for tubing O.D. 4 mm
QS-6	Push-in connector for tubing O.D. 6 mm
QS-8	Push-in connector for tubing O.D. 8 mm
QS-10	Push-in connector for tubing O.D. 10 mm
QS-12	Push-in connector for tubing O.D. 12 mm
M5	Female thread M5
1/8-A/I	Male thread/female thread G1/8
1/4	Male thread G1/4
3/8	Male thread G3/8
1/2	Male thread G1/2
3/4	Male thread G3/4
HA/HB	
M5	Male thread M5
1/8	Male thread R1/8
1/4	Male thread R1/4
3/8	Male thread R3/8
1/2	Male thread R1/2
HGL	
M5	Male thread M5
1/8	Male thread G1/8
1/4	Male thread G1/4
3/8	Male thread G3/8
1/2	Male thread G1/2

**Pneumatic connection 2 with H/HA,
pneumatic connection 1 with HB/HGL**

H/HGL	
–	Connection size as for connection 1 or 2
HA/HB/HGL	
QS-4	Push-in connector for tubing O.D. 4 mm
QS-6	Push-in connector for tubing O.D. 6 mm
QS-8	Push-in connector for tubing O.D. 8 mm
QS-10	Push-in connector for tubing O.D. 10 mm
QS-12	Push-in connector for tubing O.D. 12 mm

Generation	
B	B series



Check valves H

Technical data – Push-in connector QS

FESTO

Non-return function



-  - Flow rate
136 ... 1,715 l/min
-  - Temperature range
0 ... +60 °C
-  - Operating pressure
-1 ... +10 bar



General technical data					
Valve function	Non-return function				
Pneumatic connection 1	QS-4	QS-6	QS-8	QS-10	QS-12
Pneumatic connection 2	QS-4	QS-6	QS-8	QS-10	QS-12
Type of mounting	In-line installation				
Mounting position	Any				

Operating and environmental conditions			
Operating pressure	[bar]	-1 ... +10	
Minimal differential pressure	open	[bar]	≥ 0.1
	close	[bar]	≥ 0.2
Operating medium	Compressed air in accordance with ISO 8573-1:2010 [7:--]		
Note on operating/pilot medium	Operation with lubricated medium possible (in which case lubricated operation will always be required)		
Ambient temperature	[°C]	0 ... +60	

Materials	
Housing	Aluminium
Note on materials	RoHS-compliant
	Free of copper and PTFE

Dimensions Download CAD data → www.festo.com

← Flow direction

Type	Tubing O.D. D1	D2 Ø	L
H-QS-4	4	9	34.8
H-QS-6	6	12	38.8
H-QS-8	8	15	54.9
H-QS-10	10	25	73.4
H-QS-12	12	25	78.6

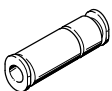
	Pneumatic connection		Standard nominal flow rate qnN [l/min]	Weight [g]	Part No.	Type
	1	2				
	QS-4	QS-4	136	5.3	153462	H-QS-4
	QS-6	QS-6	282	10	153463	H-QS-6
	QS-8	QS-8	681	21	153464	H-QS-8
	QS-10	QS-10	1,480	63	153465	H-QS-10
	QS-12	QS-12	1,715	69	153466	H-QS-12



Check valves H

Technical data – Female/male thread

FESTO

Non-return function



-  - Flow rate
115 ... 5,900 l/min
-  - Temperature range
-10 ... +60 °C
-  - Operating pressure
0.4 ... 12 bar



General technical data						
Valve function	Non-return function					
Pneumatic connection 1	M5	G1/8	G1/4	G3/8	G1/2	G3/4
Pneumatic connection 2	M5	G1/8	G1/4	G3/8	G1/2	G3/4
Type of mounting	In-line installation			Screw-in		
Mounting position	Any					
Nominal tightening torque [Nm]	-	-	11 ±10%	12.5 ±20%	14 ±20%	35 ±10%

-  - Note: This product conforms to ISO 1179-1 and to ISO 228-1

Operating and environmental conditions						
Pneumatic connection 1	M5	G1/8	G1/4	G3/8	G1/2	G3/4
Operating pressure complete [bar]	0.4 ... 8		0.4 ... 12			
Operating medium	Compressed air in accordance with ISO 8573-1:2010 [7:-:-]		Compressed air in accordance with ISO 8573-1:2010 [7:4:4]			
Note on operating/pilot medium	Operation with lubricated medium possible (in which case lubricated operation will always be required)					
Ambient temperature [°C]	-10 ... +60					
Temperature of medium [°C]	-10 ... +60					
Storage temperature [°C]	-		-10 ... +60			
Corrosion resistance class CRC ¹⁾	-		2			

1) Corrosion resistance class CRC 2 to Festo standard FN 940070
Moderate corrosion stress. Indoor applications in which condensation may occur. External visible parts with primarily decorative requirements for the surface and which are in direct contact with the ambient atmosphere typical for industrial applications.

Materials						
Pneumatic connection 1	M5	G1/8	G1/4	G3/8	G1/2	G3/4
Housing	Brass		Anodised wrought aluminium alloy			
Seals	NBR					
Note on materials	RoHS-compliant	-	RoHS-compliant			
	-		Free of copper and PTFE			

Check valves H

Technical data – Female/male thread

FESTO

Dimensions Download CAD data → www.festo.com

H-M5

→ Flow direction

H-1/8-A/I

→ Flow direction

H-1/4-B ... H-3/4-B

→ Flow direction

Type	Connection D1	L1	L2	L3	⌀
H-M5	M5	20	4	7	11
H-1/8-A/I	G1/8	28.5	7.5	6.5	13
H-1/4-B	G1/4	48	32	8	19
H-3/8-B	G3/8	50	32	9	22
H-1/2-B	G1/2	65	44	10.5	27
H-3/4-B	G3/4	74	50	12	32

• Note: This product conforms to ISO 1179-1 and to ISO 228-1

	Pneumatic connection		Standard nominal flow rate q _N [l/min]	Weight [g]	Part No.	Type
	1	2				
	M5	M5	115	15	3671	H-M5
	G1/8	G1/8	280	21	3324	H-1/8-A/I¹⁾
	G1/4	G1/4	1,000	25.4	11689	H-1/4-B¹⁾
	G3/8	G3/8	2,000	34	11690	H-3/8-B¹⁾
	G1/2	G1/2	5,500	58.3	11691	H-1/2-B¹⁾
	G3/4	G3/4	5,900	101	11692	H-3/4-B¹⁾



1) Sealing rings for male thread are included in the scope of delivery.

Check valves HA/HB

Technical data

Non-return function



-  - Flow rate
138 ... 2,230 l/min
-  - Temperature range
0 ... +60 °C
-  - Operating pressure
-1 ... +10 bar



General technical data											
Valve function	Non-return function										
Type	HA					HB					
Pneumatic connection 1	M5	R1/8	R1/4	R3/8	R1/2	QS-4	QS-6	QS-8	QS-10	QS-12	
Pneumatic connection 2	QS-4	QS-4, QS-6, QS-8	QS-6, QS-8	QS-10, QS-12	QS-12	M5, R1/8	R1/8, R1/4	R1/8, R1/4	R3/8	R3/8, R1/2	
Type of mounting	Screw-in										
Mounting position	Any										

Operating and environmental conditions		
Operating pressure	[bar]	-1 ... +10
Minimal differential pressure	open [bar]	≥ 0.1
	close [bar]	≥ 0.2
Operating medium	Compressed air in accordance with ISO 8573-1:2010 [7:-:-]	
Note on operating/pilot medium	Operation with lubricated medium possible (in which case lubricated operation will always be required)	
Ambient temperature	[°C]	0 ... +60

Materials	
Housing	Nickel-plated brass
Note on materials	RoHS-compliant

Check valves HA/HB

Technical data

FESTO

Dimensions Download CAD data → www.festo.com

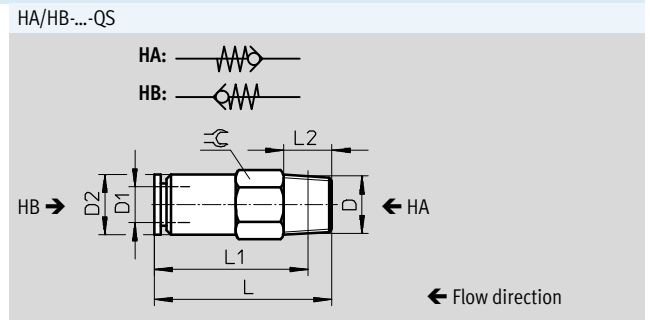
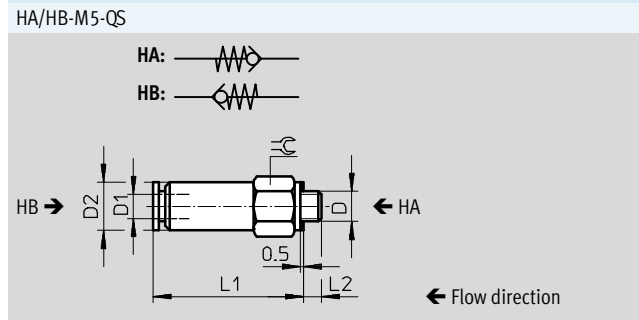

Type	Connection D	Tubing O.D. D1	D2 Ø	L	L1	L2	⌀
HA/HB-M5-QS-4	M5	4	8	–	25.4	3	8
HA/HB-1/8-QS-4	R1/8	4	9	24.5	20.5	8	10
HA/HB-1/8-QS-6		6	10	29.3	25.3	8	10
HA/HB-1/8-QS-8		8	13.5	35.5	31.5	8	14
HA/HB-1/4-QS-6	R1/4	6	12	29.3	23.3	11	14
HA/HB-1/4-QS-8		8	13.5	39.2	33.2	11	14
HA/HB-3/8-QS-10	R3/8	10	25	61.7	55.4	12	24
HA/HB-3/8-QS-12		12	25	64.3	58	12	24
HA/HB-1/2-QS-12	R1/2	12	28	70.8	62.6	15	27

Ordering data		Pneumatic connection		Standard nominal flow rate qnN	Weight	Part No.	Type
		1	2	[l/min]	[g]		
Flow direction: male thread → push-in connector QS							
	M5	QS-4	148	7.2	153444	HA-M5-QS-4	
	R1/8	QS-4	138	11	153446	HA-1/8-QS-4	
		QS-6	311	11	153448	HA-1/8-QS-6	
		QS-8	331	22	153452	HA-1/8-QS-8	
	R1/4	QS-6	302	23	153450	HA-1/4-QS-6	
		QS-8	670	24	153454	HA-1/4-QS-8	
	R3/8	QS-10	1,740	47	153456	HA-3/8-QS-10	
		QS-12	1,876	50	153458	HA-3/8-QS-12	
R1/2	QS-12	2,230	69	153460	HA-1/2-QS-12		
Flow direction: push-in connector QS → male thread							
	QS-4	M5	144	7.2	153445	HB-M5-QS-4	
		R1/8	142	11	153447	HB-1/8-QS-4	
	QS-6	R1/8	335	11	153449	HB-1/8-QS-6	
		R1/4	294	23	153451	HB-1/4-QS-6	
	QS-8	R1/8	314	22	153453	HB-1/8-QS-8	
		R1/4	696	24	153455	HB-1/4-QS-8	
	QS-10	R3/8	1,700	47	153457	HB-3/8-QS-10	
	QS-12	R3/8	1,886	50	153459	HB-3/8-QS-12	
R1/2		2,206	69	153461	HB-1/2-QS-12		

Piloted check valves HGL

Technical data – Push-in connector QS

Function

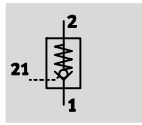

- - Flow rate
130 ... 1,400 l/min
- - Temperature range
-10 ... +60 °C
- - Operating pressure
0.5 ... 10 bar



The piloted check valve is suitable for short-duration positioning and braking functions in pneumatic drives. Compressed air flows to and from the drive as long as a pilot signal is

applied to pneumatic connection 21. If no pilot signal is applied, the valve shuts off the exhaust air from the drive in flow direction 2 → 1 and the movement of the drive is stopped.

- Proven component suitable for use in safety-related systems
- Swivel connection can be swivelled after mounting
- Manual exhausting of air trapped in the cylinder with manual override HAB → 15 as an accessory

General technical data						
Pneumatic connection 2	M5	G1/8	G1/4	G3/8	G1/2	
Pneumatic connection 1	QS-4	QS-4, QS-6	QS-8, QS-10	QS-8, QS-10	QS-12	
Pilot air connection 21	QS-4	M5	G1/8	G1/4	G3/8	
Valve function	Piloted non-return function					
Actuation type	Pneumatic					
Type of mounting	Screw-in, via male thread					
Mounting position	Any					
Nominal tightening torque [Nm]	1.25 ±10%	3.5 ±10%	11 ±10%	12.5 ±10%	14 ±10%	

- - Note: This product conforms to ISO 1179-1 and to ISO 228-1

Operating and environmental conditions						
Pneumatic connection 2	M5	G1/8	G1/4	G3/8	G1/2	
Operating pressure complete temperature range [bar]	0.5 ... 10					
Pilot pressure [bar]	2 ... 10			1 ... 10		
Operating/pilot medium	Compressed air in accordance with ISO 8573-1:2010 [7:4:4]					
Note on operating/pilot medium	Operation with lubricated medium possible (in which case lubricated operation will always be required)					
Ambient temperature [°C]	-10 ... +60					
Temperature of medium [°C]	-10 ... +60					
Storage temperature [°C]	-10 ... +60					
Corrosion resistance class CRC ¹⁾	2					

1) Corrosion resistance class CRC 2 to Festo standard FN 940070

Moderate corrosion stress. Indoor applications in which condensation may occur. External visible parts with primarily decorative requirements for the surface and which are in direct contact with the ambient atmosphere typical for industrial applications.



Note

Additional measures are required for use in safety-related applications; in Europe, for example, the standards listed under the EC Machinery Directive must be observed.

Without additional measures in accordance with statutory minimum requirements, the product is not suitable for use in safety-related sections of control systems.

Piloted check valves HGL

Technical data – Push-in connector QS

Minimum pilot pressure p21 as a function of operating pressure p1

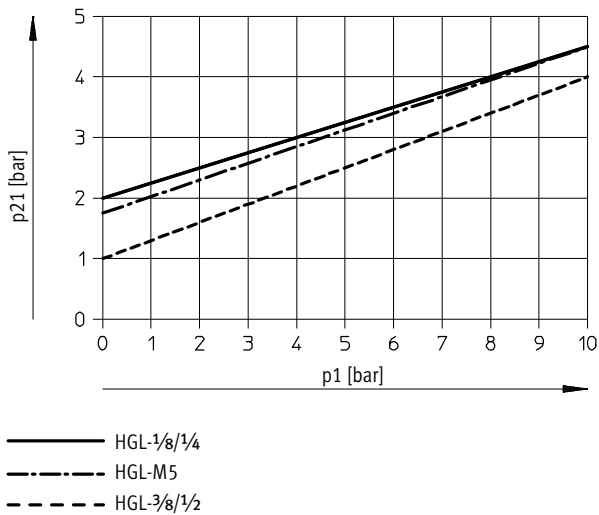

Materials

Sectional view

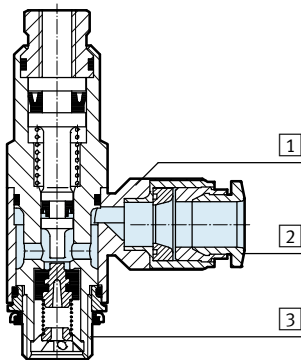

Piloted check valve		
1	Swivel connection	Die-cast zinc
2	Releasing ring	POM
3	Hollow bolt	Anodised wrought aluminium alloy
-	Seals, non-return collar	NBR
Note on materials		RoHS-compliant
		Free of copper and PTFE

Piloted check valves HGL

Technical data – Push-in connector QS

FESTO

Dimensions

Download CAD data → www.festo.com

HGL-M5

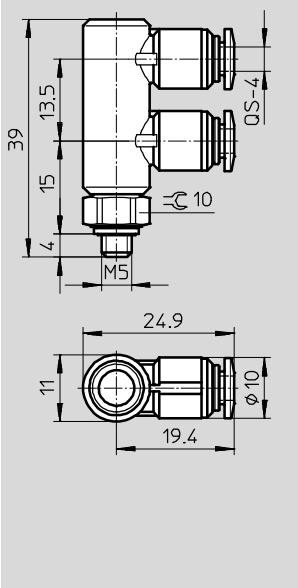

HGL-1/8, HGL-1/4, HGL-3/8

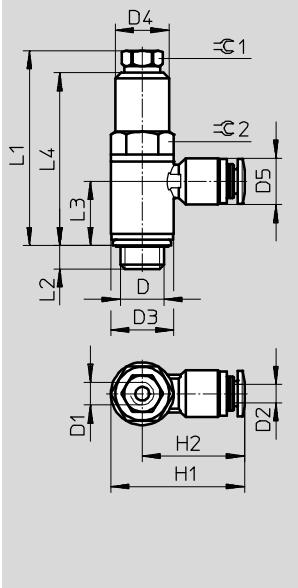

HGL-1/2

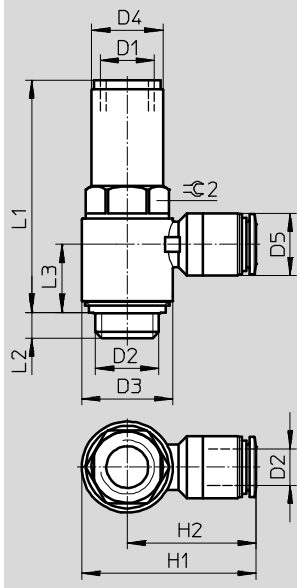

Type	Connection D	Tubing O.D. D2	D1	D3 Ø	D4 Ø	D5 Ø	H1	H2	L1	L2	L3	L4	∅C 1	∅C 2
HGL-1/8-QS-4	G1/8	4	M5	13.8	11.8	10.2	29.4	22.5	42.6	5.4	13.9	37.8	8	12
HGL-1/8-QS-6	G1/8	6				12.5	32.6	25.7			13.2			
HGL-1/4-QS-8	G1/4	8	G1/8	17.8	16	14.5	39.6	30.7	50.8	6.5	16.6	44.5	12	16
HGL-1/4-QS-10	G1/4	10				17.5	42	33.1			15.5			
HGL-3/8-QS-8	G3/8	8	G1/4	22.4	18.8	14.5	44.1	32.9	56.3	7	18.2	49.5	15	19
HGL-3/8-QS-10	G3/8	10				17.5	46.7	35.5			18.2			
HGL-1/2-QS-12	G1/2	12	G3/8	27.8	23.5	20.5	55.3	41.4	75.8	8.8	22.4	-	-	24

Note: This product conforms to ISO 1179-1 and to ISO 228-1

★ Core product range

	Pneumatic connection		Pilot air connection	Standard nominal flow rate qnN at 6 → 5 bar [l/min]	Standard flow rate qn at 6 → 0 bar [l/min]	Weight [g]	Part No.	Type
	2	1						
	M5	QS-4	QS-4	130	200	21	★ 530038	HGL-M5-QS-4 ¹⁾
	G1/8	QS-4	M5	200	300	18.4	★ 530039	HGL-1/8-QS-4 ¹⁾
		QS-6	M5	270	400	21.4	★ 530040	HGL-1/8-QS-6 ¹⁾
	G1/4	QS-8	G1/8	390	640	38.7	★ 530041	HGL-1/4-QS-8 ¹⁾
		QS-10	G1/8	400	670	45	★ 530042	HGL-1/4-QS-10 ¹⁾
	G3/8	QS-8	G1/4	830	1,200	54.7	★ 530043	HGL-3/8-QS-8 ¹⁾
		QS-10	G1/4	890	1,300	60.3	★ 530044	HGL-3/8-QS-10 ¹⁾
G1/2	QS-12	G3/8	1,400	2,100	116.9	★ 530045	HGL-1/2-QS-12 ¹⁾	

1) Sealing ring for male thread is included in the scope of delivery.

Festo core product range

- ★ Ready for dispatch from the Festo factory in 24 hours
- ☆ Ready for dispatch in 5 days maximum from stock



Piloted check valves HGL

Technical data – Female thread

FESTO

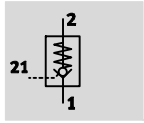
Function



-  - Flow rate
130 ... 1,600 l/min
-  - Temperature range
-10 ... +60 °C
-  - Operating pressure
0.5 ... 10 bar



The piloted check valve is suitable for short-duration positioning and braking functions in pneumatic drives. Compressed air flows to and from the drive as long as a pilot signal is

applied to pneumatic connection 21. If no pilot signal is applied, the valve shuts off the exhaust air from the drive in flow direction 2 → 1 and the movement of the drive is stopped.

- Proven component suitable for use in safety-related systems
- Swivel connection can be swivelled after mounting
- Manual exhausting of air trapped in the cylinder with manual override HAB → 15 as an accessory

General technical data						
Pneumatic connection 2		M5	G1/8	G1/4	G3/8	G1/2
Pneumatic connection 1		M5	G1/8	G1/4	G3/8	G1/2
Pilot air connection 21		M5	M5, G1/8	G1/8	G1/4	G3/8
Valve function		Piloted non-return function				
Actuation type		Pneumatic				
Type of mounting		Screw-in, via male thread				
Mounting position		Any				
Nominal tightening torque [Nm]		1.25 ±10%	3.5 ±10%	11 ±10%	12.5 ±10%	14 ±10%

• Note: This product conforms to ISO 1179-1 and to ISO 228-1

Operating and environmental conditions						
Pneumatic connection 2		M5	G1/8	G1/4	G3/8	G1/2
Operating pressure complete temperature range	[bar]	0.5 ... 10				
Pilot pressure	[bar]	2 ... 10			1 ... 10	
Operating/pilot medium		Compressed air in accordance with ISO 8573-1:2010 [7:4:4]				
Note on operating/pilot medium		Operation with lubricated medium possible (in which case lubricated operation will always be required)				
Ambient temperature	[°C]	-10 ... +60				
Temperature of medium	[°C]	-10 ... +60				
Storage temperature	[°C]	-10 ... +60				
Corrosion resistance class CRC ¹⁾		2				

1) Corrosion resistance class CRC 2 to Festo standard FN 940070
Moderate corrosion stress. Indoor applications in which condensation may occur. External visible parts with primarily decorative requirements for the surface and which are in direct contact with the ambient atmosphere typical for industrial applications.

 - Note

Additional measures are required for use in safety-related applications; in Europe, for example, the standards listed under the EC Machinery Directive must be observed.

Without additional measures in accordance with statutory minimum requirements, the product is not suitable for use in safety-related sections of control systems.

Piloted check valves HGL

Technical data – Female thread

Minimum pilot pressure p_{21} as a function of operating pressure p_1

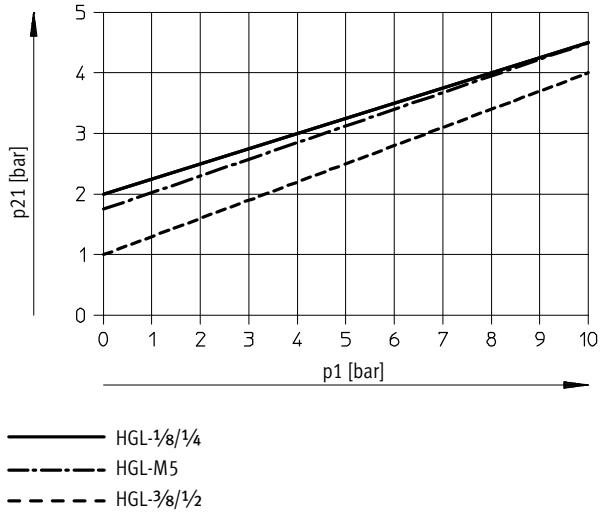

Materials

Sectional view

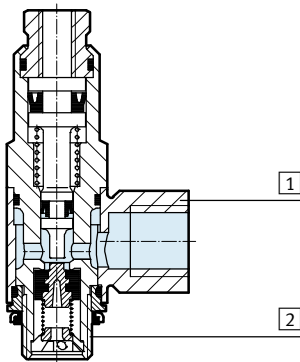

Piloted check valve	
1 Swivel connection	Die-cast zinc
2 Hollow bolt	Anodised wrought aluminium alloy
– Seals, non-return collar	NBR
Note on materials	RoHS-compliant
	Free of copper and PTFE

Piloted check valves HGL

Technical data – Female thread

FESTO

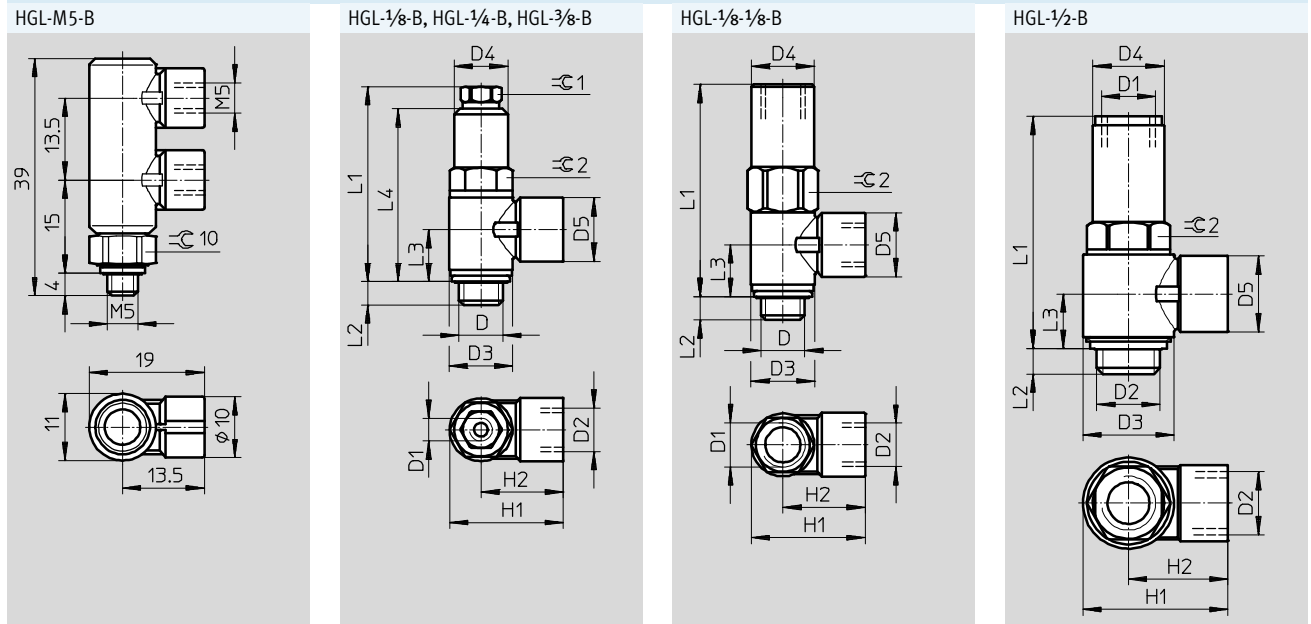

Dimensions Download CAD data → www.festo.com



Type	Connection D	Connection D2	D1	D3 Ø	D4 Ø	D5 Ø	H1	H2	L1	L2	L3	L4	∅ 1	∅ 2
HGL-1/8-B	G1/8	G1/8	M5	14	11.8	14	25.1	18.1	42.6	5.4	11.2	37.8	8	12
HGL-1/8-1/8-B	G1/8	G1/8	G1/8	14	13.8	14	25.1	18.1	46.7	5.2	11.2	-	-	14
HGL-1/4-B	G1/4	G1/4	G1/8	18	16	17.5	34	25	50.8	6.5	13.5	44.5	12	16
HGL-3/8-B	G3/8	G3/8	G1/4	23.8	18.8	20	39.3	27.4	56.3	7	15.1	49.5	15	19
HGL-1/2-B	G1/2	G1/2	G3/8	30	23.5	25	47.8	32.8	75.8	8.8	17.7	-	-	24

• Note: This product conforms to ISO 1179-1 and to ISO 228-1

★ Core product range

Ordering data	Pneumatic connection		Pilot air connection	Standard nominal flow rate qnN at 6 → 5 bar [l/min]	Standard flow rate qn at 6 → 0 bar [l/min]	Weight [g]	Part No.	Type
	2	1						
	M5	M5	M5	130	200	21	★ 530029	HGL-M5-B ¹⁾
	G1/8	G1/8	M5	300	430	20.8	★ 530030	HGL-1/8-B ¹⁾
			G1/8	300	430	26.2	★ 543253	HGL-1/8-1/8-B ¹⁾
	G1/4	G1/4	G1/8	550	680	41.2	★ 530031	HGL-1/4-B ¹⁾
	G3/8	G3/8	G1/4	1,100	1,500	62.9	★ 530032	HGL-3/8-B ¹⁾
	G1/2	G1/2	G3/8	1,600	2,100	129.4	★ 530033	HGL-1/2-B ¹⁾

1) Sealing ring for male thread is included in the scope of delivery.

Festo core product range

- ★ Ready for dispatch from the Festo factory in 24 hours
- ☆ Ready for dispatch in 5 days maximum from stock

Piloted check valves HGL

Accessories

Manual override HAB
for piloted check valve HGL

- For manual exhausting of air trapped in a cylinder

Material:
Housing: Anodised wrought aluminium alloy

Note on materials:
RoHS-compliant



General technical data				
Pneumatic connection 2	G1/8	G1/4	G3/8	G1/2
Pneumatic connection 1	G1/8	G1/4	G3/8	G1/2
Nominal size [mm]	4.1	7	11	14
Valve function	Exhaust component			
Type of mounting	Screw-in			
Mounting position	Any			
Standard flow rate, exhausting, at 6 → 0 bar [l/min]	165			
Max. tightening torque [Nm]	4	11	40	50

Operating and environmental conditions	
Operating pressure [bar]	0 ... 10
Operating medium	Compressed air in accordance with ISO 8573-1:2010 [7:4:4]
Note on operating/pilot medium	Operation with lubricated medium possible (in which case lubricated operation will always be required)
Ambient temperature [°C]	-20 ... +80
Temperature of medium [°C]	-20 ... +80
Corrosion resistance class CRC ¹⁾	2

1) Corrosion resistance class CRC 2 to Festo standard FN 940070
Moderate corrosion stress. Indoor applications in which condensation may occur. External visible parts with primarily decorative requirements for the surface and which are in direct contact with the ambient atmosphere typical for industrial applications.

Dimensions

Download CAD data → www.festo.com

Dimensions and ordering data									
Connection	B1	D2	L1	L2	L3	L4	⌀	Part No.	Type
D1		∅							
G1/8	6.2	7.7	4.7	1.8	19.1	5	13	184585	HAB-1/8
G1/4	6.2	7.7	5.8	2.2	28	7	17	184586	HAB-1/4
G3/8	6.2	7.7	6.05	3.35	28.4	7	19	184587	HAB-3/8
G1/2	6.2	7.7	7.9	2.6	38.5	7	24	184588	HAB-1/2

• Note: This product conforms to ISO 1179-1 and to ISO 228-1