

RoHS ✓

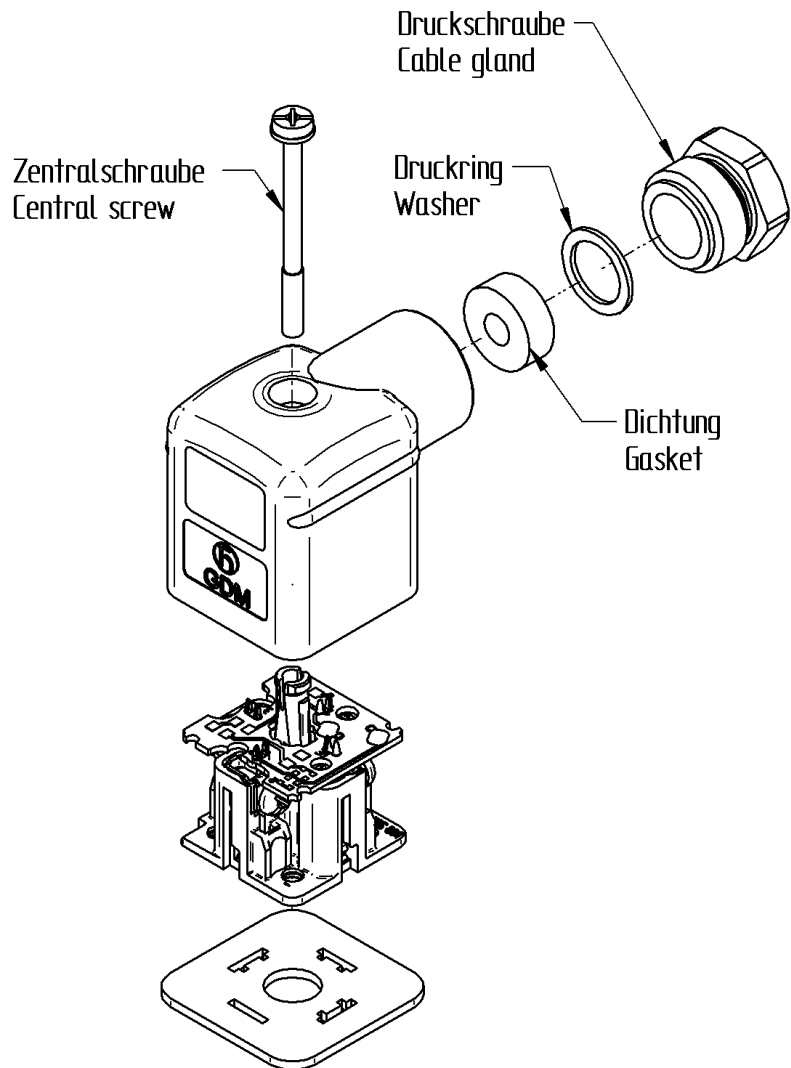

The information/details in this datasheet merely contain general descriptions or performance factors which, when applied in an actual situation, do not always correspond with the described form, and may be amended by way of the further development of products. The desired performance factors shall only be binding if these are expressly agreed on conclusion of the contract.

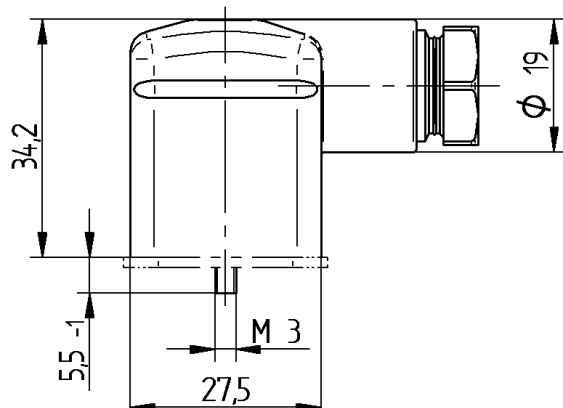
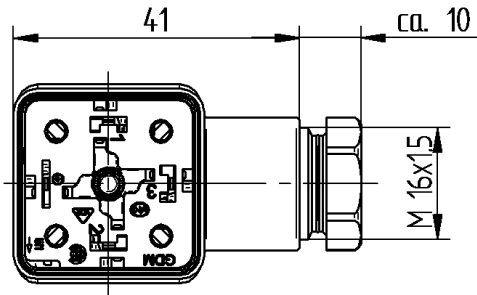

Product description

Description	Cable socket angled
Type	GDM ..., see standard products
Order No	934-888-..., see standard products
Type of contacts	female
Number of contacts	2+PE, 3+PE, see standard products
Cable gland	M16x1,5 *
Strain-relief	on request
Conductor size	0,25 mm ² - 1,5 mm ²
Standard	DIN EN 175301-803-A
Color housing	black or transparent **
Color contact bearer	black
Color cable gland	black, grey

* Cable gland: PG9, PG11 on request

** other colors on request

Description of wiring

Function indicator	optional, see circuits
Current consumption	< 20 mA, LED function indicator
Voltage rectifier	optional full bridge rectifier, see circuits.
Protective circuit	Overview voltage ranges: nominal voltage / max. voltage 12 V / 15 V 24 V / 30 V 48 V / 60 V 120 V / 150 V 230 V / 250 V

Overview nominal voltage and protective circuit

12 V	: Suppressordiode, Breakdownvoltage: 36 V
24 V	: Suppressordiode, Breakdownvoltage: 36 V
24 V	: Varistor, Varistor voltage: 47 V
48 V	: Varistor, Varistor voltage: 100 V
120 V	: Varistor, Varistor voltage: 240 V
230 V	: Varistor, Varistor voltage: 470 V
230 V	: recovery diode, app. 1,2 V

Circuits see last page

Technical data

Clearance / Creepage distance	DIN EN 60664-1 (2008/01); VDE 0110-1
Rated voltage	12 V AC/DC - 250 AC/DC
Rated current *	1 A - 10 A, see circuits 1 A, Bridge rectifier 10 A, LED function indicator
Rated impulse voltage	2,0 kV
Pollution degree	3 acc. to DIN EN 60664-1 (VDE 0110-1)
Contact resistance	≤ 10 mOhm
Type of connection	Screw terminal
Mating cycles	max. 50
Suitable cables	Ø4,5 mm to Ø10,0 mm**
Mounting	Central screw M 3x35

* Notice derating

** different cable diameter on request

Materials

Contact	CuZn
Contact plating	Cu/Sn
Contact bearer	PA 6 GF*
Housing	PA 6 GF*
Central screw	4.8 , Fe/Zn B **
Gasket(s)	NBR *, cable gland
Cable gland screw	PA 6 GF*

* standard material, other materials on request

** other materials see accessory

Environmental conditions

Protection class (IEC 60529) *	IP65**
Temperature range	-25°C to +90°C, notice Derating ***

* only if mounted and locked in combination with Hirschmann / Lumberg connector.

** Standard product IP65. IP67, IP68 on request

*** Temp.-range: -55°C to +90° depending on used materials.

Flammability class

Housing	UL 94 HB*
Contact bearer	UL 94 HB*
Cable gland screw	UL 94 HB*

* Standard: HB. Inflammability class: V0, 5VA on request

Approvals

VDE	VDE-Reg.-Nr.: E349
-----	--------------------

Accessories

Accessories to order separately

Gasket:

735-677-003, NBR, Temp. range: -25°C to +90°C, captive gasket GDMF-6 NBR, black

735-677-004, EPDM, Temp. range: -25°C to +120°C, captive gasket GDMF-6 EPDM, brown

730-801-002, NBR, Temp. range: -30°C to +90°C, flat gasket GDM 3-7, brown

731-739-004, EPDM, Temp. range: -40°C to +125°C, flat gasket GDM 3-21, brown

731-740-002, MPQ, Temp. range: -40°C to +125°C, flat gasket GDM 3-17, red

731-531-002, NBR, Temp. range: -30°C to +90°C, profiled gasket GDM 3-16, black

731-532-002, VMQ, Temp. range: -40°C to +125°C, profiled gasket GDM 3-19, red

735-823-002, EPDM Temp. range: -40°C to +125°C, profiled gasket GDM 3-24, brown

central screw:

732-383-003, steel screw, GDM 3011-6

732-488-002, knurled head (grey), GDM 3011-7

734-363-001, stainless steel screw, GDM 3011 RF-1

735-507-002, Torx screw, GDM 3011-18

Additional technical data

Fastening torque (central screw)

M 3: (50-60) Ncm

Fastening torque (cable gland)

M 16x1,5: (250-375) Ncm

Fastening torque (contact screw)

M 3: (40-50) Ncmfor Wiresize: 0,5 mm² bis 1,5 mm²

M 3: (30-40) Ncmfor Wiresize: 0,34 mm²

M 3: (25-30) Ncmfor Wiresize: 0,25 mm²

Cutline

Do not connect / disconnect under load.

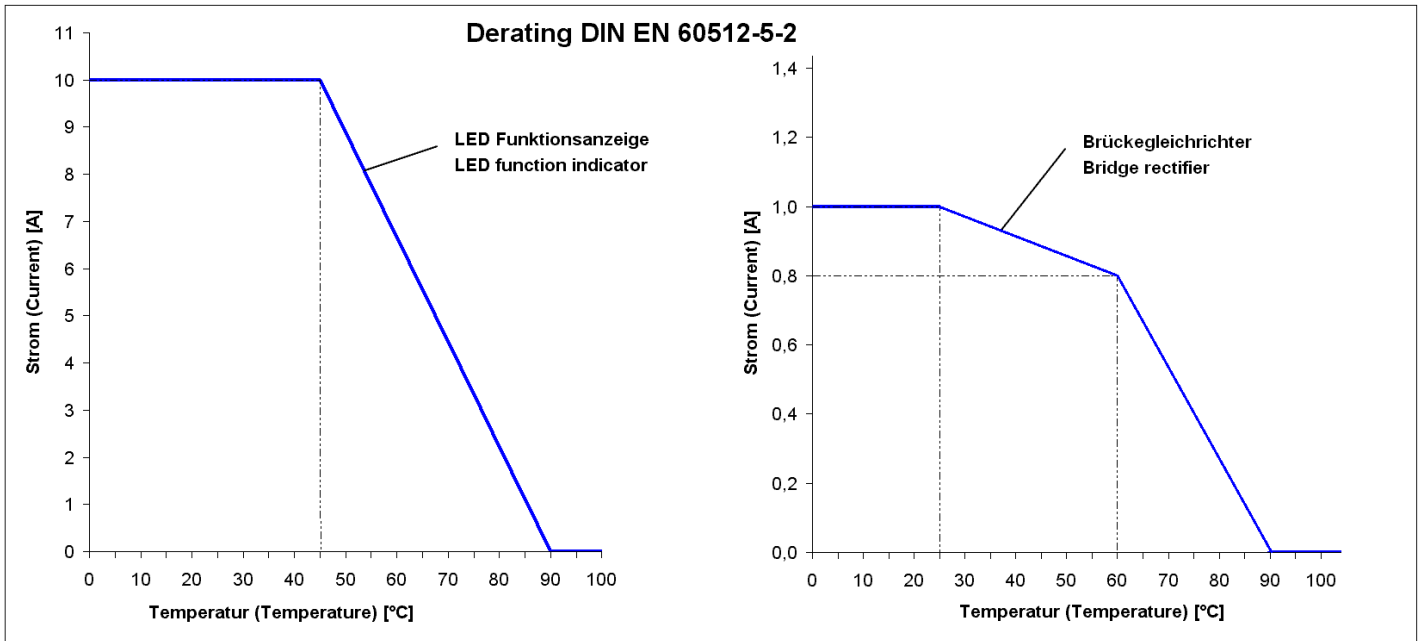

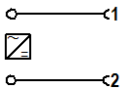
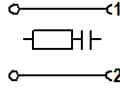
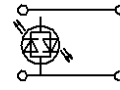
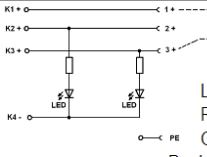
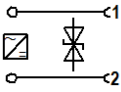
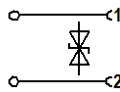
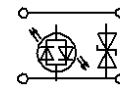
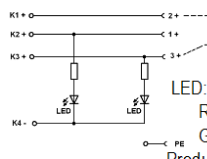
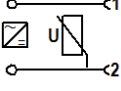
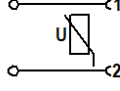
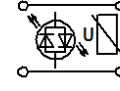
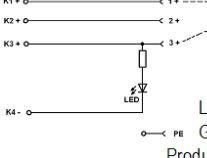
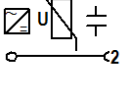
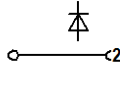
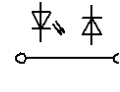
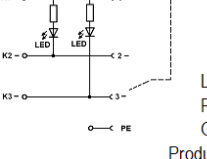
Brückgleichrichter * Bridge rectifier *	Schutzbeschaltungen protective circuit	Funktionsanzeige LED gelb function indicator LED yellow	Öffner / Schliesser pressure switch
ohne Schutzbeschaltung without protective circuit  Productcode: D3 with LED: D4	1A / 230V RC-Glied RC-element  Productcode: C1 with LED: C2	10A / 230V ohne Schutzbeschaltung without protective circuit  Productcode: L1	10A / 24V / 48V / 120V / 230V  LED: RD/GN or GN/YE Productcode: P1
mit Suppressordiode with suppressordiode  Productcode: S3 with LED: S4	1A / 24V Suppressordiode suppressordiode  Productcode: S1	10A / 24V mit Suppressordiode with suppressordiode  Productcode: S2	10A / 24V / 48V / 120V / 230V  LED: RD/GN or GN/YE Productcode: P2
mit Varistor with varistor  Productcode: V3 with LED: V4	1A / 24V / 48V / 120V / 230V Varistor varistor  Productcode: V1	10A / 24V / 48V / 120V / 230V mit Varistor with varistor  Productcode: V2	10A / 24V / 48V / 120V / 230V  LED: GN or YE Productcode: P3
mit Varistor und Kondensator with varistor and condensator  Productcode: C3 with LED: C4	1A / 230V Freilaufdiode recovery diode  Productcode: D1	10A / 230V mit Freilaufdiode with recovery diode  Productcode: D2	10A / 24V / 48V / 120V / 230V  LED: RD/GN or GN/YE Productcode: P4

* alle Brückgleichrichter optional mit Funktionsanzeige LED gelb
all bridge rectifiers optionally with function indicator LED yellow
LED-Farben: rot grün, blau auf Anfrage
LED-color: red, green, blue on request

Standard products

Artikel-No.	Type	Description of wiring	Protective circuit	Function indicator
934-888-005	GDM2106-C1U	C1:10A 230V, AC/DC	RC-Glied/RC-element	
934-888-006	GDM21F6-C2Y-10D	C2:10A 230V, AC/DC	RC-Glied/RC-element	LED: gelb / yellow
934-888-007	GDM2106-C3S-10D	C3:1A 120V, AC/DC	Varistor / Capacitor	
934-888-008	GDM2106-C3U-10D	C3:1A 230V, AC/DC	Varistor / Capacitor	
934-888-009	GDM21F6-C4Y-10D	C4:1A 230V, AC/DC	Varistor / Capacitor	LED: gelb / yellow
934-888-010	GDM2106-D1U-10D	D1:10A 230V, DC	Freilauf-/recoverydiode	
934-888-011	GDM21F6-D24-10D	D2:10A 24V, DC	Freilauf-/recoverydiode	LED: gelb / yellow
934-888-012	GDM21F6-D28-10D	D2:10A 48V, DC	Freilauf-/recoverydiode	LED: gelb / yellow
934-888-013	GDM2106-D3U-10D	D3:1A 230V, AC/DC	-	
934-888-014	GDM21F6-D44-10D	D4:1A 24V, AC/DC	-	LED: gelb / yellow
934-888-015	GDM21F6-D48-10D	D4:1A 48V, AC/DC	-	LED: gelb / yellow
934-888-016	GDM21F6-L12-10D	L1:10A 12V, AC/DC	-	LED: gelb / yellow
934-888-017	GDM21F6-L14-10D	L1:10A 24V, AC/DC	-	LED: gelb / yellow
934-888-018	GDM21F6-L18-10D	L1:10A 48V, AC/DC	-	LED: gelb / yellow
934-888-019	GDM21F6-L11-10D	L1:10A 120V, AC/DC	-	LED: gelb / yellow
934-888-020	GDM21F6-L1Y-10D	L1:10A 230V, AC/DC	-	LED: gelb / yellow
934-888-021	GDM31F6-P1J-10D	P1:10A 24V, DC	-	rot/grün / red/green
934-888-022	GDM31F6-P1N-10D	P1:10A 230V, DC	-	rot/grün / red/green
934-888-023	GDM31F6-P2J-10D	P2:10A 24V, DC	-	rot/grün / red/green
934-888-024	GDM31F6-P2N	P2:10A 230V, DC	-	rot/grün / red/green
934-888-025	GDM2106-S1Q-10D	S1:10A 24V, AC/DC	Suppressordiode	
934-888-026	GDM21F6-S22-10D	S2:10A 12V, AC/DC	Suppressordiode	LED: gelb / yellow
934-888-027	GDM21F6-S24-10D	S2:10A 24V, AC/DC	Suppressordiode	LED: gelb / yellow
934-888-028	GDM2106-S3Q-10D	S3:1A 24V, AC/DC	Suppressordiode	
934-888-029	GDM21F6-S44-10D	S4:1A 24V, AC/DC	Suppressordiode	LED: gelb / yellow
934-888-030	GDM21F6-S9Y	S9:10A 12V-230V AC/DC	-	LED: gelb / yellow
934-888-031	GDM2106-V1Q-10D	V1:10A 24V, AC/DC	Varistor	
934-888-032	GDM2106-V1S-10D	V1:10A 120V, AC/DC	Varistor	
934-888-033	GDM2106-V1U-10D	V1:10A 230V, AC/DC	Varistor	
934-888-034	GDM21F6-V24-10D	V2:10A 24V, AC/DC	Varistor	LED: gelb / yellow
934-888-035	GDM21F6-V21-10D	V2:10A 120V, AC/DC	Varistor	LED: gelb / yellow
934-888-036	GDM21F6-V2Y-10D	V2:10A 230V, AC/DC	Varistor	LED: gelb / yellow
934-888-037	GDM2106-V3S-10D	V3:1A 120V, AC/DC	Varistor	
934-888-038	GDM2106-V3U-10D	V3:1A 230V, AC/DC	Varistor	
934-888-039	GDM21F6-V44-10D	V4:1A 24V, AC/DC	Varistor	LED: gelb / yellow
934-888-040	GDM21F6-V48-10D	V4:1A 48V, AC/DC	Varistor	LED: gelb / yellow
934-888-084	GDM21L6-V24-10D	V2:10A 24V, AC/DC	Varistor	LED: gelb / yellow
934-888-137	GDM21F6-V28-10D	V2:10A 48V, AC/DC	Varistor	LED: gelb / yellow
934-888-162	GDM3106-D1U-10D	D1:10A 230V, DC	Freilauf-/recoverydiode	