

4W Constant Current LED Driver

IZC035-004F-4065C-SAL

Product Overview

The IZC035-004F-4065C-SAL is a low wattage Constant Current LED drivers, IP65 rated, small and compact design.



Key Features

- Super compact design
- Universal AC input
- Primary and secondary sides come with leads
- Open circuit, short circuit, overload and overheating protection
- Simple installation
- IP65

Applications

- LED signs
- LED strips and tapes
- Outdoor LED lighting
- Display cases
- LED downlights and office lighting
- Retail and entertainment lighting

IZC035-004F-4065C-SAL Specification

Input Voltage	100~ 240 VAC
Power Factor	0.4
Output Voltage	3 ~ 12V
Output Current	350mA
Power	4W
Ambient Temperature	-20°C ~ +50°C
Casing Temperature	85°C
Safety Standard	Design refers to EN61347-1, EN61347-2-13
EMC	Compliance to EN55015, EN61000-3-2, EN61000-3-2, EN61000-3-3, EN61547
Connections (input)	180mm 2C
Connections (output)	180mm 2C

Technical Drawing (mm)

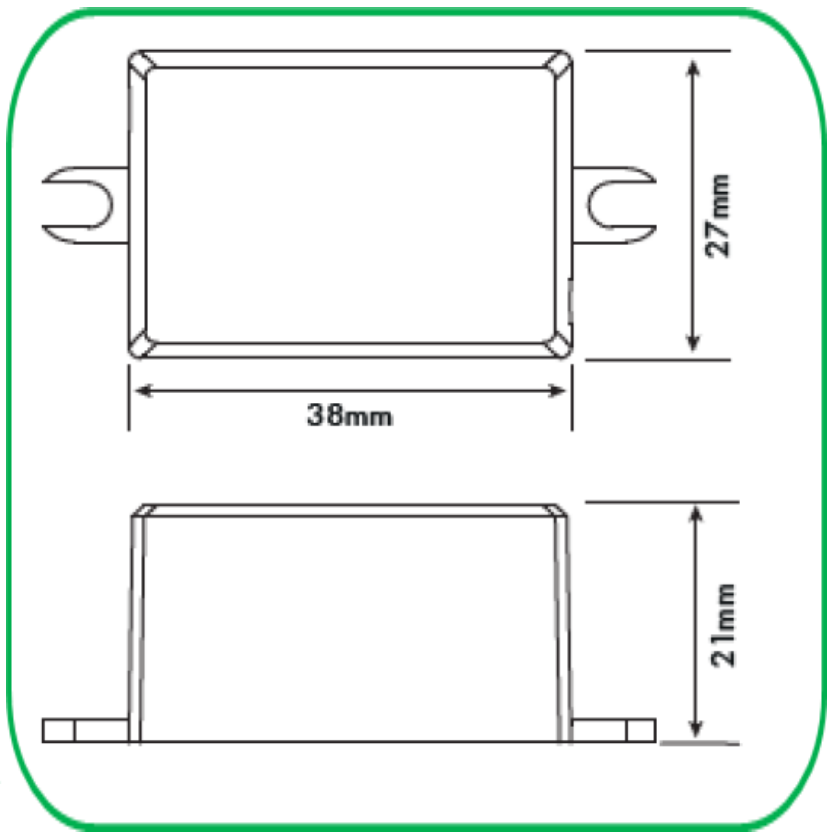

For further information please contact ILS

The values contained in this data sheet can change due to technical innovations. Any such changes will be made without separate notification.