

**Description:** Autotransformer Input: 230V Output: 80V/100V/125V/150V/170V/190V // 9.5A

Rev.	ST no.	Initials	Sign	Date	Appr.	Sign	Changes
<b>1</b>	<b>59351</b>	<b>AG</b>		<b>07.02.2018</b>	<b>JS</b>		Initial version

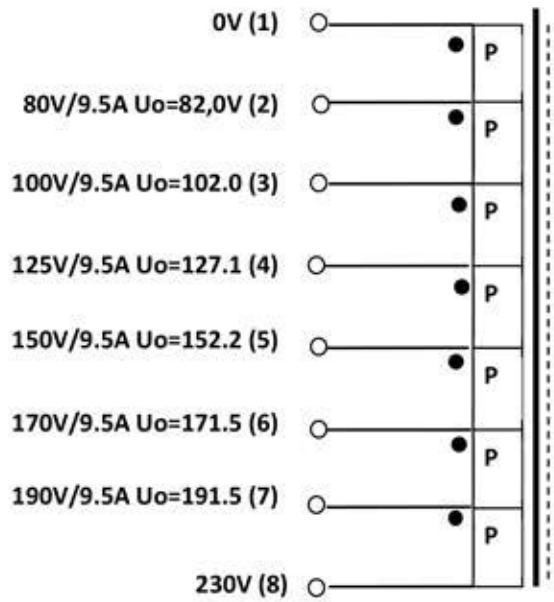

Temperature class: B

$T_a = 40^{\circ}\text{C}$

Description: Autotransformer Input: 230V Output: 80V/100V/125V/150V/170V/190V // 9.5A

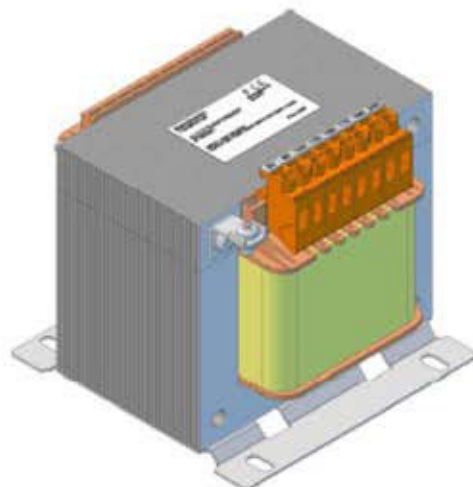
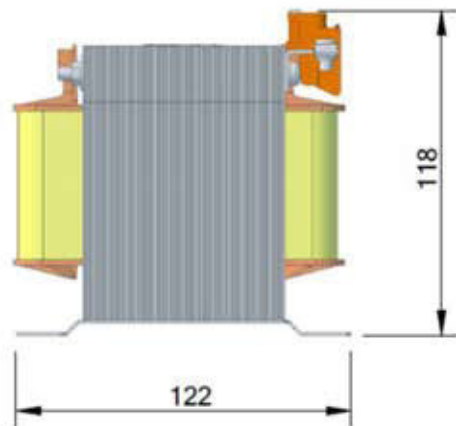
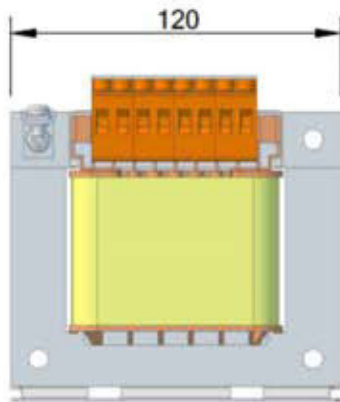
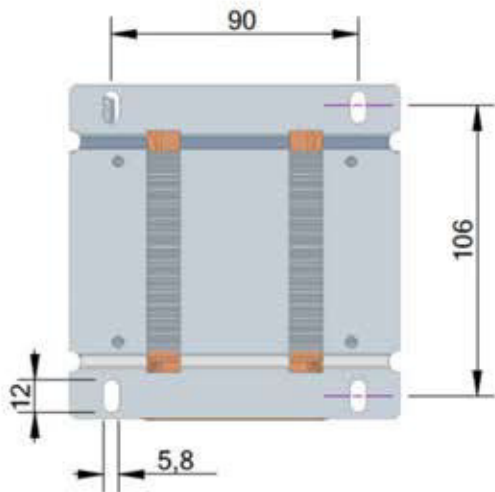

**Scandinavian  
Transformer**