



# Thyristor Module

$V_{RRM} = 1800\text{ V}$

$I_{TAV} = 560\text{ A}$

$V_T = 1.01\text{ V}$

## Single Thyristor

Part number

**MCO500-18io1**

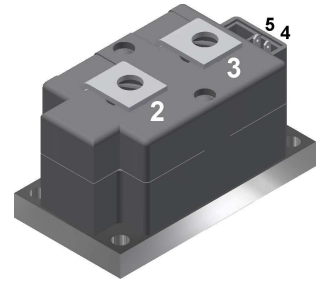

Backside: isolated



### Features / Advantages:

- Thyristor for line frequency
- Planar passivated chip
- Long-term stability
- Direct Copper Bonded Al<sub>2</sub>O<sub>3</sub>-ceramic

### Applications:

- Line rectifying 50/60 Hz
- Softstart AC motor control
- DC Motor control
- Power converter
- AC power control
- Lighting and temperature control

### Package: Y1

- Isolation Voltage: 3600 V~
- Industry standard outline
- RoHS compliant
- Soldering pins for PCB mounting
- Base plate: Copper internally DCB isolated
- Advanced power cycling

### Disclaimer Notice

Information furnished is believed to be accurate and reliable. However, users should independently evaluate the suitability of and test each product selected for their own applications. Littelfuse products are not designed for, and may not be used in, all applications. Read complete Disclaimer Notice at [www.littelfuse.com/disclaimer-electronics](http://www.littelfuse.com/disclaimer-electronics).

Thyristor			Ratings			
Symbol	Definition	Conditions	min.	typ.	max.	Unit
$V_{RSM/DSM}$	max. non-repetitive reverse/forward blocking voltage	$T_{VJ} = 25^{\circ}C$			1900	V
$V_{RRM/DRM}$	max. repetitive reverse/forward blocking voltage	$T_{VJ} = 25^{\circ}C$			1800	V
$I_{RD}$	reverse current, drain current	$V_{R/D} = 1800 V$	$T_{VJ} = 25^{\circ}C$		2	mA
		$V_{R/D} = 1800 V$	$T_{VJ} = 125^{\circ}C$		40	mA
$V_T$	forward voltage drop	$I_T = 500 A$	$T_{VJ} = 25^{\circ}C$		1.08	V
		$I_T = 1000 A$			1.27	V
		$I_T = 500 A$	$T_{VJ} = 125^{\circ}C$		1.01	V
		$I_T = 1000 A$			1.24	V
$I_{TAV}$	average forward current	$T_C = 85^{\circ}C$	$T_{VJ} = 140^{\circ}C$		560	A
$I_{T(RMS)}$	RMS forward current	180° sine			880	A
$V_{T0}$	threshold voltage	} for power loss calculation only	$T_{VJ} = 140^{\circ}C$		0.80	V
$r_T$	slope resistance				0.38	mΩ
$R_{thJC}$	thermal resistance junction to case				0.072	K/W
$R_{thCH}$	thermal resistance case to heatsink			0.024		K/W
$P_{tot}$	total power dissipation		$T_C = 25^{\circ}C$		1600	W
$I_{TSM}$	max. forward surge current	$t = 10 \text{ ms}; (50 \text{ Hz}), \text{ sine}$	$T_{VJ} = 45^{\circ}C$		17.0	kA
		$t = 8,3 \text{ ms}; (60 \text{ Hz}), \text{ sine}$	$V_R = 0 V$		18.4	kA
		$t = 10 \text{ ms}; (50 \text{ Hz}), \text{ sine}$	$T_{VJ} = 140^{\circ}C$		14.5	kA
		$t = 8,3 \text{ ms}; (60 \text{ Hz}), \text{ sine}$	$V_R = 0 V$		15.6	kA
$I^2t$	value for fusing	$t = 10 \text{ ms}; (50 \text{ Hz}), \text{ sine}$	$T_{VJ} = 45^{\circ}C$		1.45	MA <sup>2</sup> s
		$t = 8,3 \text{ ms}; (60 \text{ Hz}), \text{ sine}$	$V_R = 0 V$		1.40	MA <sup>2</sup> s
		$t = 10 \text{ ms}; (50 \text{ Hz}), \text{ sine}$	$T_{VJ} = 140^{\circ}C$		1.04	MA <sup>2</sup> s
		$t = 8,3 \text{ ms}; (60 \text{ Hz}), \text{ sine}$	$V_R = 0 V$		1.01	MA <sup>2</sup> s
$C_J$	junction capacitance	$V_R = 400 V \quad f = 1 \text{ MHz}$	$T_{VJ} = 25^{\circ}C$		876	pF
$P_{GM}$	max. gate power dissipation	$t_p = 30 \mu s$	$T_C = 140^{\circ}C$		120	W
		$t_p = 300 \mu s$			60	W
$P_{GAV}$	average gate power dissipation				20	W
$(di/dt)_{cr}$	critical rate of rise of current	$T_{VJ} = 140^{\circ}C; f = 50 \text{ Hz}$	repetitive, $I_T = 1500 A$		100	A/μs
		$t_p = 200 \mu s; di_G/dt = 1 A/\mu s;$	non-repet., $I_T = 500 A$		500	A/μs
$(dv/dt)_{cr}$	critical rate of rise of voltage	$V = \frac{2}{3} V_{DRM}$	$T_{VJ} = 140^{\circ}C$		1000	V/μs
		$R_{GK} = \infty; \text{method 1 (linear voltage rise)}$				
$V_{GT}$	gate trigger voltage	$V_D = 6 V$	$T_{VJ} = 25^{\circ}C$		2	V
			$T_{VJ} = -40^{\circ}C$		3	V
$I_{GT}$	gate trigger current	$V_D = 6 V$	$T_{VJ} = 25^{\circ}C$		300	mA
			$T_{VJ} = -40^{\circ}C$		400	mA
$V_{GD}$	gate non-trigger voltage	$V_D = \frac{2}{3} V_{DRM}$	$T_{VJ} = 140^{\circ}C$		0.25	V
$I_{GD}$	gate non-trigger current				10	mA
$I_L$	latching current	$t_p = 30 \mu s$	$T_{VJ} = 25^{\circ}C$		400	mA
		$I_G = 1 A; di_G/dt = 1 A/\mu s$				
$I_H$	holding current	$V_D = 6 V \quad R_{GK} = \infty$	$T_{VJ} = 25^{\circ}C$		300	mA
$t_{gd}$	gate controlled delay time	$V_D = \frac{1}{2} V_{DRM}$	$T_{VJ} = 25^{\circ}C$		2	μs
		$I_G = 1 A; di_G/dt = 1 A/\mu s$				
$t_q$	turn-off time	$V_R = 100 V; I_T = 500 A; V = \frac{2}{3} V_{DRM}$	$T_{VJ} = 125^{\circ}C$		350	μs
		$di/dt = 10 A/\mu s \quad dv/dt = 50 V/\mu s \quad t_p = 200 \mu s$				



Package Y1			Ratings			
Symbol	Definition	Conditions	min.	typ.	max.	Unit
$I_{RMS}$	RMS current	per terminal			600	A
$T_{VJ}$	virtual junction temperature		-40		140	°C
$T_{op}$	operation temperature		-40		125	°C
$T_{stg}$	storage temperature		-40		125	°C
<b>Weight</b>				650		g
$M_D$	mounting torque		4.5		7	Nm
$M_T$	terminal torque		11		13	Nm
$d_{Spp/App}$	creepage distance on surface   striking distance through air	terminal to terminal	16.0			mm
$d_{Spb/Apb}$		terminal to backside	25.0			mm
$V_{ISOL}$	isolation voltage	t = 1 second	3600			V
		t = 1 minute	3000			V

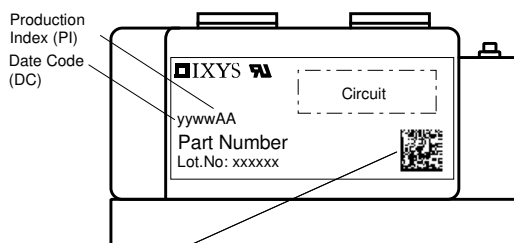

Data Matrix: part no. (1-19), DC + PI (20-25), lot.no.# (26-31), blank (32), serial no.# (33-36)

Ordering	Ordering Number	Marking on Product	Delivery Mode	Quantity	Code No.
Standard	MCO500-18io1	MCO500-18io1	Box	2	466433

Similar Part	Package	Voltage class
MCO500-12io1	Y1-2-CU	1200
MCO500-14io1	Y1-2-CU	1400
MCO500-16io1	Y1-2-CU	1600
MCO600-20io1	Y1-2-CU	2000

MCO600-22io1	Y1-2-CU	2200
--------------	---------	------

**Equivalent Circuits for Simulation**

\* on die level

$T_{VJ} = 140^{\circ}C$

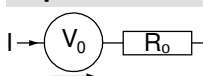

Thyristor

$V_{0\ max}$	threshold voltage	0.8	V
$R_{0\ max}$	slope resistance *	0.22	mΩ

**Outlines Y1**

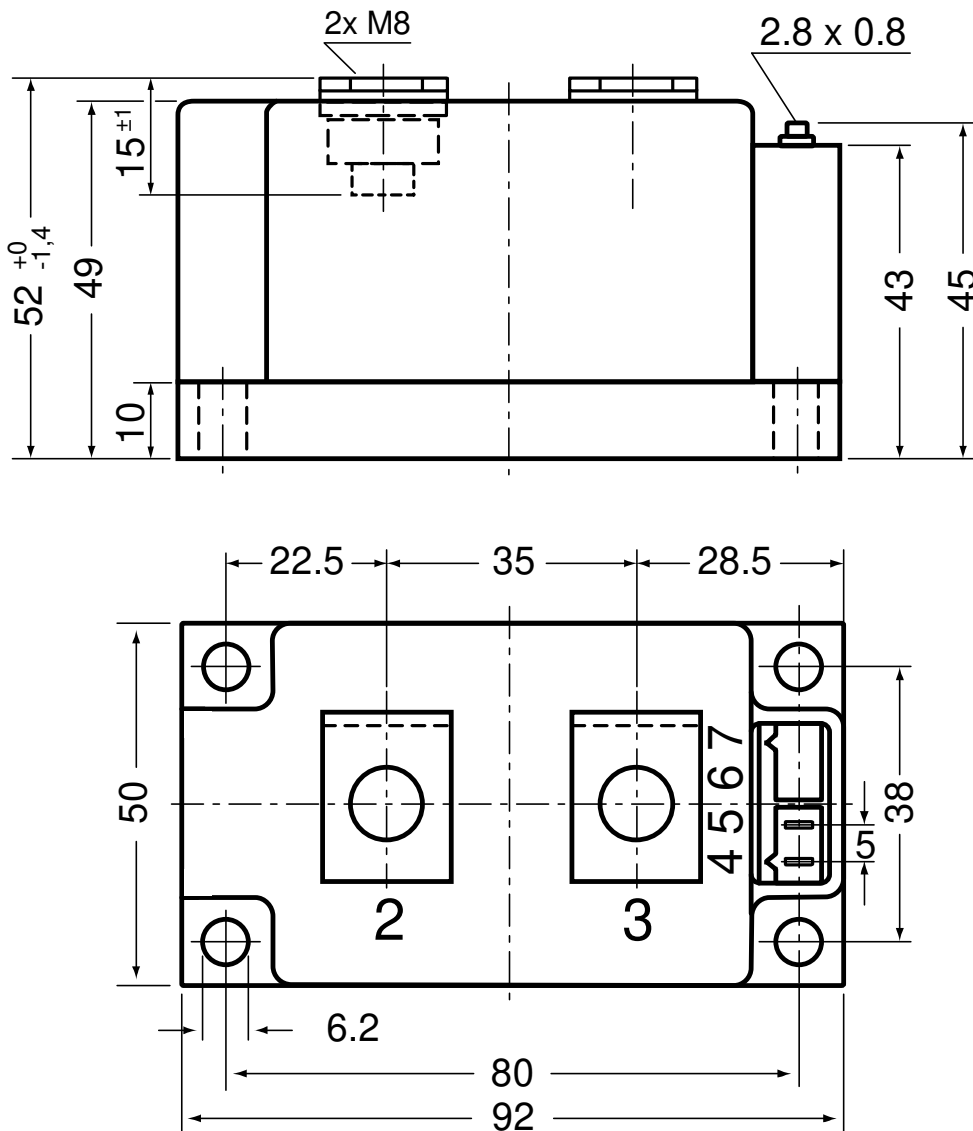

**Optional accessories for modules**

Keyed gate/cathode twin plugs with wire length = 350 mm, gate = white, cathode = red  
Type ZY 180L (L = Left for pin pair 4/5) UL 758, style 3751

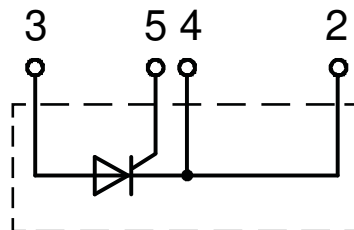

**Thyristor**

Fig. 1 Surge overload current  
 $I_{TSM}$ : Crest value,  $t$ : duration



Fig. 2  $I^2t$  versus time (1-10 ms)

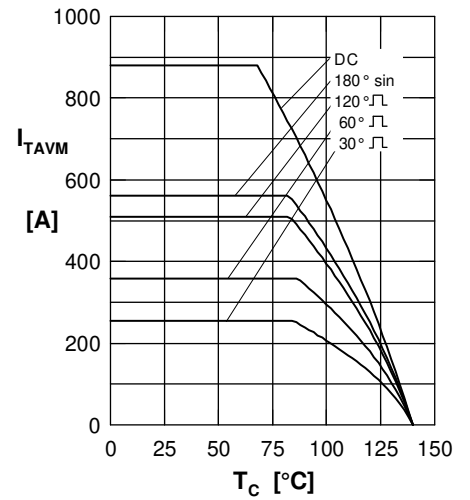

Fig. 3 Maximum forward current at case temperature



Fig. 4 Power dissipation versus on-state current & ambient temperature

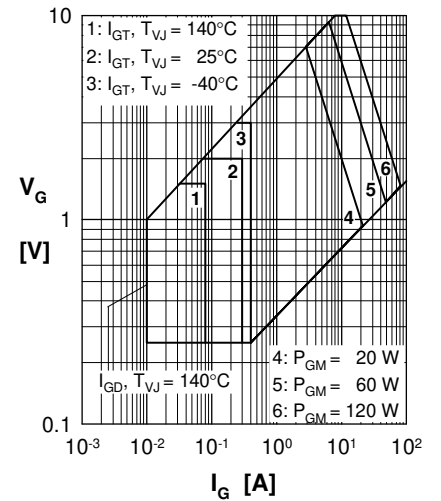

Fig. 5 Gate trigger characteristics

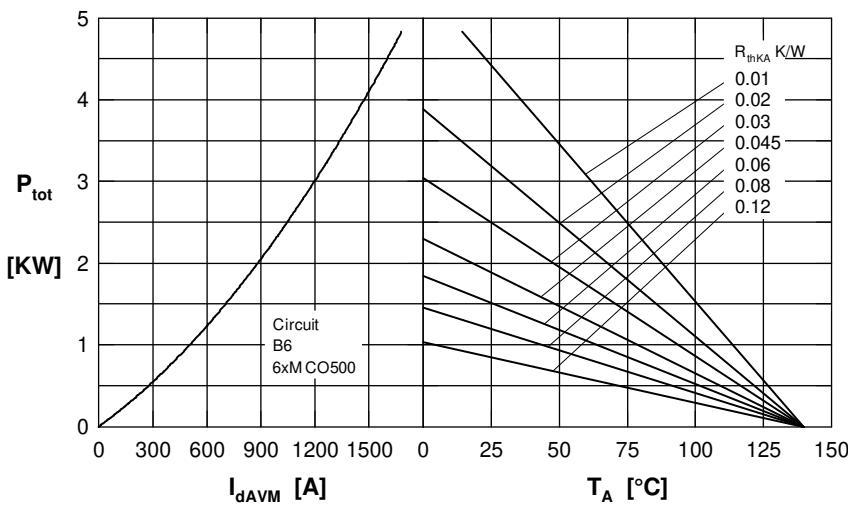

Fig. 6 Three phase rectifier bridge: Power dissipation versus direct output current and ambient temperature

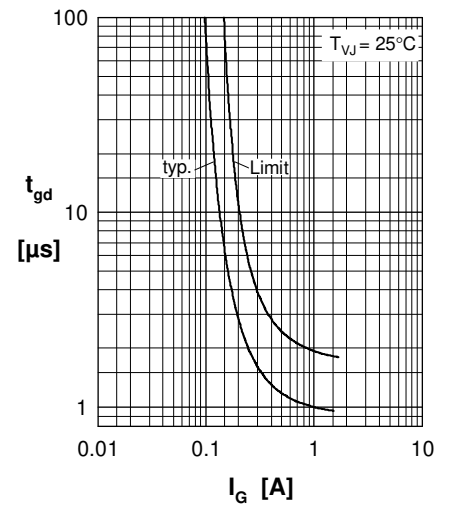

Fig. 7 Gate trigger delay time



**Thyristor**

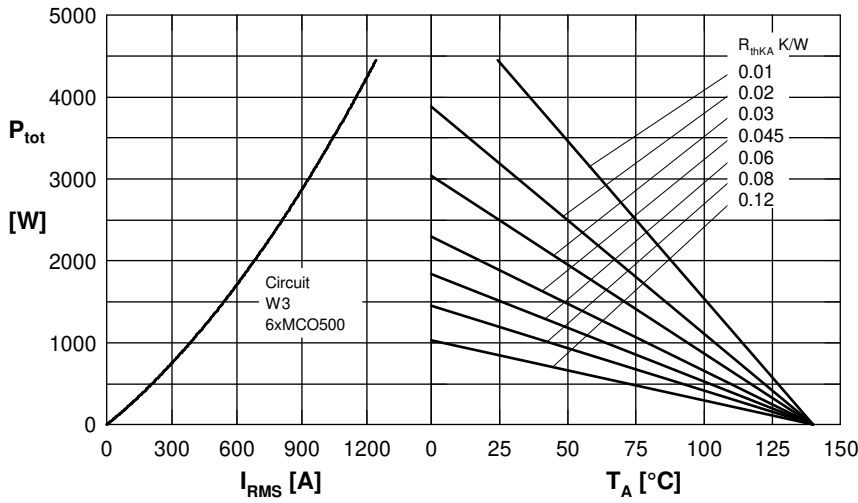

Fig. 8 Three phase AC-controller: Power dissipation versus RMS output current and ambient temperature

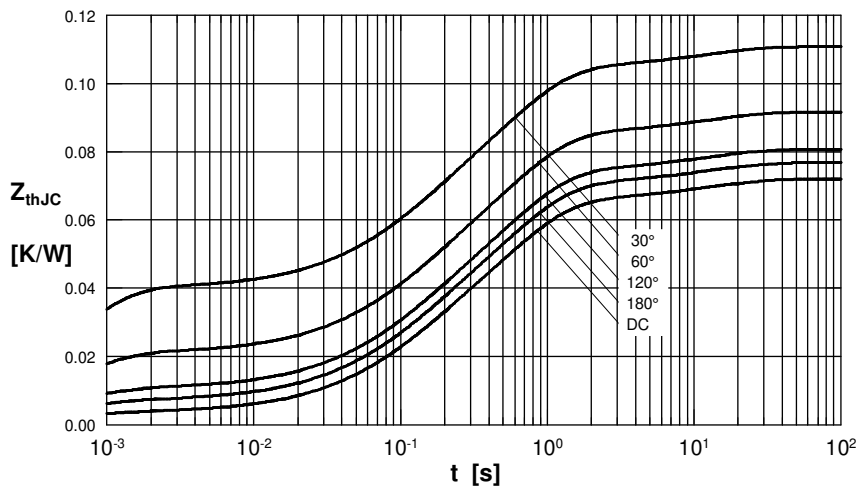

Fig. 9 Transient thermal impedance junction to case

$R_{thJC}$  for various conduction angles d:

d	$R_{thJC}$ (K/W)
DC	0.072
180°	0.0768
120°	0.081
60°	0.092
30°	0.111

Constants for  $Z_{thJC}$  calculation:

i	$R_{thi}$ (K/W)	$t_i$ (s)
1	0.0035	0.0054
2	0.0186	0.098
3	0.0432	0.54
4	0.0067	12

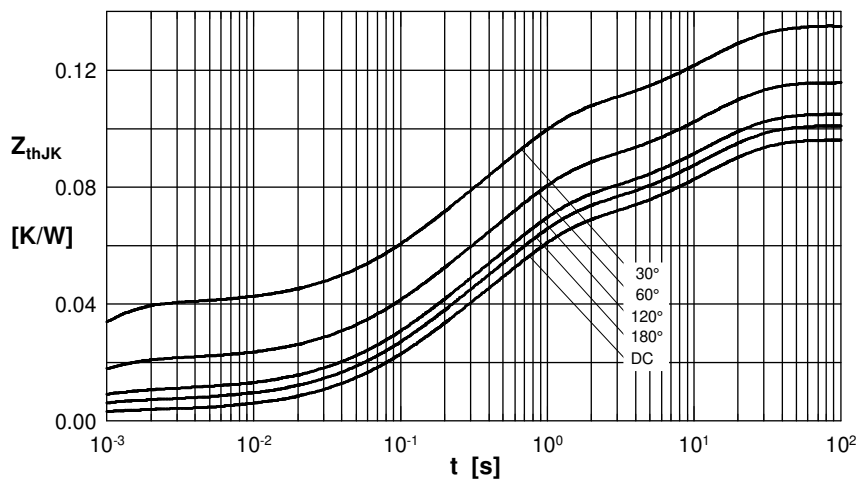

Fig.10 Transient thermal impedance junction to heatsink

$R_{thJK}$  for various conduction angles d:

d	$R_{thJK}$ (K/W)
DC	0.096
180°	0.1
120°	0.105
60°	0.116
30°	0.135

Constants for  $Z_{thJK}$  calculation:

i	$R_{thi}$ (K/W)	$t_i$ (s)
1	0.0035	0.0054
2	0.0186	0.098
3	0.0432	0.54
4	0.0067	12
5	0.024	12