

Data Sheet | Item Number: 221-682

COMPACT Splicing Connector; for all conductor types; for Ex e applications; max. 6 mm²; 2-conductor; with levers; transparent housing; Operating temperature (max.): 105 °C; 6,00 mm²; transparent

<https://www.wago.com/221-682>



Color: transparent

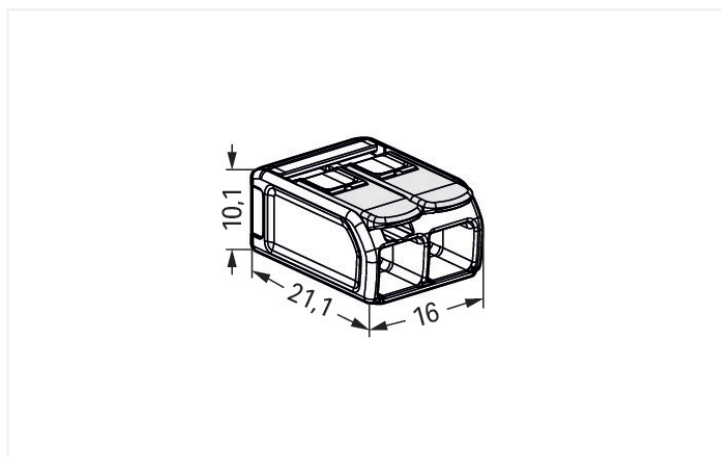
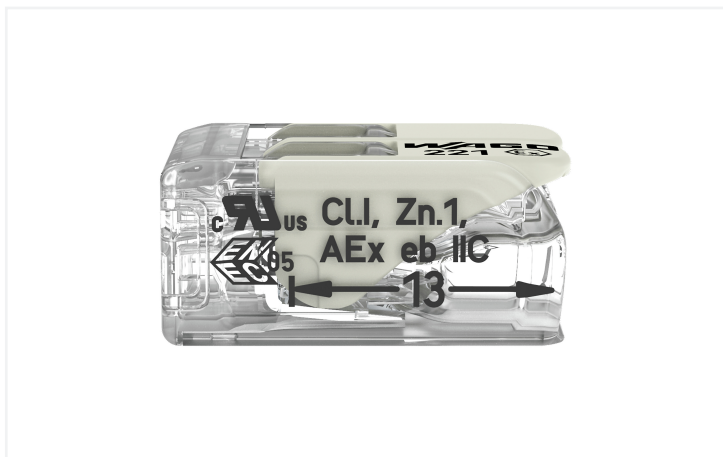

Dimensions in mm

Your benefits:

- Ease of use – pull the lever up, insert a conductor and push the lever back down
- Available as 2-, 3- and 5-wire connectors
- Easily terminate conductors from 0.5 to 6 mm²
- Connection of all conductor types
- Time savings for installers and device manufacturers
- Quickly install devices with higher power consumption
- Safely install long cable runs with larger conductor cross sections
- Mounting carrier for installation conforms to standards
- Working voltages of 275 V or 440 V
- Custom carriers are possible
- ATEX (Ex 2 II G), IECEx (Ex eb IIC Gb) Zone 1, 2
- IECEX (Ex eb IIC Gb), American Ex (AEx eb IICGb) / Class 1, Zone 1

Notes

Safety information

The permissible operating voltage of the connector with carrier (440 V or 275 V) depends on the mounting type.

Safety information 2

Only approved in conjunction with a mounting carrier (221-511). Other carriers are possible, see certificate/file.

The connectors must be installed in an enclosure meeting the requirements of a recognized protection type per EN 60079-0, Section 1 or EN 60079-31.

When installing the connectors in an enclosure of protection type "eb" (increased safety) per EN 60079-7, the clearances and creepage distances of Table 2 for this standard must be observed. See point 1 for the use of accessories. The connectors can be used both in Group II and Group I, as the standard requirements are identical in this case.

The use of these components requires a new assessment by a notified certification agency.

Electrical data

Ratings per	IEC/EN 60079-7		
Overtoltage category	III	III	II
Pollution degree	3	2	2
Nominal voltage	-	-	-
Rated surge voltage	-	-	-
Rated current	-	-	-

Approvals per	UL 60079		
Use group	B	C	D
Rated voltage	-	440 V	-
Rated current	-	30 A	-

Ex information

Ratings per	ATEX: PTB 19 ATEX 1001 U / IECEx: PTB 19.001 1U (Ex eb IIC Gb)
Rated voltage EN (Ex e II)	440 V
Rated current (Ex e II)	37 A

Connection data

Connection points	2
Total number of potentials	1

Connection 1

Connection technology	CAGE CLAMP®
Actuation type	Lever
Connectable conductor materials	Copper
Nominal cross-section	6 mm ² / 10 AWG
Solid conductor	0.5 ... 6 mm ² / 20 ... 10 AWG
Stranded conductor	0.5 ... 6 mm ² / 20 ... 10 AWG
Fine-stranded conductor	0.5 ... 6 mm ² / 20 ... 10 AWG
Strip length	12 ... 14 mm / 0.47 ... 0.55 inches
Wiring direction	Side-entry wiring

Physical data

Width	16 mm / 0.63 inches
Height	10.1 mm / 0.398 inches
Depth	21.1 mm / 0.831 inches

Material data

Note (material data)	Information on material specifications can be found here
Color	transparent
Material group	IIIa
Insulation material	Polycarbonate (PC)
Flammability class per UL94	V2
Fire load	0.066 MJ
Actuator color	light gray
Weight	3 g

Environmental requirements

Ambient temperature (storage)	-40 ... +60 °C
Continuous operating temperature	-55 ... +105 °C

Commercial data

ETIM 8.0	EC000446
ETIM 7.0	EC000446
PU (SPU)	500 (50) pcs
Packaging type	Box
Country of origin	CH
GTIN	4055143860390
Customs tariff number	85369010000

Environmental Product Compliance

RoHS Compliance Status	Compliant, No Exemption
------------------------	-------------------------

Approvals / Certificates

General approvals



Approval	Standard	Certificate Name
CB DEKRA Certification B.V.	IEC 60998	NL-81003
ENEC 05 DEKRA Certification B.V.	EN 60998	71-123784
UL Underwriters Laboratories Inc.	UL 486C	E69654

Declarations of conformity and manufacturer's declarations

Approval	Standard	Certificate Name
ATEX-Attestation of Conformity WAGO GmbH & Co. KG	-	-
EU-Declaration of Conformity WAGO GmbH & Co. KG	-	-
UK-Declaration of Conformity WAGO GmbH & Co. KG	-	-

Approvals for marine applications



Approval	Standard	Certificate Name
LR Lloyds Register	EN 60998	LR22207029TA

Approvals for hazardous areas



Approval	Standard	Certificate Name
AEx Underwriters Laboratories Inc.	UL 60079	E185892 (AEx eb IIC resp. Ex eb IIC)
CCC CNEX	GB/T 3836.3	2020312313000185 (Ex eb IIC Gb, Ex eb I Mb)
IECEX Physikalisch Technische Bundesanstalt	IEC 60079-0	IECEX PTB 19.001 1U (EX eb IIC Gb, Ex eb I Mb)
INMETRO TÜV Rheinland do Brasil Ltda.	IEC 60079	TÜV 19.1781 U

Downloads

Documentation

Bid Text
ausschreiben.de 221-682

CAD/CAE-Data

CAD data
2D/3D Models 221-682

CAE data
EPLAN Data Portal 221-682
ZUKEN Portal 221-682

1 Compatible Products

1.1 Optional Accessories

1.1.1 Mounting adapter

1.1.1.1 Mounting accessories



Item No.: 221-510/000-006
Mounting carrier; 221 Series - 6 mm²; for
DIN-35 rail mounting/screw mounting;
blue

Item No.: 221-511
Mounting carrier; for Ex applications; 221
Series - 6 mm²; for DIN-35 rail mounting/
screw mounting; light gray

Installation Notes

Conductor termination

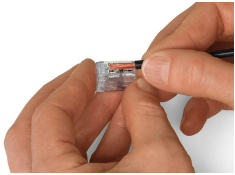

Strip conductor to 11 mm (0.43 inch).

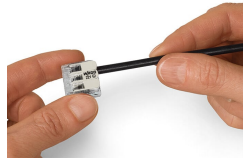

Then, lower the lever to close the clamp.

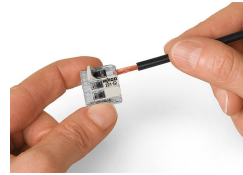

Termination: Lift the lever to open the clamping unit and insert a stripped conductor.

Installation

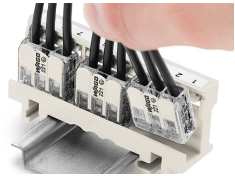

Inserting a connector into the mounting carrier.

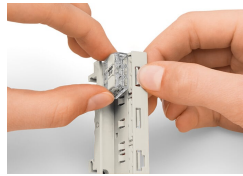

Removing a connector from the mounting carrier.

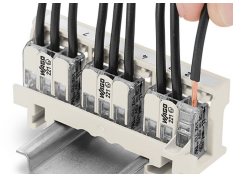

Removing a conductor.

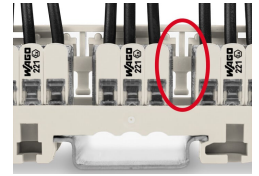

Mounting type (440 V)
Using spacers between the connectors.



Mounting type (440 V)
Vertical mounting on DIN-35 rail

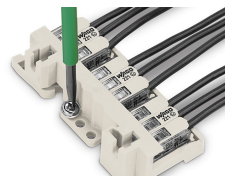

Mounting type (440 V)
Horizontal screw mounting on a flat surface



Mounting type (440 V)
Mounting the carrier via non-conductive screws.

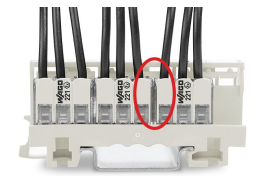

Mounting type (275 V)
No spacers are used between the connectors.



Mounting type (275 V)
Mounting the carrier using conductive screws.

Testing

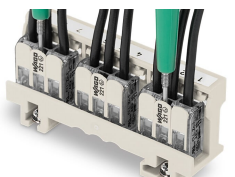

Easily test inserted connectors in the carrier - however they are mounted.