

Detailed technical data

Features

Medium	Liquid, gaseous
Measuring ranges	
Gauge pressure	0 bar ... 1 bar up to 0 bar ... 600 bar
Absolute pressure	0 bar ... 1 bar up to 0 bar ... 25 bar
Compound pressure	-1 bar ... 0 bar up to -1 bar ... +24 bar
Pressure units	Bar, MPa, psi and kg/cm ²
Process temperature	-20 °C ... +85 °C
Analog signal output and ohmic load R_A	4 mA ... 20 mA (R _A ≤ 0.5 kOhm) 0 V ... 10 V, 3-wire (R _A > 10 kOhm)
Zero point adjustment	Max. + 3 % of span
Switching output	Transistor switching output PNP or NPN Number: 1 or 2 (with IO-Link: C/Q ₁ : PNP) Function: normally open/normally closed, windows- and hysteresis function freely adjustable Contact rating: Supply voltage L ⁺ - 1 V [V DC] Max. switching current: 250 mA, with IO-Link: C/Q ₁ : 100 mA, Q ₂ : 250 mA Switching delay: 0 s ... 50 s (adjustable) Response time: ≤ 10 ms Individually adjustable via external control buttons Setting accuracy: ≤ 0.5 % of span
Rotatable housing	Display against housing with electrical connection: 330 ° Housing against process connection: 320 °
Display	14-segment-LED, blue, 4-digits, height 9 mm, electronically turnable by 180° Accuracy: ≤ 1 % of span ± 1 digit Update: 1,000, 500, 200, 100 ms (adjustable)

Performance

Non-linearity	≤ ± 0.5 %, of span (Best Fit Straight Line, BFSL) according to IEC 61298-2
Accuracy	≤ ± 1 % of the span Including non-linearity, hysteresis, zero point and full scale error (corresponds to error of measurement as per IEC 61298-2)
Response time	3 ms
Long-term drift/one-year stability	≤ 0.2 % of the span according to IEC 61298-2
Temperature error	≤ 1.0 % of span typ., ≤ 2.5 % of span max.
Temperature coefficient in rated temperature range	Mean TC of zero point: ≤ 0.2% of span / 10 K Mean TC of span ≤ 0.2 % of span / 10 K
Rated temperature range	0 °C ... +80 °C
Service life	Minimum 100 Mio. life cycles

Mechanics/electronics

Process connection	See type code
Wetted parts	Pressure connection: stainless steel 316L Pressure sensor: stainless steel 316L (for measurement ranges from 0 bar ... 10 bar rel stainless steel 13-8 PH)
Internal transmission fluid	Silicone oil (only with pressure ranges < 0 bar ... 10 bar and ≤ 0 bar abs ... 25 bar abs)
Pressure peak dampening ¹⁾	Through integrated pressure port 0.6 mm or 0.3 mm for process connection G ¼ according to DIN 3852-E (0.3 mm at and above 10 bar)

¹⁾ Available upon request for process connections G ¼ A according to DIN 3852-E, ¼ " NPT, R ¼ according to ISO 7, and 7/16"-20 UNF.

²⁾ Enclosure rating IP per IEC 60529. The enclosure rating classes specified only apply when connected with female connectors that provide the corresponding enclosure rating.

Pressure port	3.5 mm (standard) 0.3 mm (pressure port) 0.6 mm (pressure port) Flush-mounted membrane
Housing material	Lower body: stainless steel 304, Plastic head: PC + ABS, Buttons: TPE-E, Display window: PC
Electrical connection/enclosure rating	Round connector M12 x 1, 4-pin with 2 switching outputs or with 1 switching output + analog output, IP65/67 ²⁾ Round connector M12 x 1, 5-pin with 2 switching outputs + analog output,, IP65/67
Supply voltage	15 V DC ... 35 V DC
Power consumption	45 mA (for configurations without analog output signal) 70 mA (for configurations with analog output signal)
Total current consumption	Max. 350 mA / 570 mA (incl. switching current)
Electrical safety	Protection class: III Overvoltage protection: 40 V DC Short-circuit protection: Q _A , Q ₁ , Q ₂ towards M Reverse polarity protection: L ⁺ to M
Insulation voltage	500 V DC
CE-conformity	Pressure equipment directive: This instrument is a pressure accessory as defined by the directive 97/23/EC, EMC directive: 2004/108/EC, EN 61326-2-3
Weight sensor	Approx. 200 g
Seal	NBR FKM/FPM Copper Stainless steel Without seal

¹⁾ Available upon request for process connections G 1/4 A according to DIN 3852-E, 1/4 " NPT, R 1/4 according to ISO 7, and 7/16"-20 UNF.

²⁾ Enclosure rating IP per IEC 60529. The enclosure rating classes specified only apply when connected with female connectors that provide the corresponding enclosure rating.

Ambient data

Ambient temperature	-20 °C ... +80 °C
Storage temperature	-20 °C ... +80 °C
Relative humidity	≤ 90 %
Shock load	50 g according to IEC 60068-2-27 (mechanical shock)
Vibration load	10 g according to IEC 60068-2-6 (vibration under resonance)

	Gauge Pressure	Overpressure safety
016	0 ... 16 bar	32 bar
025	0 ... 25 bar	50 bar
040	0 ... 40 bar	80 bar
060	0 ... 60 bar	120 bar
100	0 ... 100 bar	200 bar
160	0 ... 160 bar	320 bar
250	0 ... 250 bar	500 bar
400	0 ... 400 bar	800 bar
600	0 ... 600 bar	1200 bar

	Absolute Pressure	Overpressure safety
016	0 ... 16 bar abs	32 bar abs
025	0 ... 25 bar abs	50 bar abs

	Compound Pressure	Overpressure safety
025	-1 ... +24 bar	48 bar

	Gauge Pressure	Overpressure safety
015	0 ... 15 psi	30 psi
025	0 ... 25 psi	60 psi
030	0 ... 30 psi	60 psi
050	0 ... 50 psi	100 psi
100	0 ... 100 psi	200 psi
160	0 ... 160 psi	320 psi
200	0 ... 200 psi	400 psi
300	0 ... 300 psi	600 psi
500	0 ... 500 psi	1000 psi
1K0	0 ... 1000 psi	2000 psi
1K5	0 ... 1500 psi	3000 psi
2K0	0 ... 2000 psi	4000 psi
3K0	0 ... 3000 psi	6000 psi
5K0	0 ... 5000 psi	10000 psi
8K0	0 ... 8000 psi	16000 psi

	Absolute Pressure	Overpressure safety
015	0 ... 15 psi abs	30 psi abs
025	0 ... 25 psi abs	60 psi abs
030	0 ... 30 psi abs	60 psi abs
050	0 ... 50 psi abs	100 psi abs
100	0 ... 100 psi abs	200 psi abs
160	0 ... 160 psi abs	290 psi abs
200	0 ... 200 psi abs	400 psi abs
300	0 ... 300 psi abs	600 psi abs

	Compound Pressure	Overpressure safety
015	-14,5 ... +0 psi	30 psi
030	-14,5 ... +15 psi	30 psi
040	-14,5 ... +25 psi	60 psi
045	-14,5 ... +30 psi	60 psi
065	-14,5 ... +50 psi	100 psi
115	-14,5 ... +100 psi	200 psi
175	-14,5 ... +160 psi	320 psi
215	-14,5 ... +200 psi	400 psi
315	-14,5 ... +300 psi	600 psi

Ordering information

The part numbers below show a selection of our common configurations and represent only a portion of the product portfolio. The type code on page 5 indicates possible configurations that can be ordered.

PBS-AB

- Absolute pressure
- **Process connection:** G ¼ A according to DIN 3852-E
- **Seal:** NBR
- **Process temperature:** -20 °C ... +85 °C
- **Accuracy:** ≤ ± 1 % of the span
- **Pressure port:** Standard

Output signal	Electrical connection	Measuring range	Type	Part no.
IO-Link/PNP + PNP + 4 mA ... 20 mA	Round connector M12 x 1, 5-pin, IP67	0 bar ... 10 bar	PBS-AB010SG1SSNQ5A0Z	6042917
2 x PNP	Round connector M12 x 1, 4-pin, IP67	0 bar ... 16 bar	PBS-AB016SG1SSNAMA0Z	6039775
		0 bar ... 10 bar	PBS-AB010SG1SSNAMA0Z	6048436
		0 bar ... 2.5 bar	PBS-AB2X5SG1SSNAMA0Z	6045253
		0 bar ... 1.6 bar	PBS-AB1X6SG1SSNAMA0Z	6039652
		0 bar ... 1 bar	PBS-AB1X0SG1SSNAMA0Z	6049474

PBS-CB

- Compound pressure
- **Process temperature:** -20 °C ... +85 °C
- **Accuracy:** ≤ ± 1 % of the span
- **Pressure port:** Standard

Output signal	Electrical connection	Process connection	Seal	Measuring range	Type	Part no.
IO-Link/PNP + PNP	Round connector M12 x 1, 4-pin, IP67	G ¼ female	Without seal	-1 bar ... 1.5 bar	PBS-CB2X5SG2SSOLMA0Z	6048307
		G ¼ A according to DIN 3852-E	NBR	-1 bar ... 9 bar	PBS-CB010SG1SSNLMA0Z	6042806
2 x PNP + 4 mA ... 20 mA	Round connector M12 x 1, 5-pin, IP67	G ¼ A according to DIN 3852-E	NBR	-1 bar ... 9 bar	PBS-CB010SG1SSND5A0Z	6038922
				-1 bar ... 3 bar	PBS-CB4X0SG1SSND5A0Z	6038921
				-1 bar ... 1.5 bar	PBS-CB2X5SG1SSND5A0Z	6050311
				-1 bar ... 0 bar	PBS-CB1X0SG1SSND5A0Z	6038919
2 x PNP	Round connector M12 x 1, 4-pin, IP67	G ¼ female	Without seal	-1 bar ... 9 bar	PBS-CB010SG2SS0AMA0Z	6041541
				-1 bar ... 3 bar	PBS-CB4X0SG2SS0AMA0Z	6041048
				-1 bar ... 1.5 bar	PBS-CB2X5SG2SS0AMA0Z	6050312
				-1 bar ... 0 bar	PBS-CB1X0SG2SS0AMA0Z	6042360
		G ¼ A according to DIN 3852-E	NBR	-1 bar ... 9 bar	PBS-CB010SG1SSNAMA0Z	6038870
				-1 bar ... 3 bar	PBS-CB4X0SG1SSNAMA0Z	6038869
				-1 bar ... 1.5 bar	PBS-CB2X5SG1SSNAMA0Z	6044336
				-1 bar ... 0 bar	PBS-CB1X0SG1SSNAMA0Z	6038868
1 x PNP + 4 mA ... 20 mA	Round connector M12 x 1, 4-pin, IP67	G ¼ female	Without seal	-1 bar ... 9 bar	PBS-CB010SG2SS0BMA0Z	6041614
				-1 bar ... 3 bar	PBS-CB4X0SG2SS0BMA0Z	6042096
				-1 bar ... 1.5 bar	PBS-CB2X5SG2SS0BMA0Z	6042115
				-1 bar ... 0 bar	PBS-CB1X0SG2SS0BMA0Z	6047823
		G ¼ A according to DIN 3852-E	NBR	-1 bar ... 9 bar	PBS-CB010SG1SSNBMA0Z	6038896
				-1 bar ... 3 bar	PBS-CB4X0SG1SSNBMA0Z	6038895
				-1 bar ... 1.5 bar	PBS-CB2X5SG1SSNBMA0Z	6039523
				-1 bar ... 0 bar	PBS-CB1X0SG1SSNBMA0Z	6038894

PBS-CP

- Compound pressure
- **Output signal:** 2 x PNP
- **Electrical connection:** round connector M12 x 1, 4-pin, IP67
- **Process connection:** ¼" NPT
- **Seal:** without seal
- **Process temperature:** -20 °C ... +85 °C
- **Accuracy:** ≤ ± 1 % of the span
- **Pressure port:** Standard

Measuring range	Type	Part no.
-14.5 psi ... 160 psi	PBS-CP175SN1SS0AMA0Z	6044852
-14.5 psi ... 25 psi	PBS-CP040SN1SS0AMA0Z	6048034
-14.5 psi ... 15 psi	PBS-CP030SN1SS0AMA0Z	6047943
-14.5 psi ... 0 psi	PBS-CP015SN1SS0AMA0Z	6042106

PBS-RB

- Gauge pressure
- **Process temperature:** -20 °C ... +85 °C
- **Accuracy:** ≤ ± 1 % of the span

Output signal	Electrical connection	Process connection	Seal	Measuring range	Pressure port	Type	Part no.
IO-Link/PNP + PNP + 4 mA ... 20 mA	Round connector M12 x 1, 5-pin, IP67	G ¼ A according to DIN 3852-E	NBR	0 bar ... 1 bar	Standard	PBS-RB1X0SG1SSNQ5A0Z	6044667
IO-Link/PNP + PNP	Round connector M12 x 1, 4-pin, IP67	G ¼ female	Without seal	0 bar ... 400 bar	Standard	PBS-RB400SG2SS0LMA0Z	6045069
				0 bar ... 250 bar	Standard	PBS-RB250SG2SS0LMA0Z	6041626
				0 bar ... 100 bar	Standard	PBS-RB100SG2SS0LMA0Z	6041419
				0 bar ... 10 bar	Standard	PBS-RB010SG2SS0LMA0Z	6041418
				0 bar ... 1 bar	Standard	PBS-RB1X0SG2SS0LMA0Z	6050308
IO-Link/PNP + 4 mA ... 20 mA	Round connector M12 x 1, 4-pin, IP67	G ¼ female	Without seal	0 bar ... 100 bar	Standard	PBS-RB100SG2SS0NMA0Z	6049029
		G ¼ A according to DIN 3852-E	FKM/FPM	0 bar ... 250 bar	Standard	PBS-RB250SG1SSFNMA0Z	6050214
2 x PNP + 4 mA ... 20 mA	Round connector M12 x 1, 5-pin, IP67	G ¼ female	Without seal	0 bar ... 400 bar	Standard	PBS-RB400SG2SS0D5A0Z	6041595
				0 bar ... 250 bar	Standard	PBS-RB250SG2SS0D5A0Z	6041527
				0 bar ... 100 bar	Standard	PBS-RB100SG2SS0D5A0Z	6042526
				0 bar ... 10 bar	Standard	PBS-RB010SG2SS0D5A0Z	6039123
				0 bar ... 1 bar	Standard	PBS-RB1X0SG2SS0D5A0Z	6045265
		G ¼ A according to DIN 3852-E	NBR	0 bar ... 400 bar	Standard	PBS-RB400SG1SSND5A0Z	6042402
				0 bar ... 250 bar	Standard	PBS-RB250SG1SSND5A0Z	6038918
				0 bar ... 100 bar	Standard	PBS-RB100SG1SSND5A0Z	6038917
				0 bar ... 10 bar	Standard	PBS-RB010SG1SSND5A0Z	6038678
				0 bar ... 1 bar	Standard	PBS-RB1X0SG1SSND5A0Z	6038912

Output signal	Electrical connection	Process connection	Seal	Measuring range	Pressure port	Type	Part no.		
2 x PNP	Round connector M12 x 1, 4-pin, IP67	G ½ B flush mounted	NBR	0 bar ... 100 bar	Front-flush membrane	PBS-RB100SF2FSNAMA0Z	6049161		
				0 bar ... 16 bar	Front-flush membrane	PBS-RB016SF2FSNAMA0Z	6049845		
	Round connector M12 x 1, 4-pin, IP67	G ½ B flush mounted	NBR	0 bar ... 10 bar	Front-flush membrane	PBS-RB010SF2FSNAMA0Z	6049071		
				0 bar ... 2.5 bar	Front-flush membrane	PBS-RB2X5SF2FSNAMA0Z	6050186		
				G ¼ female	Without seal	0 bar ... 400 bar	Standard	PBS-RB400SG2SS0AMA0Z	6039495
						0 bar ... 250 bar	Standard	PBS-RB250SG2SS0AMA0Z	6039615
		0 bar ... 100 bar	Standard			PBS-RB100SG2SS0AMA0Z	6039614		
		0 bar ... 10 bar	Standard			PBS-RB010SG2SS0AMA0Z	6039110		
		G ¼ A according to DIN 3852-E	NBR	0 bar ... 1 bar	Standard	PBS-RB1X0SG2SS0AMA0Z	6041777		
				0 bar ... 400 bar	Standard	PBS-RB400SG1SSNAMA0Z	6041099		
				0 bar ... 250 bar	Standard	PBS-RB250SG1SSNAMA0Z	6038866		
				0 bar ... 100 bar	Standard	PBS-RB100SG1SSNAMA0Z	6038865		
				0 bar ... 10 bar	Standard	PBS-RB010SG1SSNAMA0Z	6038862		
				0 bar ... 1 bar	Standard	PBS-RB1X0SG1SSNAMA0Z	6038847		
		1 x PNP + 4 mA ... 20 mA	Round connector M12 x 1, 4-pin, IP67	G ½ B flush mounted	NBR	0 bar ... 100 bar	Front-flush membrane	PBS-RB100SF2FSNBMA0Z	6049761
						0 bar ... 16 bar	Front-flush membrane	PBS-RB016SF2FSNBMA0Z	6050168
0 bar ... 10 bar	Front-flush membrane					PBS-RB010SF2FSNBMA0Z	6049686		
G ¼ female	Without seal			0 bar ... 400 bar	Standard	PBS-RB400SG2SS0BMA0Z	6041019		
				0 bar ... 250 bar	Standard	PBS-RB250SG2SS0BMA0Z	6041053		
				0 bar ... 100 bar	Standard	PBS-RB100SG2SS0BMA0Z	6041615		
				0 bar ... 10 bar	Standard	PBS-RB010SG2SS0BMA0Z	6039121		
				0 bar ... 1 bar	Standard	PBS-RB1X0SG2SS0BMA0Z	6041279		
				G ¼ A according to DIN 3852-E	NBR	0 bar ... 400 bar	Standard	PBS-RB400SG1SSNBMA0Z	6041724
0 bar ... 250 bar	Standard					PBS-RB250SG1SSNBMA0Z	6038892		
0 bar ... 100 bar	Standard					PBS-RB100SG1SSNBMA0Z	6038891		
0 bar ... 10 bar	Standard					PBS-RB010SG1SSNBMA0Z	6038888		
0 bar ... 1 bar	Standard					PBS-RB1X0SG1SSNBMA0Z	6038885		

PBS-RP

- Gauge pressure
- **Process connection:** ¼" NPT
- **Seal:** without seal
- **Process temperature:** -20 °C ... +85 °C
- **Accuracy:** ≤ ± 1 % of the span
- **Pressure port:** Standard

Output signal	Electrical connection	Measuring range	Type	Part no.
IO-Link/PNP + PNP + 4 mA ... 20 mA	Round connector M12 x 1, 5-pin, IP67	0 psi ... 2,000 psi	PBS-RP2K0SN1SS0Q5A0Z	6044016

Output signal	Electrical connection	Measuring range	Type	Part no.
2 x PNP	Round connector M12 x 1, 4-pin, IP67	0 psi ... 5,000 psi	PBS-RP5K0SN1SS0AMA0Z	6048120
		0 psi ... 3,000 psi	PBS-RP3K0SN1SS0AMA0Z	6041560
		0 psi ... 1,500 psi	PBS-RP1K5SN1SS0AMA0Z	6048961
		0 psi ... 1,000 psi	PBS-RP1K0SN1SS0AMA0Z	6044565
		0 psi ... 500 psi	PBS-RP500SN1SS0AMA0Z	6048001
		0 psi ... 160 psi	PBS-RP160SN1SS0AMA0Z	6041223
		0 psi ... 100 psi	PBS-RP100SN1SS0AMA0Z	6041222
1 x PNP + 4 mA ... 20 mA	Round connector M12 x 1, 4-pin, IP67	0 psi ... 5,000 psi	PBS-RP5K0SN1SS0BMA0Z	6050310
		0 psi ... 3,000 psi	PBS-RP3K0SN1SS0BMA0Z	6049434
		0 psi ... 1,500 psi	PBS-RP1K5SN1SS0BMA0Z	6049723
		0 psi ... 1,000 psi	PBS-RP1K0SN1SS0BMA0Z	6041561
		0 psi ... 500 psi	PBS-RP500SN1SS0BMA0Z	6041562
		0 psi ... 160 psi	PBS-RP160SN1SS0BMA0Z	6050309
		0 psi ... 100 psi	PBS-RP100SN1SS0BMA0Z	6043695

Dimensional drawing (Dimensions in mm (inch))

PBS

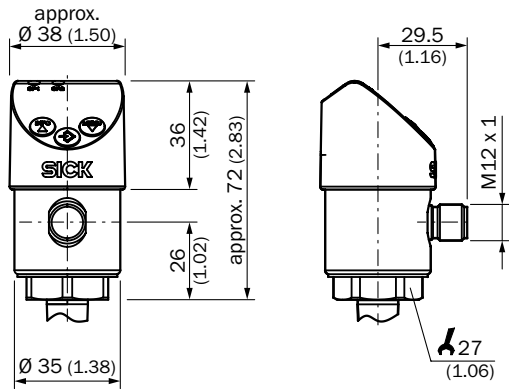

G ¼ A DIN 3852-E

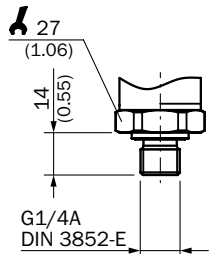

G ¼ female EN 837

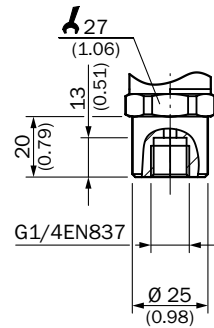

G ½ B according to EN 837

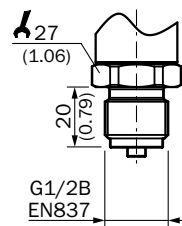

G ¼ female, compatible with Ermeto

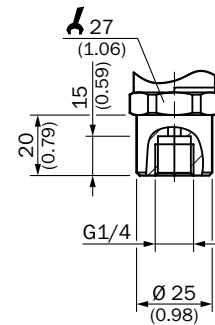

¼" NPT

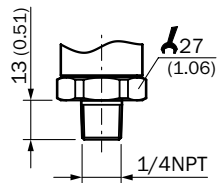

R ¼ ISO 7

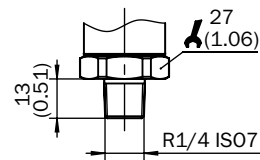

M20 x 1.5

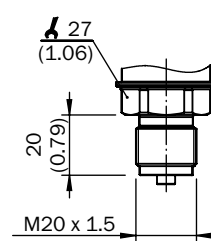

G ½ B flush mounted

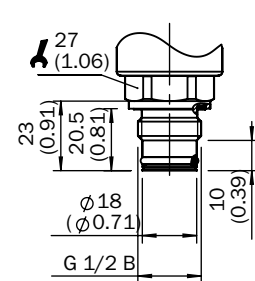

Recommended accessories

Mounting systems

Mounting brackets and plates

Mounting brackets

	Brief description	Type	Part no.
	Mounting bracket for simple and stable wall mounting of pressure sensors with 27 mm hexagon, Aluminum	BEF-FL-ALUPBS-HLDR	5322501

Device protection (mechanical)

Cooling elements

	Brief description	Type	Part no.
	Cooling element, extension of the process temperature up to 150 °C. Maximum ambient temperature 30 °C. Max. process pressure 200 bar. Not suitable for pressure measurement in steam. Outer thread G 1/2, inner thread G 1/2.	BEF-CE-G12G12-150C	5324393
	Cooling element, extension of the process temperature up to 200 °C. Maximum ambient temperature 30 °C. Max. process pressure 200 bar. Not suitable for pressure measurement in steam. Outer thread G 1/2, inner thread G 1/2.	BEF-CE-G12G12-200C	5324394
	Cooling element, extension of the process temperature up to 150 °C. Maximum ambient temperature 30 °C. Max. process pressure 200 bar. Not suitable for pressure measurement in steam. Outer thread G 1/4, inner thread G 1/2.	BEF-CE-G12G14-150C	5332155
	Cooling element, extension of the process temperature up to 200 °C. Maximum ambient temperature 30 °C. Max. process pressure 200 bar. Not suitable for pressure measurement in steam. Outer thread G 1/4, inner thread G 1/2.	BEF-CE-G12G14-200C	5336706

Connection systems



Modules and gateways

Fieldbus modules

	Brief description	Type	Part no.
	Number of IO-Link ports: 4; Communication mode: COM1/COM2; IO-Link version: IO-Link V1.0; Switching input: PNP; Supply voltage Vs, IO-Link ports: DC 24 V; Current loading: 800 mA; Data transmission rate: Max. 12 MBaud, Autobaud; Address space occupation: 1 bis 126; Connection type: Connector M12; Connection type, IO-Link ports: Connector M12, 5-pin; Supply voltage Vs, module: DC 18 ... 30 V; Power consumption: Typ. 75 mA / max. 100 mA (at UL with DC 24 V), Typ. 25 mA + sensor current / max. 80	IOLSHPB-P3104R01	6039728

Plug connectors and cables

Connecting cables with female connector

	Brief description	Cable length	Type	Part no.
	Head A: female connector, M12, 4-pin, straight Head B: open cable ends Cable: drag chain use, PUR, halogen-free, unshielded, 4.7 mm	2 m	DOL-1204-G02MC	6025900
	Head A: female connector, M12, 4-pin, straight Head B: open cable ends Cable: drag chain use, PUR, halogen-free, unshielded, Ø 4.7 mm	5 m	DOL-1204-G05MC	6025901
		10 m	DOL-1204-G10MC	6025902
	Head A: female connector, M12, 4-pin, angled Head B: open cable ends Cable: drag chain use, PUR, halogen-free, unshielded, Ø 4.7 mm	2 m	DOL-1204-W02MC	6025903
		5 m	DOL-1204-W05MC	6025904
		10 m	DOL-1204-W10MC	6025905

	Brief description	Cable length	Type	Part no.
 Illustration may differ	Head A: female connector, M12, 4-pin, straight Head B: open cable ends Cable: PVC, unshielded, Ø 5 mm	2 m	DOL-1204-G02M	6009382
		5 m	DOL-1204-G05M	6009866
		10 m	DOL-1204-G10M	6010543
		15 m	DOL-1204-G15M	6010753
 Illustration may differ	Head A: female connector, M12, 4-pin, angled Head B: open cable ends Cable: PVC, unshielded, Ø 5 mm	20 m	DOL-1204-G20M	6034401
		2 m	DOL-1204-W02M	6009383
		5 m	DOL-1204-W05M	6009867
		10 m	DOL-1204-W10M	6010541
		15 m	DOL-1204-W15M	6036474
 Illustration may differ	Head A: female connector, M12, 4-pin, angled Head B: open cable ends Cable: PVC, unshielded, Ø 5 mm	20 m	DOL-1204-W20M	6033559
		5 m	DOL-1204-W05MD	6020399

DOL-1204-G02MC
 DOL-1204-G05MC
 DOL-1204-G10MC

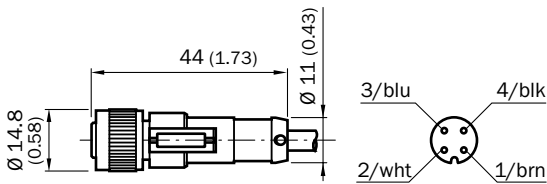

DOL-1204-W02MC
 DOL-1204-W05MC
 DOL-1204-W10MC

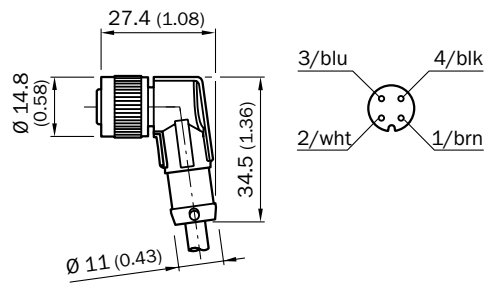

DOL-1204-G02M, DOL-1204-G05M, DOL-1204-G10M, DOL-1204-G15M, DOL-1204-G20M

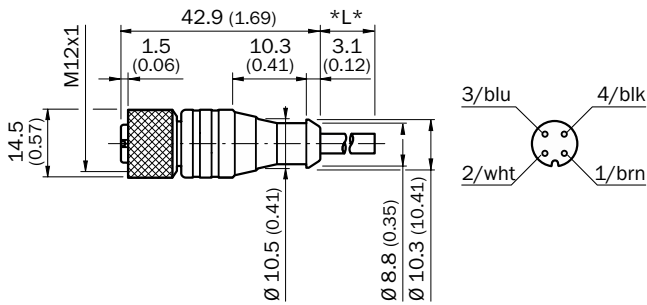

DOL-1204-W02M, DOL-1204-W05M, DOL-1204-W10M, DOL-1204-W15M, DOL-1204-W20M, DOL-1204-W05MD

