

# Bi-Colour LED, 5 mm



## Features

- Super Bright Red and Super Yellow Green chips are matched for uniform light output.
- Common Cathode.
- Long life solid state reliability.
- Low power consumption.
- I.C. compatible.
- Compliance with EU REACH.
- The product itself will remain within RoHS compliant Version.



## Descriptions:

- The lamp is a three leads bicolor light sources designed for a variety of applications where dual state illumination is required in the same package. There are two LED chips, high efficiency red, and high performance green (Yellow Green) mounted on a central common cathode lead for maximum on axis viewability. Colors between Red and Green can be generated by independently pulse width modulating the LED chips.

## Applications:

Computer / Communication / Consumer / Home Appliance / Industrial

## Absolute Maximum Ratings at Ta=25°C

Parameters	Symbol	Max.	Unit
Power Dissipation	Red	60	mW
	Yellow Green	60	
Peak Forward Current <sup>(a)</sup>	I <sub>FP</sub>	100	mA
DC Forward Current <sup>(b)</sup>	Red	25	mA
	Yellow Green	25	
Reverse Voltage	V <sub>R</sub>	5	V
Operating Temperature Range	T <sub>opr</sub>	-40°C to +80°C	
Storage Temperature Range	T <sub>stg</sub>	-40°C to +85°C	
Soldering Temperature	T <sub>slid</sub>	260°C for 5 Seconds	

Notes:

- Derate linearly as shown in derating curve.
- Duty Factor = 10%, Frequency = 1 kHz.

## Device Selection Guide

Part No.	Emitting Color	Lens Color
RND 135-00199	Super Bright Red	White Diffused
	Super Yellow Green	

# Bi-Colour LED, 5 mm



## Electrical Optical Characteristics at Ta=25°C

Parameters	Symbol	Emitting Color	Min.	Typ.	Max.	Unit	Test Condition
Luminous Intensity <sup>(a)</sup>	I <sub>v</sub>	Red	110	260	---	mcd	IF=20mA
		Yellow Green	30	70	---		
Viewing Angle <sup>(b)</sup>	2θ <sub>1/2</sub>	Red	---	60	---	deg.	IF=20mA
		Yellow Green	---	60	---		
Peak Emission Wavelength	λ <sub>p</sub>	Red	---	632	---	nm	IF=20mA
		Yellow Green	---	573	---		
Dominant Wavelength <sup>(c)</sup>	λ <sub>d</sub>	Red	---	624	---	nm	IF=20mA
		Yellow Green	---	571	---		
Spectral Line Half-Width	Δλ	Red	---	20	---	nm	IF=20mA
		Yellow Green	---	20	---		
Forward Voltage	V <sub>F</sub>	Red	1.6	2.0	2.4	V	IF=20mA
		Yellow Green	1.6	2.0	2.4		
Reverse Current	I <sub>R</sub>	Red	---	---	10	μA	V <sub>R</sub> =5V
		Yellow Green	---	---	10		

### Notes:

- Luminous intensity is measured with a light sensor and filter combination that approximates the CIE eye-response curve.
- 2θ<sub>1/2</sub> is the o-axis angle where the luminous intensity is 1/2 the peak intensity.
- The dominant wavelength (λ<sub>d</sub>) is derived from the CIE chromaticity diagram and represents the single wavelength which defines the color of the device.

# Bi-Colour LED, 5 mm

## Package Dimensions

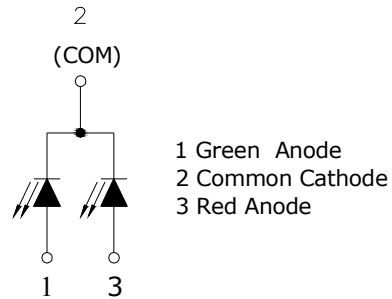
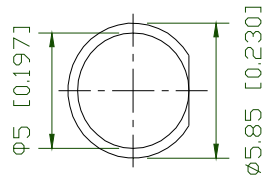

### POLARITY

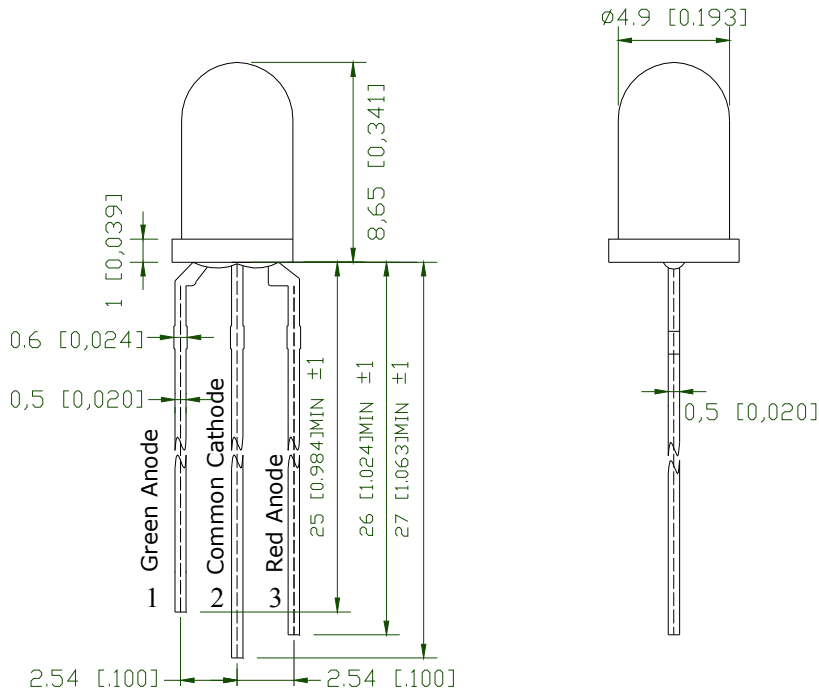

### Notes:

1. All dimensions are in millimeters (inches).
2. Tolerance is  $\pm 0.25$  mm (.010") unless otherwise noted.
3. Protruded resin under flange is 1.00mm (.039") max.

# Bi-Colour LED, 5 mm



## Typical Electrical / Optical Characteristics Curves (25°C Ambient Temperature Unless Otherwise Noted)

Red:

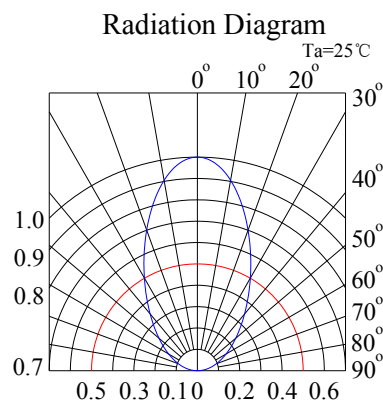
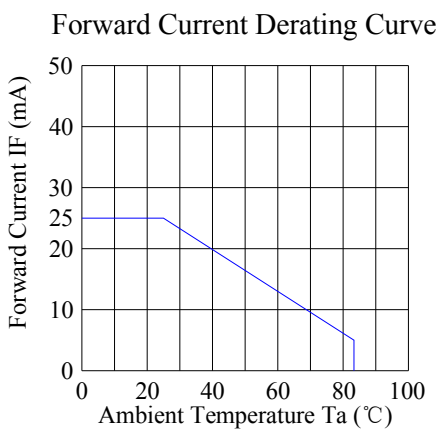
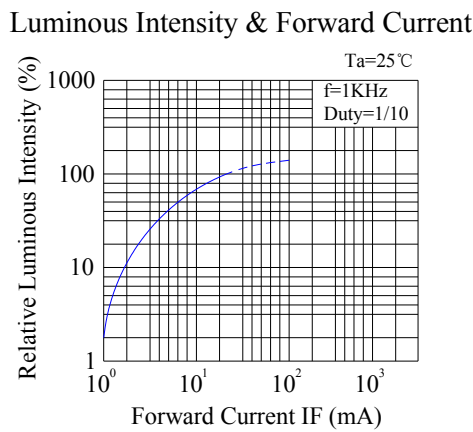
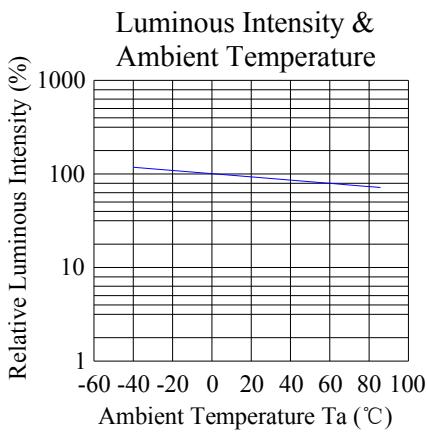
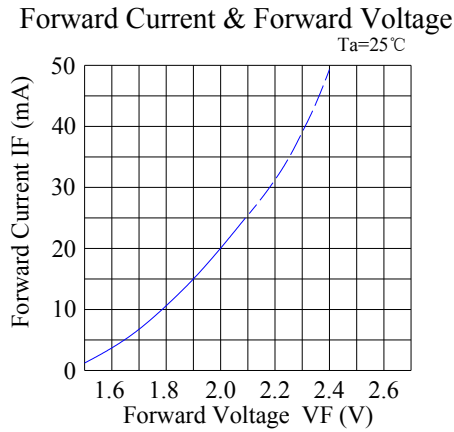
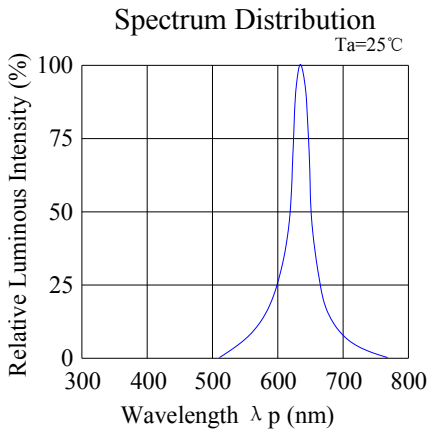

# Bi-Colour LED, 5 mm

## Yellow Green:

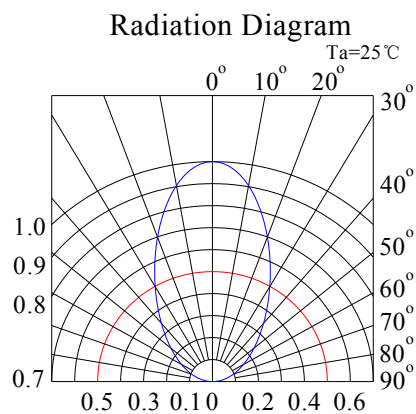
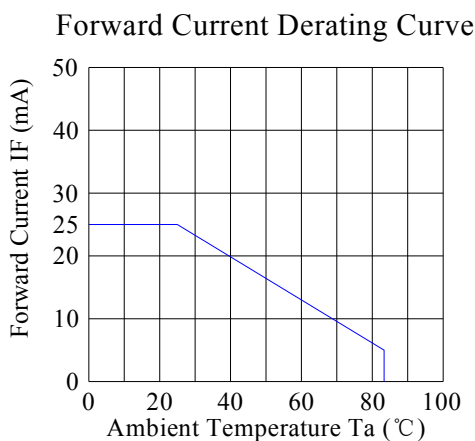
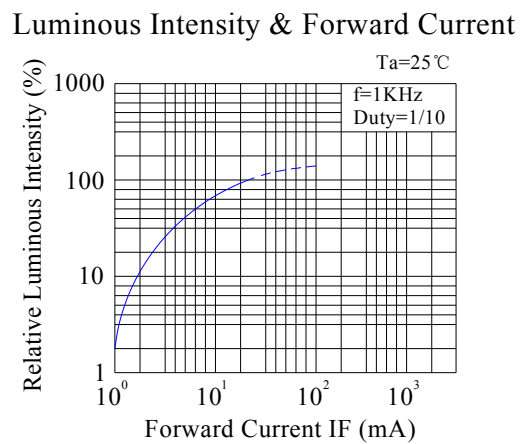
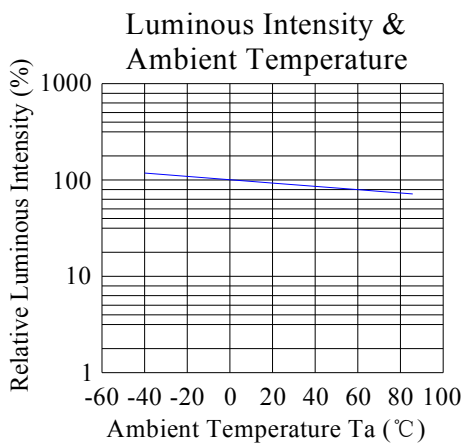
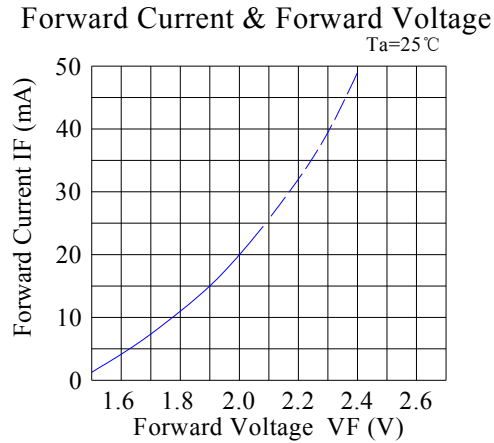
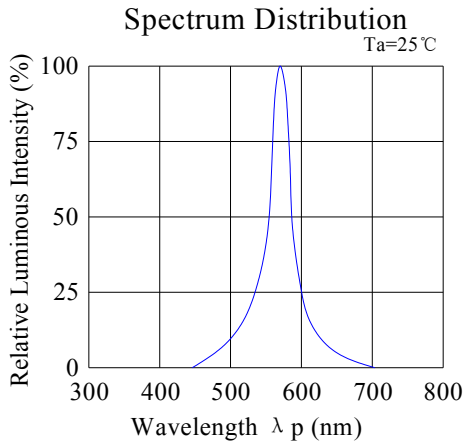

# Bi-Colour LED, 5 mm

## Cautions

### 1. Over-current-proof

Customer must apply resistors for protection, otherwise slight voltage shift will cause big current change (Burn out will happen).

### 2. Storage

2.1 The LEDs should be stored at 30°C or less and 70%RH or less after being shipped from RND and the storage life limits are 3 months. If the LEDs are stored for 3 months or more, they can be stored for a year in a sealed container with a nitrogen atmosphere and moisture absorbent material.

2.2 Please avoid rapid transitions in ambient temperature, especially, in high humidity environments where condensation can occur.

### 3. Cleaning

Use alcohol-based cleaning solvents such as isopropyl alcohol to clean the LEDs if necessary.

### 4. Lead Forming & Assembly

During lead forming, the leads should be bent at a point at least 1.6mm from the base of LED lens. Do not use the base of the lead frame as a fulcrum during forming. Lead forming must be done before soldering, at normal temperature. During assembly on PCB, use minimum clinch force possible to avoid excessive mechanical stress.

### 5. Soldering

When soldering, for Lamp without stopper type and must be leave a minimum of 3mm clearance from the base of the lens to the soldering point. Do not apply any external stress to the lead frame during soldering while the LED is at high temperature.

Recommended soldering conditions:

Soldering Iron		Wave Soldering	
Temperature	300°C Max. 3 sec. Max.	Pre-heat Pre-heat Time	100°C Max. 60 sec. Max.
Soldering Time	(one time only)	Solder Wave Soldering Time	260°C Max. 5 sec. Max.

Note: Excessive soldering temperature and / or time might result in deformation of the LED lens or catastrophic failure of the LED.

### 6. Drive Method

An LED is a current-operated device. In order to ensure intensity uniformity on multiple LEDs connected in parallel in an application, it is recommended that a current limiting resistor be incorporated in the drive circuit, in series with each LED as shown in Circuit A below.

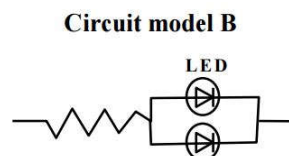
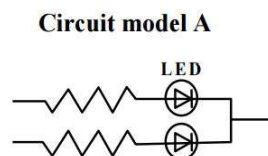

(A) Recommended circuit

(B) The brightness of each LED might appear different due to the differences in the I-V characteristics of those LEDs.

## 7. Repairing

Repair should not be done after the LEDs have been soldered. When repairing is unavoidable, a double-head soldering iron should be used. It should be confirmed beforehand whether the characteristics of the LEDs will or will not be damaged by repairing.

## 8. ESD (Electrostatic Discharge)

Static Electricity or power surge will damage the LED. Suggestions to prevent ESD damage:

8.1. Use a conductive wrist band or anti- electrostatic glove when handling these LEDs.

8.2. All devices, equipment, and machinery must be properly grounded.

8.3. Work tables, storage racks, etc. should be properly grounded.

8.4. Use ion blower to neutralize the static charge which might have built up on surface of the LEDs plastic lens as a result of friction between LEDs during storage and handing.

ESD-damaged LEDs will exhibit abnormal characteristics such as high reverse leakage current, low forward voltage, or “no light up” at low currents.

To verify for ESD damage, check for “light up” and VF of the suspect LEDs at low currents.

The VF of “good” LEDs should be  $>2.0V@0.1mA$  for InGaN product and  $>1.4V@0.1mA$  for AlInGaP product.

## 9. Others

9.1 The information included in this document reflects representative usage scenarios and is intended for technical reference only.

9.2 The part number, type, and specifications mentioned in this document are subject to future change and improvement without notice. Before production usage customer should refer to the latest datasheet for the updated specifications.

9.3 When using the products referenced in this document, please make sure the product is being operated within the environmental and electrical limits specified in the datasheet. If customer usage exceeds the specified limits, RND will not be responsible for any subsequent issues.

9.4 The LEDs described here are intended to be used for ordinary electronic equipment (such as office equipment, communication equipment and household applications). Consult RND Sales in advance for information on applications in which exceptional reliability is required, particularly when the failure or malfunction of the LEDs may directly jeopardize life or health, such as in aviation, transportation, traffic control equipment, medical and life support systems and safety devices.

Art. Nr.

RND 135-00199